



Hydraulic hose fittings and adapters
Raccordi e adattatori per tubi flessibili



Catalogue
Catalogo



HOSE FITTINGS RACCORDI PER TUBI FLESSIBILI





TIEFFE's main task is to manufacture and market a complete range of high quality and competitively priced hydraulic hose swage fittings, for both OEMs and after market.

L'obiettivo principale della TIEFFE è produrre una gamma completa di raccordi a pressione per tubo flessibile oleodinamico, di alta qualità e prezzo competitivo con quello dei migliori produttori mondiali, sia per il primo equipaggiamento che per la distribuzione.

TIEFFE is one of the major hydraulic hose fittings manufacturers in Europe.

TIEFFE è uno dei maggiori produttori europei di raccordi per tubo flessibile oleodinamico.

Fittings as well as production toolings are totally inhouse designed by our engineers working with modern CAD workstation. Design, Production Planning and Management, Quality Control workstations are all networked together.

Sia i raccordi che le attrezzature e gli utensili sono progettati internamente dai nostri tecnici utilizzando moderne stazioni CAD, collegate in rete con le stazioni dove vengono svolte le altre funzioni aziendali.





Starting from its founding partner's long personal involvement in hose assembling, TIEFFE has developed a specific Know-How and a marketing sensibility to improve in its connectors what is most important for the hose assembler.

Partendo dalla lunga esperienza diretta di raccordatura dei suoi fondatori, TIEFFE ha maturato l'esperienza e l'interesse a migliorare il prodotto negli aspetti più importanti per il raccordatore.

TIEFFE is very proud because some of the innovations it introduced to the market following long years of hard testing are now adopted by important competitors too.

Alcune delle innovazioni introdotte in passato da TIEFFE dopo lunghi studi sperimentali, sono ora utilizzate anche da molti importanti concorrenti.

TIEFFE is more and more the market leader in hose fittings and adapters.

TIEFFE è sempre più leader del mercato di raccordi e adattatori per tubi flessibili per oleodinamica.

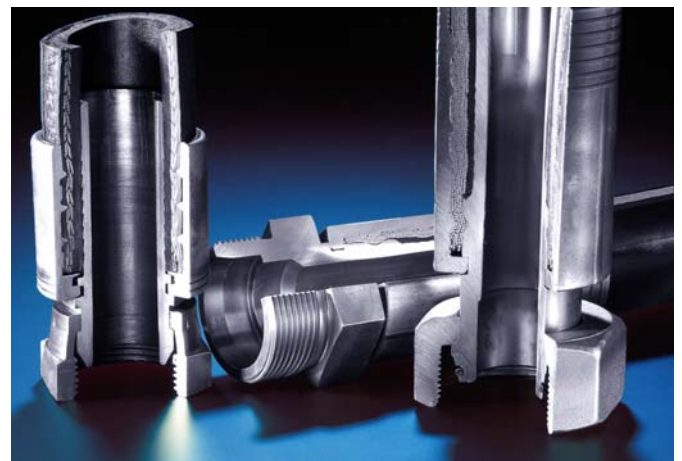

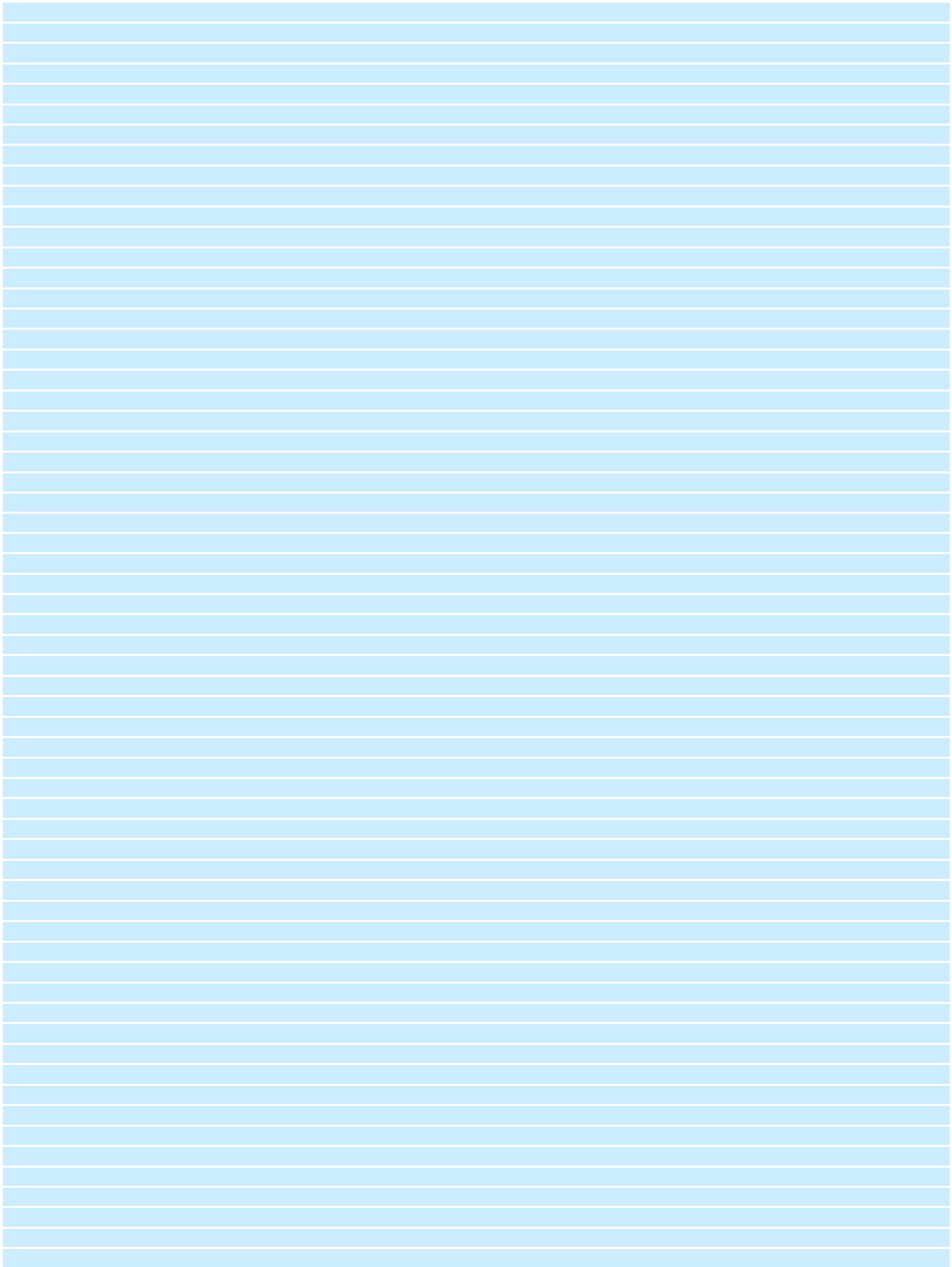

OBJECT - OGGETTO	PAGE
HOSE FITTINGS SELECTION - SCELTA DEI RACCORDI	7
"CX" SERIES VISUAL INDEX - INDICE FIGURATIVO SERIE "CX"	8-15
"CX" SERIES SWAGING DATA - DATI ASSEMBLAGGIO SERIE "CX"	73-79
"CS" SERIES VISUAL INDEX - INDICE FIGURATIVO SERIE "CS"	80-84
"CS" SERIES SWAGING DATA - DATI ASSEMBLAGGIO SERIE "CS"	108-109
"CH" SERIES VISUAL INDEX - INDICE FIGURATIVO SERIE "CH"	110-112
"CH" SERIES SWAGING DATA - DATI ASSEMBLAGGIO SERIE "CH"	124
"HX" SERIES VISUAL INDEX - INDICE FIGURATIVO SERIE "HX"	126-132
"HX" SERIES SWAGING DATA - DATI ASSEMBLAGGIO SERIE "HX"	183
"HSN" SERIES VISUAL INDEX - INDICE FIGURATIVO SERIE "HSN"	184-186
"HSN" SERIES SWAGING DATA - DATI ASSEMBLAGGIO SERIE "HSN"	209
"HSS" SERIES VISUAL INDEX - INDICE FIGURATIVO SERIE "HSS"	210-212
"HSS" SERIES SWAGING DATA - DATI ASSEMBLAGGIO SERIE "HSS"	229
THREAD IDENTIFICATION and TORQUE VALUES <i>IDENTIFICAZIONE FILETTATURE e VALORI COPPIE di SERRAGGIO</i>	230-232
INSTRUCTIONS for HOSE ASSEMBLIES <i>ISTRUZIONI per L'ASSEMBLAGGIO TUBI FLESSIBILI</i>	233
COLLAPSE CONTROL MANDRELS - SPINE di CONTROLLO COLLASSO	234

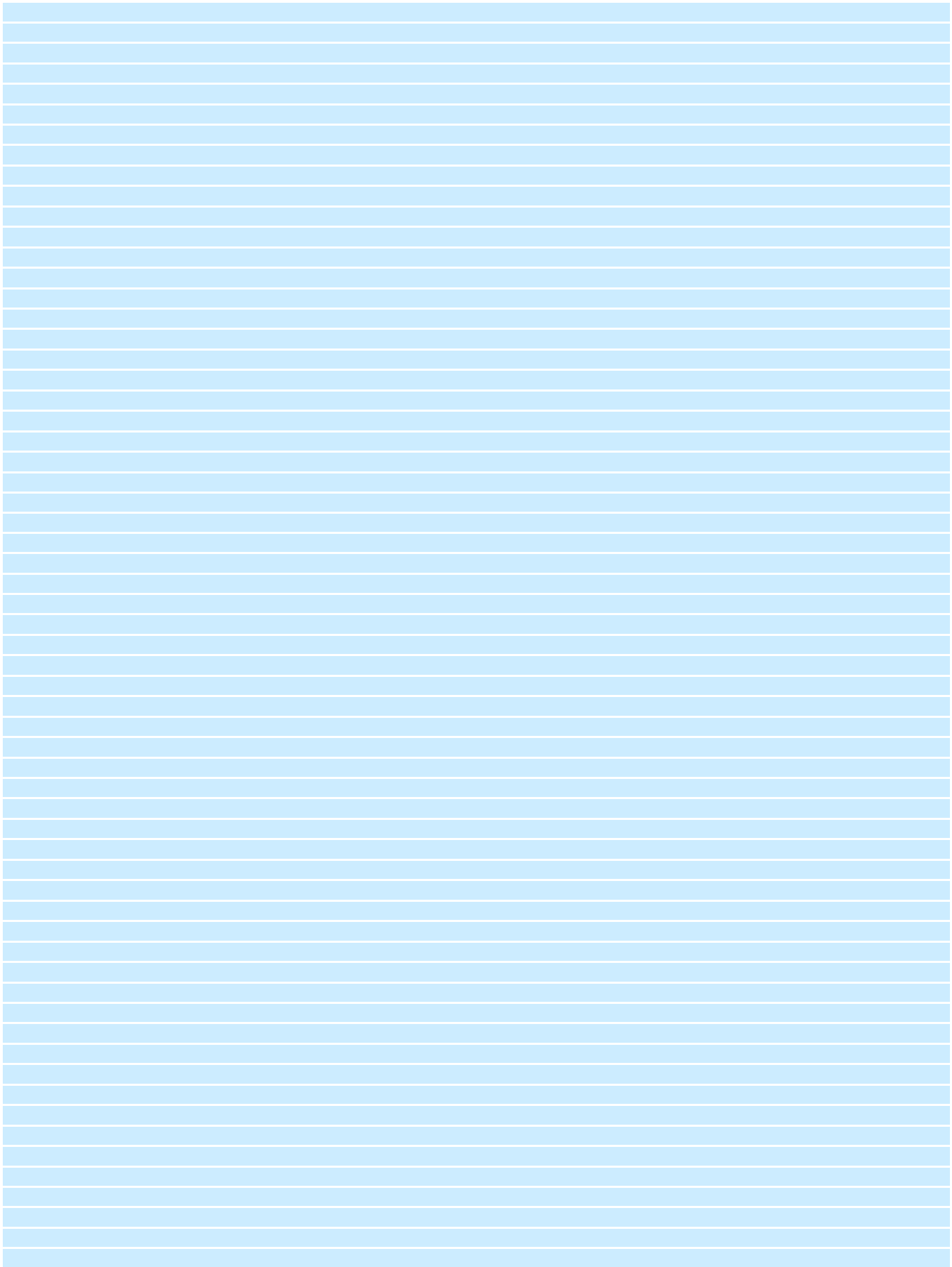

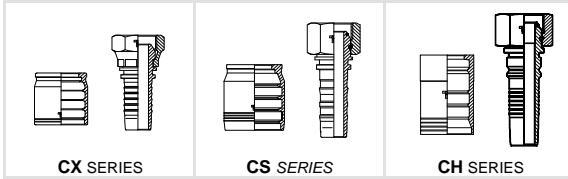
HOSE FITTINGS RANGE - GAMMA DEI RACCORDI
2 PIECES (2 PEZZI)
PRE-CRIMPED (PRE-PINZATI)

**HYDRAULIC HOSES
TUBI IDRAULICI**
**FITTINGS SELECTION BY HOSE SIZE
SCELTA DEI RACCORDI PER DIAMETRO TUBO**

DN 5	DN 6,3	DN 8	DN 10	DN 12,5	DN 16	DN 19	DN 25	DN 31,5	DN 38	DN 51
------	--------	------	-------	---------	-------	-------	-------	---------	-------	-------

RUBBER HOSES STEEL WIRE BRAIDED
TUBI GOMMA TRECCIATI ACCIAIO

ISO 1436 1SN-R1ATS SAE100 R1AT-R1ATS	CX-HX	CX-HX	CX-HX	CX-HX	CX-HX	CX-HX	CX-HX	CX-HX	CX-HX	CX-HX	CX-HX
ISO 1436 2SN-R2ATS SAE100 R2AT-R2ATS	CX-HX	CX-HX	CX-HX	CX-HX	CX-HX	CX-HX	CX-HX	CX-HX	CX-HX	CX-HX	CX-HX
ISO 11237 1SC		CX-HX	CX-HX	CX-HX	CX-HX	CX-HX	CX-HX	CX-HX			
ISO 11237 2SC		CX-HX	CX-HX	CX-HX	CX-HX	CX-HX	CX-HX	CX-HX	CX-HX		
ISO 11237 R16S SAE100 R16-R16S		CX-HX	CX-HX	CX-HX	CX-HX	CX-HX	CX-HX	CX-HX	CX-HX		
ISO 11237 R17 SAE100 R17		CX-HX	CX-HX	CX-HX	CX-HX	CX-HX	CX-HX	CX-HX			
ISO 11237 R19 SAE100 R19		CX-HX	CX-HX	CX-HX	CX-HX	CX-HX	CX-HX				

RUBBER HOSES STEEL WIRE SPIRAL
TUBI GOMMA SPIRALATI ACCIAIO

ISO 3862 4SP		CX		CX	CX	CX	CX-CS HSN	CX-CS HSN	CX-CS HSS	CX-CS HSS	CX-CS HSS
ISO 3862 4SH							CX-CS CH-HSN	CX-CS CH-HSN	CX-CS CH-HSN	CX-CS CH-HSN	CX-CS CH-HSN
ISO 3862 R12 SAE100 R12				CX	CX	CX	CX-CS HSN	CX-CS HSN	CX-CS HSN	CX-CS HSN	CX-CS HSN
ISO 3862 R13 SAE100 R13							CS-CH HSN	CS-CH HSN	CS-CH HSS	CS-CH HSS	CS-CH HSS
ISO 3862 R15 SAE100 R15							CS-CH HSN	CS-CH HSN	CS-CH HSS	CS-CH HSS	











RUBBER HOSES TEXTILE BRAIDED
TUBI GOMMA TRECCIATI TESSILI

ISO 4079 1TE	CX	CX	CX	CX	CX	CX					
ISO 4079 2TE	CX	CX	CX	CX	CX	CX	CX	CX			
ISO 4079 3TE	CX	CX	CX	CX	CX	CX	CX	CX	CX	CX	CX
ISO 4079 R6 SAE100 R6	CX	CX	CX	CX	CX	CX	CX				
ISO 4079 R3 SAE100 R3	CX	CX	CX	CX	CX	CX	CX	CX	CX		













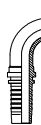

THERMOPLASTIC HOSES
TUBI TERMOPLASTICI

ISO 3949 R7 SAE100 R7	CX	CX	CX	CX	CX	CX	CX	CX			
ISO 3949 R8 SAE100 R8	CX	CX	CX	CX	CX	CX	CX	CX			
ISO 3949 R18 SAE100 R18	CX	CX	CX	CX	CX	CX	CX	CX			

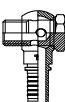

FERRULES

REFERENCE	DESCRIPTION	PAGE	REFERENCE	DESCRIPTION	PAGE
BXC	 <p>NO-SKIVE FERRULE FOR WIRE BRAID COMPACT HOSES BOCCOLA PER TUBI TRECCIATI COMPATTI SENZA PELATURA</p>	16	BXT4	 <p>NO-SKIVE FERRULE FOR SPIRAL HOSES BOCCOLA PER TUBI SPIRALATI SENZA PELATURA</p>	18
BXT1	 <p>NO-SKIVE FERRULE FOR WIRE BRAID HOSES BOCCOLA PER TUBI TRECCIATI SENZA PELATURA</p>	16	BXS	 <p>SKIVE FERRULE FOR SPIRAL HOSES BOCCOLA PER TUBI SPIRALATI CON PELATURA</p>	18
BXT2	 <p>NO-SKIVE FERRULE FOR WIRE BRAID HOSES BOCCOLA PER TUBI TRECCIATI SENZA PELATURA</p>	16	BXSH	 <p>SKIVE FERRULE FOR SPIRAL HOSES BOCCOLA PER TUBI SPIRALATI CON PELATURA</p>	18
BXLP	 <p>SKIVE FERRULE FOR WIRE BRAID HOSES BOCCOLA PER TUBI TRECCIATI CON PELATURA</p>	17	BX7	 <p>NO-SKIVE FERRULE FOR THERMOPLASTIC and TEXTILE BRAID HOSES BOCCOLA PER TUBI TERMOPLSTICI E TRECCIATI TESSILI SENZA PELATURA</p>	19
BXL	 <p>SKIVE FERRULE FOR WIRE BRAID HOSES BOCCOLA PER TUBI TRECCIATI CON PELATURA</p>	17	BX8	 <p>NO-SKIVE FERRULE FOR THERMOPLASTIC BRAID HOSES BOCCOLA PER TUBI TRECCIATI TERMOPLSTICI SENZA PELATURA</p>	19
BXP	 <p>SKIVE FERRULE FOR WIRE BRAID HOSES BOCCOLA PER TUBI TRECCIATI CON PELATURA</p>	17	BP3	 <p>NO-SKIVE FERRULE FOR TEXTILE BRAID HOSES BOCCOLA PER TUBI TRECCIATI TESSILI SENZA PELATURA</p>	19





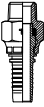

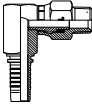
BRITISH STANDARD CONNECTIONS

REFERENCE	DESCRIPTION	PAGE	REFERENCE	DESCRIPTION	PAGE
CX-MGC	 <p>BSP TAPERED MALE 60° CONE SEAT MASCHIO GAS CONICO SVASATO 60°</p>	20	CX-FGP90K	 <p>BSP FEMALE 60° CONE 90° COMPACT ELBOW CRIMPED-BACK NUT BS 5200 - ISO 12151-6 FEMMINA GAS OGIVA 60° CURVA COMPATTA 90° - DADO PRESSATO BS 5200 - ISO 12151-6</p>	25
CX-MG	 <p>BSP PARALLELE MALE 60° CONE SEAT BS 5200 - ISO 12151-6 MASCHIO GAS CILINDRICO SVASATO 60° BS 5200 - ISO 12151-6</p>	21	CX-FGOL CX-FGOS	 <p>BSP FEMALE 60° O'RING CONE FULL EXGON NUT BS 5200 - ISO 12151-6 FEMMINA GAS OGIVA 60° O'RING DADO TUTTO ESAGONO BS 5200 - ISO 12151-6</p>	26
CX-FGP	 <p>BSP FEMALE 60° CONE CRIMPED-BACK NUT BS 5200 - ISO 12151-6 FEMMINA GAS - OGIVA 60° DADO PRESSATO BS 5200 - ISO 12151-6</p>	22	CX-FGOL45 CX-FGOS45	 <p>BSP FEMALE 60° O'RING CONE 45° ELBOW - FULL EXGON NUT BS 5200 - ISO 12151-6 FEMMINA GAS OGIVA 60° O-RING CURVA A 45° - DADO TUTTO ESAGONO BS 5200 - ISO 12151-6</p>	27
CX-FGL CX-FGS	 <p>BSP FEMALE 60° CONE FULL EXGON NUT BS 5200 - ISO 12151-6 FEMMINA GAS OGIVA 60° DADO TUTTO ESAGONO BS 5200 - ISO 12151-6</p>	22	CX-FGOL90 CX-FGOS90	 <p>BSP FEMALE 60° O'RING CONE 90° ELBOW - FULL EXGON NUT BS 5200 - ISO 12151-6 FEMMINA GAS OGIVA 60° O-RING CURVA A 90° - DADO TUTTO ESAGONO BS 5200 - ISO 12151-6</p>	27
CX-FGP45	 <p>BSP FEMALE 60° CONE 45° ELBOW - CRIMPED-BACK NUT BS 5200 - ISO 12151-6 FEMMINA GAS OGIVA 60° CURVA A 45° - DADO PRESSATO BS 5200 - ISO 12151-6</p>	23	CX-MGF	 <p>BSP PARALLELE MALE FLAT SEAT MASCHIO GAS CILINDRICO SEDE PIANA</p>	28
CX-FGL45 CX-FGS45	 <p>BSP FEMALE 60° CONE 45° ELBOW - FULL EXGON NUT BS 5200 - ISO 12151-6 FEMMINA GAS OGIVA 60° CURVA A 45° - DADO TUTTO ESAGONO BS 5200 - ISO 12151-6</p>	23	CX-FGF	 <p>BSP FEMALE FLAT SEAT CRIMPED-BACK NUT FEMMINA GAS SEDE PIANA DADO PRESSATO</p>	28
CX-FGP90	 <p>BSP FEMALE 60° CONE 90° ELBOW - CRIMPED-BACK NUT BS 5200 - ISO 12151-6 FEMMINA GAS OGIVA 60° CURVA A 90° - DADO PRESSATO BS 5200 - ISO 12151-6</p>	24	CX-OG	 <p>BSP BANJO OCCHIO GAS</p>	29
CX-FGL90 CX-FGS90	 <p>BSP FEMALE 60° CONE 90° ELBOW - FULL EXGON NUT BS 5200 - ISO 12151-6 FEMMINA GAS OGIVA 60° CURVA A 90° - DADO TUTTO ESAGONO BS 5200 - ISO 12151-6</p>	24	06VS-	 <p>BSP BANJO BOLT VITE FORATA GAS</p>	29

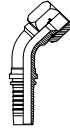

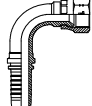
AMERICAN STANDARD CONNECTIONS - NPTF - NPSM

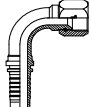
REFERENCE	DESCRIPTION	PAGE	REFERENCE	DESCRIPTION	PAGE
 CX-NPT	NPTF MALE 60° CONE SEAT SAE J516 <i>MASCHIO NPTF SVASATO 60°</i> SAE J516	30	 CX-SPT	NPTF SWIVEL MALE 60° CONE SEAT <i>MASCHIO GIREVOLE NPTF SVASATO 60°</i>	31
 CX-FSM	NPSM FEMALE 60° CONE <i>FEMMINA NPSM OGOVA 60°</i>	30	 CX-SPT90	NPTF SWIVEL MALE 60° CONE SEAT 90° COMPACT ELBOW <i>MASCHIO GIREVOLE NPTF SVASATO 60°</i> <i>CURVA 90° COMPATTA</i>	31

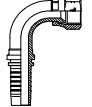
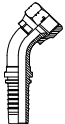
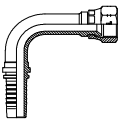

AMERICAN STANDARD CONNECTIONS - JIC 37° (SAE J516 / ISO 12151-5)

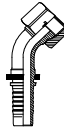
REFERENCE	DESCRIPTION	PAGE	REFERENCE	DESCRIPTION	PAGE
 CX-MI	JIC MALE 37° CONE <i>MASCHIO JIC CONO 37°</i>	32	 CX-FIS45	JIC FEMALE 37° CONE SEAT 45° ELBOW - TIEFFE NUT <i>FEMMINA JIC SVASATA 37°</i> <i>CURVA A 45° - DADO TIEFFE</i>	35
 CX-FIP	JIC FEMALE 37° CONE SEAT CRIMPED-BACK NUT <i>FEMMINA JIC SVASATA 37°</i> <i>DADO PRESSATO</i>	33	 CX-FIP90	JIC FEMALE 37° CONE SEAT 90° ELBOW - CRIMPED-BACK NUT <i>FEMMINA JIC SVASATA 37°</i> <i>CURVA A 90° - DADO PRESSATO</i>	36
 CX-FICP	JIC FEMALE 37° CONE SEAT DOUBLE EXAGON - CRIMPED-BACK NUT <i>FEMMINA JIC SVASATA 37°</i> <i>DOPPIO ESAGONO - DADO PRESSATO</i>	34	 CX-FIS90	JIC FEMALE 37° CONE SEAT 90° ELBOW - TIEFFE NUT <i>FEMMINA JIC SVASATA 37°</i> <i>CURVA A 90° - DADO TIEFFE</i>	36
 CX-FICS	JIC FEMALE 37° CONE SEAT DOUBLE EXAGON - TIEFFE NUT <i>FEMMINA JIC SVASATA 37°</i> <i>DOPPIO ESAGONO - DADO TIEFFE</i>	34	 CX-FIP90C	JIC FEMALE 37° CONE SEAT 90° ELBOW - SHORT DROP CRIMPED-BACK NUT <i>FEMMINA JIC SVASATA 37°</i> <i>CURVA A 90° - CORTA</i> <i>DADO PRESSATO</i>	37
 CX-FIP45	JIC FEMALE 37° CONE SEAT 45° ELBOW - CRIMPED-BACK NUT <i>FEMMINA JIC SVASATA 37°</i> <i>CURVA A 45° - DADO PRESSATO</i>	35	 CX-FIP90L	JIC FEMALE 37° CONE SEAT 90° ELBOW - LONG DROP CRIMPED-BACK NUT <i>FEMMINA JIC SVASATA 37°</i> <i>CURVA A 90° - LUNGA</i> <i>DADO PRESSATO</i>	37

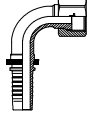
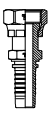
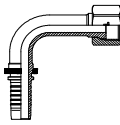
AMERICAN STANDARD CONNECTIONS - ORFS (SAE J516 / ISO 12151-1)

REFERENCE	DESCRIPTION	PAGE	REFERENCE	DESCRIPTION	PAGE
 CX-MRS	ORFS MALE MASCHIO ORFS	38	 CX-FRS45	ORFS FEMALE 45° ELBOW - SLIP-ON NUT FEMMINA ORFS CURVA A 45° - DADO LIBERO	40
 CX-FRS	ORFS FEMALE SLIP-ON NUT FEMMINA ORFS DADO LIBERO	39	 CX-FRS90C	ORFS FEMALE 90° ELBOW - SHORT DROP SLIP-ON NUT FEMMINA ORFS CURVA A 90° - CORTA DADO LIBERO	41
 CX-FRC	ORFS FEMALE DOUBLE EXAGON - CRIMPED-BACK NUT FEMMINA ORFS DOPPIO ESAGONO - DADO PRESSATO	39	 CX-FRS90L	ORFS FEMALE 90° ELBOW - LONG DROP SLIP-ON NUT FEMMINA ORFS CURVA A 90° - LUNGA DADO LIBERO	41

AMERICAN STANDARD CONNECTIONS - SAE

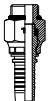
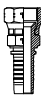
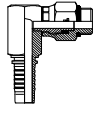
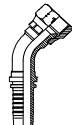
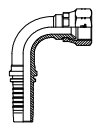
REFERENCE	DESCRIPTION	PAGE	REFERENCE	DESCRIPTION	PAGE
 CX-MS	SAE O-RING BOSS MALE SAE J516 MASCHIO SAE O-RING SAE J516	42	 CX-MJ	SAE MALE 45° CONE SAE J513 MASCHIO SAE CONO 45° SAE J513	43
 CX-SMS	SAE O-RING BOSS SWIVEL MALE MASCHIO GIREVOLE SAE O-RING	42	 CX-FJCP	SAE FEMALE 45° CONE SEAT DOUBLE EXAGON - CRIMPED BACK NUT SAE J513 FEMMINA SAE SVASATA 45° DOPPIO ESAGONO - DADO PRESSATO SAE J513	43
 CX-SMS90	SAE O-RING BOSS SWIVEL MALE 90° COMPACT ELBOW MASCHIO GIREVOLE SAE O-RING CURVA A 90° COMPATTA	42	 CX-FJP45	SAE FEMALE 45° CONE SEAT 45° ELBOW - CRIMPED BACK NUT SAE J513 FEMMINA SAE SVASATA 45° CURVA A 45° - DADO PRESSATO SAE J513	43
			 CX-FJP90	SAE FEMALE 45° CONE SEAT 90° ELBOW - CRIMPED BACK NUT SAE J513 FEMMINA SAE SVASATA 45° CURVA A 90° - DADO PRESSATO SAE J513	43

AMERICAN STANDARD CONNECTIONS - FLANGE CODE 61 (SAE J516 / ISO 12151-3)

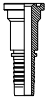
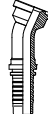
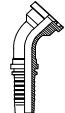
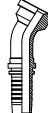
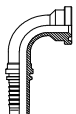
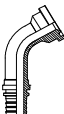
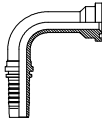
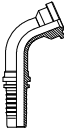
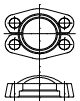
REFERENCE	DESCRIPTION	PAGE	REFERENCE	DESCRIPTION	PAGE
 CX-FL	SAE CODE 61 FLANGE FLANGIA SAE CODE 61	44	 CX-FL22	SAE CODE 61 FLANGE 22,5° ELBOW FLANGIA SAE CODE 61 CURVA A 22,5°	46
 CX-FL45	SAE CODE 61 FLANGE 45° ELBOW FLANGIA SAE CODE 61 CURVA A 45°	44	 CX-FL30	SAE CODE 61 FLANGE 30° ELBOW FLANGIA SAE CODE 61 CURVA A 30°	46
 CX-FL90	SAE CODE 61 FLANGE 90° ELBOW FLANGIA SAE CODE 61 CURVA A 90°	45	 CX-FL60	SAE CODE 61 FLANGE 60° ELBOW FLANGIA SAE CODE 61 CURVA A 60°	47
 CX-FL90-K-	SAE CODE 61 FLANGE 90° ELBOW - LONG DROP FLANGIA SAE CODE 61 CURVA A 90° - LUNGA	45	 CX-FL67	SAE CODE 61 FLANGE 67,5° ELBOW FLANGIA SAE CODE 61 CURVA A 67,5°	47
			 13SL-	SAE CODE 61 SPLIT FLANGE CLAMPS SAE J518 - ISO 6162-1 COPPIA SEMIFLANGE SAE CODE 61 SAE J518 - ISO 6162-1	48

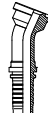
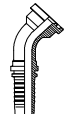
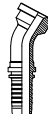
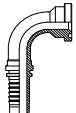
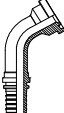
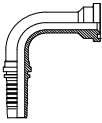
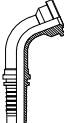
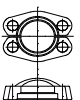

AMERICAN STANDARD CONNECTIONS - FLANGE CODE 62 (SAE J516 / ISO 12151-3)

REFERENCE	DESCRIPTION	PAGE	REFERENCE	DESCRIPTION	PAGE
 CX-FP	SAE CODE 62 FLANGE FLANGIA SAE CODE 62	49	 CX-FP22	SAE CODE 62 FLANGE 22,5° ELBOW FLANGIA SAE CODE 62 CURVA A 22,5°	51
 CX-FP45	SAE CODE 62 FLANGE 45° ELBOW FLANGIA SAE CODE 62 CURVA A 45°	49	 CX-FP30	SAE CODE 62 FLANGE 30° ELBOW FLANGIA SAE CODE 62 CURVA A 30°	51
 CX-FP90	SAE CODE 62 FLANGE 90° ELBOW FLANGIA SAE CODE 62 CURVA A 90°	50	 CX-FP60	SAE CODE 62 FLANGE 60° ELBOW FLANGIA SAE CODE 62 CURVA A 60°	52
 CX-FP90-K-	SAE CODE 62 FLANGE 90° ELBOW - LONG DROP FLANGIA SAE CODE 62 CURVA A 90° - LUNGA	50	 CX-FP67	SAE CODE 62 FLANGE 67,5° ELBOW FLANGIA SAE CODE 62 CURVA A 67,5°	52
			 13SP-	SAE CODE 62 SPLIT FLANGE CLAMPS SAE J518 - ISO 6162-2 COPPIA SEMIFLANGE SAE CODE 62 SAE J518 - ISO 6162-2	53

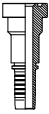
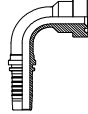
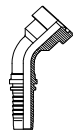







OEM CONNECTIONS - "SUPERCAT" FLANGE

REFERENCE	DESCRIPTION	PAGE	REFERENCE	DESCRIPTION	PAGE
CX-YP	 <p>"SUPERCAT" FLANGE FLANGIA "SUPERCAT"</p>	54	CX-YP90	 <p>"SUPERCAT" FLANGE 90° ELBOW FLANGIA "SUPERCAT" CURVA A 90°</p>	54
CX-YP45	 <p>"SUPERCAT" FLANGE 45° ELBOW FLANGIA "SUPERCAT" CURVA A 45°</p>	54			



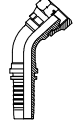
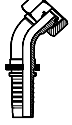
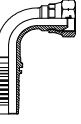
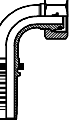
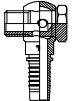

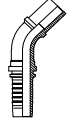
JAPANESE STANDARD CONNECTIONS (JIS B8363)

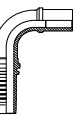
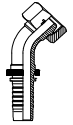
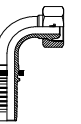
REFERENCE	DESCRIPTION	PAGE	REFERENCE	DESCRIPTION	PAGE
CX-FGCP	 <p>"NISSAN" BSP FEMALE 60° CONE - DOUBLE EXAGON CRIMPED BACK NUT FEMMINA GAS "NISSAN" OGIVA 60° - DOPPIO ESAGONO DADO PRESSATO</p>	55	CX-FMG	 <p>"KOMATSU" METRIC FEMALE 60° CONE SEAT - DOUBLE EXAGON CRIMPED BACK NUT FEMMINA METRICA "KOMATSU" SVASATA 60° - DOPPIO ESAGONO DADO PRESSATO</p>	55
CX-FTC	 <p>"TOYOTA" BSP FEMALE 60° CONE SEAT - DOUBLE EXAGON CRIMPED BACK NUT FEMMINA GAS "TOYOTA" SVASATA 60° - DOPPIO ESAGONO DADO PRESSATO</p>	55			

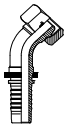

DIN STANDARD CONNECTIONS

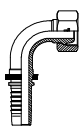
REFERENCE	DESCRIPTION	PAGE	REFERENCE	DESCRIPTION	PAGE
CX-MW	 <p>METRIC MALE 60° CONE SEAT DIN 3863 MASCHIO METRICO SVASATO 60° DIN 3863</p>	56	CX-MM	 <p>METRIC MALE 24° CONE SEAT DIN 20066 - ISO 12151-2 MASCHIO METRICO SVASATO 24° DIN 20066 - ISO 12151-2</p>	62
CX-FW	 <p>METRIC FEMALE 60° CONE CRIMPED-BACK NUT DIN 3863 / 20078 FEMMINA METRICA OGIVA 60° DADO PRESSATO DIN 3863 / 20078</p>	57	CX-FOS	 <p>METRIC FEMALE 24° O'RING CONE SLIP-ON NUT DIN 20066 - ISO 12151-2 FEMMINA METRICA OGIVA 24° O'RING DADO LIBERO DIN 20066 - ISO 12151-2</p>	63
CX-FW45	 <p>METRIC FEMALE 60° CONE 45° ELBOW - CRIMPED BACK NUT DIN 3863 / 20078 FEMMINA METRICA OGIVA 60° CURVA A 45° - DADO PRESSATO DIN 3863 / 20078</p>	58	CX-FOS45	 <p>METRIC FEMALE 24° O'RING CONE 45° ELBOW - SLIP-ON NUT DIN 20066 - ISO 12151-2 FEMM. METR. OGIVA 24° O'RING CURVA A 45° - DADO LIBERO DIN 20066 - ISO 12151-2</p>	64
CX-FW90	 <p>METRIC FEMALE 60° CONE 90° ELBOW - CRIMPED BACK NUT DIN 3863 / 20078 FEMMINA METRICA OGIVA 60° CURVA A 90° - DADO PRESSATO DIN 3863 / 20078</p>	59	CX-FOS90	 <p>METRIC FEMALE 24° O'RING CONE 90° ELBOW - SLIP-ON NUT DIN 20066 - ISO 12151-2 FEMM. METR. OGIVA 24° O'RING CURVA A 90° - DADO LIBERO DIN 20066 - ISO 12151-2</p>	65
CX-OM	 <p>METRIC BANJO OCCHIO METRICO</p>	60	CX-ET	 <p>METRIC STANDPIPE DIN 2353 - ISO 8434-1 ESTREMITA' TUBOLARE METRICA DIN 2353 - ISO 8434-1</p>	66
06VS-	 <p>METRIC BANJO BOLT VITE FORATA METRICA</p>	60	CX-ET45	 <p>METRIC STANDPIPE 45° ELBOW DIN 2353 - ISO 8434-1 ESTREMITA' TUBOLARE METRICA CURVA A 45° - ISO 8434-1</p>	67
CX-FM	 <p>METRIC FEMALE MULTISEAL SLIP-ON NUT DIN 3868 / 20078 FEMMINA METRICA MULTISEAL DADO LIBERO DIN 3868 / 20078</p>	61	CX-ET90	 <p>METRIC STANDPIPE 90° ELBOW DIN 2353 - ISO 8434-1 ESTREMITA' TUBOLARE METRICA CURVA A 90° - ISO 8434-1</p>	68
CX-FM45	 <p>METRIC FEMALE MULTISEAL 45° ELBOW - SLIP-ON NUT DIN 3868 / 20078 FEMM. METRICA MULTISEAL CURVA A 45° - DADO LIBERO DIN 3868 / 20078</p>	61			
CX-FM90	 <p>METRIC FEMALE MULTISEAL 90° ELBOW - SLIP-ON NUT DIN 3868 / 20078 FEMM. METRICA MULTISEAL CURVA A 90° - DADO LIBERO DIN 3868 / 20078</p>	61			

FRENCH STANDARD CONNECTIONS - NF

REFERENCE	DESCRIPTION	PAGE	REFERENCE	DESCRIPTION	PAGE
CX-MF	 METRIC MALE 24° CONE SEAT FRENCH GAZ TYPE <i>MASCHIO METRICO SVASATO 24°</i> <i>TIPO GAZ FRANCESE</i>	69	CX-FF45	 METRIC FEMALE 24° CONE 45° ELBOW - SLIP-ON NUT FRENCH GAZ TYPE <i>FEMMINA METRICA CONO 24°</i> <i>CURVA A 45° - DADO LIBERO</i> <i>TYPO GAZ FRANCESE</i>	70
CX-ETF	 STRAIGHT STANDPIPE FRENCH GAZ TYPE <i>ESTREMITA' TUBOLARE DIRITTA</i> <i>TIPO GAZ FRANCESE</i>	69	CX-FF90	 METRIC FEMALE 24° CONE 90° ELBOW - SLIP-ON NUT FRENCH GAZ TYPE <i>FEMMINA METRICA CONO 24°</i> <i>CURVA A 90° - DADO LIBERO</i> <i>TYPO GAZ FRANCESE</i>	70
CX-FF	 METRIC FEMALE 24° CONE SLIP-ON NUT - FRENCH GAZ TYPE <i>FEMMINA METRICA CONO 24°</i> <i>DADO LIBERO - TYPO GAZ FRANCESE</i>	69			

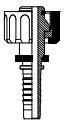
ACCESSORIES

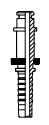
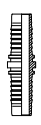
REFERENCE	DESCRIPTION	PAGE	REFERENCE	DESCRIPTION	PAGE
CX-FK	 WASHCLEANER METRIC FEMALE "FK" TYPE <i>FEMMINA METRICA PER IDROPULTRICI</i> <i>TIPO "FK"</i>	71	CP-T	 BRAZING STEM <i>CODOLO A SALDARE</i>	72
CX-IR	 PISTOL WASHCLEANER JUNCTION <i>ATTACCO PER PISTOLE IDROPULTRICI</i>	71	CP-CP	 DOUBLE STEM <i>DOPPIO CODOLO</i>	72

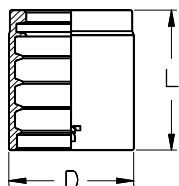
BXC

SWAGED NO-SKIVE FERRULE
BOCCOLA A PRESSARE SENZA PELATURA

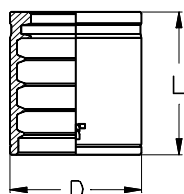
TIEFFE Part.N.	Hose Bore			Dimensions (mm)		Applications Applicazioni				
	DN	Inch	Size	D	L					
BXC04	6,3	1/4"	-04	19	23	1SC				
BXC05	8	5/16"	-05	20	27,5	1SC				
BXC06	10	3/8"	-06	23	30	1SC				
BXC08	12,5	1/2"	-08	26,5	32	1SC				
BXC10	16	5/8"	-10	29	35	1SC				
BXC12	19	3/4"	-12	33	34	1SC				
BXC16	25	1"	-16	42	45	1SC				

BXT1

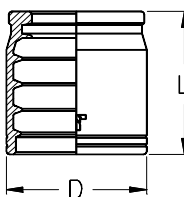
SWAGED NO-SKIVE FERRULE
BOCCOLA A PRESSARE SENZA PELATURA

TIEFFE Part.N.	Hose Bore			Dimensions (mm)		Applications Applicazioni				
	DN	Inch	Size	D	L					
BXT103	5	3/16"	-03	19	24	1SN	R1AT			
BXT104	6,3	1/4"	-04	20	27	1SN	R1AT	2SC	R16S	
BXT105	8	5/16"	-05	22	27,5	1SN	R1AT	2SC	R16S	
BXT106	10	3/8"	-06	24,5	30	1SN	R1AT	2SC	R16S	
BXT108	12,5	1/2"	-08	28	32,5	1SN	R1AT	2SC	R16S	
BXT110	16	5/8"	-10	32	35	1SN	R1AT	2SC	R16S	
BXT112	19	3/4"	-12	36	40	1SN	R1AT	2SC	R16S	
BXT116	25	1"	-16	45	50	1SN	R1AT	2SC	R16S	
BXT120	31,5	1 1/4"	-20	54	50	1SN	R1AT			
BXT124	38	1 1/2"	-24	62	55	1SN	R1AT			
BXT132	51	2"	-32	76	60	1SN	R1AT			

BXT2

SWAGED NO-SKIVE FERRULE
BOCCOLA A PRESSARE SENZA PELATURA

TIEFFE Part.N.	Hose Bore			Dimensions (mm)		Applications Applicazioni				
	DN	Inch	Size	D	L					
BXT203	5	3/16"	-03	20	24	2SN	R2AT			
BXT204	6,3	1/4"	-04	22	26	2SN	R2AT	1SN	R1AT	2SC R16S
BXT205	8	5/16"	-05	24	27,5	2SN	R2AT	1SN	R1AT	2SC R16S
BXT206	10	3/8"	-06	26	30	2SN	R2AT	1SN	R1AT	2SC R16S
BXT208	12,5	1/2"	-08	30	32,5	2SN	R2AT	1SN	R1AT	2SC R16S
BXT210	16	5/8"	-10	34	35	2SN	R2AT	1SN	R1AT	2SC R16S
BXT212	19	3/4"	-12	38	40	2SN	R2AT	1SN	R1AT	2SC R16S
BXT216	25	1"	-16	48	50	2SN	R2AT			
BXT220	31,5	1 1/4"	-20	60	57	2SN	R2AT			
BXT224	38	1 1/2"	-24	67	62	2SN	R2AT			
BXT232	51	2"	-32	80	66	2SN	R2AT			

 For **R16 - R17 - R19** and other compact braided hoses applications, contact **TIEFFE**.

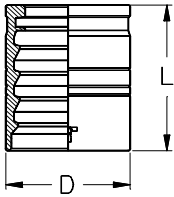
 Per applicazioni **R16 - R17 - R19** ed altri tubi trecciati compatti, contattare la **TIEFFE**.

BXLP

SWAGED SKIVE FERRULE
BOCCOLA A PRESSARE CON PELATURA

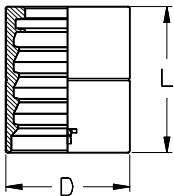
TIEFFE Part.N.	Hose Bore			Dimensions (mm)		Applications Applicazioni					
	DN	Inch	Size	D	L						
BXLP03	5	3/16"	-03	17	26	1SN	R1AT	2SN	R2AT		
BXLP04	6,3	1/4"	-04	19	29	1SN	R1AT	2SN	R2AT	2SC	R16S
BXLP05	8	5/16"	-05	21	29	1SN	R1AT	2SN	R2AT	2SC	R16S
BXLP06	10	3/8"	-06	23	31,5	1SN	R1AT	2SN	R2AT	2SC	R16S
BXLP08	12,5	1/2"	-08	27	34	1SN	R1AT	2SN	R2AT	2SC	R16S
BXLP10	16	5/8"	-10	32	37	1SN	R1AT	2SN	R2AT	2SC	R16S
BXLP12	19	3/4"	-12	36	43	1SN	R1AT	2SN	R2AT	2SC	R16S
BXLP16	25	1"	-16	44	49	1SN	R1AT	2SN	R2AT	2SC	R16S

BXL

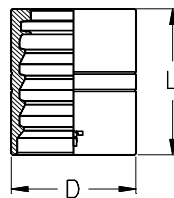
SWAGED SKIVE FERRULE
BOCCOLA A PRESSARE CON PELATURA

TIEFFE Part.N.	Hose Bore			Dimensions (mm)		Applications Applicazioni					
	DN	Inch	Size	D	L						
BXL20	31,5	1 1/4"	-20	50	55	1SN	R1AT				
BXL24	38	1 1/2"	-24	57	60	1SN	R1AT				
BXL32	51	2"	-32	70	75	1SN	R1AT				

BXP

SWAGED SKIVE FERRULE
BOCCOLA A PRESSARE CON PELATURA

TIEFFE Part.N.	Hose Bore			Dimensions (mm)		Applications Applicazioni					
	DN	Inch	Size	D	L						
BXP20	31,5	1 1/4"	-20	54	55	2SN	R2AT				
BXP24	38	1 1/2"	-24	62	60	2SN	R2AT				
BXP32	51	2"	-32	75	75	2SN	R2AT				

For R16 - R17 - R19 and other compact braided hoses applications, contact **TIEFFE**.

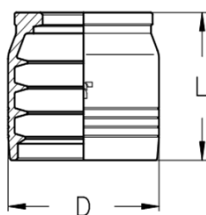
Per applicazioni R16 - R17 - R19 ed altri tubi trecciati compatti, contattare la **TIEFFE**.

BXT4

SWAGED NO-SKIVE FERRULE
BOCCOLA A PRESSARE SENZA PELATURA

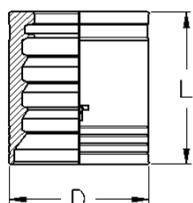
TIEFFE Part.N.	Hose Bore			Dimensions (mm)		Applications Applicazioni				
	DN	Inch	Size	D	L					
BXT412	19	3/4"	-12	43	41	4SP	4SH**	R12		
BXT416	25	1"	-16	51	52	4SP	4SH**	R12		

BXS

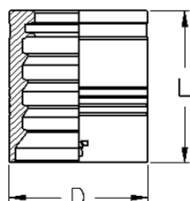
SWAGED SKIVE FERRULE
BOCCOLA A PRESSARE CON PELATURA

TIEFFE Part.N.	Hose Bore			Dimensions (mm)		Applications Applicazioni				
	DN	Inch	Size	D	L					
BXS04	6,3	1/4"	-04	22	30	4SP				
BXS06	10	3/8"	-06	26	32,5	4SP		R12	2ST	R2A
BXS08	12,5	1/2"	-08	30	35	4SP		R12	2ST	R2A
BXS10	16	5/8"	-10	34	38,5	4SP		R12	2ST	R2A
BXS12	19	3/4"	-12	38	43,5	4SP	4SH**	R12	2ST	R2A
BXS16	25	1"	-16	46	54	4SP	4SH**	R12	2ST	R2A
BXS20	31,5	1 1/4"	-20	56	61	4SP		R12	2ST	R2A
BXS24	38	1 1/2"	-24	65	68	4SP		R12	2ST	R2A
BXS32	51	2"	-32	78	74	4SP				

BXSH

SWAGED SKIVE FERRULE
BOCCOLA A PRESSARE CON PELATURA

TIEFFE Part.N.	Hose Bore			Dimensions (mm)		Applications Applicazioni				
	DN	Inch	Size	D	L					
BXSH20	31,5	1 1/4"	-20	54	61		4SH**			
BXSH24	38	1 1/2"	-24	62	69		4SH**			
BXSH32	51	2"	-32	76	74		4SH**	R12	2ST	R2A

** The application of "CX" series hose fittings must be limited to the "DIN856 4SP" maximum working pressure.

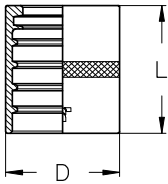
** L'applicazione dei raccordi per tubo flessibile serie "CX" deve essere limitata alla massima pressione di esercizio del tubo "EN856 4SP".

BX7

SWAGED NO-SKIVE FERRULE
BOCCOLA A PRESSARE SENZA PELATURA

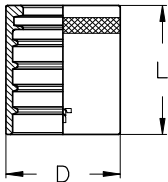
TIEFFE Part.N.	Hose Bore			Dimensions (mm)		Applications Applicazioni				
	DN	Inch	Size	D	L					
BX703	5	3/16"	-03	15	26		R7	R8		
BX704	6,3	1/4"	-04	17	29		R7	R8		
BX705	8	5/16"	-05	20	30,5	R6	R7	R8		
BX706	10	3/8"	-06	22	32	R6	R7	R8		
BX708	12,5	1/2"	-08	27	32,5	R6	R7	R8		
BX710	16	5/8"	-10	31	37	R6	R7	R8		
BX712	19	3/4"	-12	34,5	41	R6	R7	R8		
BX716	25	1"	-16	40	50	R6	R7			

BX8

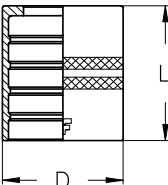
SWAGED NO-SKIVE FERRULE
BOCCOLA A PRESSARE SENZA PELATURA

TIEFFE Part.N.	Hose Bore			Dimensions (mm)		Applications Applicazioni				
	DN	Inch	Size	D	L					
BX816	25	1"	-16	43	52			R8		

BP3

SWAGED NO-SKIVE FERRULE
BOCCOLA A PRESSARE SENZA PELATURA

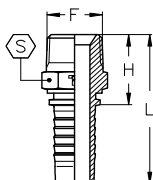
TIEFFE Part.N.	Hose Bore			Dimensions (mm)		Applications Applicazioni				
	DN	Inch	Size	D	L					
BP304	6,3	1/4"	-04	19	29	R3				
BP305	8	5/16"	-05	22	30	R3				
BP306	10	3/8"	-06	24	31	R3				
BP308	12,5	1/2"	-08	28,5	34	R3				
BP310	16	5/8"	-10	32	36	R3				
BP312	19	3/4"	-12	38	42	R3				
BP316	25	1"	-16	46	50	R3				
BP320	31,5	1 1/4"	-20	52	57	R3				

MGC
BSP TAPERED MALE 60° CONE SEAT
 MASCHIO GAS CONICO SVASATO 60°

AGR-K

TIEFFE Part.N.	Hose Size			BSP Connection Size		Dimensions (mm)						Maximum W.P.	
	DN	Inch	Dash	F	Dash	H	L	S				bar	PSI
CX0302MGC	5	3/16"	-03	1/8"-28	-02	20	45	12				350	5000
CX0304MGC	5	3/16"	-03	1/4"-19	-04	25	50	15				350	5000
CX0402MGC	6,3	1/4"	-04	1/8"-28	-02	21	49	12				350	5000
CX0404MGC	6,3	1/4"	-04	1/4"-19	-04	25	53	15				350	5000
CX0406MGC	6,3	1/4"	-04	3/8"-19	-06	26	54	19				280	4000
CX0504MGC	8	5/16"	-05	1/4"-19	-04	25	53	15				350	5000
CX0506MGC	8	5/16"	-05	3/8"-19	-06	26	54	19				280	4000
CX0604MGC	10	3/8"	-06	1/4"-19	-04	26	56	15				350	5000
CX0606MGC	10	3/8"	-06	3/8"-19	-06	27	57	19				280	4000
CX0608MGC	10	3/8"	-06	1/2"-14	-08	32	63	22				280	4000
CX0806MGC	12,5	1/2"	-08	3/8"-19	-06	28	64	19				280	4000
CX0808MGC	12,5	1/2"	-08	1/2"-14	-08	33	66	22				280	4000
CX1008MGC	16	5/8"	-10	1/2"-14	-08	33	69	22				280	4000
CX1012MGC	16	5/8"	-10	3/4"-14	-12	35	71	27				280	4000
CX1212MGC	19	3/4"	-12	3/4"-14	-12	36	77	27				280	4000
CX1216MGC	19	3/4"	-12	1"-11	-16	41	82	36				280	4000
CX1616MGC	25	1"	-16	1"-11	-16	43	94	36				280	4000
CX1620MGC	25	1"	-16	1 1/4"-11	-20	47	98	46				210	3000
CX2020MGC	31,5	1 1/4"	-20	1 1/4"-11	-20	48	106	46				210	3000
CX2424MGC	38	1 1/2"	-24	1 1/2"-11	-24	49	114	50				185	2700
CX3232MGC	51	2"	-32	2"-11	-32	57	127	65				175	2500

MG
BSP PARALLEL MALE 60° CONE SEAT
 MASCHIO GAS CILINDRICO SVASATO 60°

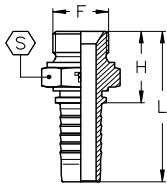
AGR

TIEFFE Part.N.	Hose Size			BSP Connection Size		Dimensions (mm)						Maximum W.P.	
	DN	Inch	Dash	F	Dash	H	L	S				bar	PSI
CX0302MG	5	3/16"	-03	1/8"-28	-02	20	45	14				350	5000
CX0304MG	5	3/16"	-03	1/4"-19	-04	24	49	19				415	6000
CX0402MG	6,3	1/4"	-04	1/8"-28	-02	20	48	14				350	5000
CX0404MG	6,3	1/4"	-04	1/4"-19	-04	25	53	19				450	6500
CX0406MG	6,3	1/4"	-04	3/8"-19	-06	27	55	22				450	6500
CX0408MG	6,3	1/4"	-04	1/2"-14	-08	32	60	27				415	6000
CX0504MG	8	5/16"	-05	1/4"-19	-04	25	53	19				350	5000
CX0506MG	8	5/16"	-05	3/8"-19	-06	27	55	22				350	5000
CX0508MG	8	5/16"	-05	1/2"-14	-08	32	60	27				350	5000
CX0604MG	10	3/8"	-06	1/4"-19	-04	25	55	19				445	6500
CX0606MG	10	3/8"	-06	3/8"-19	-06	27	58	22				445	6500
CX0608MG	10	3/8"	-06	1/2"-14	-08	32	62	27				415	6000
CX0806MG	12,5	1/2"	-08	3/8"-19	-06	28	61	22				415	6000
CX0808MG	12,5	1/2"	-08	1/2"-14	-08	33	66	27				415	6000
CX0810MG	12,5	1/2"	-08	5/8"-14	-10	35	68	30				350	5000
CX0812MG	12,5	1/2"	-08	3/4"-14	-12	36	69	32				350	5000
CX1008MG	16	5/8"	-10	1/2"-14	-08	33	69	27				350	5000
CX1010MG	16	5/8"	-10	5/8"-14	-10	35	71	30				350	5000
CX1012MG	16	5/8"	-10	3/4"-14	-12	36	72	32				350	5000
CX1208MG	19	3/4"	-12	1/2"-14	-08	34	74	27				350	5000
CX1210MG	19	3/4"	-12	5/8"-14	-10	36	76	30				350	5000
CX1212MG	19	3/4"	-12	3/4"-14	-12	37	77	32				350	5000
CX1216MG	19	3/4"	-12	1"-11	-16	42	82	41				280	4000
CX1612MG	25	1"	-16	3/4"-14	-12	38	89	32				280	4000
CX1616MG	25	1"	-16	1"-11	-16	43	94	41				280	4000
CX1620MG	25	1"	-16	1 1/4"-11	-20	46	97	50				250	3600
CX2020MG	31,5	1 1/4"	-20	1 1/4"-11	-20	47	105	50				210	3000
CX2024MG	31,5	1 1/4"	-20	1 1/2"-11	-24	50	108	55				210	3000
CX2424MG	38	1 1/2"	-24	1 1/2"-11	-24	50	115	55				185	2700
CX2432MG	38	1 1/2"	-24	2"-11	-32	55	119	70				185	2700
CX3232MG	51	2"	-32	2"-11	-32	56	126	70				175	2500

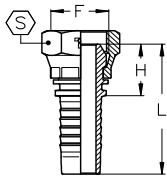
FGP
BSP FEMALE 60° CONE - CRIMPED-BACK NUT
FEMMINA GAS OGIVA 60° - DADO PRESSATO
DKR

TIEFFE Part.N.	Hose Size			BSP Connection Size		Dimensions (mm)					Maximum W.P.	
	DN	Inch	Dash	F	Dash	H	L	S			bar	PSI
CX0302FGP	5	3/16"	-03	1/8"-28	-02	16	41	14			350	5000
CX0304FGP	5	3/16"	-03	1/4"-19	-04	19	44	19			415	6000
CX0402FGP	6,3	1/4"	-04	1/8"-28	-02	17	45	14			350	5000
CX0404FGP	6,3	1/4"	-04	1/4"-19	-04	19	47	19			450	6500
CX0406FGP	6,3	1/4"	-04	3/8"-19	-06	22	50	22			450	6500
CX0408FGP	6,3	1/4"	-04	1/2"-14	-08	23	51	27			450	6500
CX0504FGP	8	5/16"	-05	1/4"-19	-04	19	47	19			350	5000
CX0506FGP	8	5/16"	-05	3/8"-19	-06	22	50	22			350	5000
CX0508FGP	8	5/16"	-05	1/2"-14	-08	23	51	27			350	5000
CX0604FGP	10	3/8"	-06	1/4"-19	-04	19	49	19			445	6500
CX0606FGP	10	3/8"	-06	3/8"-19	-06	21	51	22			445	6500
CX0608FGP	10	3/8"	-06	1/2"-14	-08	23	54	27			415	6000
CX0806FGP	12,5	1/2"	-08	3/8"-19	-06	22	56	22			415	6000
CX0808FGP	12,5	1/2"	-08	1/2"-14	-08	23	56	27			415	6000
CX0810FGP	12,5	1/2"	-08	5/8"-14	-10	24	57	30			350	5000
CX0812FGP	12,5	1/2"	-08	3/4"-14	-12	27	60	32			350	5000
CX1008FGP	16	5/8"	-10	1/2"-14	-08	23	59	27			350	5000
CX1010FGP	16	5/8"	-10	5/8"-14	-10	23	59	30			350	5000
CX1012FGP	16	5/8"	-10	3/4"-14	-12	27	63	32			350	5000
CX1208FGP	19	3/4"	-12	1/2"-14	-08	24	65	27			350	5000
CX1210FGP	19	3/4"	-12	5/8"-14	-10	24	64	30			350	5000
CX1212FGP	19	3/4"	-12	3/4"-14	-12	27	67	32			350	5000
CX1216FGP	19	3/4"	-12	1"-11	-16	30	70	41			280	4000
CX1612FGP	25	1"	-16	3/4"-14	-12	28	79	32			280	4000
CX1616FGP	25	1"	-16	1"-11	-16	30	81	41			280	4000
CX1620FGP	25	1"	-16	1 1/4"-11	-20	35	86	50			250	3600
CX2020FGP	31,5	1 1/4"	-20	1 1/4"-11	-20	34	92	50			210	3000
CX2024FGP	31,5	1 1/4"	-20	1 1/2"-11	-24	36	93	55			210	3000
CX2424FGP	38	1 1/2"	-24	1 1/2"-11	-24	34	99	55			185	2700
CX2432FGP	38	1 1/2"	-24	2"-11	-32	39	103	70			185	2700
CX3232FGP	51	2"	-32	2"-11	-32	37	107	70			175	2500

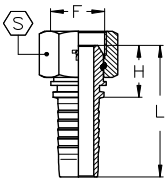
**FGL
FGS**
BSP FEMALE 60° CONE - FULL EXAGON NUT
FEMMINA GAS OGIVA 60° - DADO TUTTO ESAGONO
DKR

TIEFFE Part.N.	Hose Size			BSP Connection Size		Dimensions (mm)					Maximum W.P.	
	DN	Inch	Dash	F	Dash	H	L	S			bar	PSI
CX0404FGL	6,3	1/4"	-04	1/4"-19	-04	19	47	19			450	6500
CX0406FGL	6,3	1/4"	-04	3/8"-19	-06	19	47	22			450	6500
CX0506FGL	8	5/16"	-05	3/8"-19	-06	19	47	22			350	5000
CX0606FGL	10	3/8"	-06	3/8"-19	-06	19	50	22			445	6500
CX0608FGL	10	3/8"	-06	1/2"-14	-08	21	52	27			415	6000
CX0808FGL	12,5	1/2"	-08	1/2"-14	-08	22	55	27			415	6000
CX0810FGS	12,5	1/2"	-08	5/8"-14	-10	24	57	30			350	5000
CX1010FGS	16	5/8"	-10	5/8"-14	-10	23	59	30			350	5000
CX1012FGS	16	5/8"	-10	3/4"-14	-12	27	63	32			350	5000
CX1212FGS	20	3/4"	-12	3/4"-14	-12	27	67	32			350	5000
CX1216FGS	20	3/4"	-12	1"-11	-16	31	72	41			280	4000
CX1616FGS	25	1"	-16	1"-11	-16	31	82	41			280	4000

FGL - Slip-on nut (Dado libero)

FGS - Tieffe nut (Dado TIEFFE)

FGP45
BSP FEMALE 60° CONE - 45° ELBOW - CRIMPED-BACK NUT
 FEMMINA GAS OGIVA 60° - CURVA A 45° - DADO PRESSATO

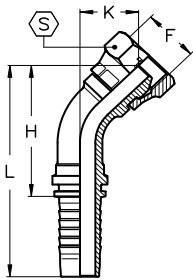
DKR45

TIEFFE Part.N.	Hose Size			BSP Connection Size		Dimensions (mm)					Maximum W.P.		
	DN	Inch	Dash	F	Dash	H	L	K	S		bar	PSI	
CX0302FGP45	5	3/16"	-03	1/8"-28	-02	33	58	14	14			350	5000
CX0304FGP45	5	3/16"	-03	1/4"-19	-04	35	60	16	19			415	6000
CX0402FGP45	6,3	1/4"	-04	1/8"-28	-02	36	64	16	14			350	5000
CX0404FGP45	6,3	1/4"	-04	1/4"-19	-04	37	65	16	19			450	6500
CX0406FGP45	6,3	1/4"	-04	3/8"-19	-06	40	68	19	22			450	6500
CX0408FGP45	6,3	1/4"	-04	1/2"-14	-08	42	70	21	27			450	6500
CX0504FGP45	8	5/16"	-05	1/4"-19	-04	39	67	18	19			350	5000
CX0506FGP45	8	5/16"	-05	3/8"-19	-06	41	69	19	22			350	5000
CX0508FGP45	8	5/16"	-05	1/2"-14	-08	43	71	21	27			350	5000
CX0604FGP45	10	3/8"	-06	1/4"-19	-04	41	72	18	19			445	6500
CX0606FGP45	10	3/8"	-06	3/8"-19	-06	42	73	19	22			445	6500
CX0608FGP45	10	3/8"	-06	1/2"-14	-08	44	75	21	27			415	6000
CX0806FGP45	12,5	1/2"	-08	3/8"-19	-06	49	82	22	22			415	6000
CX0808FGP45	12,5	1/2"	-08	1/2"-14	-08	49	82	22	27			415	6000
CX0810FGP45	12,5	1/2"	-08	5/8"-14	-10	49	82	22	30			350	5000
CX0812FGP45	12,5	1/2"	-08	3/4"-14	-12	53	86	26	32			350	5000
CX1008FGP45	16	5/8"	-10	1/2"-14	-08	57	93	26	27			350	5000
CX1010FGP45	16	5/8"	-10	5/8"-14	-10	54	90	24	30			350	5000
CX1012FGP45	16	5/8"	-10	3/4"-14	-12	57	93	26	32			350	5000
CX1208FGP45	19	3/4"	-12	1/2"-14	-08	68	108	30	27			350	5000
CX1210FGP45	19	3/4"	-12	5/8"-14	-10	66	106	28	30			350	5000
CX1212FGP45	19	3/4"	-12	3/4"-14	-12	66	106	28	32			350	5000
CX1216FGP45	19	3/4"	-12	1"-11	-16	68	108	30	41			280	4000
CX1612FGP45	25	1"	-16	3/4"-14	-12	87	138	38	32			280	4000
CX1616FGP45	25	1"	-16	1"-11	-16	84	135	36	41			280	4000
CX1620FGP45	25	1"	-16	1 1/4"-11	-20	85	136	37	50			250	3600
CX2020FGP45	31,5	1 1/4"	-20	1 1/4"-11	-20	100	157	43	50			210	3000
CX2024FGP45	31,5	1 1/4"	-20	1 1/2"-11	-24	100	157	43	55			210	3000
CX2424FGP45	38	1 1/2"	-24	1 1/2"-11	-24	116	180	49	55			185	2700
CX2432FGP45	38	1 1/2"	-24	2"-11	-32	116	180	49	70			185	2700
CX3232FGP45	51	2"	-32	2"-11	-32	157	227	69	70			175	2500

**FGL45
FGS45**
BSP FEMALE 60° CONE - 45° ELBOW - FULL EXAGON NUT
 FEMMINA GAS OGIVA 60° - CURVA A 45° - DADO TUTTO ESAGONO

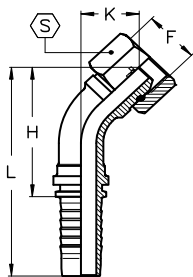
DKR45

TIEFFE Part.N.	Hose Size			BSP Connection Size		Dimensions (mm)					Maximum W.P.		
	DN	Inch	Dash	F	Dash	H	L	K	S		bar	PSI	
CX0404FGL45	6,3	1/4"	-04	1/4"-19	-04	35	63	13	19			450	6500
CX0406FGL45	6,3	1/4"	-04	3/8"-19	-06	36	64	14	22			450	6500
CX0506FGL45	8	5/16"	-05	3/8"-19	-06	37	65	14	22			350	5000
CX0606FGL45	10	3/8"	-06	3/8"-19	-06	38	68	14	22			445	6500
CX0608FGL45	10	3/8"	-06	1/2"-14	-08	41	71	17	27			415	6000
CX0808FGL45	12,5	1/2"	-08	1/2"-14	-08	44	77	18	27			415	6000
CX0810FGS45	12,5	1/2"	-08	5/8"-14	-10	49	82	23	30			350	5000
CX1010FGS45	16	5/8"	-10	5/8"-14	-10	54	90	23	30			350	5000
CX1012FGS45	16	5/8"	-10	3/4"-14	-12	57	93	26	32			350	5000
CX1212FGS45	19	3/4"	-12	3/4"-14	-12	66	106	29	32			350	5000
CX1216FGS45	19	3/4"	-12	1"-11	-16	68	109	31	41			280	4000
CX1616FGS45	25	1"	-16	1"-11	-16	84	135	36	41			280	4000

FGL - Slip-on nut (Dado libero)

FGS - Tieffe nut (Dado TIEFFE)

FGP90
BSP FEMALE 60° CONE - 90° ELBOW - CRIMPED-BACK NUT
 FEMMINA GAS OGIVA 60° - CURVA A 90° - DADO PRESSATO

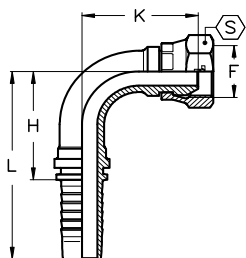
DKR90

TIEFFE Part.N.	Hose Size			BSP Connection Size		Dimensions (mm)					Maximum W.P.		
	DN	Inch	Dash	F	Dash	H	L	K	S		bar	PSI	
CX0302FGP90	5	3/16"	-03	1/8"-28	-02	21	46	23	14			350	5000
CX0304FGP90	5	3/16"	-03	1/4"-19	-04	21	46	26	19			415	6000
CX0402FGP90	6,3	1/4"	-04	1/8"-28	-02	26	54	28	14			350	5000
CX0404FGP90	6,3	1/4"	-04	1/4"-19	-04	26	54	28	19			450	6500
CX0406FGP90	6,3	1/4"	-04	3/8"-19	-06	26	54	32	22			450	6500
CX0408FGP90	6,3	1/4"	-04	1/2"-14	-08	26	54	36	27			450	6500
CX0504FGP90	8	5/16"	-05	1/4"-19	-04	28	56	31	19			350	5000
CX0506FGP90	8	5/16"	-05	3/8"-19	-06	28	56	34	22			350	5000
CX0508FGP90	8	5/16"	-05	1/2"-14	-08	28	56	37	27			350	5000
CX0604FGP90	10	3/8"	-06	1/4"-19	-04	31	61	34	19			445	6500
CX0606FGP90	10	3/8"	-06	3/8"-19	-06	31	61	35	22			445	6500
CX0608FGP90	10	3/8"	-06	1/2"-14	-08	31	61	38	27			415	6000
CX0806FGP90	12,5	1/2"	-08	3/8"-19	-06	37	70	42	22			415	6000
CX0808FGP90	12,5	1/2"	-08	1/2"-14	-08	37	70	42	27			415	6000
CX0810FGP90	12,5	1/2"	-08	5/8"-14	-10	37	70	43	30			350	5000
CX0812FGP90	12,5	1/2"	-08	3/4"-14	-12	37	70	48	32			350	5000
CX1008FGP90	16	5/8"	-10	1/2"-14	-08	45	80	50	27			350	5000
CX1010FGP90	16	5/8"	-10	5/8"-14	-10	45	80	46	30			350	5000
CX1012FGP90	16	5/8"	-10	3/4"-14	-12	45	80	50	32			350	5000
CX1208FGP90	19	3/4"	-12	1/2"-14	-08	54	95	59	27			350	5000
CX1210FGP90	19	3/4"	-12	5/8"-14	-10	54	95	56	30			350	5000
CX1212FGP90	19	3/4"	-12	3/4"-14	-12	54	95	56	32			350	5000
CX1216FGP90	19	3/4"	-12	1"-11	-16	54	95	59	41			280	4000
CX1612FGP90	25	1"	-16	3/4"-14	-12	70	121	75	32			280	4000
CX1616FGP90	25	1"	-16	1"-11	-16	70	121	72	41			280	4000
CX1620FGP90	25	1"	-16	1 1/4"-11	-20	70	121	73	50			250	3600
CX2020FGP90	31,5	1 1/4"	-20	1 1/4"-11	-20	84	142	87	50			210	3000
CX2024FGP90	31,5	1 1/4"	-20	1 1/2"-11	-24	84	142	87	55			210	3000
CX2424FGP90	38	1 1/2"	-24	1 1/2"-11	-24	100	165	100	55			185	2700
CX2432FGP90	38	1 1/2"	-24	2"-11	-32	100	165	100	70			185	2700
CX3232FGP90	51	2"	-32	2"-11	-32	134	204	141	70			175	2500

**FGL90
FGS90**
BSP FEMALE 60° CONE - 90° ELBOW - FULL EXAGON NUT
 FEMMINA GAS OGIVA 60° - CURVA A 90° - DADO TUTTO ESAGONO

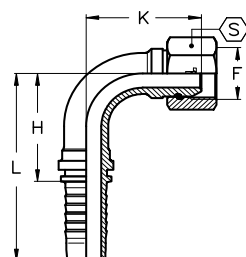
DKR90

TIEFFE Part.N.	Hose Size			BSP Connection Size		Dimensions (mm)					Maximum W.P.		
	DN	Inch	Dash	F	Dash	H	L	K	S		bar	PSI	
CX0404FGL90	6,3	1/4"	-04	1/4"-19	-04	29	57	26	19			450	6500
CX0406FGL90	6,3	1/4"	-04	3/8"-19	-06	29	57	28	22			450	6500
CX0506FGL90	8	5/16"	-05	3/8"-19	-06	29	57	28	22			350	5000
CX0606FGL90	10	3/8"	-06	3/8"-19	-06	30	61	29	22			445	6500
CX0608FGL90	10	3/8"	-06	1/2"-14	-08	30	61	32	27			415	6000
CX0808FGL90	12,5	1/2"	-08	1/2"-14	-08	37	70	35	27			415	6000
CX0810FGS90	12,5	1/2"	-08	5/8"-14	-10	37	70	43	30			350	5000
CX1010FGS90	16	5/8"	-10	5/8"-14	-10	44	80	46	30			350	5000
CX1012FGS90	16	5/8"	-10	3/4"-14	-12	44	80	50	32			350	5000
CX1212FGS90	19	3/4"	-12	3/4"-14	-12	54	94	56	32			350	5000
CX1216FGS90	19	3/4"	-12	1"-11	-16	54	94	60	41			280	4000
CX1616FGS90	25	1"	-16	1"-11	-16	70	121	72	41			280	4000

FGL - Slip-on nut (Dado libero)

FGS - Tieffe nut (Dado TIEFFE)

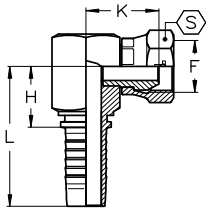
FGP90K
BSP FEMALE 60° CONE - 90° COMPACT ELBOW - CRIMPED-BACK NUT
FEMMINA GAS OGIVA 60° - CURVA COMPATTA 90° - DADO PRESSATO
DKR90
COMPACT

TIEFFE Part.N.	Hose Size			BSP Connection Size		Dimensions (mm)					Maximum W.P.	
	DN	Inch	Dash	F	Dash	H	L	K	S		bar	PSI
CX0404FGP90K	6,3	1/4"	-04	1/4"-19	-04	18	46	23	19		450	6500
CX0406FGP90K	6,3	1/4"	-04	3/8"-19	-06	21	49	26	22		450	6500
CX0506FGP90K	8	5/16"	-05	3/8"-19	-06	21	49	26	22		350	5000
CX0606FGP90K	10	3/8"	-06	3/8"-19	-06	21	52	26	22		445	6500
CX0608FGP90K	10	3/8"	-06	1/2"-14	-08	24	54	28	27		415	6000
CX0808FGP90K	12,5	1/2"	-08	1/2"-14	-08	24	57	28	27		415	6000
CX1212FGP90K	19	3/4"	-12	3/4"-14	-12	31	72	35	32		350	5000
CX1616FGP90K	25	1"	-16	1"-11	-16	38	89	41	41		280	4000

**FGOL
FGOS**
BSP FEMALE 60° O'RING CONE - FULL EXAGON NUT
 FEMMINA GAS OGIVA 60° O'RING - DADO TUTTO ESAGONO

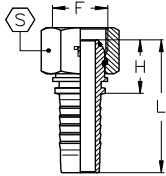
DKOR

TIEFFE Part.N.	Hose Size			BSP Connection Size		Dimensions (mm)					Maximum W.P.	
	DN	Inch	Dash	F	Dash	H	L	S	O-RING	bar	PSI	
CX0404FGOL	6,3	1/4"	-04	1/4"-19	-04	22	50	19	6,5x1	450	6500	
CX0406FGOL	6,3	1/4"	-04	3/8"-19	-06	24	52	22	8,5x1,5	450	6500	
CX0506FGOL	8	5/16"	-05	3/8"-19	-06	24	52	22	8,5x1,5	350	5000	
CX0606FGOL	10	3/8"	-06	3/8"-19	-06	24	54	22	8,5x1,5	445	6500	
CX0608FGOL	10	3/8"	-06	1/2"-14	-08	26	56	27	11,5x1,5	415	6000	
CX0808FGOL	12,5	1/2"	-08	1/2"-14	-08	26	59	27	11,5x1,5	415	6000	
CX0810FGOS	12,5	1/2"	-08	5/8"-14	-10	26	59	30	13x1,5	350	5000	
CX1010FGOS	16	5/8"	-10	5/8"-14	-10	25	61	30	13x1,5	350	5000	
CX1012FGOS	16	5/8"	-10	3/4"-14	-12	28	64	32	17x1,5	350	5000	
CX1212FGOS	19	3/4"	-12	3/4"-14	-12	28	68	32	17x1,5	350	5000	
CX1216FGOS	19	3/4"	-12	1"-11	-16	32	73	41	22x1,5	280	4000	
CX1616FGOS	25	1"	-16	1"-11	-16	32	83	41	22x1,5	280	4000	
CX1620FGOS	25	1"	-16	1 1/4"-11	-20	37	88	50	28,3x1,78	250	3600	
CX2020FGOS	31,5	1 1/4"	-20	1 1/4"-11	-20	36	94	50	28,3x1,78	210	3000	
CX2024FGOS	31,5	1 1/4"	-20	1 1/2"-11	-24	39	97	55	33,05x1,78	210	3000	
CX2424FGOS	38	1 1/2"	-24	1 1/2"-11	-24	38	102	55	33,05x1,78	185	2700	
CX2432FGOS	38	1 1/2"	-24	2"-11	-32	41	105	70	44,17x1,78	185	2700	
CX3232FGOS	51	2"	-32	2"-11	-32	40	110	70	44,17x1,78	175	2500	

 FGOL - Slip-on nut (*Dado libero*)

 FGOS - Tieffe nut (*Dado TIEFFE*)

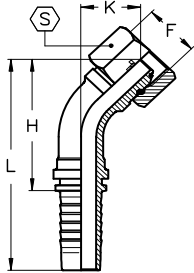
**FGOL45
FGOS45**
BSP FEMALE 60° O-RING CONE - 45° ELBOW - FULL EXAGON NUT
FEMMINA GAS OGIVA 60° O-RING - CURVA A 45° - DADO TUTTO ESAGONO
DKOR45

FGOL - Slip-on (Dado libero)

FGOS - Tieffe nut (Dado TIEFFE)

TIEFFE Part.N.	Hose Size			BSP Connection Size		Dimensions (mm)					Maximum W.P.	
	DN	Inch	Dash	F	Dash	H	L	K	S	O-RING	bar	PSI
CX0404FGOL45	6,3	1/4"	-04	1/4"-19	-04	35	63	13	19	6,5x1	450	6500
CX0406FGOL45	6,3	1/4"	-04	3/8"-19	-06	37	65	15	22	8,5x1,5	450	6500
CX0506FGOL45	8	5/16"	-05	3/8"-19	-06	38	66	15	22	8,5x1,5	350	5000
CX0606FGOL45	10	3/8"	-06	3/8"-19	-06	39	69	15	22	8,5x1,5	445	6500
CX0608FGOL45	10	3/8"	-06	1/2"-14	-08	41	71	18	27	11,5x1,5	415	6000
CX0808FGOL45	12,5	1/2"	-08	1/2"-14	-08	45	78	18	27	11,5x1,5	415	6000
CX0810FGOS45	12,5	1/2"	-08	5/8"-14	-10	51	84	24	30	13x1,5	350	5000
CX1010FGOS45	16	5/8"	-10	5/8"-14	-10	55	91	24	30	13x1,5	350	5000
CX1012FGOS45	16	5/8"	-10	3/4"-14	-12	58	94	27	32	17x1,5	350	5000
CX1212FGOS45	19	3/4"	-12	3/4"-14	-12	66	107	29	32	17x1,5	350	5000
CX1216FGOS45	19	3/4"	-12	1"-11	-16	69	110	32	41	22x1,5	280	4000
CX1616FGOS45	25	1"	-16	1"-11	-16	85	136	37	41	22x1,5	280	4000
CX1620FGOS45	25	1"	-16	1 1/4"-11	-20	85	136	37	50	28,3x1,78	250	3600
CX2020FGOS45	31,5	1 1/4"	-20	1 1/4"-11	-20	99	157	43	50	28,3x1,78	210	3000
CX2024FGOS45	31,5	1 1/4"	-20	1 1/2"-11	-24	99	157	43	55	33,05x1,78	210	3000
CX2424FGOS45	38	1 1/2"	-24	1 1/2"-11	-24	118	182	51	55	33,05x1,78	185	2700
CX2432FGOS45	38	1 1/2"	-24	2"-11	-32	120	190	53	70	44,17x1,78	185	2700
CX3232FGOS45	51	2"	-32	2"-11	-32	164	234	76	70	44,17x1,78	175	2500

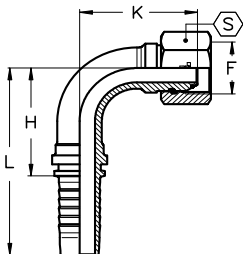
**FGOL90
FGOS90**
BSP FEMALE 60° O-RING CONE - 90° ELBOW - FULL EXAGON NUT
FEMMINA GAS OGIVA 60° O-RING - CURVA A 90° - DADO TUTTO ESAGONO
DKOR90

FGOL - Slip-on (Dado libero)

FGOS - Tieffe nut (Dado TIEFFE)

TIEFFE Part.N.	Hose Size			BSP Connection Size		Dimensions (mm)					Maximum W.P.	
	DN	Inch	Dash	F	Dash	H	L	K	S	O-RING	bar	PSI
CX0404FGOL90	6,3	1/4"	-04	1/4"-19	-04	29	57	27	19	6,5x1	450	6500
CX0406FGOL90	6,3	1/4"	-04	3/8"-19	-06	29	57	29	22	8,5x1,5	450	6500
CX0506FGOL90	8	5/16"	-05	3/8"-19	-06	29	57	29	22	8,5x1,5	350	5000
CX0606FGOL90	10	3/8"	-06	3/8"-19	-06	30	61	30	22	8,5x1,5	445	6500
CX0608FGOL90	10	3/8"	-06	1/2"-14	-08	30	61	33	27	11,5x1,5	415	6000
CX0808FGOL90	12,5	1/2"	-08	1/2"-14	-08	37	70	36	27	11,5x1,5	415	6000
CX0810FGOS90	12,5	1/2"	-08	5/8"-14	-10	37	70	45	30	13x1,5	350	5000
CX1010FGOS90	16	5/8"	-10	5/8"-14	-10	44	80	48	30	13x1,5	350	5000
CX1012FGOS90	16	5/8"	-10	3/4"-14	-12	44	80	51	32	17x1,5	350	5000
CX1212FGOS90	19	3/4"	-12	3/4"-14	-12	54	94	57	32	17x1,5	350	5000
CX1216FGOS90	19	3/4"	-12	1"-11	-16	54	94	61	41	22x1,5	280	4000
CX1616FGOS90	25	1"	-16	1"-11	-16	70	121	73	41	22x1,5	280	4000
CX1620FGOS90	25	1"	-16	1 1/4"-11	-20	70	121	75	50	28,3x1,78	250	3600
CX2020FGOS90	31,5	1 1/4"	-20	1 1/4"-11	-20	84	142	88	50	28,3x1,78	210	3000
CX2024FGOS90	31,5	1 1/4"	-20	1 1/2"-11	-24	84	142	88	55	33,05x1,78	210	3000
CX2424FGOS90	38	1 1/2"	-24	1 1/2"-11	-24	100	165	104	55	33,05x1,78	185	2700
CX2432FGOS90	38	1 1/2"	-24	2"-11	-32	100	165	107	70	44,17x1,78	185	2700
CX3232FGOS90	51	2"	-32	2"-11	-32	134	204	152	70	44,17x1,78	175	2500

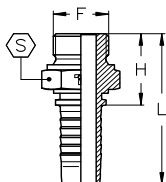
MGF
BSP PARALLEL MALE FLAT SEAT
MASCHIO GAS CILINDRICO SEDE PIANA
AGR
FLAT SEAT

TIEFFE Part.N.	Hose Size			BSP Connection Size		Dimensions (mm)					Maximum W.P.	
	DN	Inch	Dash	F	Dash	H	L	S			bar	PSI
CX0404MGF	6,3	1/4"	-04	1/4"-19	-04	25	53	19			450	6500
CX0406MGF	6,3	1/4"	-04	3/8"-19	-06	27	55	22			450	6500
CX0506MGF	8	5/16"	-05	3/8"-19	-06	27	55	22			350	5000
CX0606MGF	10	3/8"	-06	3/8"-19	-06	27	58	22			445	6500
CX0608MGF	10	3/8"	-06	1/2"-14	-08	32	62	27			415	6000
CX0808MGF	12,5	1/2"	-08	1/2"-14	-08	33	66	27			415	6000
CX0810MGF	12,5	1/2"	-08	5/8"-14	-10	35	68	30			350	5000
CX0812MGF	12,5	1/2"	-08	3/4"-14	-12	36	69	32			350	5000
CX1010MGF	16	5/8"	-10	5/8"-14	-10	35	71	30			350	5000
CX1012MGF	16	5/8"	-10	3/4"-14	-12	36	72	32			350	5000
CX1212MGF	19	3/4"	-12	3/4"-14	-12	37	77	32			350	5000
CX1216MGF	19	3/4"	-12	1"-11	-16	42	82	41			280	4000
CX1616MGF	25	1"	-16	1"-11	-16	43	94	41			280	4000
CX2020MGF	31,5	1 1/4"	-20	1 1/4"-11	-20	47	105	50			210	3000

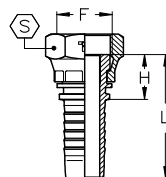
FGFP
BSP FEMALE FLAT SEAT - CRIMPED-BACK NUT
FEMMINA GAS SEDE PIANA - DADO PRESSATO
DKR
FLAT SEAT

TIEFFE Part.N.	Hose Size			BSP Connection Size		Dimensions (mm)					Maximum W.P.	
	DN	Inch	Dash	F	Dash	H	L	S			bar	PSI
CX0404FGFP	6,3	1/4"	-04	1/4"-19	-04	15	43	19			450	6500
CX0406FGFP	6,3	1/4"	-04	3/8"-19	-06	18	46	22			450	6500
CX0506FGFP	8	5/16"	-05	3/8"-19	-06	18	46	22			350	5000
CX0606FGFP	10	3/8"	-06	3/8"-19	-06	17	47	22			445	6500
CX0608FGFP	10	3/8"	-06	1/2"-14	-08	19	49	27			415	6000
CX0808FGFP	12,5	1/2"	-08	1/2"-14	-08	19	52	27			415	6000
CX0810FGFP	12,5	1/2"	-08	5/8"-14	-10	21	54	30			350	5000
CX0812FGFP	12,5	1/2"	-08	3/4"-14	-12	23	56	32			350	5000
CX1010FGFP	16	5/8"	-10	5/8"-14	-10	20	56	30			350	5000
CX1012FGFP	16	5/8"	-10	3/4"-14	-12	23	59	32			350	5000
CX1212FGFP	19	3/4"	-12	3/4"-14	-12	22	63	32			350	5000
CX1216FGFP	19	3/4"	-12	1"-11	-16	25	65	41			280	4000
CX1616FGFP	25	1"	-16	1"-11	-16	25	76	41			280	4000
CX2020FGFP	31,5	1 1/4"	-20	1 1/4"-11	-20	28	90	50			210	3000

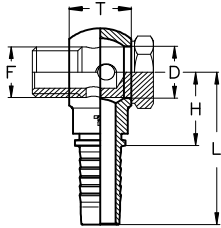
OG
BSP BANJO
OCCHIO BSP GAS **RNR**

TIEFFE Part.N.	Hose Bore			BSP BOLT Thread	Dimensions (mm)					Maximum W.P.	
	DN	Inch	Size		F	H	L	D	T	bar	PSI
CX0302OG	5	3/16"	-03	1/8"-28	20	45	10,2	10		280	4000
CX0304OG	5	3/16"	-03	1/4"-19	22,6	47,6	13,3	14		280	4000
CX0402OG	6,3	1/4"	-04	1/8"-28	23	51	10,2	10		280	4000
CX0404OG	6,3	1/4"	-04	1/4"-19	23	51	13,3	14		280	4000
CX0406OG	6,3	1/4"	-04	3/8"-19	26,5	54,5	16,8	17,5		280	4000
CX0408OG	6,3	1/4"	-04	1/2"-14	33,5	61,5	21	23		250	3600
CX0504OG	8	5/16"	-05	1/4"-19	24	52	13,3	14		280	4000
CX0506OG	8	5/16"	-05	3/8"-19	26,5	54,5	16,8	17,5		280	4000
CX0508OG	8	5/16"	-05	1/2"-14	33,5	61,5	21	23		250	3600
CX0604OG	10	3/8"	-06	1/4"-19	24	54,5	13,3	14		280	4000
CX0606OG	10	3/8"	-06	3/8"-19	24	54,5	16,8	17,5		280	4000
CX0608OG	10	3/8"	-06	1/2"-14	32	62,5	21	23		250	3600
CX0806OG	12,5	1/2"	-08	3/8"-19	26,5	59,5	16,8	17,5		280	4000
CX0808OG	12,5	1/2"	-08	1/2"-14	28,5	61,5	21	23		250	3600
CX0810OG	12,5	1/2"	-08	5/8"-14	31	64	23,1	23,5		210	3000
CX0812OG	12,5	1/2"	-08	3/4"-14	39	72	26,5	29,5		210	3000
CX1008OG	16	5/8"	-10	1/2"-14	27,2	63	21	23		250	3600
CX1010OG	16	5/8"	-10	5/8"-14	28,2	64	23,1	23,5		210	3000
CX1012OG	16	5/8"	-10	3/4"-14	34,7	70,5	26,5	29,5		210	3000
CX1212OG	19	3/4"	-12	3/4"-14	37,5	78	26,5	29,5		210	3000
CX1216OG	19	3/4"	-12	1"-11	39,5	90,5	33,5	37,5		165	2400
CX1616OG	25	1"	-16	1"-11	49	100	33,5	37,5		165	2400

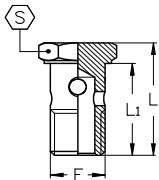
06VS
BSP BANJO BOLT
VITE FORATA GAS

TIEFFE Part.N.				BSP BOLT Thread	Dimensions (mm)						
					F	L	L1	S			
06VS02				1/8"-28	26	21,5	14				
06VS04				1/4"-19	34,3	29,5	19				
06VS06				3/8"-19	40,5	34	22				
06VS08				1/2"-14	46	36	27				
06VS10				5/8"-14	55	45,5	30				
06VS12				3/4"-14	56	48	32				
06VS16				1"-11	69	59	41				

MI
JIC MALE 37° CONE
 MASCHIO JIC CONO 37°

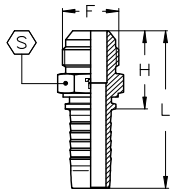
AGJ

TIEFFE Part.N.	Hose Size			JIC 37° Connection Size		Dimensions (mm)				Maximum W.P.	
	DN	Inch	Dash	F	Dash	H	L	S		bar	PSI
CX0304MI	5	3/16"	-03	7/16"-20	-04	25	50	12		415	6000
CX0305MI	5	3/16"	-03	1/2"-20	-05	25	50	14		415	6000
CX0404MI	6,3	1/4"	-04	7/16"-20	-04	25,5	53,5	12		400	5800
CX0405MI	6,3	1/4"	-04	1/2"-20	-05	25,5	53,5	14		400	5800
CX0406MI	6,3	1/4"	-04	9/16"-18	-06	26,6	54,6	15		350	5000
CX0505MI	8	5/16"	-05	1/2"-20	-05	25,5	53,5	14		350	5000
CX0506MI	8	5/16"	-05	9/16"-18	-06	26,6	54,6	15		350	5000
CX0508MI	8	5/16"	-05	3/4"-16	-08	29,7	57,7	19		350	5000
CX0606MI	10	3/8"	-06	9/16"-18	-06	26,6	57,1	15		350	5000
CX0608MI	10	3/8"	-06	3/4"-16	-08	29,7	60,2	19		350	5000
CX0610MI	10	3/8"	-06	7/8"-14	-10	34,3	64,8	24		350	5000
CX0808MI	12,5	1/2"	-08	3/4"-16	-08	30,7	63,7	19		350	5000
CX0810MI	12,5	1/2"	-08	7/8"-14	-10	35,3	68,3	24		350	5000
CX0812MI	12,5	1/2"	-08	1 1/16"-12	-12	38,9	71,9	27		350	5000
CX1010MI	16	5/8"	-10	7/8"-14	-10	35,5	71,3	24		350	5000
CX1012MI	16	5/8"	-10	1 1/16"-12	-12	39,1	74,9	27		350	5000
CX1210MI	19	3/4"	-12	7/8"-14	-10	37,3	77,8	27		350	5000
CX1212MI	19	3/4"	-12	1 1/16"-12	-12	39,9	80,4	27		350	5000
CX1214MI	19	3/4"	-12	1 3/16"-12	-14	41,6	82,1	32		280	4000
CX1216MI	19	3/4"	-12	1 5/16"-12	-16	42,1	82,6	34		280	4000
CX1612MI	25	1"	-16	1 1/16"-12	-12	41,9	92,9	32		280	4000
CX1616MI	25	1"	-16	1 5/16"-12	-16	43,6	94,6	34		280	4000
CX1620MI	25	1"	-16	1 5/8"-12	-20	46,8	97,8	42		280	4000
CX2020MI	31,5	1 1/4"	-20	1 5/8"-12	-20	47,6	105,3	42		210	3000
CX2024MI	31,5	1 1/4"	-20	1 7/8"-12	-24	52,8	110,5	50		185	2700
CX2424MI	38	1 1/2"	-24	1 7/8"-12	-24	53	117,5	50		185	2700
CX3232MI	51	2"	-32	2 1/2"-12	-32	63,4	133,4	65		175	2500

FIP
JIC FEMALE 37° CONE SEAT - CRIMPED-BACK NUT
 FEMMINA JIC SVASATA 37° - DADO PRESSATO

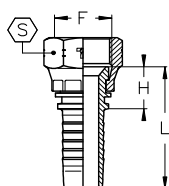
DKJ

TIEFFE Part.N.	Hose Size			JIC 37° Connection Size		Dimensions (mm)					Maximum W.P.	
	DN	Inch	Dash	F	Dash	H	L	S		bar	PSI	
CX0304FIP	5	3/16"	03	7/16"-20	-04	13,5	38,5	14			415	6000
CX0305FIP	5	3/16"	03	1/2"-20	-05	15	40	17			415	6000
CX0404FIP	6,3	1/4"	-04	7/16"-20	-04	14	42	14			400	5800
CX0405FIP	6,3	1/4"	-04	1/2"-20	-05	14,5	42,5	17			400	5800
CX0406FIP	6,3	1/4"	-04	9/16"-18	-06	16,5	44,5	19			350	5000
CX0505FIP	8	5/16"	-05	1/2"-20	-05	14,5	42,5	17			350	5000
CX0506FIP	8	5/16"	-05	9/16"-18	-06	15,5	43,5	19			350	5000
CX0508FIP	8	5/16"	-05	3/4"-16	-08	17,5	45,5	22			350	5000
CX0606FIP	10	3/8"	-06	9/16"-18	-06	15,5	46	19			350	5000
CX0608FIP	10	3/8"	-06	3/4"-16	-08	17,5	48	22			350	5000
CX0610FIP	10	3/8"	-06	7/8"-14	-10	18,5	48	27			350	5000
CX0808FIP	12,5	1/2"	-08	3/4"-16	-08	17,5	50,5	22			350	5000
CX0810FIP	12,5	1/2"	-08	7/8"-14	-10	18,5	51,5	27			350	5000
CX0812FIP	12,5	1/2"	-08	1 1/16"-12	-12	21,8	54,8	32			350	5000
CX1010FIP	16	5/8"	-10	7/8"-14	-10	18,7	54,5	27			350	5000
CX1012FIP	16	5/8"	-10	1 1/16"-12	-12	22	57,8	32			350	5000
CX1210FIP	19	3/4"	-12	7/8"-14	-10	19,5	60	27			350	5000
CX1212FIP	19	3/4"	-12	1 1/16"-12	-12	21,3	61,8	32			350	5000
CX1214FIP	19	3/4"	-12	1 3/16"-12	-14	25	65,5	36			280	4000
CX1216FIP-EX38	19	3/4"	-12	1 5/16"-12	-16	25,5	66	38			210	3000
CX1216FIP	19	3/4"	-12	1 5/16"-12	-16	25,5	66	41			280	4000
CX1612FIP	25	1"	-16	1 1/16"-12	-12	22,8	73,8	32			280	4000
CX1616FIP-EX38	25	1"	-16	1 5/16"-12	-16	25,5	76,5	38			210	3000
CX1616FIP	25	1"	-16	1 5/16"-12	-16	25,5	76,5	41			280	4000
CX1620FIP	25	1"	-16	1 5/8"-12	-20	28,5	79,5	50			210	3000
CX2020FIP	31,5	1 1/4"	-20	1 5/8"-12	-20	27,8	85,5	50			210	3000
CX2024FIP-EX55	31,5	1 1/4"	-20	1 7/8"-12	-24	31,3	89	55			140	2000
CX2024FIP	31,5	1 1/4"	-20	1 7/8"-12	-24	31,3	89	60			185	2700
CX2424FIP-EX55	38	1 1/2"	-24	1 7/8"-12	-24	30	94,5	55			140	2000
CX2424FIP	38	1 1/2"	-24	1 7/8"-12	-24	30	94,5	60			185	2700
CX3232FIP-EX70	51	2"	-32	2 1/2"-12	-32	34	104	70			105	1500
CX3232FIP	51	2"	-32	2 1/2"-12	-32	34	104	75			175	2500

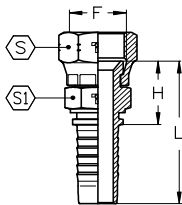
FICP
JIC FEMALE 37° CONE SEAT - DOUBLE EXAGON - CRIMPED-BACK NUT
FEMMINA JIC SVASATA 37° - DOPPIO ESAGONO - DADO PRESSATO
DKJ

TIEFFE Part.N.	Hose Size			JIC 37° Connection Size		Dimensions (mm)				Maximum W.P.	
	DN	Inch	Dash	F	Dash	H	L	S	S1	bar	PSI
CX0304FICP	5	3/16"	-03	7/16"-20	-04	19	44	14	12	415	6000
CX0404FICP	6,3	1/4"	-04	7/16"-20	-04	20,5	48,5	14	14	415	6000
CX0405FICP	6,3	1/4"	-04	1/2"-20	-05	21	49	17	14	400	5800
CX0406FICP	6,3	1/4"	-04	9/16"-18	-06	22	50	19	14	350	5000
CX0505FICP	8	5/16"	-05	1/2"-20	-05	21	49	17	14	350	5000
CX0506FICP	8	5/16"	-05	9/16"-18	-06	22,5	50,5	19	16	350	5000
CX0604FICP	10	3/8"	-06	7/16"-20	-04	21	51,5	14	16	350	5000
CX0605FICP	10	3/8"	-06	1/2"-20	-05	21,5	52	17	16	350	5000
CX0606FICP	10	3/8"	-06	9/16"-18	-06	22,5	53	19	16	350	5000
CX0608FICP	10	3/8"	-06	3/4"-16	-08	24,5	55	22	19	350	5000
CX0610FICP	10	3/8"	-06	7/8"-14	-10	36,5	57	27	22	350	5000
CX0806FICP	12,5	1/2"	-08	9/16"-18	-06	24,5	57,5	19	19	350	5000
CX0808FICP	12,5	1/2"	-08	3/4"-16	-08	25,5	58,5	22	19	350	5000
CX0810FICP	12,5	1/2"	-08	7/8"-14	-10	27,5	60,5	27	22	350	5000
CX0812FICP	12,5	1/2"	-08	1 1/16"-12	-12	30,3	63,3	32	25	350	5000
CX1008FICP	16	5/8"	-10	3/4"-16	-08	26,7	62,5	22	22	350	5000
CX1010FICP	16	5/8"	-10	7/8"-14	-10	27,7	63,5	27	22	350	5000
CX1012FICP	16	5/8"	-10	1 1/16"-12	-12	30,5	66,3	32	25	350	5000
CX1210FICP	19	3/4"	-12	7/8"-14	-10	30	70,5	27	27	350	5000
CX1212FICP	19	3/4"	-12	1 1/16"-12	-12	31,8	72,3	32	27	350	5000
CX1214FICP	19	3/4"	-12	1 3/16"-12	-14	34,5	75	36	30	280	4000
CX1216FICP-EX38	19	3/4"	-12	1 5/16"-12	-16	35,5	76	38	32	210	3000
CX1216FICP	19	3/4"	-12	1 5/16"-12	-16	35,5	76	41	32	280	4000
CX1612FICP	25	1"	-16	1 1/16"-12	-12	34,3	85,3	32	32	280	4000
CX1616FICP-EX38	25	1"	-16	1 5/16"-12	-16	37	88	38	32	210	3000
CX1616FICP	25	1"	-16	1 5/16"-12	-16	37	88	41	32	280	4000
CX1620FICP	25	1"	-16	1 5/8"-12	-20	42	93	50	41	210	3000
CX2020FICP	31,5	1 1/4"	-20	1 5/8"-12	-20	42,8	100,5	50	41	210	3000
CX2424FICP-EX55	38	1 1/2"	-24	1 7/8"-12	-24	47	111,5	55	46	140	2000
CX2424FICP	38	1 1/2"	-24	1 7/8"-12	-24	47	111,5	60	46	185	2700
CX3232FICP-EX70	51	2"	-32	2 1/2"-12	-32	55,5	125,5	70	60	105	1500
CX3232FICP	51	2"	-32	2 1/2"-12	-32	55,5	125,5	75	60	175	2500

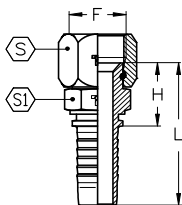
FICS
JIC FEMALE 37° CONE SEAT - DOUBLE EXAGON - TIEFFE NUT
FEMMINA JIC SVASATA 37° - DOPPIO ESAGONO - DADO TIEFFE
DKJ

TIEFFE Part.N.	Hose Size			JIC 37° Connection Size		Dimensions (mm)				Maximum W.P.	
	DN	Inch	Dash	F	Dash	H	L	S	S1	bar	PSI
CX0810FICS	12,5	1/2"	-08	7/8"-14	-10	29	62	27	22	350	5000
CX1010FICS	16	5/8"	-10	7/8"-14	-10	29,2	65	27	22	350	5000
CX1012FICS	16	5/8"	-10	1 1/16"-12	-12	31,4	67,2	32	25	350	5000
CX1212FICS	19	3/4"	-12	1 1/16"-12	-12	32,7	73,2	32	27	350	5000
CX1214FICS	19	3/4"	-12	1 3/16"-12	-14	34,7	75,2	36	30	280	4000
CX1216FICS	19	3/4"	-12	1 5/16"-12	-16	36,5	77	41	32	280	4000
CX1616FICS	25	1"	-16	1 5/16"-12	-16	38	89	41	32	280	4000
CX1620FICS	25	1"	-16	1 5/8"-12	-20	44	95	50	41	280	4000
CX2020FICS	31,5	1 1/4"	-20	1 5/8"-12	-20	44,8	102,5	50	41	210	3000
CX2424FICS	38	1 1/2"	-24	1 7/8"-12	-24	48	112,5	60	46	185	2700
CX3232FICS	51	2"	-32	2 1/2"-12	-32	59,5	129,5	75	60	175	2500

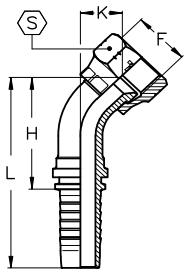
FIP45
JIC FEMALE 37° CONE SEAT - 45° ELBOW - CRIMPED-BACK NUT
FEMMINA JIC SVASATA 37° - CURVA A 45° - DADO PRESSATO
DKJ45

TIEFFE Part.N.	Hose Size			JIC 37° Connection Size		Dimensions (mm)				Maximum W.P.	
	DN	Inch	Dash	F	Dash	H	L	K	S	bar	PSI
CX0304FIP45	5	3/16"	03	7/16"-20	-04	29	54	10	14	415	6000
CX0305FIP45	5	3/16"	03	1/2"-20	-05	30	55	11	17	415	6000
CX0404FIP45	6,3	1/4"	-04	7/16"-20	-04	31	59	10	14	400	5800
CX0405FIP45	6,3	1/4"	-04	1/2"-20	-05	32	60	11	17	400	5800
CX0406FIP45	6,3	1/4"	-04	9/16"-18	-06	33	61	12	19	350	5000
CX0505FIP45	8	5/16"	-05	1/2"-20	-05	33	61	11	17	350	5000
CX0506FIP45	8	5/16"	-05	9/16"-18	-06	34	62	12	19	350	5000
CX0508FIP45	8	5/16"	-05	3/4"-16	-08	36	64	14	22	350	5000
CX0606FIP45	10	3/8"	-06	9/16"-18	-06	35,5	66	12	19	350	5000
CX0608FIP45	10	3/8"	-06	3/4"-16	-08	37,5	68	14	22	350	5000
CX0610FIP45	10	3/8"	-06	7/8"-14	-10	39,5	70	16	27	350	5000
CX0808FIP45	12,5	1/2"	-08	3/4"-16	-08	41	37	14,5	22	350	5000
CX0810FIP45	12,5	1/2"	-08	7/8"-14	-10	43	76	16	27	350	5000
CX0812FIP45	12,5	1/2"	-08	1 1/16"-12	-12	45,5	78,5	19	32	350	5000
CX1010FIP45	16	5/8"	-10	7/8"-14	-10	47	83	16	27	350	5000
CX1012FIP45	16	5/8"	-10	1 1/16"-12	-12	50	86	19	32	350	5000
CX1210FIP45	19	3/4"	-12	7/8"-14	-10	64	105	27	27	350	5000
CX1212FIP45	19	3/4"	-12	1 1/16"-12	-12	59	99	22	32	350	5000
CX1214FIP45	19	3/4"	-12	1 3/16"-12	-14	59	100	22	36	280	4000
CX1216FIP45-EX38	19	3/4"	-12	1 5/16"-12	-16	61	101	24	38	210	3000
CX1216FIP45	19	3/4"	-12	1 5/16"-12	-16	61	101	24	41	280	4000
CX1612FIP45	25	1"	-16	1 1/16"-12	-12	83	134	35	32	280	4000
CX1616FIP45-EX38	25	1"	-16	1 5/16"-12	-16	72	123	24	38	210	3000
CX1616FIP45	25	1"	-16	1 5/16"-12	-16	72	123	24	41	280	4000
CX1620FIP45	25	1"	-16	1 5/8"-12	-20	76	127	28	50	210	3000
CX2020FIP45	31,5	1 1/4"	-20	1 5/8"-12	-20	95	153	38	50	210	3000
CX2024FIP45-EX55	31,5	1 1/4"	-20	1 7/8"-12	-24	88	144	32	55	140	2000
CX2024FIP45	31,5	1 1/4"	-20	1 7/8"-12	-24	88	144	32	60	185	2700
CX2424FIP45-EX55	38	1 1/2"	-24	1 7/8"-12	-24	113	178	46	55	140	2000
CX2424FIP45	38	1 1/2"	-24	1 7/8"-12	-24	113	178	46	60	185	2700
CX3232FIP45-EX70	51	2"	-32	2 1/2"-12	-32	150	220	61	70	105	1500
CX3232FIP45	51	2"	-32	2 1/2"-12	-32	150	220	61	75	175	2500

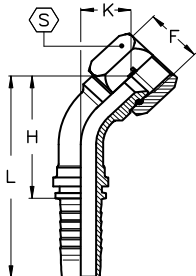
FIS45
JIC FEMALE 37° CONE SEAT - 45° ELBOW - TIEFFE NUT
FEMMINA JIC SVASATA 37° - CURVA A 45° - DADO TIEFFE
DKJ45

TIEFFE Part.N.	Hose Size			JIC 37° Connection Size		Dimensions (mm)				Maximum W.P.	
	DN	Inch	Dash	F	Dash	H	L	K	S	bar	PSI
CX0810FIS45	12,5	1/2"	-08	7/8"-14	-10	47,5	80,5	21	27	350	5000
CX1010FIS45	16	5/8"	-10	7/8"-14	-10	53	89	22,5	27	350	5000
CX1012FIS45	16	5/8"	-10	1 1/16"-12	-12	54,5	90,5	23,5	32	350	5000
CX1212FIS45	19	3/4"	-12	1 1/16"-12	-12	63	104	26	32	350	5000
CX1214FIS45	19	3/4"	-12	1 3/16"-12	-14	64	105	27	36	280	4000
CX1216FIS45	19	3/4"	-12	1 5/16"-12	-16	65	106	28	41	280	4000
CX1616FIS45	25	1"	-16	1 5/16"-12	-16	83	134	34	41	280	4000
CX1620FIS45	25	1"	-16	1 5/8"-12	-20	83	134	34	50	280	4000
CX2020FIS45	31,5	1 1/4"	-20	1 5/8"-12	-20	96	154	39	50	210	3000
CX2424FIS45	38	1 1/2"	-24	1 7/8"-12	-24	113	178	46	60	185	2700
CX3232FIS45	51	2"	-32	2 1/2"-12	-32	152	222	63	75	175	2500

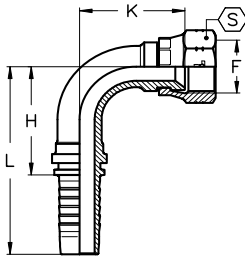
FIP90
JIC FEMALE 37° CONE SEAT - 90° ELBOW - CRIMPED-BACK NUT
FEMMINA JIC SVASATA 37° - CURVA A 90° - DADO PRESSATO
DKJ90

TIEFFE Part.N.	Hose Size			JIC 37° Connection Size		Dimensions (mm)				Maximum W.P.	
	DN	Inch	Dash	F	Dash	H	L	K	S	bar	PSI
CX0304FIP90	5	3/16"	-03	7/16"-20	-04	21	46	21	14	415	6000
CX0404FIP90	6,3	1/4"	-04	7/16"-20	-04	25,5	53,5	26	14	415	6000
CX0405FIP90	6,3	1/4"	-04	1/2"-20	-05	25,5	53,5	26	17	400	5800
CX0406FIP90	6,3	1/4"	-04	9/16"-18	-06	25,5	53,5	27	19	350	5000
CX0505FIP90	8	5/16"	-05	1/2"-20	-05	28	56	29	17	350	5000
CX0506FIP90	8	5/16"	-05	9/16"-18	-06	28	56	29	19	350	5000
CX0606FIP90	10	3/8"	-06	9/16"-18	-06	31	61,5	33	19	350	5000
CX0608FIP90	10	3/8"	-06	3/4"-16	-08	31	61,5	33	22	350	5000
CX0808FIP90	12,5	1/2"	-08	3/4"-16	-08	37	70	39	22	350	5000
CX0810FIP90	12,5	1/2"	-08	7/8"-14	-10	37	70	40	27	350	5000
CX1010FIP90	16	5/8"	-10	7/8"-14	-10	45	81	45	27	350	5000
CX1012FIP90	16	5/8"	-10	1 1/16"-12	-12	45	81	47	32	350	5000
CX1210FIP90	19	3/4"	-12	7/8"-14	-10	55	95	54	27	350	5000
CX1212FIP90	19	3/4"	-12	1 1/16"-12	-12	55	95	53	32	350	5000
CX1214FIP90	19	3/4"	-12	1 3/16"-12	-14	55	95	54	36	280	4000
CX1216FIP90-EX38	19	3/4"	-12	1 5/16"-12	-16	55	95	56	38	210	3000
CX1216FIP90	19	3/4"	-12	1 5/16"-12	-16	55	95	56	41	280	4000
CX1612FIP90	25	1"	-16	1 1/16"-12	-12	71	122	71	32	280	4000
CX1616FIP90-EX38	25	1"	-16	1 5/16"-12	-16	71	122	70	38	210	3000
CX1616FIP90	25	1"	-16	1 5/16"-12	-16	71	122	70	41	280	4000
CX1620FIP90	25	1"	-16	1 5/8"-12	-20	71	122	70	50	210	3000
CX2020FIP90	31,5	1 1/4"	-20	1 5/8"-12	-20	86	143	82	50	210	3000
CX2024FIP90-EX55	31,5	1 1/4"	-20	1 7/8"-12	-24	86	143	82	55	140	2000
CX2024FIP90	31,5	1 1/4"	-20	1 7/8"-12	-24	86	143	82	60	185	2700
CX2424FIP90-EX55	38	1 1/2"	-24	1 7/8"-12	-24	102	167	96	55	140	2000
CX2424FIP90	38	1 1/2"	-24	1 7/8"-12	-24	102	167	96	60	185	2700
CX3232FIP90-EX70	51	2"	-32	2 1/2"-12	-32	137	207	134	70	105	1500
CX3232FIP90	51	2"	-32	2 1/2"-12	-32	137	207	134	75	175	2500

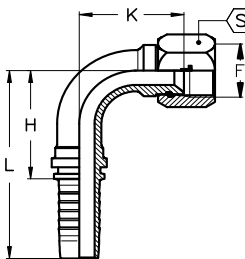
FIS90
JIC FEMALE 37° CONE SEAT - 90° ELBOW - TIEFFE NUT
FEMMINA JIC SVASATA 37° - CURVA A 90° - DADO TIEFFE
DKJ90

TIEFFE Part.N.	Hose Size			JIC 37° Connection Size		Dimensions (mm)				Maximum W.P.	
	DN	Inch	Dash	F	Dash	H	L	K	S	bar	PSI
CX0810FIS90	12,5	1/2"	-08	7/8"-14	-10	37	70	40	27	350	5000
CX1010FIS90	16	5/8"	-10	7/8"-14	-10	45	81	45	27	350	5000
CX1012FIS90	16	5/8"	-10	1 1/16"-12	-12	45	81	47	32	350	5000
CX1212FIS90	19	3/4"	-12	1 1/16"-12	-12	55	95	53	32	350	5000
CX1214FIS90	19	3/4"	-12	1 3/16"-12	-14	55	95	54	36	280	4000
CX1216FIS90	19	3/4"	-12	1 5/16"-12	-16	55	95	56	41	280	4000
CX1616FIS90	25	1"	-16	1 5/16"-12	-16	71	122	70	41	280	4000
CX1620FIS90	25	1"	-16	1 5/8"-12	-20	71	122	70	50	280	4000
CX2020FIS90	31,5	1 1/4"	-20	1 5/8"-12	-20	86	143	82	50	210	3000
CX2424FIS90	38	1 1/2"	-24	1 7/8"-12	-24	102	167	96	60	185	2700
CX3232FIS90	51	2"	-32	2 1/2"-12	-32	137	207	134	75	175	2500

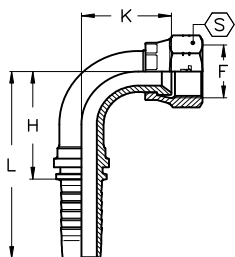
FIP90C
JIC FEMALE 37° CONE SEAT - 90° ELBOW - SHORT DROP - CRIMPED-BACK NUT
FEMMINA JIC SVASATA 37° - CURVA A 90° CORTA - DADO PRESSATO
DKJ90
 SHORT DROP

TIEFFE Part.N.	Hose Size			JIC 37° Connection Size		Dimensions (mm)					Maximum W.P.	
	DN	Inch	Dash	F	Dash	H	L	K	S	bar	PSI	
CX0304FIP90C	5	3/16"	-03	7/16"-20	-04	21	46	18	14		415	6000
CX0305FIP90C	5	3-16"	-03	1/2"-20	-05	21	46	19	17		415	6000
CX0404FIP90C	6,3	1/4"	-04	7/16"-20	-04	25,5	53,5	20	14		400	5800
CX0405FIP90C	6,3	1/4"	-04	1/2"-20	-05	25,5	53,5	21	17		400	5800
CX0406FIP90C	6,3	1/4"	-04	9/16"-18	-06	25,5	53,5	23	19		350	5000
CX0505FIP90C	8	5/16"	-05	1/2"-20	-05	28	56	22	17		350	5000
CX0506FIP90C	8	5/16"	-05	9/16"-18	-06	28	56	24	19		350	5000
CX0508FIP90C	8	5/16"	-05	3/4"-16	-08	28	56	27	22		350	5000
CX0606FIP90C	10	3/8"	-06	9/16"-18	-06	30	60,5	23	19		350	5000
CX0608FIP90C	10	3/8"	-06	3/4"-16	-08	31	61,5	29	22		350	5000
CX0610FIP90C	10	3/8"	-06	7/8"-14	-10	31	61,5	31	27		350	5000
CX0808FIP90C	12,5	1/2"	-08	3/4"-16	-12	37	70	29	22		350	5000
CX0810FIP90C	12,5	1/2"	-08	7/8"-14	-10	38	71	33	27		350	5000
CX0812FIP90C	12,5	1/2"	-08	1 1/16"-12	-12	40	73	40	32		350	5000
CX1010FIP90C	16	5/8"	-10	7/8"-14	-10	43	79	33	27		350	5000
CX1012FIP90C	16	5/8"	-10	1 1/16"-12	-12	45	81	40	32		350	5000
CX1212FIP90C	19	3/4"	-12	1 1/16"-12	-12	55	95	43	32		350	5000
CX1214FIP90C	19	3/4"	-12	1 3/16"-12	-14	55	95	47	36		280	4000
CX1216FIP90C-EX38	19	3/4"	-12	1 5/16"-12	-16	55	95	49	38		210	3000
CX1216FIP90C	19	3/4"	-12	1 5/16"-12	-16	55	95	49	41		280	4000
CX1616FIP90C-EX38	25	1"	-16	1 5/16"-12	-16	71	122	56	38		210	3000
CX1616FIP90C	25	1"	-16	1 5/16"-12	-16	71	122	56	41		280	4000
CX1620FIP90C	25	1"	-16	1 5/8"-12	-20	71	122	61	50		210	3000

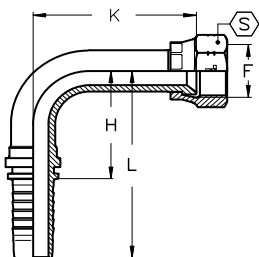
FIP90L
JIC FEMALE 37° CONE SEAT - 90° ELBOW - LONG DROP - CRIMPED-BACK NUT
FEMMINA JIC SVASATA 37° - CURVA A 90° LUNGA - DADO PRESSATO
DKJ90
 LONG DROP

TIEFFE Part.N.	Hose Size			JIC 37° Connection Size		Dimensions (mm)					Maximum W.P.	
	DN	Inch	Dash	F	Dash	H	L	K	S	bar	PSI	
CX0304FIP90L	5	3/16"	-03	7/16"-20	-04	21	46	46	14		415	6000
CX0404FIP90L	6,3	1/4"	-04	7/16"-20	-04	25,5	53,5	46	14		400	5800
CX0405FIP90L	6,3	1/4"	-04	1/2"-20	-05	25,5	53,5	46	17		400	5800
CX0406FIP90L	6,3	1/4"	-04	9/16"-18	-06	25,5	53,5	54	19		350	5000
CX0505FIP90L	8	5/16"	-05	1/2"-20	-05	28	56	46	17		350	5000
CX0506FIP90L	8	5/16"	-05	9/16"-18	-06	28	56	54	19		350	5000
CX0606FIP90L	10	3/8"	-06	9/16"-18	-06	31	61,5	54	19		350	5000
CX0608FIP90L	10	3/8"	-06	3/4"-16	-08	31	61,5	64	22		350	5000
CX0808FIP90L	12,5	1/2"	-08	3/4"-16	-08	38	71	64	22		350	5000
CX0810FIP90L	12,5	1/2"	-08	7/8"-14	-10	38	71	70	27		350	5000
CX1010FIP90L	16	5/8"	-10	7/8"-14	-10	45	81	70	27		350	5000
CX1012FIP90L	16	5/8"	-10	1 1/16"-12	-12	45	81	96	32		350	5000
CX1212FIP90L	19	3/4"	-12	1 1/16"-12	-12	55	95	96	32		350	5000
CX1214FIP90L	19	3/4"	-12	1 3/16"-12	-14	55	95	96	36		280	4000
CX1216FIP90L-EX38	19	3/4"	-12	1 5/16"-12	-16	55	95	114	38		210	3000
CX1216FIP90L	19	3/4"	-12	1 5/16"-12	-16	55	95	114	41		280	4000
CX1616FIP90L-EX38	25	1"	-16	1 5/16"-12	-16	71	122	114	38		210	3000
CX1616FIP90L	25	1"	-16	1 5/16"-12	-16	71	122	114	41		280	4000

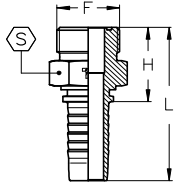
MRS
**ORFS MALE
MASCHIO ORFS**
AG ORFS

TIEFFE Part.N.	Hose Size			ORFS Connection Size		Dimensions (mm)					Maximum W.P.	
	DN	Inch	Dash	F	Dash	H	L	S	O-RING	bar	PSI	
CX0404MRS	6,3	1/4"	-04	9/16"-18	-04	23,5	51,5	17	7,65x1,78	450	6500	
CX0406MRS	6,3	1/4"	-04	11/16"-16	-06	25,5	53,5	19	9,25x1,78	450	6500	
CX0506MRS	8	5/16"	-05	11/16"-16	-06	25,5	53,5	19	9,25x1,78	350	5000	
CX0606MRS	10	3/8"	-06	11/16"-16	-06	25,5	56	19	9,25x1,78	450	6500	
CX0608MRS	10	3/8"	-06	13/16"-16	-08	28,5	59	22	12,42x1,78	450	6500	
CX0610MRS	10	3/8"	-06	1"-14	-10	33	63,5	27	15,6x1,78	450	6500	
CX0808MRS	12,5	1/2"	-08	13/16"-16	-08	29,5	62,5	22	12,42x1,78	415	6000	
CX0810MRS	12,5	1/2"	-08	1"-14	-10	34	67	27	15,6x1,78	415	6000	
CX0812MRS	12,5	1/2"	-08	1 3/16"-12	-12	37	70	32	18,77x1,78	415	6000	
CX1010MRS	16	5/8"	-10	1"-14	-10	34	70	27	15,6x1,78	350	5000	
CX1012MRS	16	5/8"	-10	1 3/16"-12	-12	37	73	32	18,77x1,78	350	5000	
CX1212MRS	19	3/4"	-12	1 3/16"-12	-12	38	78,5	32	18,77x1,78	350	5000	
CX1216MRS	19	3/4"	-12	1 7/16"-12	-16	42,5	83	41	23,52x1,78	350	5000	
CX1616MRS	25	1"	-16	1 7/16"-12	-16	44	95	41	23,52x1,78	280	4000	
CX2020MRS	31,5	1 1/4"	-20	1 11/16"-12	-20	46	104	46	29,87x1,78	210	3000	
CX2424MRS	38	1 1/2"	-24	2"-12	-24	50	115	55	37,82x1,78	185	2700	

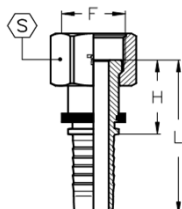
FRS
ORFS FEMALE - SLIP-ON NUT
FEMMINA ORFS - DADO LIBERO
DK ORFS

TIEFFE Part.N.	Hose Size			ORFS Connection Size		Dimensions (mm)					Maximum W.P.	
	DN	Inch	Dash	F	Dash	H	L	S			bar	PSI
CX040FRS	6	1/4"	-04	9/16"-18	-04	22,5	50,5	17			450	6500
CX0406FRS	6	1/4"	-04	11/16"-16	-06	25	53	22			450	6500
CX0506FRS	8	5/16"	-05	11/16"-16	-06	25	53	22			350	5000
CX0606FRS	10	3/8"	-06	11/16"-16	-06	24,5	55	22			450	6500
CX0608FRS	10	3/8"	-06	13/16"-16	-08	28,5	59	24			450	6500
CX0610FRS	10	3/8"	-06	1"-14	-10	32,5	63	30			450	6500
CX0808FRS	12,5	1/2"	-08	13/16"-16	-08	28,5	61,5	24			415	6000
CX0810FRS	12,5	1/2"	-08	1"-14	-10	33	66	30			415	6000
CX0812FRS	12,5	1/2"	-08	1 3/16"-12	-12	35,5	68,5	36			415	6000
CX1010FRS	16	5/8"	-10	1"-14	-10	33	68,5	30			350	5000
CX1012FRS	16	5/8"	-10	1 3/16"-12	-12	35,5	71,5	36			350	5000
CX1212FRS	19	3/4"	-12	1 3/16"-12	-12	37,5	78	36			350	5000
CX1216FRS	19	3/4"	-12	1 7/16"-12	-16	39	79,5	41			350	5000
CX1616FRS	25	1"	-16	1 7/16"-12	-16	39,5	90,5	41			280	4000
CX1620FRS	25	1"	-16	1 11/16"-12	-20	40	91	50			280	4000
CX2020FRS	31,5	1 1/4"	-20	1 11/16"-12	-20	40	97,5	50			210	3000
CX2424FRS	38	1 1/2"	-24	2"-12	-24	40	105	60			185	2700

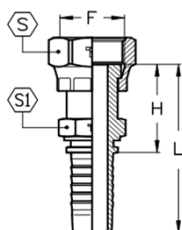
FRC
ORFS FEMALE - DOUBLE EXAGON - CRIMPED-BACK NUT
FEMMINA ORFS - DOPPIO ESAGONO - DADO PRESSATO
DK ORFS

TIEFFE Part.N.	Hose Size			ORFS Connection Size		Dimensions (mm)					Maximum W.P.		
	DN	Inch	Dash	F	Dash	H	L	S	S1			bar	PSI
CX0404FRC	6,3	1/4"	-04	9/16"-18	-04	26,5	54,5	17	14			450	6500
CX0406FRC	6,3	1/4"	-04	11/16"-16	-06	28,5	56,5	22	16			450	6500
CX0504FRC	8	5/16"	-05	9/16"-18	-04	26,5	54,5	17	14			350	5000
CX0506FRC	8	5/16"	-05	11/16"-16	-06	28,5	56,5	22	16			350	5000
CX0604FRC	10	3/8"	-06	9/16"-18	-04	26,5	57	17	16			450	6500
CX0606FRC	10	3/8"	-06	11/16"-16	-06	28,5	59	22	16			450	6500
CX0608FRC	10	3/8"	-06	13/16"-16	-08	32,5	63	24	19			450	6500
CX0806FRC	12,5	1/2"	-08	11/16"-16	-06	30,5	63,5	22	19			415	6000
CX0808FRC	12,5	1/2"	-08	13/16"-16	-08	33,5	66,5	24	19			415	6000
CX0810FRC	12,5	1/2"	-08	1"-14	-10	39,5	72,5	30	24			415	6000
CX0812FRC	12,5	1/2"	-08	1 3/16"-12	-12	43,5	76,5	36	27			415	6000
CX1010FRC	16	5/8"	-10	1"-14	-10	39,5	75,5	30	24			350	5000
CX1012FRC	16	5/8"	-10	1 3/16"-12	-12	43,5	79,5	36	27			350	5000
CX1210FRC	19	3/4"	-12	1"-14	-10	41,5	82	30	27			350	5000
CX1212FRC	19	3/4"	-12	1 3/16"-12	-12	44,5	85	36	27			350	5000
CX1216FRC	19	3/4"	-12	1 7/16"-12	-16	47,5	88	41	36			350	5000
CX1612FRC	25	1"	-16	1 3/16"-12	-12	47	98	36	32			280	4000
CX1616FRC	25	1"	-16	1 7/16"-12	-16	49	100	41	36			280	4000
CX1620FRC	25	1"	-16	1 11/16"-12	-20	50,5	102	50	41			280	4000
CX2020FRC	31,5	1 1/4"	-20	1 11/16"-12	-20	51	109	50	41			210	3000
CX2424FRC	38	1 1/2"	-24	2"-12	-24	54,5	119	60	50			185	2700

FRS45
ORFS FEMALE - 45° ELBOW - SLIP-ON NUT
 FEMMINA ORFS - CURVA A 45° - DADO LIBERO

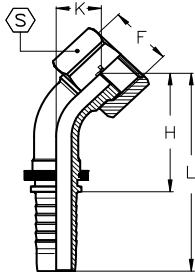
DKORFS45

* - Crimped back nut
Dado pressato

TIEFFE Part.N.	Hose Size			ORFS Connection Size		Dimensions (mm)						Maximum W.P.	
	DN	Inch	Dash	F	Dash	H	L	K	S			bar	PSI
CX0404FRS45	6,3	1/4"	-04	9/16"-18	-04	32,5	60,5	10,5	17			450	6500
CX0406FRS45	6,3	1/4"	-04	11/16"-16	-06	34,5	62,5	12,5	22			450	6500
CX0504FRS45 *	8	5/16"	-05	9/16"-18	-04	33,5	61,5	11	17			350	5000
CX0506FRS45	8	5/16"	-05	11/16"-16	-06	35	63	12,5	22			350	5000
CX0604FRS45 *	10	3/8"	-06	9/16"-18	-04	35	65,5	11,5	17			450	6500
CX0606FRS45	10	3/8"	-06	11/16"-16	-06	36	66,5	12,5	22			450	6500
CX0608FRS45	10	3/8"	-06	13/16"-16	-08	38,5	69	15	24			450	6500
CX0808FRS45	12,5	1/2"	-08	13/16"-16	-08	42,5	75,5	15,5	24			415	6000
CX0810FRS45	12,5	1/2"	-08	1"-14	-10	45	78	17,5	30			415	6000
CX0812FRS45	12,5	1/2"	-08	1 3/16"-12	-12	47	80	20,5	36			415	6000
CX1010FRS45	16	5/8"	-10	1"-14	-10	49	85	18	30			350	5000
CX1012FRS45	16	5/8"	-10	1 3/16"-12	-12	51,5	87,5	20,5	36			350	5000
CX1212FRS45	19	3/4"	-12	1 3/16"-12	-12	58	99	21	36			350	5000
CX1216FRS45	19	3/4"	-12	1 7/16"-12	-16	60,5	101	23,5	41			350	5000
CX1616FRS45	25	1"	-16	1 7/16"-12	-16	73	124	24	41			280	4000
CX1620FRS45	25	1"	-16	1 11/16"-12	-20	75	126	26,5	50			280	4000
CX2020FRS45	31,5	1 1/4"	-20	1 11/16"-12	-20	84	142	27	50			210	3000
CX2424FRS45	38	1 1/2"	-24	2"-12	-24	98	163	30	60			185	2700

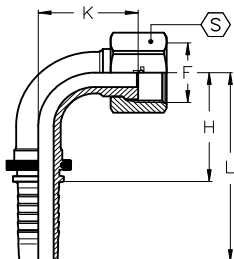
FRS90C
ORFS FEMALE - 90° ELBOW - SHORT DROP - SLIP-ON NUT
FEMMINA ORFS - CURVA A 90° - CORTA - DADO LIBERO
DK ORFS 90
SHORT DROP

* - Crimped back nut

* - Dado pressato

TIEFFE Part.N.	Hose Size			ORFS Connection Size		Dimensions (mm)					Maximum W.P.		
	DN	Inch	Dash	F	Dash	H	L	K	S		bar	PSI	
CX0404FRS90C	6,3	1/4"	-04	9/16"-18	-04	27	55	21	17			450	6500
CX0406FRS90C	6,3	1/4"	-04	11/16"-16	-06	27	55	24	22			450	6500
CX0504FRS90C *	8	5/16"	-05	9/16"-18	-04	29	57	23	17			350	5000
CX0506FRS90C	8	5/16"	-05	11/16"-16	-06	29	57	25	22			350	5000
CX0604FRS90C *	10	3/8"	-06	9/16"-18	-04	30	60,5	22	17			450	6500
CX0606FRS90C	10	3/8"	-06	11/16"-16	-06	31,5	62	24,5	22			450	6500
CX0608FRS90C	10	3/8"	-06	13/16"-16	-08	31	61	30	24			450	6500
CX0808FRS90C	12,5	1/2"	-08	13/16"-16	-08	39	72	31	24			415	6000
CX0810FRS90C	12,5	1/2"	-08	1"-14	-10	39	72	34	30			415	6000
CX0812FRS90C	12,5	1/2"	-08	1 3/16"-12	-12	39	72	42	36			415	6000
CX1010FRS90C	16	5/8"	-10	1"-14	-10	45	81	35	30			350	5000
CX1012FRS90C	16	5/8"	-10	1 3/16"-12	-12	45	81	42	36			350	5000
CX1212FRS90C	19	3/4"	-12	1 3/16"-12	-12	55	95	45	36			350	5000
CX1216FRS90C	19	3/4"	-12	1 7/16"-12	-16	55	95	49	41			350	5000
CX1616FRS90C	25	1"	-16	1 7/16"-12	-16	71	122	55	41			350	5000
CX1620FRS90C	25	1"	-16	1 11/16"-12	-20	71	122	58	50			280	4000
CX2020FRS90C	31,5	1 1/4"	-20	1 11/16"-12	-20	86	143	63	50			210	3000
CX2424FRS90C	38	1 1/2"	-24	2"-12	-24	102	167	73	60			185	2700

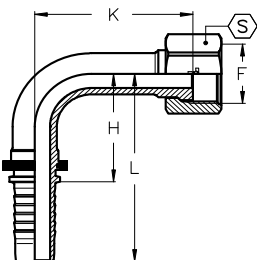
FRS90L
ORFS FEMALE - 90° ELBOW - LONG DROP - SLIP-ON NUT
FEMMINA ORFS - CURVA A 90° - LUNGA - DADO LIBERO
DK ORFS 90
LONG DROP

TIEFFE Part.N.	Hose Size			ORFS Connection Size		Dimensions (mm)					Maximum W.P.		
	DN	Inch	Dash	F	Dash	H	L	K	S		bar	PSI	
CX0404FRS90L	6,3	1/4"	-04	9/16"-18	-04	29	57	46	17			450	6500
CX0406FRS90L	6,3	1/4"	-04	11/16"-16	-06	27	55	54	22			450	6500
CX0606FRS90L	10	3/8"	-06	11/16"-16	-06	34	64,5	54	22			450	6500
CX0608FRS90L	10	3/8"	-06	13/16"-16	-08	34	64,5	64	24			450	6500
CX0808FRS90L	12,5	1/2"	-08	13/16"-16	-08	39	72	64	24			415	6000
CX0810FRS90L	12,5	1/2"	-08	1"-14	-10	39	72	70	30			415	6000
CX1010FRS90L	16	5/8"	-10	1"-14	-10	45	81	70	30			350	5000
CX1212FRS90L	19	3/4"	-12	1 3/16"-12	-12	55	95	96	36			350	5000
CX1616FRS90L	25	1"	-16	1 7/16"-12	-16	71	122	114	41			280	4000

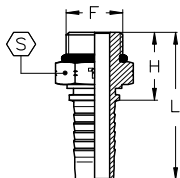
MS
SAE O' RING BOSS MALE
MASCHIO SAE O' RING

TIEFFE Part.N.	Hose Size			SAE Connection Size		Dimensions (mm)						Maximum W.P.	
	DN	Inch	Dash	F	Dash	H	L	S			O-RING	bar	PSI
CX0404MS	6,3	1/4"	-04	7/16"-20	-04	21,5	49,5	14			8,92x1,83	400	5800
CX0405MS	6,3	1/4"	-04	1/2"-20	-05	22	50	16			10,52x1,83	400	5800
CX0406MS	6,3	1/4"	-04	9/16"-18	-06	23,5	51,5	17			11,89x1,98	350	5000
CX0506MS	8	5/16"	-05	9/16"-18	-06	23,5	51,5	17			11,89x1,98	350	5000
CX0606MS	10	3/8"	-06	9/16"-18	-06	23,5	54	17			11,89x1,98	350	5000
CX0608MS	10	3/8"	-06	3/4"-16	-08	26	56,5	22			16,36x2,21	350	5000
CX0808MS	12,5	1/2"	-08	3/4"-16	-08	27	60	22			16,36x2,21	350	5000
CX0810MS	12,5	1/2"	-08	7/8"-14	-10	29,5	62,5	25			19,18x2,46	350	5000
CX0812MS	12,5	1/2"	-08	1 1/16"-12	-12	33,5	66,5	32			23,47x2,95	350	5000
CX1010MS	16	5/8"	-10	7/8"-14	-10	30	65,5	25			19,18x2,46	350	5000
CX1012MS	16	5/8"	-10	1 1/16"-12	-12	34	69,5	32			23,47x2,95	350	5000
CX1212MS	19	3/4"	-12	1 1/16"-12	-12	34,5	75	32			23,47x2,95	350	5000
CX1216MS	19	3/4"	-12	1 5/16"-12	-16	36	76,5	38			29,74x2,95	280	4000
CX1616MS	25	1"	-16	1 5/16"-12	-16	37,5	88,5	38			29,74x2,95	280	4000

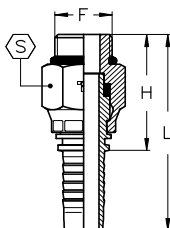
SMS
SAE O'RING BOSS SWIVEL MALE
MASCHIO GIREVOLE SAE O'RING

TIEFFE Part.N.	Hose Size			SAE Connection Size		Dimensions (mm)						Maximum W.P.	
	DN	Inch	Dash	F	Dash	H	L	S			O-RING	bar	PSI
CX0404SMS	6,3	1/4"	-04	7/16"-20	-04	37	65	17			8,92x1,83	210	3000
CX0606SMS	10	3/8"	-06	9/16"-18	-06	42	73	22			11,89x1,98	210	3000
CX0608SMS	10	3/8"	-06	3/4"-16	-08	47	80	27			16,36x2,21	210	3000
CX0808SMS	12,5	1/2"	-08	3/4"-16	-08	49	82	27			16,36x2,21	210	3000
CX0810SMS	12,5	1/2"	-08	7/8"-14	-10	50	83	27			19,18x2,46	210	3000
CX1212SMS	19	3/4"	-12	1 1/16"-12	-12	59	99	34			23,47x2,95	175	2500

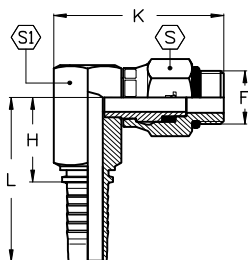
SMS90
SAE O'RING BOSS SWIVEL MALE - 90° COMPACT ELBOW
MASCHIO GIREVOLE SAE O'RING - CURVA A 90° COMPATTA

TIEFFE Part.N.	Hose Size			SAE Connection Size		Dimensions (mm)					Maximum W.P.		
	DN	Inch	Dash	F	Dash	H	L	K	S	S1	O-RING	bar	PSI
CX0606SMS90	10	3/8"	-06	9/16"-18	-06	31	61	47	22	22	11,89x1,98	210	3000
CX0608SMS90	10	3/8"	-06	3/4"-16	-08	34	64	54	27	25	16,36x2,21	210	3000
CX0808SMS90	12,5	1/2"	-08	3/4"-16	-08	33	66	54	27	25	16,36x2,21	210	3000
CX0810SMS90	12,5	1/2"	-08	7/8"-14	-10	33	66	56	27	25	19,18x2,46	210	3000
CX1212SMS90	19	3/4"	-12	1 1/16"-12	-12	43	84	67	34	32	23,47x2,95	175	2500

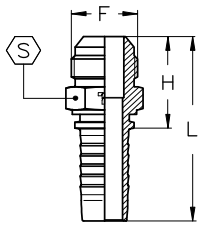
MJ

SAE MALE 45° CONE
 MASCHIO SAE CONO 45°

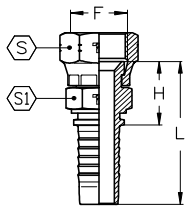
TIEFFE Part.N.	Hose Size			SAE 45° Connection Size		Dimensions (mm)					Maximum W.P.	
	DN	Inch	Dash	F	Dash	H	L	S			bar	PSI
CX0507MJ	8	5/16"	-05	5/8"-18	-07	28,2	56,2	16			400	5800
CX0607MJ	10	3/8"	-06	5/8"-18	-07	28,2	58,7	16			350	5000
CX1212MJ	19	3/4"	-12	1 1/16"-14	-12	43,4	83,9	27			350	5000

FJCP

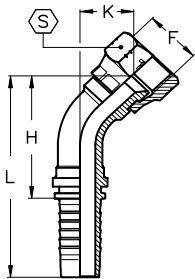
SAE FEMALE 45° CONE SEAT - DOUBLE EXAGON - CRIMPED BACK NUT
 FEMMINA SAE SVASATA 45° - DOPPIO ESAGONO - DADO PRESSATO

TIEFFE Part.N.	Hose Size			SAE 45° Connection Size		Dimensions (mm)					Maximum W.P.	
	DN	Inch	Dash	F	Dash	H	L	S	S1		bar	PSI
CX0507FJCP	8	5/16"	-05	5/8"-18	-07	23,5	51,5	22	16		400	5800
CX0607FJCP	10	3/8"	-06	5/8"-18	-07	23,5	54	22	16		350	5000
CX1212FJCP	19	3/4"	-12	1 1/16"-14	-12	31,8	72,3	32	27		350	5000

FJP45

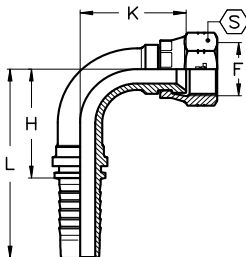
SAE FEMALE 45° CONE SEAT - 45° ELBOW - CRIMPED BACK NUT
 FEMMINA SAE SVASATA 45° - CURVA A 45° - DADO PRESSATO

TIEFFE Part.N.	Hose Size			SAE 45° Connection Size		Dimensions (mm)					Maximum W.P.	
	DN	Inch	Dash	F	Dash	H	L	K	S		bar	PSI
CX0507FJP45	8	5/16"	-05	5/8"-18	-07	38	66	16	22		400	5800
CX0607FJP45	10	3/8"	-06	5/8"-18	-07	39	69,5	16	22		350	5000
CX1212FJP45	19	3/4"	-12	1 1/16"-14	-12	62	103	25	32		350	5000

FJP90

SAE FEMALE 45° CONE SEAT - 90° ELBOW - CRIMPED BACK NUT
 FEMMINA SAE SVASATA 45° - CURVA A 90° - DADO PRESSATO

TIEFFE Part.N.	Hose Size			SAE 45° Connection Size		Dimensions (mm)					Maximum W.P.	
	DN	Inch	Dash	F	Dash	H	L	K	S		bar	PSI
CX0507FJP90	8	5/16"	-05	5/8"-18	-07	28	56	29	22		400	5800
CX0607FJP90	10	3/8"	-06	5/8"-18	-07	31	61	31	22		350	5000
CX1212FJP90	20	3/4"	-12	1 1/16"-14	-12	55	95	51	32		350	5000

FL	SAE CODE 61 FLANGE FLANGIA SAE CODE 61											SFL	
	TIEFFE Part.N.	Hose Size			Flange Size Connection		Dimensions (mm)					Maximum W.P.	
		DN	Inch	Dash	Inch	Dash	H	L	A			bar	PSI
	CX0808FL	12,5	1/2"	-08	1/2"	-08	47	80	30,2			350	5000
	CX0810FL *	12,5	1/2"	-08	5/8"	-10	47	80	34			350	5000
	CX0812FL	12,5	1/2"	-08	3/4"	-12	47	80	38,1			350	5000
	CX1008FL	16	5/8"	-10	1/2"	-08	48	84	30,2			350	5000
	CX1010FL *	16	5/8"	-10	5/8"	-10	48	84	34			350	5000
	CX1012FL	16	5/8"	-10	3/4"	-12	48	84	38,1			350	5000
	CX1208FL	19	3/4"	-12	1/2"	-08	49,5	90	30,2			350	5000
	CX1212FL	19	3/4"	-12	3/4"	-12	54	94,5	38,1			350	5000
	CX1216FL	19	3/4"	-12	1"	-16	54	94,5	44,5			350	5000
	CX1612FL	25	1"	-16	3/4"	-12	55	106	38,1			280	4000
	CX1616FL	25	1"	-16	1"	-16	55	106	44,5			280	4000
	CX1620FL	25	1"	-16	1 1/4"	-20	55	106	50,8			280	4000
	CX2016FL	31,5	1 1/4"	-20	1"	-16	62	120	44,5			210	3000
	CX2020FL	31,5	1 1/4"	-20	1 1/4"	-20	62	120	50,8			210	3000
	CX2024FL	31,5	1 1/4"	-20	1 1/2"	-24	62	120	60,3			210	3000
	CX2424FL	38	1 1/2"	-24	1 1/2"	-24	67,5	132	60,3			185	2700
	CX2432FL	38	1 1/2"	-24	2"	-32	67,5	132	71,4			185	2700
	CX3232FL	51	2"	-32	2"	-32	70	140	71,4			175	2500
	CX3240FL	51	2"	-32	2 1/2"	-40	80	150	84,1			175	2500

* Komatsu style flange
* Flangia Komatsu

FL45	SAE CODE 61 FLANGE - 45° ELBOW FLANGIA SAE CODE 61 - CURVA A 45°											SFL45	
	TIEFFE Part.N.	Hose Size			Flange Size Connection		Dimensions (mm)					Maximum W.P.	
		DN	Inch	Dash	Inch	Dash	H	L	K	A		bar	PSI
	CX0808FL45	12,5	1/2"	-08	1/2"	-08	47	80	20	30,2		350	5000
	CX0810FL45 *	12,5	1/2"	-08	5/8"	-10	48	81	22	34		350	5000
	CX0812FL45	12,5	1/2"	-08	3/4"	-12	51	84	24	38,1		350	5000
	CX1008FL45	16	5/8"	-10	1/2"	-08	51	87	21	30,2		350	5000
	CX1010FL45 *	16	5/8"	-10	5/8"	-10	53	89	22	34		350	5000
	CX1012FL45	16	5/8"	-10	3/4"	-12	55	91	24	38,1		350	5000
	CX1208FL45	19	3/4"	-12	1/2"	-08	64	104	26	30,2		350	5000
	CX1212FL45	19	3/4"	-12	3/4"	-12	62	102	25	38,1		350	5000
	CX1216FL45	19	3/4"	-12	1"	-16	64	104	27	44,5		350	5000
	CX1612FL45	25	1"	-16	3/4"	-12	80	131	30	38,1		280	4000
	CX1616FL45	25	1"	-16	1"	-16	77	128	28	44,5		280	4000
	CX1620FL45	25	1"	-16	1 1/4"	-20	77	128	28	50,8		280	4000
	CX2016FL45	31,5	1 1/4"	-20	1"	-16	94	152	37	44,5		210	3000
	CX2020FL45	31,5	1 1/4"	-20	1 1/4"	-20	88	146	32	50,8		210	3000
	CX2024FL45	31,5	1 1/4"	-20	1 1/2"	-24	88	146	32	60,3		210	3000
	CX2424FL45	38	1 1/2"	-24	1 1/2"	-24	105	169	37	60,3		185	2700
	CX2432FL45	38	1 1/2"	-24	2"	-32	105	169	37	71,4		185	2700
	CX3232FL45	51	2"	-32	2"	-32	144	214	55	71,4		175	2500
	CX3240FL45	51	2"	-32	2 1/2"	-40	142	212	53	84,1		175	2500

* Komatsu style flange
* Flangia Komatsu

FL90
SAE CODE 61 FLANGE - 90° ELBOW
 FLANGIA SAE CODE 61 - CURVA A 90°

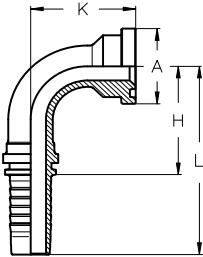
SFL90

* Komatsu style flange
* Flangia Komatsu

TIEFFE Part.N.	Hose Size			Flange Size Connection		Dimensions (mm)					Maximum W.P.		
	DN	Inch	Dash	Inch	Dash	H	L	K	A		bar	PSI	
CX0808FL90	12,5	1/2"	-08	1/2"	-08	38	71	40	30,2			350	5000
CX0810FL90 *	12,5	1/2"	-08	5/8"	-10	38	71	42	34			350	5000
CX0812FL90	12,5	1/2"	-08	3/4"	-12	38	71	45	38,1			350	5000
CX1008FL90	16	5/8"	-10	1/2"	-08	45	81	42	30,2			350	5000
CX1010FL90 *	16	5/8"	-10	5/8"	-10	45	81	44	34			350	5000
CX1012FL90	16	5/8"	-10	3/4"	-12	45	81	47	38,1			350	5000
CX1208FL90	19	3/4"	-12	1/2"	-08	55	95	54	30,2			350	5000
CX1212FL90	19	3/4"	-12	3/4"	-12	55	95	51	38,1			350	5000
CX1216FL90	19	3/4"	-12	1"	-16	55	95	54	44,5			280	4000
CX1612FL90	25	1"	-16	3/4"	-12	70	121	65	38,1			280	4000
CX1616FL90	25	1"	-16	1"	-16	70	121	61	44,5			280	4000
CX1620FL90	25	1"	-16	1 1/4"	-20	70	121	61	50,8			280	4000
CX2016FL90	31,5	1 1/4"	-20	1"	-16	85	142	78	44,5			210	3000
CX2020FL90	31,5	1 1/4"	-20	1 1/4"	-20	85	142	70	50,8			210	3000
CX2024FL90	31,5	1 1/4"	-20	1 1/2"	-24	85	142	70	60,3			210	3000
CX2424FL90	38	1 1/2"	-24	1 1/2"	-24	105	170	83	60,3			185	2700
CX2432FL90	38	1 1/2"	-24	2"	-32	105	170	83	71,4			185	2700
CX3232FL90	51	2"	-32	2"	-32	140	210	122	71,4			175	2500
CX3240FL90	51	2"	-32	2 1/2"	-40	140	210	120	84,1			175	2500

FL 90

LONG DROP

SAE CODE 61 FLANGE - 90° ELBOW - LONG DROP
 FLANGIA SAE CODE 61 - CURVA A 90° - LUNGA

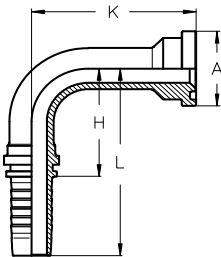
SFL90
 LONG DROP

TIEFFE Part.N.	Hose Size			Flange Size Connection		Dimensions (mm)					Maximum W.P.		
	DN	Inch	Dash	Inch	Dash	H	L	K	A		bar	PSI	
CX0808FL90-K83	12,5	1/2"	-08	1/2"	-08	38	71	83	30,2			350	5000
CX1212FL90-K96	19	3/4"	-12	3/4"	-12	55	95	96	38,1			350	5000
CX1212FL90-K127	19	3/4"	-12	3/4"	-12	55	95	127	38,1			350	5000
CX1216FL90-K79	19	3/4"	-12	1"	-16	55	95	79	44,5			280	4000
CX1616FL90-K118	25	1"	-25	1"	-16	70	121	118	44,5			280	4000
CX1620FL90-K118	25	1"	-25	1 1/4"	-20	70	121	118	50,8			280	4000
CX2020FL90-K91	31,5	1 1/4"	-20	1 1/4"	-20	85	142	91	50,8			210	3000
CX2020FL90-K102	31,5	1 1/4"	-20	1 1/4"	-20	85	142	102	50,8			210	3000
CX2020FL90-K112	31,5	1 1/4"	-20	1 1/4"	-20	85	142	112	50,8			210	3000
CX2020FL90-K130	31,5	1 1/4"	-20	1 1/4"	-20	85	142	130	50,8			210	3000
CX2020FL90-K168	31,5	1 1/4"	-20	1 1/4"	-20	85	142	168	50,8			210	3000
CX2024FL90-K118	31,5	1 1/4"	-20	1 1/2"	-24	85	142	118	60,3			210	3000
CX2024FL90-K130	31,5	1 1/4"	-20	1 1/2"	-24	85	142	130	60,3			210	3000
CX2424FL90-K148	38	1 1/2"	-24	1 1/2"	-24	105	170	148	60,3			185	2700
CX2424FL90-K172	38	1 1/2"	-24	1 1/2"	-24	105	170	172	60,3			185	2700
CX2432FL90-K115	38	1 1/2"	-24	2"	-32	105	170	115	71,4			185	2700
CX2432FL90-K172	38	1 1/2"	-24	2"	-32	105	170	172	71,4			185	2700
CX3232FL90-K165	51	2"	-32	2"	-32	140	210	165	71,4			175	2500
CX3232FL90-K203	51	2"	-32	2"	-32	140	210	203	71,4			175	2500

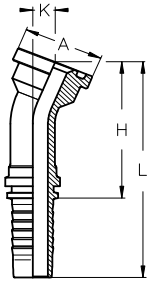
FL22
SAE CODE 61 FLANGE - 22,5° ELBOW
FLANGIA SAE CODE 61 - CURVA A 22,5°
SFL22,5

TIEFFE Part.N.	Hose Size			Flange Size Connection		Dimensions (mm)					Maximum W.P.	
	DN	Inch	Dash	Inch	Dash	H	L	K	A		bar	PSI
CX0808FL22	12,5	1/2"	-08	1/2"	-08	53	86	10	30,2		350	5000
CX0812FL22	12,5	1/2"	-08	3/4"	-12	58	91	11	38,1		350	5000
CX1212FL22	19	3/4"	-12	3/4"	-12	69	110	11	38,1		350	5000
CX1216FL22	19	3/4"	-12	1"	-16	72	112	12	44,5		350	5000
CX1616FL22	25	1"	-16	1"	-16	84	135	12	44,5		280	4000
CX1620FL22	25	1"	-16	1 1/4"	-20	84	135	12	50,8		280	3000
CX2020FL22	31,5	1 1/4"	-20	1 1/4"	-20	97	155	14	50,8		210	3000
CX2024FL22	31,5	1 1/4"	-20	1 1/2"	-24	97	155	14	60,3		210	3000
CX2424FL22	38	1 1/2"	-24	1 1/2"	-24	113	178	18	60,3		185	2700
CX3232FL22	51	2"	-32	2"	-32	159	229	23	71,4		175	2500

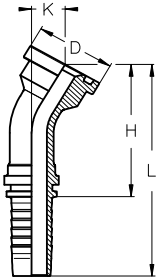
FL30
SAE CODE 61 FLANGE - 30° ELBOW
FLANGIA SAE CODE 61 - CURVA A 30°
SFL30

TIEFFE Part.N.	Hose Size			Flange Size Connection		Dimensions (mm)					Maximum W.P.	
	DN	Inch	Dash	Inch	Dash	H	L	K	A		bar	PSI
CX0808FL30	12,5	1/2"	-08	1/2"	-08	51	84	13	30,2		350	5000
CX0812FL30	12,5	1/2"	-08	3/4"	-12	56	89	16	38,1		350	5000
CX1212FL30	19	3/4"	-12	3/4"	-12	65	106	16	38,1		350	5000
CX1216FL30	19	3/4"	-12	1"	-16	68	108	17	44,5		350	5000
CX1616FL30	25	1"	-16	1"	-16	82	133	17	44,5		280	4000
CX1620FL30	25	1"	-16	1 1/4"	-20	82	133	17	50,8		280	3000
CX2020FL30	31,5	1 1/4"	-20	1 1/4"	-20	95	153	19	50,8		210	3000
CX2024FL30	31,5	1 1/4"	-20	1 1/2"	-24	95	153	19	60,3		210	3000
CX2424FL30	38	1 1/2"	-24	1 1/2"	-24	111	175	25	60,3		185	2700
CX3232FL30	51	2"	-32	2"	-32	156	226	33	71,4		175	2500

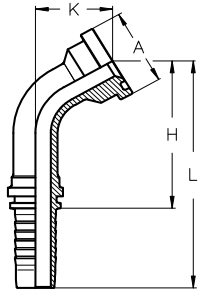
FL60
SAE CODE 61 FLANGE - 60° ELBOW
FLANGIA SAE CODE 61 - CURVA A 60°
SFL60

TIEFFE Part.N.	Hose Size			Flange Size Connection		Dimensions (mm)					Maximum W.P.	
	DN	Inch	Dash	Inch	Dash	H	L	K	A		bar	PSI
CX0808FL60	12,5	1/2"	-08	1/2"	-08	55	88	27	30,2		350	5000
CX0812FL60	12,5	1/2"	-08	3/4"	-12	58	91	32	38,1		350	5000
CX1212FL60	19	3/4"	-12	3/4"	-12	73	113	34	38,1		350	5000
CX1216FL60	19	3/4"	-12	1"	-16	74	114	36	44,5		350	5000
CX1616FL60	25	1"	-16	1"	-16	97	148	39	44,5		280	4000
CX1620FL60	25	1"	-16	1 1/4"	-20	97	148	39	50,8		280	3000
CX2020FL60	31,5	1 1/4"	-20	1 1/4"	-20	115	173	44	50,8		210	3000
CX2024FL60	31,5	1 1/4"	-20	1 1/2"	-24	115	173	44	60,3		210	3000
CX2424FL60	38	1 1/2"	-24	1 1/2"	-24	137	201	51	60,3		185	2700
CX3232FL60	51	2"	-32	2"	-32	188	258	77	71,4		175	2500

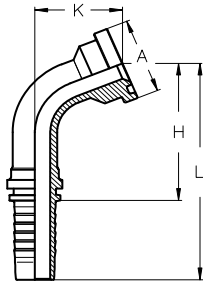
FL67
SAE CODE 61 FLANGE - 67,5° ELBOW
FLANGIA SAE CODE 61 - CURVA A 67,5°
SFL67,5

TIEFFE Part.N.	Hose Size			Flange Size Connection		Dimensions (mm)					Maximum W.P.	
	DN	Inch	Dash	Inch	Dash	H	L	K	A		bar	PSI
CX0808FL67	12,5	1/2"	-08	1/2"	-08	51	84	30	30,2		350	5000
CX0812FL67	12,5	1/2"	-08	3/4"	-12	54	87	36	38,1		350	5000
CX1212FL67	19	3/4"	-12	3/4"	-12	68	108	38	38,1		350	5000
CX1216FL67	19	3/4"	-12	1"	-16	69	109	41	44,5		350	5000
CX1616FL67	25	1"	-16	1"	-16	91	142	44	44,5		280	4000
CX1620FL67	25	1"	-16	1 1/4"	-20	91	142	44	50,8		280	3000
CX2020FL67	31,5	1 1/4"	-20	1 1/4"	-20	109	167	51	50,8		210	3000
CX2024FL67	31,5	1 1/4"	-20	1 1/2"	-24	109	167	51	60,3		210	3000
CX2424FL67	38	1 1/2"	-24	1 1/2"	-24	129	194	59	60,3		185	2700
CX3232FL67	51	2"	-32	2"	-32	177	247	87	71,4		175	2500

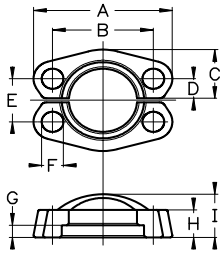
13SL
SAE CODE 61 SPLIT FLANGE CLAMPS
COPPIA SEMIFLANGE SAE CODE 61

TIEFFE Part.N.	Flange Size Connection		Dimensions (mm)									
	Inch	Dash	A	B	C	D	E	F	G	H	I	
13SL08	1/2"	08	54	38,1	21,8	8	17,5	9	6,2	13	19	
13SL12	3/4"	12	65	47,6	24,9	10	22,3	11	6,2	14	22	
13SL16	1"	16	69,8	52,4	28,2	12	26,2	11	7,5	16	24	
13SL20	1 1/4"	20	79,4	58,7	35,3	14	30,2	11	7,5	16	24	
13SL24	1 1/2"	24	93,7	69,9	40,1	17	35,7	13	7,5	16	25	
13SL32	2"	32	101,6	77,8	47,2	21	42,9	13	9	16	26	
13SL40	2 1/2"	40	114,3	88,9	53,1	24	50,8	13	9	19	38	
13SL48	3"	48	135	106,4	64,3	30	61,9	17	9	22	41	

OR
O'RING SEAL FOR SAE FLANGE CODE 61
GUARNIZIONI D'RING PER FLANGE SAE CODE 61

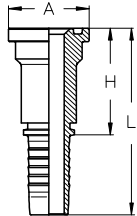

TIEFFE Part.N.	Flange Size Connection		Dimensions (mm)	
	Inch	Dash	ISO 3601-1	SAE J515
OR19x3,55	1/2"	08	19x3,55	18,64x3,53
OR25x3,55	3/4"	12	25x3,55	24,99x3,53
OR32,5x3,55	1"	16	32,5x3,55	32,92x3,53
OR37,5x3,55	1 1/4"	20	37,5x3,55	37,69x3,53
OR47,5x3,55	1 1/2"	24	47,5x3,55	47,22x3,53
OR56x3,55	2"	32	56x3,55	56,74x3,53

FP
SAE CODE 62 FLANGE
 FLANGIA SAE CODE 62

SFS

TIEFFE Part.N.	Hose Size			Flange Size Connection		Dimensions (mm)					Maximum W.P.	
	DN	Inch	Dash	Inch	Dash	H	L	A			bar	PSI
CX0808FP	12,5	1/2"	-08	1/2"	-08	47	80	31,8			415	6000
CX0812FP	12,5	1/2"	-08	3/4"	-12	47	80	41,3			415	6000
CX1008FP	16	5/8"	-10	1/2"	-08	48	84	31,8			350	5000
CX1012FP	16	5/8"	-10	3/4"	-12	48	84	41,3			350	5000
CX1208FP	19	3/4"	-12	1/2"	-08	50	90,5	31,8			350	5000
CX1212FP	19	3/4"	-12	3/4"	-12	58	98,5	41,3			350	5000
CX1216FP	19	3/4"	-12	1"	-16	58	98,5	47,6			350	5000
CX1612FP	25	1"	-16	3/4"	-12	60	115	41,3			280	4000
CX1616FP	25	1"	-16	1"	-16	64	115	47,6			280	4000
CX1620FP	25	1"	-16	1 1/4"	-20	64	115	54			280	4000
CX2016FP	31,5	1 1/4"	-20	1"	-16	67,5	125	47,6			210	3000
CX2020FP	31,5	1 1/4"	-20	1 1/4"	-20	67,5	125	54			210	3000
CX2024FP	31,5	1 1/4"	-20	1 1/2"	-24	67,5	125	63,5			210	3000
CX2424FP	38	1 1/2"	-24	1 1/2"	-24	79,5	144	63,5			185	2700
CX2432FP	38	1 1/2"	-24	2"	-32	79,5	144	79,4			185	2700
CX3232FP	51	2"	-32	2"	-32	95	165	79,4			175	2500

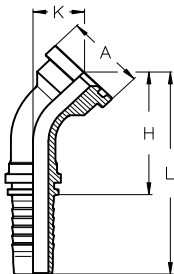
FP45
SAE CODE 62 FLANGE - 45° ELBOW
 FLANGIA SAE CODE 62 - CURVA A 45°

SFS45

TIEFFE Part.N.	Hose Size			Flange Size Connection		Dimensions (mm)					Maximum W.P.	
	DN	Inch	Dash	Inch	Dash	H	L	K	A		bar	PSI
CX0808FP45	12,5	1/2"	-08	1/2"	-08	47	80	20	31,8		415	6000
CX0812FP45	12,5	1/2"	-08	3/4"	-12	53	86	26	41,3		415	6000
CX1008FP45	16	5/8"	-10	1/2"	-08	51	87	21	31,8		350	5000
CX1012FP45	16	5/8"	-10	3/4"	-12	57	93	26	41,3		350	5000
CX1208FP45	19	3/4"	-12	1/2"	-08	64	104	26	31,8		350	5000
CX1212FP45	19	3/4"	-12	3/4"	-12	64	104	26	41,3		350	5000
CX1216FP45	19	3/4"	-12	1"	-16	68	108	31	47,6		350	5000
CX1612FP45	25	1"	-16	3/4"	-12	79	130	31	41,3		280	4000
CX1616FP45	25	1"	-16	1"	-16	80	131	32	47,6		280	4000
CX1620FP45	25	1"	-16	1 1/4"	-20	85	136	37	54		280	4000
CX2016FP45	31,5	1 1/4"	-20	1"	-16	94	152	37	47,6		210	3000
CX2020FP45	31,5	1 1/4"	-20	1 1/4"	-20	93	151	37	54		210	3000
CX2024FP45	31,5	1 1/4"	-20	1 1/2"	-24	99	157	43	63,5		210	3000
CX2424FP45	38	1 1/2"	-24	1 1/2"	-24	111	175	44	63,5		185	2700
CX2432FP45	38	1 1/2"	-24	2"	-32	122	186	55	79,4		185	2700
CX3232FP45	51	2"	-32	2"	-32	147	217	58	79,4		175	2500

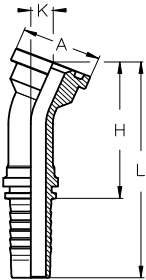
FP22
SAE CODE 62 FLANGE - 22,5° ELBOW
FLANGIA SAE CODE 62 - CURVA A 2,5°
SFS22,5

TIEFFE Part.N.	Hose Size			Flange Size Connection		Dimensions (mm)					Maximum W.P.	
	DN	Inch	Dash	Inch	Dash	H	L	K	A		bar	PSI
CX0808FP22	12,5	1/2"	-08	1/2"	-08	53	86	10	31,8		415	6000
CX0812FP22	12,5	1/2"	-08	3/4"	-12	60	93	13	41,3		415	6000
CX1212FP22	19	3/4"	-12	3/4"	-12	71	112	13	41,3		350	5000
CX1216FP22	19	3/4"	-12	1"	-16	77	117	15	47,6		350	5000
CX1616FP22	25	1"	-16	1"	-16	89	140	15	47,6		280	4000
CX1620FP22	25	1"	-16	1 1/4"	-20	95	146	17	54		280	4000
CX2020FP22	31,5	1 1/4"	-20	1 1/4"	-20	103	161	17	54		210	3000
CX2024FP22	31,5	1 1/4"	-20	1 1/2"	-24	112	169	20	63,5		210	3000
CX2424FP22	38	1 1/2"	-24	1 1/2"	-24	123	188	20	63,5		185	2700
CX3232FP22	51	2"	-32	2"	-32	163	233	25	79,4		175	2500

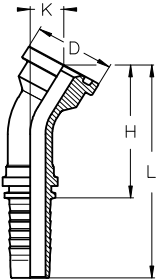
FP30
SAE CODE 62 FLANGE - 30° ELBOW
FLANGIA SAE CODE 62 - CURVA A 30°
SFS30

TIEFFE Part.N.	Hose Size			Flange Size Connection		Dimensions (mm)					Maximum W.P.	
	DN	Inch	Dash	Inch	Dash	H	L	K	A		bar	PSI
CX0808FP30	12,5	1/2"	-08	1/2"	-08	51	84	13	31,8		415	6000
CX0812FP30	12,5	1/2"	-08	3/4"	-12	58	91	17	41,3		415	6000
CX1212FP30	19	3/4"	-12	3/4"	-12	69	110	17	41,3		350	5000
CX1216FP30	19	3/4"	-12	1"	-16	75	115	20	47,6		350	5000
CX1616FP30	25	1"	-16	1"	-16	87	138	20	47,6		280	4000
CX1620FP30	25	1"	-16	1 1/4"	-20	93	144	23	54		280	4000
CX2020FP30	31,5	1 1/4"	-20	1 1/4"	-20	101	159	23	54		210	3000
CX2024FP30	31,5	1 1/4"	-20	1 1/2"	-24	109	166	28	63,5		210	3000
CX2424FP30	38	1 1/2"	-24	1 1/2"	-24	121	185	28	63,5		185	2700
CX3232FP30	51	2"	-32	2"	-32	160	230	35	79,4		175	2500

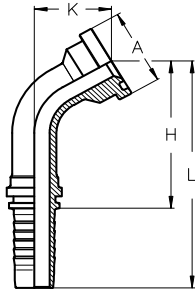
FP60
SAE CODE 62 FLANGE - 60° ELBOW
FLANGIA SAE CODE 62 - CURVA A 60°
SFS60

TIEFFE Part.N.	Hose Size			Flange Size Connection		Dimensions (mm)					Maximum W.P.	
	DN	Inch	Dash	Inch	Dash	H	L	K	A		bar	PSI
CX0808FP60	12,5	1/2"	-08	1/2"	-08	55	88	27	31,8		415	6000
CX0812FP60	12,5	1/2"	-08	3/4"	-12	59	92	34	41,3		415	6000
CX1212FP60	19	3/4"	-12	3/4"	-12	78	118	36	41,3		350	5000
CX1216FP60	19	3/4"	-12	1"	-16	81	121	41	47,6		350	5000
CX1616FP60	25	1"	-16	1"	-16	99	150	43	47,6		280	4000
CX1620FP60	25	1"	-16	1 1/4"	-20	103	154	49	54		280	4000
CX2020FP60	31,5	1 1/4"	-20	1 1/4"	-20	119	177	51	54		210	3000
CX2024FP60	31,5	1 1/4"	-20	1 1/2"	-24	123	181	58	63,5		210	3000
CX2424FP60	38	1 1/2"	-24	1 1/2"	-24	142	206	60	63,5		185	2700
CX3232FP60	51	2"	-32	2"	-32	190	260	80	79,4		175	2500

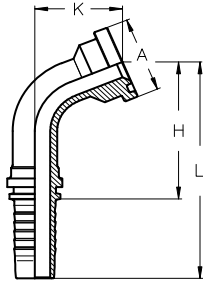
FP67
SAE CODE 62 FLANGE - 67,5° ELBOW
FLANGIA SAE CODE 62 - CURVA A 67,5°
SFS67,5

TIEFFE Part.N.	Hose Size			Flange Size Connection		Dimensions (mm)					Maximum W.P.	
	DN	Inch	Dash	Inch	Dash	H	L	K	A		bar	PSI
CX0808FP67	12,5	1/2"	-08	1/2"	-08	51	84	31	31,8		415	6000
CX0812FP67	12,5	1/2"	-08	3/4"	-12	54	87	38	41,3		415	6000
CX1212FP67	19	3/4"	-12	3/4"	-12	73	113	41	41,3		350	5000
CX1216FP67	19	3/4"	-12	1"	-16	75	116	46	47,6		350	5000
CX1616FP67	25	1"	-16	1"	-16	93	144	49	47,6		280	4000
CX1620FP67	25	1"	-16	1 1/4"	-20	96	147	56	54		280	4000
CX2020FP67	31,5	1 1/4"	-20	1 1/4"	-20	112	170	58	54		210	3000
CX2024FP67	31,5	1 1/4"	-20	1 1/2"	-24	115	173	66	63,5		210	3000
CX2424FP67	38	1 1/2"	-24	1 1/2"	-24	134	198	69	63,5		185	2700
CX3232FP67	51	2"	-32	2"	-32	179	249	92	79,4		175	2500

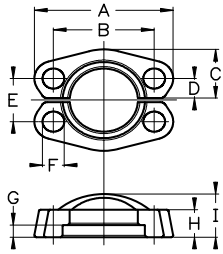
13SP
SAE CODE 62 SPLIT FLANGE CLAMPS
COPPIA SEMIFLANGE SAE CODE 62

TIEFFE Part.N.	Flange Size Connection		Dimensions (mm)										Maximum W.P.	
	Inch	Dash	A	B	C	D	E	F	G	H	I	bar	PSI	
13SP08	1/2"	08	56,3	40,5	22,6	8	18,2	9	7,2	16	22	350	5000	
13SP12	3/4"	12	71,4	50,8	29	11	23,8	11	8,2	19	28	350	5000	
13SP16	1"	16	80,9	57,2	33,8	13	27,8	13	9	24	33	350	5000	
13SP20	1 1/4"	20	95,2	66,6	37,6	15	31,8	15	9,8	27	38	350	5000	
13SP24	1 1/2"	24	112,7	79,3	46,5	17	36,5	17	12	30	43	350	5000	
13SP32	2"	32	133,4	96,8	55,9	21	44,5	22	12	37	52	350	5000	

OR
O'RING SEAL FOR SAE FLANGE CODE 62
GUARNIZIONI D'RING PER FLANGE SAE CODE 62

TIEFFE Part.N.	Flange Size Connection		Dimensions (mm)							
	Inch	Dash	ISO 3601-1	SAE J515						
OR19x3,55	1/2"	08	19x3,55	18,64x3,53						
OR25x3,55	3/4"	12	25x3,55	24,99x3,53						
OR32,5x3,55	1"	16	32,5x3,55	32,92x3,53						
OR37,5x3,55	1 1/4"	20	37,5x3,55	37,69x3,53						
OR47,5x3,55	1 1/2"	24	47,5x3,55	47,22x3,53						
OR56x3,55	2"	32	56x3,55	56,74x3,53						

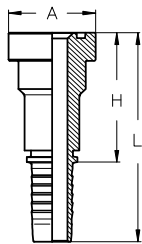
YP

"SUPERCAT" FLANGE
FLANGIA "SUPERCAT"

SFS
SUPERCAT

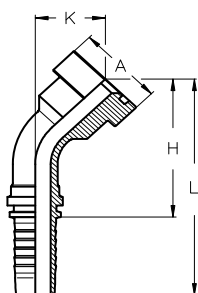
TIEFFE Part.N.	Hose Size			Flange Size Connection		Dimensions (mm)					Maximum W.P.	
	DN	Inch	Dash	Inch	Dash	H	L	A			bar	PSI
CX1212YP	19	3/4"	-12	3/4"	-12	66	106,5	41,3			350	5000
CX1216YP	19	3/4"	-12	1"	-16	68	108,5	47,6			350	5000
CX1616YP	25	1"	-16	1"	-16	72	123	47,6			280	4000
CX1620YP	25	1"	-16	1 1/4"	-20	75	126	54			280	4000
CX2020YP	31,5	1 1/4"	-20	1 1/4"	-20	75	133	54			210	3000
CX2024YP	31,5	1 1/4"	-20	1 1/2"	-24	82	140	63,5			210	3000
CX2424YP	38	1 1/2"	-24	1 1/2"	-24	83	147,5	63,5			185	2700

YP45

"SUPERCAT" FLANGE - 45° ELBOW
FLANGIA "SUPERCAT" - CURVA A45°

SFS45
SUPERCAT

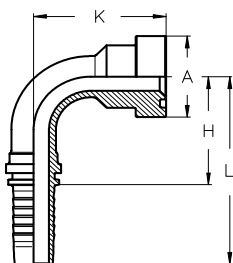
TIEFFE Part.N.	Hose Size			Flange Size Connection		Dimensions (mm)					Maximum W.P.	
	DN	Inch	Dash	Inch	Dash	H	L	K	A		bar	PSI
CX1212YP45	19	3/4"	-12	3/4"	-12	71	112	34	41,3		350	5000
CX1216YP45	19	3/4"	-12	1"	-16	74	114	36	47,6		350	5000
CX1616YP45	25	1"	-16	1"	-16	86	137	37	47,6		280	4000
CX1620YP45	25	1"	-16	1 1/4"	-20	88	139	38	54		280	4000
CX2020YP45	31,5	1 1/4"	-20	1 1/4"	-20	86	154	39	54		210	3000
CX2024YP45	31,5	1 1/4"	-20	1 1/2"	-24	102	160	45	63,5		210	3000
CX2424YP45	38	1 1/2"	-24	1 1/2"	-24	114	179	45	63,5		185	2700

YP90

"SUPERCAT" FLANGE - 90° ELBOW
FLANGIA "SUPERCAT" - CURVA A90°

SFS90
SUPERCAT

TIEFFE Part.N.	Hose Size			Flange Size Connection		Dimensions (mm)					Maximum W.P.	
	DN	Inch	Dash	Inch	Dash	H	L	K	A		bar	PSI
CX1212YP90	19	3/4"	-12	3/4"	-12	55	95	64	41,3		350	5000
CX1216YP90	19	3/4"	-12	1"	-16	55	95	67	47,6		350	5000
CX1616YP90	25	1"	-16	1"	-16	71	122	73	47,6		280	4000
CX1620YP90	25	1"	-16	1 1/4"	-20	71	122	75	54		280	4000
CX2020YP90	31,5	1 1/4"	-20	1 1/4"	-20	86	143	80	54		210	3000
CX2024YP90	31,5	1 1/4"	-20	1 1/2"	-24	86	143	89	63,5		210	3000
CX2424YP90	38	1 1/2"	-24	1 1/2"	-24	102	167	95	63,5		185	2700

OR

O'RING SEAL FOR SAE FLANGE 6000 PSI - CODE 62
GUARNIZIONI D'RING PER FLANGE SAE 6000 PSI - CODICE 62

TIEFFE Part.N.	Flange Size Connection		Dimensions (mm)									
	Inch	Dash	ISO 3601-1	SAE J515								
OR19x3,55	1/2"	08	19x3,55	18,64x3,53								
OR25x3,55	3/4"	12	25x3,55	24,99x3,53								
OR32,5x3,55	1"	16	32,5x3,55	32,92x3,53								
OR37,5x3,55	1 1/4"	20	37,5x3,55	37,69x3,53								
OR47,5x3,55	1 1/2"	24	47,5x3,55	47,22x3,53								
OR56x3,55	2"	32	56x3,55	56,74x3,53								

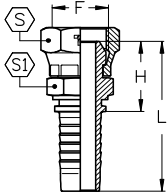
FGCP
"NISSAN" BSP FEMALE 60° CONE - DOUBLE EXAGON - CRIMPED-BACK NUT
FEMMINA GAS "NISSAN" OGIVA 60° - DOPPIO ESAGONO - DADO PRESSATO
DKR

TIEFFE Part.N.	Hose Size			BSP Connection size		Dimensions (mm)					Maximum W.P.	
	DN	Inch	Dash	F	Dash	H	L	S	S1		bar	PSI
CX0304FGCP	5	3/16"	-03	1/4"-19	-04	23	48	19	14		415	6000
CX0404FGCP	6,3	1/4"	-04	1/4"-19	-04	24	52	19	14		450	6500
CX0406FGCP	6,3	1/4"	-04	3/8"-19	-06	26	54	22	17		450	6500
CX0506FGCP	8	5/16"	-05	3/8"-19	-06	26	54	22	17		350	5000
CX0606FGCP	10	3/8"	-06	3/8"-19	-06	26	57	22	17		445	6500
CX0608FGCP	10	3/8"	-06	1/2"-14	-08	29	60	27	22		415	6000
CX0808FGCP	12,5	1/2"	-08	1/2"-14	-08	30	63	27	22		415	6000
CX1012FGCP	16	5/8"	-10	3/4"-14	-12	35	71	32	27		350	5000
CX1212FGCP	19	3/4"	-12	3/4"-14	-12	36	76	32	27		350	5000
CX1616FGCP	25	1"	-16	1"-11	-16	40	91	41	32		280	4000
CX2020FGCP	31,5	1 1/4"	-20	1 1/4"-11	-20	46	104	50	41		210	3000
CX2424FGCP	38	1 1/2"	-24	1 1/2"-11	-24	47	112	55	46		185	2700
CX3232FGCP	51	2"	-32	2"-11	-32	53	123	70	60		175	2500

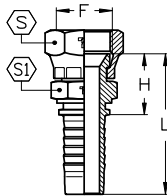
FTC
"TOYOTA" BSP FEMALE 60° CONE SEAT - DOUBLE EXAGON - CRIMPED BACK NUT
FEMMINA GAS "TOYOTA" SVASATA 60° - DOPPIO ESAGONO - DADO PRESSATO

TIEFFE Part.N.	Hose Size			BSP Connection size		Dimensions (mm)					Maximum W.P.	
	DN	Inch	Dash	F	Dash	H	L	S	S1		bar	PSI
CX0404FTC	6,3	1/4"	-04	1/4"-19	-04	21,5	49,5	19	17		350	5000
CX0606FTC	10	3/8"	-06	3/8"-19	-06	22,5	53	22	19		350	5000
CX0808FTC	12,5	1/2"	-08	1/2"-14	-08	26	59	27	22		350	5000
CX1212FTC	19	3/4"	-12	3/4"-14	-12	31	71,5	32	27		280	4000
CX1616FTC	25	1"	-16	1"-11	-16	36	87	41	36		210	3000
CX2020FTC	31,5	1 1/4"	-20	1 1/4"-11	-20	40,5	98	50	46		175	2500
CX2424FTC	38	1 1/2"	-24	1 1/2"-11	-24	42,5	107	55	50		105	1500

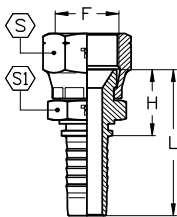
FMG
"KOMATSU" METRIC FEMALE 60° CONE SEAT - DOUBLE EXAGON - CRIMPED BACK NUT
FEMMINA METRICA "KOMATSU" SVASATA 60° - DOPPIO ESAGONO - DADO PRESSATO

TIEFFE Part.N.	Hose Size			METRIC Connection	Dimensions (mm)					Maximum W.P.	
	DN	Inch	Dash	F	H	L	S	S1		bar	PSI
CX04FMG14A	6,3	1/4"	-04	M14x1,5	21,5	49,5	19	17		350	5000
CX05FMG16A	8	5/16"	-05	M16x1,5	22	50	22	17		350	5000
CX06FMG14A	10	3/8"	-06	M14x1,5	21,5	52	19	17		350	5000
CX06FMG16A	10	3/8"	-06	M16x1,5	22	52,5	22	17		350	5000
CX06FMG18A	10	3/8"	-06	M18x1,5	22,5	53	24	19		350	5000
CX08FMG22A	12,5	1/2"	-08	M22x1,5	26	59	27	22		350	5000
CX08FMG24A	12,5	1/2"	-08	M24x1,5	30	63	32	27		350	5000
CX10FMG24A	16	5/8"	-10	M24x1,5	60	66	32	27		280	4000
CX12FMG30A	19	3/4"	-12	M30x1,5	33,5	74	36	32		280	4000
CX16FMG33A	25	1"	-16	M33x15	36	87	41	36		210	3000
CX20FMG36A	31,5	1 1/4"	-20	M36x1,5	40	97,5	46	41		175	2500
CX24FMG42A	38	1 1/2"	-24	M42x1,5	42,5	107	50	46		105	1500

MW
METRIC MALE 60° CONE SEAT
 MASCHIO METRICO SVASATO 60°

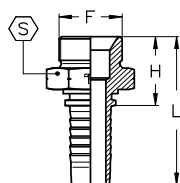
AGM

TIEFFE Part.N.	Hose Size			METRIC 60° Connection	Dimensions (mm)					Maximum W.P.	
	DN	Inch	Dash	F	H	L	S			bar	PSI
CX03MW10C	5	3/16"	-03	M10x1	18,5	43,5	14			280	4000
CX03MW12A	5	3/16"	-03	M12x1,5	23,5	48,5	17			280	4000
CX04MW10C	6,3	1/4"	-04	M10x1	19	47	14			280	4000
CX04MW12A	6,3	1/4"	-04	M12x1,5	24	52	17			280	4000
CX04MW14A	6,3	1/4"	-04	M14x1,5	24	52	19			280	4000
CX04MW16A	6,3	1/4"	-04	M16x1,5	25	53	22			280	4000
CX04MW18A	6,3	1/4"	-04	M18x1,5	26	54	24			280	4000
CX05MW14A	8	5/16"	-05	M14x1,5	24	52	19			280	4000
CX05MW16A	8	5/16"	-05	M16x1,5	25	53	22			280	4000
CX05MW18A	8	5/16"	-05	M18x1,5	26	54	24			280	4000
CX06MW14A	10	3/8"	-06	M14x1,5	24	54,5	19			280	4000
CX06MW16A	10	3/8"	-06	M16x1,5	25	55,5	22			280	4000
CX06MW18A	10	3/8"	-06	M18x1,5	26	56,5	24			280	4000
CX06MW20A	10	3/8"	-06	M20x1,5	29	59,5	27			280	4000
CX06MW22A	10	3/8"	-06	M22x1,5	29	59,5	27			280	4000
CX08MW18A	12,5	1/2"	-08	M18x1,5	27	60	24			280	4000
CX08MW20A	12,5	1/2"	-08	M20x1,5	30	63	27			280	4000
CX08MW22A	12,5	1/2"	-08	M22x1,5	30	63	27			280	4000
CX08MW24A	12,5	1/2"	-08	M24x1,5	30	63	30			280	4000
CX08MW26A	12,5	1/2"	-08	M26x1,5	33	66	32			280	4000
CX10MW22A	16	5/8"	-10	M22x1,5	30	66	27			280	4000
CX10MW24A	16	5/8"	-10	M24x1,5	30	66	30			280	4000
CX10MW26A	16	5/8"	-10	M26x1,5	33	69	32			280	4000
CX10MW27A	16	5/8"	-10	M27x1,5	33	69	32			280	4000
CX12MW26A	19	3/4"	-12	M26x1,5	34	74,5	32			280	4000
CX12MW27A	19	3/4"	-12	M27x1,5	34	74,5	32			280	4000
CX12MW30A	19	3/4"	-12	M30x1,5	35	75,5	36			210	1500
CX16MW38A	25	1"	-16	M38x1,5	38,5	89,5	46			165	2400
CX20MW45A	31,5	1 1/4"	-20	M45x1,5	41,5	99	55			125	1800
CX24MW52A	38	1 1/2"	-24	M52x1,5	42,5	107	60			90	1300

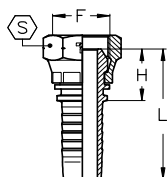
FW
METRIC FEMALE 60° CONE - CRIMPED-BACK NUT
FEMMINA METRICA OGIVA 60° - DADO PRESSATO
DKM

TIEFFE Part.N.	Hose Size			METRIC 60° Connection	Dimensions (mm)					Maximum W.P.	
	DN	Inch	Dash	F	H	L	S			bar	PSI
CX03FW10C	5	3/16"	-03	M10x1	16	41	14			280	4000
CX03FW12A	5	3/16"	-03	M12x1,5	16	41	15			280	4000
CX04FW10C	6,3	1/4"	-04	M10x1	17	45	17			280	4000
CX04FW12A	6,3	1/4"	-04	M12x1,5	16,5	44,5	15			280	4000
CX04FW14A	6,3	1/4"	-04	M14x1,5	18,5	46,5	17			280	4000
CX04FW16A	6,3	1/4"	-04	M16x1,5	18,5	46,5	19			280	4000
CX04FW18A	6,3	1/4"	-04	M18x1,5	21,5	49,5	22			280	4000
CX05FW14A	8	5/16"	-05	M14x1,5	19	47	17			280	4000
CX05FW16A	8	5/16"	-05	M16x1,5	18	46	19			280	4000
CX05FW18A	8	5/16"	-05	M18x1,5	21,5	49,5	22			280	4000
CX06FW14A	10	3/8"	-06	M14x1,5	19,5	50	17			280	4000
CX06FW16A	10	3/8"	-06	M16x1,5	18,5	49	19			280	4000
CX06FW18A	10	3/8"	-06	M18x1,5	20,5	51	22			280	4000
CX06FW20A	10	3/8"	-06	M20x1,5	20,5	51	24			280	4000
CX06FW22A	10	3/8"	-06	M22x1,5	23	53,5	27			280	4000
CX08FW18A	12,5	1/2"	-08	M18x1,5	22,5	55,5	22			280	4000
CX08FW20A	12,5	1/2"	-08	M20x1,5	21,5	54,5	24			280	4000
CX08FW22A	12,5	1/2"	-08	M22x1,5	23	56	27			280	4000
CX08FW24A	12,5	1/2"	-08	M24x1,5	23,5	56,5	30			280	4000
CX08FW26A	12,5	1/2"	-08	M26x1,5	27	60	32			280	4000
CX10FW22A	16	5/8"	-10	M22x1,5	24	60	27			280	4000
CX10FW24A	16	5/8"	-10	M24x1,5	22,5	58,5	30			280	4000
CX10FW26A	16	5/8"	-10	M26x1,5	27	63	32			280	4000
CX10FW27A	16	5/8"	-10	M27x1,5	22	63	32			280	4000
CX12FW26A	19	3/4"	-12	M26x1,5	26,5	67	32			280	4000
CX12FW27A	19	3/4"	-12	M27x1,5	26,5	67	32			280	4000
CX12FW30A	19	3/4"	-12	M30x1,5	27	67,5	36			210	1500
CX16FW38A	25	1"	-16	M38x1,5	31	82	46			165	2400
CX20FW45A	31,5	1 1/4"	-20	M45x1,5	32	89,5	50			125	1800
CX24FW52A	38	1 1/2"	-24	M52x1,5	33,5	98	60			90	1300

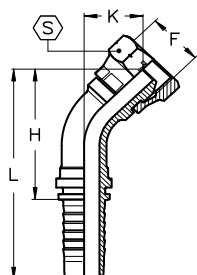
FW45
METRIC FEMALE 60° CONE - 45° ELBOW - CRIMPED BACK NUT
FEMMINA METRICA OGIVA 60° - CURVA A 45° - DADO PRESSATO
DKM45

TIEFFE Part.N.	Hose Size			METRIC 60° Connection F	Dimensions (mm)					Maximum W.P.	
	DN	Inch	Dash		H	L	K	S	bar	PSI	
CX03FW10C45	5	3/16"	-03	M10x1	33	58	14	14		280	4000
CX03FW12A45	5	3/16"	-03	M12x1,5	33,5	58,5	14,5	15		280	4000
CX04FW10C45	6,3	1/4"	-04	M10x1	36	64	15,5	17		280	4000
CX04FW12A45	6,3	1/4"	-04	M12x1,5	35	63	14,5	15		280	4000
CX04FW14A45	6,3	1/4"	-04	M14x1,5	37	65	16	17		280	4000
CX04FW16A45	6,3	1/4"	-04	M16x1,5	37	65	16	19		280	4000
CX04FW18A45	6,3	1/4"	-04	M18x1,5	40	68	19	22		280	4000
CX05FW14A45	8	5/16"	-05	M14x1,5	39	67	18	17		280	4000
CX05FW16A45	8	5/16"	-05	M16x1,5	38	66	16	19		280	4000
CX05FW18A45	8	5/16"	-05	M18x1,5	41	69	19	22		280	4000
CX06FW14A45	10	3/8"	-06	M14x1,5	41	72	18	17		280	4000
CX06FW16A45	10	3/8"	-06	M16x1,5	39	70	16	19		280	4000
CX06FW18A45	10	3/8"	-06	M18x1,5	42	73	19	22		280	4000
CX06FW20A45	10	3/8"	-06	M20x1,5	42	73	18	24		280	4000
CX06FW22A45	10	3/8"	-06	M22x1,5	44	75	21	27		280	4000
CX08FW18A45	12,5	1/2"	-08	M18x1,5	49	82	22	22		280	4000
CX08FW20A45	12,5	1/2"	-08	M20x1,5	47	80	20	24		280	4000
CX08FW22A45	12,5	1/2"	-08	M22x1,5	49	82	22	27		280	4000
CX08FW24A45	12,5	1/2"	-08	M24x1,5	49	82	22	30		280	4000
CX08FW26A45	12,5	1/2"	-08	M26x1,5	53	86	26	32		280	4000
CX10FW22A45	16	5/8"	-10	M22x1,5	57	93	26	27		280	4000
CX10FW24A45	16	5/8"	-10	M24x1,5	54	90	24	30		280	4000
CX10FW26A45	16	5/8"	-10	M26x1,5	57	93	26	32		280	4000
CX10FW27A45	16	5/8"	-10	M27x1,5	57	93	26	32		280	4000
CX12FW26A45	19	3/4"	-12	M26x1,5	66	106	28	32		280	4000
CX12FW27A45	19	3/4"	-12	M27x1,5	66	106	28	32		280	4000
CX12FW30A45	19	3/4"	-12	M30x1,5	66	107	29	36		210	1500
CX16FW38A45	25	1"	-16	M38x1,5	84	135	35	46		165	2400
CX20FW45A45	31,5	1 1/4"	-20	M45x1,5	97	155	40	50		125	1800
CX24FW52A45	38	1 1/2"	-24	M52x1,5	114	179	46	60		90	1300

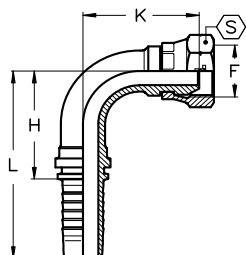
FW90
METRIC FEMALE 60° CONE - 90° ELBOW - CRIMPED BACK NUT
FEMMINA METRICA OGIVA 60° - CURVA A 90° - DADO PRESSATO
DKM90

TIEFFE Part.N.	Hose Size			METRIC 60° Connection F	Dimensions (mm)					Maximum W.P.	
	DN	Inch	Dash		H	L	K	S	bar	PSI	
CX03FW10C90	5	3/16"	-03	M10x1	21	46	23	14		280	4000
CX03FW12A90	5	3/16"	-03	M12x1,5	21	46	24	15		280	4000
CX04FW10C90	6,3	1/4"	-04	M10x1	26	54	28	17		280	4000
CX04FW12A90	6,3	1/4"	-04	M12x1,5	26	54	26	15		280	4000
CX04FW14A90	6,3	1/4"	-04	M14x1,5	26	54	28	17		280	4000
CX04FW16A90	6,3	1/4"	-04	M16x1,5	26	54	29	19		280	4000
CX04FW18A90	6,3	1/4"	-04	M18x1,5	26	54	32	22		280	4000
CX05FW14A90	8	5/16"	-05	M14x1,5	28	56	31	17		280	4000
CX05FW16A90	8	5/16"	-05	M16x1,5	28	56	30	19		280	4000
CX05FW18A90	8	5/16"	-05	M18x1,5	28	56	34	22		280	4000
CX06FW14A90	10	3/8"	-06	M14x1,5	31	61	34	17		280	4000
CX06FW16A90	10	3/8"	-06	M16x1,5	31	61	31	19		280	4000
CX06FW18A90	10	3/8"	-06	M18x1,5	31	61	35	22		280	4000
CX06FW20A90	10	3/8"	-06	M20x1,5	31	61	36	24		280	4000
CX06FW22A90	10	3/8"	-06	M22x1,5	31	61	38	27		280	4000
CX08FW18A90	12,5	1/2"	-08	M18x1,5	37	70	42	22		280	4000
CX08FW20A90	12,5	1/2"	-08	M20x1,5	37	70	40	24		280	4000
CX08FW22A90	12,5	1/2"	-08	M22x1,5	37	70	42	27		280	4000
CX08FW24A90	12,5	1/2"	-08	M24x1,5	37	70	43	30		280	4000
CX08FW26A90	12,5	1/2"	-08	M26x1,5	37	70	48	32		280	4000
CX10FW22A90	16	5/8"	-10	M22x1,5	45	80	50	27		280	4000
CX10FW24A90	16	5/8"	-10	M24x1,5	45	80	46	30		280	4000
CX10FW26A90	16	5/8"	-10	M26x1,5	45	80	50	32		280	4000
CX10FW27A90	16	5/8"	-10	M27x1,5	45	80	50	32		280	4000
CX12FW26A90	19	3/4"	-12	M26x1,5	54	95	56	32		280	4000
CX12FW27A90	19	3/4"	-12	M27x1,5	54	95	56	32		280	4000
CX12FW30A90	19	3/4"	-12	M30x1,5	54	95	57	36		210	1500
CX16FW38A90	25	1"	-16	M38x1,5	70	121	71	46		165	2400
CX20FW45A90	31,5	1 1/4"	-20	M45x1,5	84	142	83	50		125	1800
CX24FW52A90	38	1 1/2"	-24	M52x1,5	100	165	96	60		90	1300

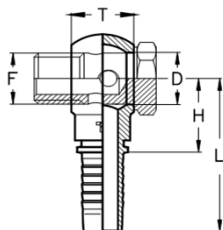
OM
**METRIC BANJO
OCCHIO METRICO**
RNM

TIEFFE Part.N.	Hose Size			Metric BOLT Thread F	Dimensions (mm)					Maximum W.P.		
	DN	Inch	Dash		H	L	D	T		bar	PSI	
CX0302OG*	5	3/16"	-03	M10x1	20	45	10,2	10			200	2900
CX0312OM	5	3/16"	-03	M12x1,5	21,1	46,1	12,1	12			200	2900
CX0314OM	5	3/16"	-03	M14x1,5	22,6	47,6	14,2	14			200	2900
CX0402OG*	6,3	1/4"	-04	M10x1	23	51	10,2	10			200	2900
CX0412OM	6,3	1/4"	-04	M12x1,5	23	51	12,1	12			200	2900
CX0414OM	6,3	1/4"	-04	M14x1,5	23	51	14,2	14			200	2900
CX0416OM	6,3	1/4"	-04	M16x1,5	26,5	54,5	16,2	17,5			200	2900
CX0418OM	6,3	1/4"	-04	M18x1,5	28,5	56,5	18,2	20,5			200	2900
CX0512OM	8	5/16"	-05	M12x1,5	23,5	51,5	12,1	12			200	2900
CX0514OM	8	5/16"	-05	M14x1,5	24	52	14,2	14			200	2900
CX0516OM	8	5/16"	-05	M16x1,5	26,5	54,5	16,2	17,5			200	2900
CX0518OM	8	5/16"	-05	M18x1,5	28,5	56,5	18,2	20,5			200	2900
CX0614OM	10	3/8"	-06	M14x1,5	24	54,5	14,2	14			200	2900
CX0616OM	10	3/8"	-06	M16x1,5	24	54,5	16,2	17,5			200	2900
CX0618OM	10	3/8"	-06	M18x1,5	27	57,5	18,2	20,5			200	2900
CX0620OM	10	3/8"	-06	M20x1,5	32	62,5	20,2	23			200	2900
CX0622OM	10	3/8"	-06	M22x1,5	32	62,5	22,2	22,5			200	2900
CX0812OG*	12,5	1/2"	-08	M26x1,5	39	72	26,5	29,5			200	2900
CX0818OM	12,5	1/2"	-08	M18x1,5	28,1	61,1	18,2	20,5			200	2900
CX0820OM	12,5	1/2"	-08	M20x1,5	28,5	61,5	20,2	23			200	2900
CX0822OM	12,5	1/2"	-08	M22x1,5	28,5	61,5	22,2	22,5			200	2900
CX1012OG*	16	5/8"	-10	M26x1,5	34,7	70,5	26,5	29,5			200	2900
CX1022OM	16	5/8"	-10	M22x1,5	27,2	63	22,2	22,5			200	2900
CX1212OG*	19	3/4"	-12	M26x1,5	37,5	78	26,5	29,5			200	2900
CX1230OM	19	3/4"	-16	M30x1,5	41,5	82	30,2	36			200	2900
CX1630OM	25	1"	-20	M30x1,5	43	94	30,2	36			200	2900

* BSP BANJO

* OCCHIO GAS

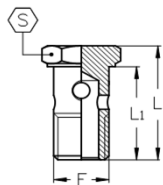
06VS
**METRIC BANJO BOLT
VITE FORATA METRICA**

TIEFFE Part.N.				Metric BOLT Thread F	Dimensions (mm)						
					L	L1	S				
06VS10C				M10x1	26	21,5	14				
06VS12A				M12x1,5	31	25,5	17				
06VS14A				M14x1,5	37,5	30,5	19				
06VS16A				M16x1,5	40	32,5	22				
06VS18A				M18x1,5	44	36,5	24				
06VS20A				M20x1,5	48	39,5	27				
06VS22A				M22x1,5	50	41,5	27				
06VS26A				M26x1,5	58	48,5	32				
06VS30A				M30x1,5	64	53	36				

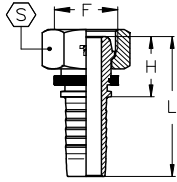
FM
METRIC FEMALE MULTISEAL - SLIP-ON NUT
FEMMINA METRICA MULTISEAL - DADO LIBERO
DKL

TIEFFE Part.N.	Hose Size			METRIC Connection		Dimensions (mm)					Maximum W.P.	
	DN	Inch	Dash	F	Pipe	H	L	S			bar	PSI
CX04FM8L	6,3	1/4"	-04	M14x1,5	8L	20	48	17			280	4000
CX05FM10L	8	5/16"	-05	M16x1,5	10L	20	48	19			280	4000
CX06FM12L	10	3/8"	-06	M18x1,5	12L	20	50	22			280	4000
CX08FM15L	12,5	1/2"	-08	M22x1,5	15L	21	54	27			280	4000
CX10FM18L	16	5/8"	-10	M26x1,5	18L	23	58	32			210	3000

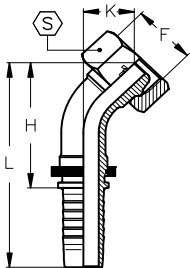
FM45
METRIC FEMALE MULTISEAL - 45° ELBOW - SLIP-ON NUT
FEMMINA METRICA MULTISEAL - CURVA A 45° - DADO LIBERO
DKL45

TIEFFE Part.N.	Hose Size			METRIC Connection		Dimensions (mm)					Maximum W.P.	
	DN	Inch	Dash	F	Pipe	H	L	K	S		bar	PSI
CX04FM8L45	6,3	1/4"	-04	M14x1,5	8L	35	63	13	17		280	4000
CX05FM10L45	8	5/16"	-05	M16x1,5	10L	37	65	15	19		280	4000
CX06FM12L45	10	3/8"	-06	M18x1,5	12L	39	69	15	22		280	4000
CX08FM15L45	12,5	1/2"	-08	M22x1,5	15L	45	78	17	27		280	4000
CX10FM18L45	16	5/8"	-10	M26x1,5	18L	52	87	20	32		210	3000

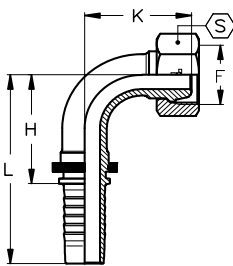
FM90
METRIC FEMALE MULTISEAL - 90° ELBOW - SLIP-ON NUT
FEMMINA METRICA MULTISEAL - CURVA A 90° - DADO LIBERO
DKL90

TIEFFE Part.N.	Hose Size			METRIC Connection		Dimensions (mm)					Maximum W.P.	
	DN	Inch	Dash	F	Pipe	H	L	K	S		bar	PSI
CX04FM8L90	6,3	1/4"	-04	M14x1,5	8L	29	57	27	17		280	4000
CX05FM10L90	8	5/16"	-05	M16x1,5	10L	31	59	30	19		280	4000
CX06FM12L90	10	3/8"	-06	M18x1,5	12L	31	61	30	22		280	4000
CX08FM15L90	12,5	1/2"	-08	M22x1,5	15L	37	70	36	27		280	4000
CX10FM18L90	16	5/8"	-10	M26x1,5	18L	45	81	42	32		210	3000

MM-L
METRIC MALE 24° CONE SEAT - LIGHT DUTY
 MASCHIO METRICO SVASATO 24° - SERIE LEGGERA

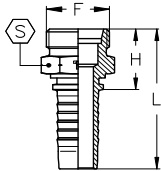
CEL

TIEFFE Part.N.	Hose Size			METRIC 24° Connection		Dimensions (mm)					Maximum W.P.	
	DN	Inch	Dash	F	Pipe	H	L	S			bar	PSI
CX03MM6L	5	3/16"	-03	M12x1,5	6L	21	46	12			280	4000
CX03MM8L	5	3/16"	-03	M14x1,5	8L	21	46	14			280	4000
CX04MM6L	6,3	1/4"	-04	M12x1,5	6L	21	49	12			280	4000
CX04MM8L	6,3	1/4"	-04	M14x1,5	8L	21	49	14			280	4000
CX04MM10L	6,3	1/4"	-04	M16x1,5	10L	23	51	17			280	4000
CX04MM12L	6,3	1/4"	-04	M18x1,5	12L	23	51	19			280	4000
CX05MM10L	8	5/16"	-05	M16x1,5	10L	23	51	17			280	4000
CX05MM12L	8	5/16"	-05	M18x1,5	12L	23	51	19			280	4000
CX06MM10L	10	3/8"	-06	M16x1,5	10L	23	53	17			280	4000
CX06MM12L	10	3/8"	-06	M18x1,5	12L	23	53	19			280	4000
CX06MM15L	10	3/8"	-06	M22x1,5	15L	25	56	22			280	4000
CX08MM15L	12,5	1/2"	-08	M22x1,5	15L	26	59	22			280	4000
CX08MM18L	12,5	1/2"	-08	M26x1,5	18L	28	61	27			210	3000
CX10MM18L	16	5/8"	-10	M26x1,5	18L	28	64	27			210	3000
CX10MM22L	16	5/8"	-10	M30x2	22L	30	66	30			210	3000
CX12MM18L	19	3/4"	-12	M26x1,5	18L	29	70	27			210	3000
CX12MM22L	19	3/4"	-12	M30x2	22L	31	72	30			210	3000
CX16MM28L	25	1"	-16	M36x2	28L	35	86	36			165	2400
CX20MM35L	31,5	1 1/4"	-20	M45x2	35L	40	97	46			100	1450
CX24MM42L	38	1 1/2"	-24	M52x2	42L	42	106	55			100	1450

MM-S
METRIC MALE - 24° CONE SEAT - HEAVY DUTY
 MASCHIO METRICO - SVASATO 24° - SERIE PESANTE

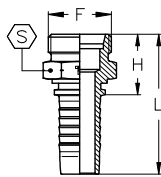
CES

TIEFFE Part.N.	Hose Size			METRIC 24° Connection		Dimensions (mm)					Maximum W.P.	
	DN	Inch	Dash	F	Pipe	H	L	S			bar	PSI
CX03MM6S	5	3/16"	-03	M14x1,5	6S	23	48	14			415	6000
CX03MM8S	5	3/16"	-03	M16x1,5	8S	23	48	17			415	6000
CX04MM6S	6,3	1/4"	-04	M14x1,5	6S	23	51	14			450	6500
CX04MM8S	6,3	1/4"	-04	M16x1,5	8S	23	51	17			450	6500
CX04MM10S	6,3	1/4"	-04	M18x1,5	10S	24	52	19			450	6500
CX04MM12S	6,3	1/4"	-04	M20x1,5	12S	25	53	22			450	6500
CX05MM10S	8	5/16"	-05	M18x1,5	10S	24	52	19			350	5000
CX05MM12S	8	5/16"	-05	M20x1,5	12S	25	53	22			350	5000
CX06MM10S	10	3/8"	-06	M18x1,5	10S	24	55	19			445	6500
CX06MM12S	10	3/8"	-06	M20x1,5	12S	25	56	22			445	6500
CX06MM14S	10	3/8"	-06	M22x1,5	14S	27	58	22			445	6500
CX08MM14S	12,5	1/2"	-08	M22x1,5	14S	28	61	22			415	6000
CX08MM16S	12,5	1/2"	-08	M24x1,5	16S	29	62	24			415	6000
CX10MM20S	16	5/8"	-10	M30x2	20S	32	68	30			350	5000
CX12MM20S	19	3/4"	-12	M30x2	20S	33	74	30			350	5000
CX12MM25S	19	3/4"	-12	M36x2	25S	37	78	36			350	5000
CX16MM25S	25	1"	-16	M36x2	25S	39	90	36			280	4000
CX16MM30S	25	1"	-16	M42x2	30S	43	94	46			280	4000
CX20MM30S	31,5	1 1/4"	-20	M42x2	30S	44	101	46			210	3000
CX20MM38S	31,5	1 1/4"	-20	M52x2	38S	48	105	55			210	3000
CX24MM38S	38	1 1/2"	-24	M52x2	38S	48	112	55			185	2700

FOS-L
METRIC FEMALE 24° O-RING CONE - LIGHT DUTY - SLIP-ON NUT
 FEMMINA METRICA OGIVA 24° O-RING - SERIE LEGGERA - DADO LIBERO

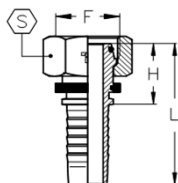
DKOL

TIEFFE Part.N.	Hose Size			METRIC 24° Connection		Dimensions (mm)					Maximum W.P.	
	DN	Inch	Dash	F	Pipe	H	L	S	O-RING	bar	PSI	
CX03FOS6L	5	3/16"	-03	M12x1,5	6L	21	46	14	5x1	280	4000	
CX03FOS8L	5	3/16"	-03	M14x1,5	8L	21	46	17	6x1,5	280	4000	
CX04FOS6L*	6,3	1/4"	-04	M12x1,5	6L	23	51	15	5x1	280	4000	
CX04FOS8L	6,3	1/4"	-04	M14x1,5	8L	22	50	17	6x1,5	280	4000	
CX04FOS10L	6,3	1/4"	-04	M16x1,5	10L	24	52	19	7,5x1,5	280	4000	
CX04FOS12L	6,3	1/4"	-04	M18x1,5	12L	24	52	22	9x1,5	280	4000	
CX05FOS10L	8	5/16"	-05	M16x1,5	10L	24	52	19	7,5x1,5	280	4000	
CX05FOS12L	8	5/16"	-05	M18x1,5	12L	24	52	22	9x1,5	280	4000	
CX06FOS10L*	10	3/8"	-06	M16x1,5	10L	23	54	19	7,5x1,5	280	4000	
CX06FOS12L	10	3/8"	-06	M18x1,5	12L	24	54	22	9x1,5	280	4000	
CX06FOS15L	10	3/8"	-06	M22x1,5	15L	24,5	55	27	12x2	280	4000	
CX08FOS15L	12,5	1/2"	-08	M22x1,5	15L	25	58	27	12x2	280	4000	
CX08FOS18L	12,5	1/2"	-08	M26x1,5	18L	26	59	32	15x2	210	3000	
CX10FOS18L	16	5/8"	-10	M26x1,5	18L	27	62	32	15x2	210	3000	
CX10FOS22L	16	5/8"	-10	M30x2	22L	28	64	36	20x2	210	3000	
CX12FOS18LP*	19	3/4"	-12	M26x1,5	18L	34	75	32	15x2	210	3000	
CX12FOS22L	19	3/4"	-12	M30x2	22L	31	71	36	20x2	210	3000	
CX16FOS28L	25	1"	-16	M36x2	28L	32	83	41	26x2	165	2400	
CX20FOS35L	31,5	1 1/4"	-20	M45x2	35L	36	94	50	32x2,5	100	1450	
CX24FOS42L	38	1 1/2"	-24	M52x2	42L	37	102	60	38x2,5	100	1450	

* Crimped-back nut

* Dado pressato

FOS-S
METRIC FEMALE 24° O-RING CONE - HEAVY DUTY - SLIP-ON NUT
 FEMMINA METRICA OGIVA 24° O-RING - SERIE PESANTE - DADO LIBERO

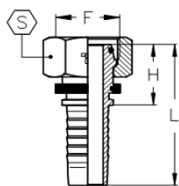
DKOS

TIEFFE Part.N.	Hose Size			METRIC 24° Connection		Dimensions (mm)					Maximum W.P.	
	DN	Inch	Dash	F	Pipe	H	L	S	O-RING	bar	PSI	
CX03FOS6S	5	3/16"	-03	M14x1,5	6S	21	46	17	5x1	415	6000	
CX03FOS8S	5	3/16"	-03	M16x1,5	8S	21	46	19	6x1,5	415	6000	
CX04FOS6S*	6,3	1/4"	-04	M14x1,5	6S	23	51	17	5x1	450	6500	
CX04FOS8S	6,3	1/4"	-04	M16x1,5	8S	22	50	19	6x1,5	450	6500	
CX04FOS10S	6,3	1/4"	-04	M18x1,5	10S	24	52	22	7,5x1,5	450	6500	
CX04FOS12S	6,3	1/4"	-04	M20x1,5	12S	24	52	24	9x1,5	450	6500	
CX05FOS10S	8	5/16"	-05	M18x1,5	10S	24	52	22	7,5x1,5	350	5000	
CX05FOS12S	8	5/16"	-05	M20x1,5	12S	24	52	24	9x1,5	350	5000	
CX06FOS10S*	10	3/8"	-06	M18x1,5	10S	25	55	22	7,5x1,5	445	6500	
CX06FOS12S	10	3/8"	-06	M20x1,5	12S	24	54	24	9x1,5	445	6500	
CX06FOS14S	10	3/8"	-06	M22x1,5	14S	28	58	27	10x2	445	6500	
CX08FOS14S	12,5	1/2"	-08	M22x1,5	14S	28	61	27	10x2	415	6000	
CX08FOS16S	12,5	1/2"	-08	M24x1,5	16S	29	62	30	12x2	415	6000	
CX10FOS20S	16	5/8"	-10	M30x2	20S	33	69	36	16,3x2,4	350	5000	
CX12FOS20S	19	3/4"	-12	M30x2	20S	36	76	36	16,3x2,4	350	5000	
CX12FOS25S	19	3/4"	-12	M36x2	25S	38	78	46	20,3x2,4	350	5000	
CX12FOS25SE41	19	3/4"	-12	M36x2	25S	38	78	41	20,3x2,4	350	5000	
CX16FOS25S	25	1"	-16	M36x2	25S	40	91	46	22x2	280	4000	
CX16FOS30S	25	1"	-16	M42x2	30S	40	91	50	25,3x2,4	280	4000	
CX20FOS30S	31,5	1 1/4"	-20	M42x2	30S	41	99	50	25,3x2,4	210	3000	
CX20FOS38S	31,5	1 1/4"	-20	M52x2	38S	45	103	60	33,3x2,4	210	3000	
CX24FOS38S	38	1 1/2"	-24	M52x2	38S	46	110	60	33,3x2,4	185	2700	

* Crimped-back nut

* Dado pressato

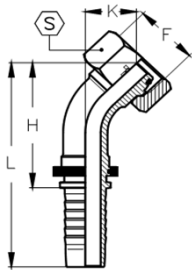
FOS-L45
METRIC FEMALE 24° O'RING CONE - 45° ELBOW - LIGHT DUTY - SLIP-ON NUT
FEMMINA METRICA OGIVA 24° O'RING - CURVA A 45° - SERIE LEGGERA - DADO LIBERO
DKOL45

TIEFFE Part.N.	Hose Size			METRIC 24° Connection		Dimensions (mm)					Maximum W.P.	
	DN	Inch	Dash	F	Pipe	H	L	K	S	O-RING	bar	PSI
CX03FOS6L45	5	3/16"	-03	M12x1,5	6L	34	59	14	14	5x1	280	4000
CX03FOS8L45	5	3/16"	-03	M14x1,5	8L	35	60	14	17	6x1,5	280	4000
CX04FOS6L45*	6,3	1/4"	-04	M12x1,5	6L	35	63	14	15	5x1	280	4000
CX04FOS8L45	6,3	1/4"	-04	M14x1,5	8L	36	64	14	17	6x1,5	280	4000
CX04FOS10L45	6,3	1/4"	-04	M16x1,5	10L	38	66	16	19	7,5x1,5	280	4000
CX04FOS12L45	6,3	1/4"	-04	M18x1,5	12L	39	67	17	22	9x1,5	280	4000
CX05FOS10L45	8	5/16"	-05	M16x1,5	10L	39	67	17	19	7,5x1,5	280	4000
CX05FOS12L45	8	5/16"	-05	M18x1,5	12L	39	67	18	22	9x1,5	280	4000
CX06FOS10L45*	10	3/8"	-06	M16x1,5	10L	39	69	16	19	7,5x1,5	280	4000
CX06FOS12L45	10	3/8"	-06	M18x1,5	12L	40	71	18	22	9x1,5	280	4000
CX06FOS15L45	10	3/8"	-06	M22x1,5	15L	42	72	19	27	12x2	280	4000
CX08FOS15L45	12,5	1/2"	-08	M22x1,5	15L	46	79	19	27	12x2	280	4000
CX08FOS18L45	12,5	1/2"	-08	M26x1,5	18L	47	80	21	32	15x2	210	3000
CX10FOS18L45	16	5/8"	-10	M26x1,5	18L	53	89	22	32	15x2	210	3000
CX10FOS22L45	16	5/8"	-10	M30x2	22L	54	90	23	36	20x2	210	3000
CX12FOS18LP45*	19	3/4"	-12	M26x1,5	18L	66	107	29	32	15x2	210	3000
CX12FOS22L45	19	3/4"	-12	M30x2	22L	62	103	25	36	20x2	210	3000
CX16FOS28L45	25	1"	-16	M36x2	28L	80	131	31	41	26x2	165	2400
CX20FOS35L45	31,5	1 1/4"	-20	M45x2	35L	96	154	40	50	32x2,5	100	1450
CX24FOS42L45	38	1 1/2"	-24	M52x2	42L	115	179	48	60	38x2,5	100	1450

* Crimped-back nut

* Dado pressato

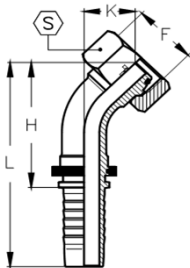
FOS-S45
METRIC FEMALE 24° O'RING CONE - 45° ELBOW - HEAVY DUTY - SLIP-ON NUT
FEMMINA METRICA OGIVA 24° O'RING - CURVA A 45° - SERIE PESANTE - DADO LIBERO
DKOS45

TIEFFE Part.N.	Hose Size			METRIC 24° Connection		Dimensions (mm)					Maximum W.P.	
	DN	Inch	Dash	F	Pipe	H	L	K	S	O-RING	bar	PSI
CX03FOS6S45	5	3/16"	-03	M14x1,5	6S	34	59	14	17	5x1	415	6000
CX03FOS8S45	5	3/16"	-03	M16x1,5	8S	35	60	14	19	6x1,5	415	6000
CX04FOS6S45*	6,3	1/4"	-04	M14x1,5	6S	35	63	14	17	5x1	450	6500
CX04FOS8S45	6,3	1/4"	-04	M16x1,5	8S	36	64	14	19	6x1,5	450	6500
CX04FOS10S45	6,3	1/4"	-04	M18x1,5	10S	38	66	16	22	7,5x1,5	450	6500
CX04FOS12S45	6,3	1/4"	-04	M20x1,5	12S	39	67	17	24	9x1,5	450	6500
CX05FOS10S45	8	5/16"	-05	M18x1,5	10S	39	67	17	22	7,5x1,5	350	5000
CX05FOS12S45	8	5/16"	-05	M20x1,5	12S	39	67	18	24	9x1,5	350	5000
CX06FOS10S45*	10	3/8"	-06	M18x1,5	10S	40	70	17	22	7,5x1,5	445	6500
CX06FOS12S45	10	3/8"	-06	M20x1,5	12S	40	71	18	24	9x1,5	445	6500
CX06FOS14S45	10	3/8"	-06	M22x1,5	14S	42	72	19	27	10x2	445	6500
CX08FOS14S45	12,5	1/2"	-08	M22x1,5	14S	46	79	20	27	10x2	415	6000
CX08FOS16S45	12,5	1/2"	-08	M24x1,5	16S	47	80	21	30	12x2	415	6000
CX10FOS20S45	16	5/8"	-10	M30x2	20S	56	92	25	36	16,3x2,4	350	5000
CX12FOS20S45	19	3/4"	-12	M30x2	20S	64	105	27	36	16,3x2,4	350	5000
CX12FOS25S45	19	3/4"	-12	M36x2	25S	64	105	28	46	20,3x2,4	350	5000
CX12FOS25S45E41	19	3/4"	-12	M36x2	25S	64	105	28	41	20,3x2,4	350	5000
CX16FOS25S45	25	1"	-16	M36x2	25S	82	133	34	41	22x2	280	4000
CX16FOS30S45	25	1"	-16	M42x2	30S	80	131	31	50	25,3x2,4	280	4000
CX20FOS30S45	31,5	1 1/4"	-20	M42x2	30S	96	154	41	50	25,3x2,4	210	3000
CX20FOS38S45	31,5	1 1/4"	-20	M52x2	38S	94	152	38	60	33,3x2,4	210	3000
CX24FOS38S45	38	1 1/2"	-24	M52x2	38S	115	180	49	60	33,3x2,4	185	2700

* Crimped-back nut

* Dado pressato

FOS-L90
METRIC FEMALE 24° O'RING CONE - 90° ELBOW - LIGHT DUTY - SLIP-ON NUT
 FEMMINA METRICA OGIVA 24° O'RING - CURVA A 90° - SERIE LEGGERA - DADO LIBERO

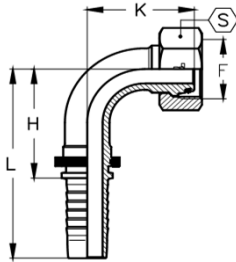
DKOL90

TIEFFE Part.N.	Hose Size			METRIC 24° Connection		Dimensions (mm)					Maximum W.P.	
	DN	Inch	Dash	F	Pipe	H	L	K	S	O-RING	bar	PSI
CX03FOS6L90	5	3/16"	-03	M12x1,5	6L	27	52	28	14	5x1	280	4000
CX03FOS8L90	5	3/16"	-03	M14x1,5	8L	27	52	28	17	6x1,5	280	4000
CX04FOS6L90*	6,3	1/4"	-04	M12x1,5	6L	26	53	26	15	5x1	280	4000
CX04FOS8L90	6,3	1/4"	-04	M14x1,5	8L	29	57	29	17	6x1,5	280	4000
CX04FOS10L90	6,3	1/4"	-04	M16x1,5	10L	29	57	30	19	7,5x1,5	280	4000
CX04FOS12L90	6,3	1/4"	-04	M18x1,5	12L	29	57	32	22	9x1,5	280	4000
CX05FOS10L90	8	5/16"	-05	M16x1,5	10L	31	59	33	19	7,5x1,5	280	4000
CX05FOS12L90	8	5/16"	-05	M18x1,5	12L	28	56	32	22	9x1,5	280	4000
CX06FOS10L90*	10	3/8"	-06	M16x1,5	10L	31	61	31	19	7,5x1,5	280	4000
CX06FOS12L90	10	3/8"	-06	M18x1,5	12L	31	61	33	22	9x1,5	280	4000
CX06FOS15L90	10	3/8"	-06	M22x1,5	15L	31	61	35	27	12x2	280	4000
CX08FOS15L90	12,5	1/2"	-08	M22x1,5	15L	37	70	38	27	12x2	280	4000
CX08FOS18L90	12,5	1/2"	-08	M26x1,5	18L	37	70	40	32	15x2	210	3000
CX10FOS18L90	16	5/8"	-10	M26x1,5	18L	44	80	45	32	15x2	210	3000
CX10FOS22L90	16	5/8"	-10	M30x2	22L	44	80	47	36	20x2	210	3000
CX12FOS18LP90*	19	3/4"	-12	M26x1,5	18L	54	94	57	32	15x2	210	3000
CX12FOS22L90	19	3/4"	-12	M30x2	22L	54	94	52	36	20x2	210	3000
CX16FOS28L90	25	1"	-16	M36x2	28L	70	121	66	41	26x2	165	2400
CX20FOS35L90	31,5	1 1/4"	-20	M45x2	35L	84	141	83	50	32x2,5	100	1450
CX24FOS42L90	38	1 1/2"	-24	M52x2	42L	100	164	100	60	38x2,5	100	1450

* Crimped-back nut

* Dado pressato

FOS-S90
METRIC FEMALE 24° O'RING CONE - 90° ELBOW - HEAVY DUTY - SLIP-ON NUT
 FEMMINA METRICA OGIVA 24° O'RING - CURVA A 90° - SERIE PESANTE - DADO LIBERO

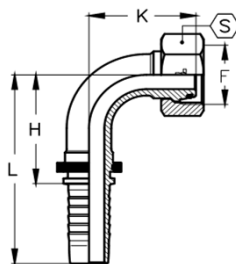
DKOS90

TIEFFE Part.N.	Hose Size			METRIC 24° Connection		Dimensions (mm)					Maximum W.P.	
	DN	Inch	Dash	F	Pipe	H	L	K	S	O-RING	bar	PSI
CX03FOS6S90	5	3/16"	-03	M14x1,5	6S	27	52	28	17	5x1	415	6000
CX03FOS8S90	5	3/16"	-03	M16x1,5	8S	27	52	28	19	6x1,5	415	6000
CX04FOS6S90*	6,3	1/4"	-04	M14x1,5	6S	25	53	26	17	5x1	450	6500
CX04FOS8S90	6,3	1/4"	-04	M16x1,5	8S	29	57	29	19	6x1,5	450	6500
CX04FOS10S90	6,3	1/4"	-04	M18x1,5	10S	29	57	30	22	7,5x1,5	450	6500
CX04FOS12S90	6,3	1/4"	-04	M20x1,5	12S	29	57	32	24	9x1,5	450	6500
CX05FOS10S90	8	5/16"	-05	M18x1,5	10S	31	59	33	22	7,5x1,5	350	5000
CX05FOS12S90	8	5/16"	-05	M20x1,5	12S	28	56	32	24	9x1,5	350	5000
CX06FOS10S90*	10	3/8"	-06	M18x1,5	10S	30	61	33	22	7,5x1,5	445	6500
CX06FOS12S90	10	3/8"	-06	M20x1,5	12S	31	61	33	24	9x1,5	445	6500
CX06FOS14S90	10	3/8"	-06	M22x1,5	14S	34	64	37	27	10x2	445	6500
CX08FOS14S90	12,5	1/2"	-08	M22x1,5	14S	39	71	41	27	10x2	415	6000
CX08FOS16S90	12,5	1/2"	-08	M24x1,5	16S	39	71	42	30	12x2	415	6000
CX10FOS20S90	16	5/8"	-10	M30x2	20S	44	80	49	36	16,3x2,4	350	5000
CX12FOS20S90	19	3/4"	-12	M30x2	20S	54	94	55	36	16,3x2,4	350	5000
CX12FOS25S90	19	3/4"	-12	M36x2	25S	54	94	57	46	20,3x2,4	350	5000
CX12FOS25S90E41	19	3/4"	-12	M36x2	25S	54	94	57	41	20,3x2,4	350	5000
CX16FOS25S90	25	1"	-16	M36x2	25S	70	121	70	46	22x2	280	4000
CX16FOS30S90	25	1"	-16	M42x2	30S	70	121	66	50	25,3x2,4	280	4000
CX20FOS30S90	31,5	1 1/4"	-20	M42x2	30S	84	141	84	50	25,3x2,4	210	3000
CX20FOS38S90	31,5	1 1/4"	-20	M52x2	38S	84	141	80	60	33,3x2,4	210	3000
CX24FOS38S90	38	1 1/2"	-24	M52x2	38S	100	164	101	60	33,3x2,4	185	2700

* Crimped-back nut

* Dado pressato

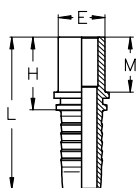
ET
METRIC STANDPIPE - LIGHT/HEAVY DUTY
ESTREMITA' TUBOLARE METRICA - SERIE LEGGERA/PESANTE
**BEL
BES**

TIEFFE Part.N.	Hose Size			Metric PIPE Connection		Dimensions (mm)					Maximum W.P.	
	DN	Inch	Dash	E	Duty	H	L	M			bar	PSI
CX0306ET	5	3/16"	-03	6	L/S	27	52	21			415	6000
CX0308ET	5	3/16"	-03	8	L/S	29	54	23			415	6000
CX0310ET	5	3/16"	-03	10	L/S	31,5	56,5	25			415	6000
CX0406ET	6,3	1/4"	-04	6	L	27,5	55,5	21			280	4000
CX0408ET	6,3	1/4"	-04	8	L/S	29,5	57,5	23			450	6500
CX0410ET	6,3	1/4"	-04	10	L/S	31,5	59,5	25			450	6500
CX0412ET	6,3	1/4"	-04	12	L/S	32	60	25			450	6500
CX0508ET	8	5/16"	-05	8	L/S	30	58	23			350	5000
CX0510ET	8	5/16"	-05	10	L/S	31,5	59,5	25			350	5000
CX0512ET	8	5/16"	-05	12	L/S	31,5	59,5	25			350	5000
CX0608ET	10	3/8"	-06	8	L/S	29,5	60	23			445	6500
CX0610ET	10	3/8"	-06	10	L	28,5	59	22			350	5000
CX0612ET	10	3/8"	-06	12	L/S	31,5	62	25			445	6500
CX0614ET	10	3/8"	-06	14	S	34,5	65	28			445	6500
CX0615ET	10	3/8"	-06	15	L	30,5	61	24			280	4000
CX0616ET	10	3/8"	-06	16	S	36	66,5	29			445	6500
CX0812ET	12,5	1/2"	-08	12	L/S	32,5	65,5	25			415	6000
CX0814ET	12,5	1/2"	-08	14	S	35,5	68,5	28			415	6000
CX0815ET	12,5	1/2"	-08	15	L	31,5	64,5	24			280	4000
CX0816ET	12,5	1/2"	-08	16	S	36,5	69,5	29			415	6000
CX0818ET	12,5	1/2"	-08	18	L	33,5	66,5	26			210	3000
CX1016ET	16	5/8"	-10	16	S	36,5	72,5	29			350	5000
CX1018ET	16	5/8"	-10	18	L	33,5	69,5	26			210	3000
CX1020ET	16	5/8"	-10	20	S	42,5	78,5	35			350	5000
CX1022ET	16	5/8"	-10	22	L	35,5	71,5	28			210	3000
CX1218ET	19	3/4"	-12	18	L	35	75,5	26			210	3000
CX1220ET	19	3/4"	-12	20	S	44	84,5	35			350	5000
CX1222ET	19	3/4"	-12	22	L	37	77,5	28			210	3000
CX1225ET	19	3/4"	-12	25	S	48	88,5	39			350	5000
CX1625ET	25	1"	-16	25	S	49,5	100,5	39			280	4000
CX1628ET	25	1"	-16	28	L	39,5	90,5	29			165	2400
CX1630ET	25	1"	-16	30	S	53,5	104,5	43			280	4000
CX2030ET	31,5	1 1/4"	-20	30	S	54	111,5	43			210	3000
CX2035ET	31,5	1 1/4"	-20	35	L	46	103,5	35			125	1800
CX2038ET	31,5	1 1/4"	-20	38	S	59	116,5	48			210	3000
CX2438ET	38	1 1/2"	-24	38	S	59,5	124	48			185	2700
CX2442ET	38	1 1/2"	-24	42	L	47,5	112	36			100	1450

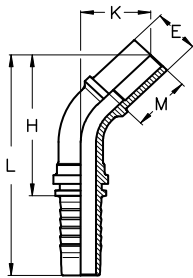
ET45
METRIC STANDPIPE - 45° ELBOW - LIGHT/HEAVY DUTY
ESTREMITA' TUBOLARE METRICA - CURVA A45° - SERIE LEGGERA/PESANTE
BEL45
BES45

TIEFFE Part.N.	Hose Size			Metric PIPE Connection		Dimensions (mm)						Maximum W.P.	
	DN	Inch	Dash	E (mm)	Duty	H	L	K	M			bar	PSI
CX0306ET45	5	3/16"	-03	6	L/S	40	65	21	21			415	6000
CX0308ET45	5	3/16"	-03	8	L/S	41	66	22	23			415	6000
CX0406ET45	6,3	1/4"	-04	6	L	44	72	24	21			280	4000
CX0408ET45	6,3	1/4"	-04	8	L/S	44	72	24	23			450	6500
CX0410ET45	6,3	1/4"	-04	10	L/S	46	74	25	25			450	6500
CX0412ET45	6,3	1/4"	-04	12	L/S	47	75	26	25			450	6500
CX0510ET45	8	5/16"	-05	10	L/S	48	76	26	25			350	5000
CX0512ET45	8	5/16"	-05	12	L/S	48	76	26	25			350	5000
CX0610ET45	10	3/8"	-06	10	L	49	80	26	22			350	5000
CX0612ET45	10	3/8"	-06	12	L/S	50	80	27	25			445	6500
CX0614ET45	10	3/8"	-06	14	S	52	82	29	28			445	6500
CX0615ET45	10	3/8"	-06	15	L	49	80	26	24			280	4000
CX0812ET45	12,5	1/2"	-08	12	S	57	90	30	25			415	6000
CX0814ET45	12,5	1/2"	-08	14	S	58	91	31	28			415	6000
CX0815ET45	12,5	1/2"	-08	15	L	55	88	28	24			280	4000
CX0816ET45	12,5	1/2"	-08	16	S	58	91	32	29			415	6000
CX0818ET45	12,5	1/2"	-08	18	L	56	89	30	26			210	3000
CX1016ET45	16	5/8"	-10	16	S	64	100	33	29			350	5000
CX1018ET45	16	5/8"	-10	18	L	62	98	31	26			210	3000
CX1020ET45	16	5/8"	-10	20	S	68	104	37	35			350	5000
CX1022ET45	16	5/8"	-10	22	L	61	97	30	28			210	3000
CX1218ET45	19	3/4"	-12	18	L	76	116	38	26			210	3000
CX1220ET45	19	3/4"	-12	20	S	76	117	39	35			350	5000
CX1222ET45	19	3/4"	-12	22	L	71	112	34	28			210	3000
CX1225ET45	19	3/4"	-12	25	S	79	119	41	39			350	5000
CX1625ET45	25	1"	-16	25	S	101	152	52	39			280	4000
CX1628ET45	25	1"	-16	28	L	94	145	45	29			165	2400
CX1630ET45	25	1"	-16	30	S	97	148	48	43			280	4000
CX2030ET45	31,5	1 1/4"	-20	30	S	112	170	55	43			210	3000
CX2035ET45	31,5	1 1/4"	-20	35	L	110	168	53	35			125	1800
CX2038ET45	31,5	1 1/4"	-20	38	S	113	171	56	48			210	3000
CX2438ET45	38	1 1/2"	-24	38	S	133	197	65	48			185	2700
CX2442ET45	38	1 1/2"	-24	42	L	124	189	56	36			100	1450

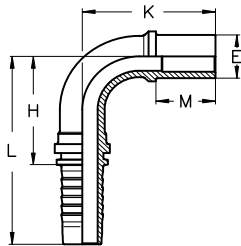
ET90
METRIC STANDPIPE - 90° ELBOW - LIGHT/HEAVY DUTY
ESTREMITA' TUBOLARE METRICA - CURVA A 90° - SERIE LEGGERA/PESANTE
BEL90
BES90

TIEFFE Part.N.	Hose Size			Metric PIPE Connection		Dimensions (mm)					Maximum W.P.	
	DN	Inch	Dash	E (mm)	Duty	H	L	K	M		bar	PSI
CX0306ET90	5	3/16"	-03	6	L/S	21	46	34	21		415	6000
CX0308ET90	5	3/16"	-03	8	L/S	21	46	36	23		415	6000
CX0406ET90	6,3	1/4"	-04	6	L	26	54	39	21		280	4000
CX0408ET90	6,3	1/4"	-04	8	L/S	26	54	39	23		450	6500
CX0410ET90	6,3	1/4"	-04	10	L/S	26	54	41	25		450	6500
CX0412ET90	6,3	1/4"	-04	12	L/S	26	54	43	25		450	6500
CX0510ET90	8	5/16"	-05	10	L/S	28	56	44	25		350	5000
CX0512ET90	8	5/16"	-05	12	L/S	28	56	44	25		350	5000
CX0610ET90	10	3/8"	-06	10	L	31	61	45	22		350	5000
CX0612ET90	10	3/8"	-06	12	L/S	31	61	46	25		445	6500
CX0614ET90	10	3/8"	-06	14	S	31	61	49	28		445	6500
CX0615ET90	10	3/8"	-06	15	L	31	61	45	24		280	4000
CX0812ET90	12,5	1/2"	-08	12	LS	38	71	54	25		415	6000
CX0814ET90	12,5	1/2"	-08	14	S	38	71	55	28		415	6000
CX0815ET90	12,5	1/2"	-08	15	L	38	71	51	24		280	4000
CX0816ET90	12,5	1/2"	-08	16	S	38	71	56	29		415	6000
CX0818ET90	12,5	1/2"	-08	18	L	38	71	53	26		210	3000
CX1016ET90	16	5/8"	-10	16	S	45	80	60	29		350	5000
CX1018ET90	16	5/8"	-10	18	L	45	80	57	26		210	3000
CX1020ET90	16	5/8"	-10	20	S	45	80	66	35		350	5000
CX1022ET90	16	5/8"	-10	22	L	45	80	56	28		210	3000
CX1218ET90	19	3/4"	-12	18	L	54	95	70	26		210	3000
CX1220ET90	19	3/4"	-12	20	S	54	95	70	35		350	5000
CX1222ET90	19	3/4"	-12	22	L	54	95	64	28		210	3000
CX1225ET90	19	3/4"	-12	25	S	54	95	75	39		350	5000
CX1625ET90	25	1"	-16	25	S	70	121	96	39		280	4000
CX1628ET90	25	1"	-16	28	L	70	121	86	29		165	2400
CX1630ET90	25	1"	-16	30	S	70	121	90	43		280	4000
CX2030ET90	31,5	1 1/4"	-20	30	S	84	142	103	43		210	3000
CX2035ET90	31,5	1 1/4"	-20	35	L	84	142	100	35		125	1800
CX2038ET90	31,5	1 1/4"	-20	38	S	84	142	105	48		210	3000
CX2438ET90	38	1 1/2"	-24	38	S	100	165	123	48		185	2700
CX2442ET90	38	1 1/2"	-24	42	L	100	165	111	36		100	1450

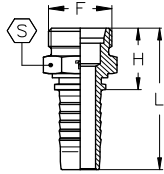
MF
METRIC MALE 24° CONE SEAT - FRENCH GAZ TYPE
MASCHIO METRICO SVASATO 24° - TIPO GAZ FRANCESE
AGF

TIEFFE Part.N.	Hose Size			METRIC 24° French Gaz Connection		Dimensions (mm)				Maximum W.P.	
	DN	Inch	Dash	F	Pipe	H	L	S		bar	PSI
CX0413MF	6,3	1/4"	-04	M20x1,5	13,25	25	53	22		400	5800
CX0513MF	8	5/16"	-05	M20x1,5	13,25	25	53	22		350	5000
CX0613MF	10	3/8"	-06	M20x1,5	13,25	25	55,5	22		330	4800
CX0617MF	10	3/8"	-06	M24x1,5	16,75	26	56,5	24		330	4800
CX0817MF	12,5	1/2"	-08	M24x1,5	16,75	27	60	24		280	4000
CX0821MF	12,5	1/2"	-08	M30x1,5	21,25	30	63	30		280	4000
CX1021MF	16	5/8"	-10	M30x1,5	21,25	30	66	30		280	4000
CX1221MF	19	3/4"	-12	M30x1,5	21,25	31	71,5	30		280	4000
CX1227MF	19	3/4"	-12	M36x1,5	26,75	33	73,5	36		210	3000
CX1633MF	25	1"	-16	M45x1,5	33,5	38,5	89,5	46		210	3000
CX2033MF	31,5	1 1/4"	-20	M45x1,5	33,5	39,5	97	46		125	1800

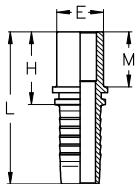
ETF
STANDPIPE - FRENCH GAZ TYPE
ESTREMITA' TUBOLARE - TIPO GAZ FRANCESE
BEF

TIEFFE Part.N.	Hose Size			French Gaz Pipe	Dimensions (mm)				Maximum W.P.	
	DN	Inch	Dash	E	H	L	M		bar	PSI
CX0413ETF	6,3	1/4"	-04	13,25	31	59	24		400	5800
CX0513ETF	8	5/16"	-05	13,25	30,5	58,5	24		350	5000
CX0613ETF	10	3/8"	-06	13,25	30,5	61	24		330	4800
CX0617ETF	10	3/8"	-06	16,75	33	63,5	26		330	4800
CX0817ETF	12,5	1/2"	-08	16,75	33,5	66,5	26		280	4000
CX0821ETF	12,5	1/2"	-08	21,25	36,5	69,5	28		280	4000
CX1021ETF	16	5/8"	-10	21,25	36	71,5	28		280	4000
CX1221ETF	19	3/4"	-12	21,25	37	77,5	28		280	4000
CX1227ETF	19	3/4"	-12	26,75	40,5	81	30		210	3000
CX1633ETF	25	1"	-16	33,5	44	95	32		210	3000
CX2033ETF	31,5	1 1/4"	-20	33,5	43	100,5	32		125	1800

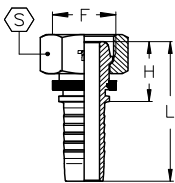
FF
METRIC FEMALE 24° CONE - SLIP-ON NUT - FRENCH GAZ TYPE
FEMMINA METRICA OGIVA 24° - DADO LIBERO - TIPO GAZ FRANCESE
DKF

TIEFFE Part.N.	Hose Size			METRIC 24° French Gaz Connection		Dimensions (mm)				Maximum W.P.	
	DN	Inch	Dash	F	Pipe	H	L	S		bar	PSI
CX0413FF	6,3	1/4"	-04	M20x1,5	13,25	22	50	24		400	5800
CX0513FF	8	5/16"	-05	M20x1,5	13,25	22	50	24		350	5000
CX0613FF	10	3/8"	-06	M20x1,5	13,25	21,5	52	24		330	4800
CX0617FF	10	3/8"	-06	M24x1,5	16,75	25,5	56	30		330	4800
CX0817FF	12,5	1/2"	-08	M24x1,5	16,75	25,5	58,5	30		280	4000
CX0821FF	12,5	1/2"	-08	M30x1,5	21,25	26,5	59,5	36		280	4000
CX1021FF	16	5/8"	-10	M30x1,5	21,25	26,5	62	36		280	4000
CX1221FF	19	3/4"	-12	M30x1,5	21,25	27,5	68	36		280	4000
CX1227FF	19	3/4"	-12	M36x1,5	26,75	29	68,5	41		210	3000
CX1633FF	25	1"	-16	M45x1,5	33,5	31,5	82,5	50		210	3000
CX2033FF	31,5	1 1/4"	-20	M45x1,5	33,5	32	89,5	50		125	1800

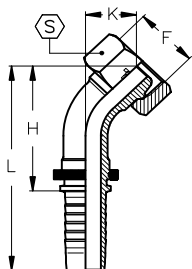
FF45
METRIC FEMALE 24° CONE - 45° ELBOW - SLIP-ON NUT - FRENCH GAZ TYPE
FEMMINA METRICA OGIVA 24° - CURVA A 45° - DADO LIBERO - TIPO GAZ FRANCESE
DKF45

TIEFFE Part.N.	Hose Size			METRIC 24° French Gaz Connection		Dimensions (mm)					Maximum W.P.	
	DN	Inch	Dash	F	Pipe	H	L	K	S	bar	PSI	
CX0413FF45	6,3	1/4"	-04	M20x1,5	13,25	38	66	16	24	400	5800	
CX0513FF45	8	5/16"	-05	M20x1,5	13,25	38,5	66,5	16,5	24	350	5000	
CX0613FF45	10	3/8"	-06	M20x1,5	13,25	39,5	70	16,5	24	330	4800	
CX0617FF45	10	3/8"	-06	M24x1,5	16,75	43	73,5	20	30	330	4800	
CX0817FF45	12,5	1/2"	-08	M24x1,5	16,75	47	80	20,5	30	280	4000	
CX0821FF45	12,5	1/2"	-08	M30x1,5	21,25	48,5	81,5	22	36	280	4000	
CX1021FF45	16	5/8"	-10	M30x1,5	21,25	52,5	88,5	22	36	280	4000	
CX1221FF45	19	3/4"	-12	M30x1,5	21,25	60	100,5	23	36	280	4000	
CX1227FF45	19	3/4"	-12	M36x1,5	26,75	62	103	25	41	210	3000	
CX1633FF45	25	1"	-16	M45x1,5	33,5	78,5	130	30,5	50	210	3000	
CX2033FF45	31,5	1 1/4"	-20	M45x1,5	33,5	94	152	38	50	125	1800	

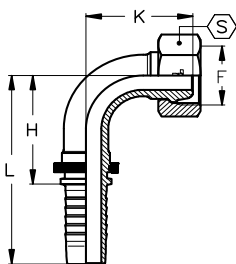
FF90
METRIC FEMALE 24° CONE - 90° ELBOW - SLIP-ON NUT - FRENCH GAZ TYPE
FEMMINA METRICA OGIVA 24° - CURVA A 90° - DADO LIBERO - TIPO GAZ FRANCESE
DKF90

TIEFFE Part.N.	Hose Size			METRIC 24° French Gaz Connection		Dimensions (mm)					Maximum W.P.	
	DN	Inch	Dash	F	Pipe	H	L	K	S	bar	PSI	
CX0413FF90	6,3	1/4"	-04	M20x1,5	13,25	26,5	54,5	29	24	400	5800	
CX0513FF90	8	5/16"	-05	M20x1,5	13,25	28	56	30	24	350	5000	
CX0613FF90	10	3/8"	-06	M20x1,5	13,25	30,5	61	31,5	24	330	4800	
CX0617FF90	10	3/8"	-06	M24x1,5	16,75	30,5	61	37	30	330	4800	
CX0817FF90	12,5	1/2"	-08	M24x1,5	16,75	37	70	40	30	280	4000	
CX0821FF90	12,5	1/2"	-08	M30x1,5	21,25	37	70	42	36	280	4000	
CX1021FF90	16	5/8"	-10	M30x1,5	21,25	44,5	80	44,5	36	280	4000	
CX1221FF90	19	3/4"	-12	M30x1,5	21,25	53,5	94	48,5	36	280	4000	
CX1227FF90	19	3/4"	-12	M36x1,5	26,75	53,5	94	52	41	210	3000	
CX1633FF90	25	1"	-16	M45x1,5	33,5	69,5	120,5	64,5	50	210	3000	
CX2033FF90	31,5	1 1/4"	-20	M45x1,5	33,5	84	141,5	80,5	50	125	1800	

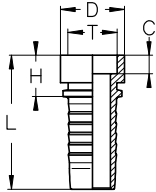
CX--T--
BRAZING STEM
CODOLO A SALDARE

TIEFFE Part.N.	Hose Size			Dimensions (mm)						
	DN	Inch	Dash	H	L	D	T	C		
CX03T06	5	3/16"	-03	11	36	10	6	5		
CX04T08	6,3	1/4"	-04	12,5	40,5	12	8	5,5		
CX05T10	8	5/16"	-05	13	41	14	10	6		
CX06T12	10	3/8"	-06	14	44,5	16	12	6,5		
CX08T14	12,5	1/2"	-08	15,5	48,5	20	14	7		
CX08T15	12,5	1/2"	-08	15,5	48,5	20	15	7		
CX08T16	12,5	1/2"	-08	15,5	48,5	20	16	7		
CX10T18	16	5/8"	-10	16,5	52,5	23	18	7,5		
CX12T20	19	3/4"	-12	18	58,5	26	20	8		
CX12T22	19	3/4"	-12	18	58,5	26	22	8		
CX16T25	25	1"	-16	20,5	71,5	32	25	9		
CX16T28	25	1"	-16	20,5	71,5	32	28	9		
CX20T30	31,5	1 1/4"	-20	22	79,5	40	30	9,5		
CX20T35	31,5	1 1/4"	-20	22	79,5	40	35	9,5		
CX24T38	38	1 1/2"	-24	23	87,5	46	38	10,5		
CX24T42	38	1 1/2"	-24	23	87,5	50	42	10,5		

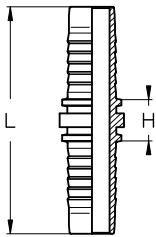
CX-CX
DOUBLE STEM
DOPPIO CODOLO

TIEFFE Part.N.	Hose Size			Dimensions (mm)					Maximum W.P.	
	DN	Inch	Dash	H	L				bar	PSI
CX04CX	6,3	1/4"	-04	13	69				450	6500
CX05CX	8	5/16"	-05	13	69				350	5000
CX06CX	10	3/8"	-06	13	74				445	6500
CX08CX	12,5	1/2"	-08	15	81				415	6000
CX10CX	16	5/8"	-10	16	88				350	5000
CX12CX	19	3/4"	-12	18	99				350	5000
CX16CX	25	1"	-16	21	123				280	4000
CX20CX	31,5	1 1/4"	-20	22	137				210	3000

NO-SKIVE

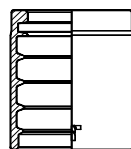

BXC

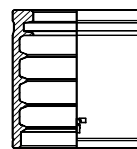

BXT1

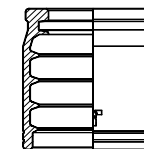

BXT2

NO-SKIVE

RUBBER HOSES STEEL WIRE BRAIDED - TUBI GOMMA TRECCIATI ACCIAIO

Hose Size			ISO 11237 1SC			ISO 11237 2SC						ISO 1436 1SN SAE100 R1AT						ISO 1436 2SN SAE100 R2AT			Collapse control mandrel Spina controllo collasso
			Ferrule Boccola	Skiving length Lungh. di pelatura	Ø Swage (Ref.) Ø Press. (Rif.)	Ferrule Boccola	Skiving length Lungh. di pelatura	Ø Swage (Ref.) Ø Press. (Rif.)	Ferrule Boccola	Skiving length Lungh. di pelatura	Ø Swage (Ref.) Ø Press. (Rif.)	Ferrule Boccola	Skiving length Lungh. di pelatura	Ø Swage (Ref.) Ø Press. (Rif.)	Ferrule Boccola	Skiving length Lungh. di pelatura	Ø Swage (Ref.) Ø Press. (Rif.)	Ferrule Boccola	Skiving length Lungh. di pelatura	Ø Swage (Ref.) Ø Press. (Rif.)	
DN	Inch	Dash	Part.N.	mm	mm	Part.N.	mm	mm	Part.N.	mm	mm	Part.N.	mm	mm	Part.N.	mm	mm	Part.N.	mm	mm	Part.N.
5	3/16"	-03										BXT103	no skive	15,2				BXT203	no skive	15,9	SCP03
6,3	1/4"	-04	BXC04	no-skive	15	BXT104	no-skive	16,1	BXT204	no-skive	16,7	BXT104	no-skive	16,1	BXT204	no-skive	16,7	BXT204	no-skive	18,1	SCP04
8	5/16"	-05	BXC05	no-skive	16,3	BXT105	no-skive	17,9	BXT205	no-skive	18,5	BXT105	no-skive	17,9	BXT205	no-skive	18,5	BXT205	no-skive	19,9	SCP05
10	3/8"	-06	BXC06	no-skive	18,7	BXT106	no-skive	20,1	BXT206	no-skive	20,2	BXT106	no-skive	20,2	BXT206	no-skive	20,3	BXT206	no-skive	21,7	SCP06
12,5	1/2"	-08	BXC08	no-skive	22,2	BXT108	no-skive	23,7	BXT208	no-skive	24	BXT108	no-skive	23,7	BXT208	no-skive	24	BXT208	no-skive	25,4	SCP08
16	5/8"	-10	BXC10	no-skive	25,3	BXT110	no-skive	27,3	BXT210	no-skive	27,8	BXT110	no-skive	27,3	BXT210	no-skive	27,8	BXT210	no-skive	29,3	SCP10
19	3/4"	-12	BXC12	no-skive	29	BXT112	no-skive	31,4	BXT212	no-skive	31,9	BXT112	no-skive	31,3	BXT212	no-skive	31,8	BXT212	no-skive	33,3	SCP12
25	1"	-16	BXC16	no-skive	37	BXT116	no-skive	39,7				BXT116	no-skive	39,6				BXT216	no-skive	42	SCP16
31,5	1 1/4"	-20										BXT120	no-skive	47,9				BXT220	no-skive	53,5	SCP20
38	1 1/2"	-24										BXT124	no-skive	54,7				BXT224	no-skive	59,8	SCP24
51	2"	-32										BXT132	no-skive	68,3				BXT232	no-skive	72,3	SCP32

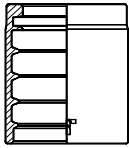
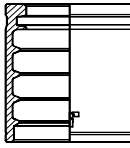
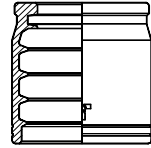
NO-SKIVE				NO-SKIVE
	BXC	BXT1	BXT2	

RUBBER HOSES STEEL WIRE BRAIDED - TUBI GOMMA TRECCIATI ACCIAIO

Hose Size			SAE100 R16			ISO 11237 R16S SAE100 R16S			ISO 11237 R17 SAE100 R17			ISO 11237 R19 SAE100 R19						Collapse control mandrel Spina controllo collasso			
			Ferrule Boccola	Skiving length Lungh. di pelatura	Ø Swage (Ref.) Ø Press. (Rif.)	Ferrule Boccola	Skiving length Lungh. di pelatura	Ø Swage (Ref.) Ø Press. (Rif.)	Ferrule Boccola	Skiving length Lungh. di pelatura	Ø Swage (Ref.) Ø Press. (Rif.)	Ferrule Boccola	Skiving length Lungh. di pelatura	Ø Swage (Ref.) Ø Press. (Rif.)	Ferrule Boccola	Skiving length Lungh. di pelatura	Ø Swage (Ref.) Ø Press. (Rif.)		Ferrule Boccola	Skiving length Lungh. di pelatura	Ø Swage (Ref.) Ø Press. (Rif.)
DN	Inch	Dash	Part.N.	mm	mm	Part.N.	mm	mm	Part.N.	mm	mm	Part.N.	mm	mm	Part.N.	mm	mm	Part.N.	mm	mm	Part.N.
																					SCP03
6,3	1/4"	-04	BXT104	no-skive		BXT104	no-skive		BXC04	no-skive		BXT103	no-skive								SCP04
8	5/16"	-05	BXT105	no-skive		BXT105	no-skive		BXC05	no-skive		BXT104	no-skive								SCP05
10	3/8"	-06	BXT106	no-skive		BXT106	no-skive		BXC06	no-skive		BXT105	no-skive								SCP06
12,5	1/2"	-08	BXT108	no-skive		BXT108	no-skive		BXT108	no-skive		BXT106	no-skive								SCP08
16	5/8"	-10	BXT110	no-skive		BXT110	no-skive		BXT210	no-skive		BXT208	no-skive								SCP10
19	3/4"	-12	BXT112	no-skive		BXT112	no-skive		BXT212	no-skive											SCP12
25	1"	-16	BXT116	no-skive		BXT116	no-skive		BXT216	no-skive											SCP16
31,5	1 1/4"	-20	BXT120	no-skive		BXT120	no-skive														SCP20

For R16 - R17 - R19 and other compact braided hoses applications, contact TIEFFE.

Per applicazioni R16 - R17 - R19 ed altri tubi trecciati compatti, contattare la TIEFFE.

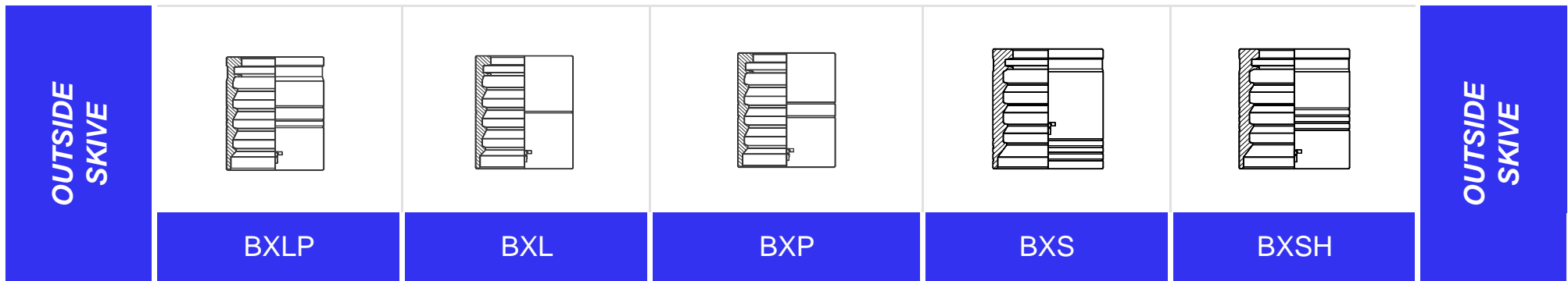

RUBBER HOSES STEEL WIRE BRAIDED - TUBI GOMMA TRECCIATI ACCIAIO

Hose Size			ISO 1436 1SN SAE100 R1AT			ISO 1436 2SN SAE100 R2AT			ISO 11237 2SC			ISO 1436 1SN SAE100 R1AT			ISO 1436 2SN SAE100 R2AT			ISO 1436 2ST SAE100 R2A			Collapse control mandrel Spina controllo collasso
			Ferrule Boccola	Skiving length Lungh. di pelatura	Ø Swage (Ref.) Ø Press. (Rif.)	Ferrule Boccola	Skiving length Lungh. di pelatura	Ø Swage (Ref.) Ø Press. (Rif.)	Ferrule Boccola	Skiving length Lungh. di pelatura	Ø Swage (Ref.) Ø Press. (Rif.)	Ferrule Boccola	Skiving length Lungh. di pelatura	Ø Swage (Ref.) Ø Press. (Rif.)	Ferrule Boccola	Skiving length Lungh. di pelatura	Ø Swage (Ref.) Ø Press. (Rif.)	Ferrule Boccola	Skiving length Lungh. di pelatura	Ø Swage (Ref.) Ø Press. (Rif.)	
DN	Inch	Dash	Part.N.	mm	mm	Part.N.	mm	mm	Part.N.	mm	mm	Part.N.	mm	mm	Part.N.	mm	mm	Part.N.	mm	mm	Part.N.
5	3/16"	-03	BXLP03	18	13,0	BXLP03	18	14,4													SCP03
6,3	1/4"	-04	BXLP04	20	15	BXLP04	20	16,4	BXLP04	20	15,0										SCP04
8	5/16"	-05	BXLP05	20	16,5	BXLP05	20	17,9	BXLP05	20	16,5										SCP05
10	3/8"	-06	BXLP06	23	18,5	BXLP06	23	20	BXLP06	23	18,4							BXS06	22	22,4	SCP06
12,5	1/2"	-08	BXLP08	25	22,3	BXLP08	25	23,7	BXLP08	25	22,3							BXS08	24	25,6	SCP08
16	5/8"	-10	BXLP10	27	26,7	BXLP10	27	28,2	BXLP10	27	26,7							BXS10	27	29,2	SCP10
19	3/4"	-12	BXLP12	31	30,8	BXLP12	31	32,3	BXLP12	31	30,7							BXS12	30	32,7	SCP12
25	1"	-16	BXLP16	34	38,5	BXLP16	34	40	BXLP16	34	38,2							BXS16	38	41,5	SCP16
31,5	1 1/4"	-20										BXL20	39	45,2	BXP20	40	49,6	BXS20	45	50,6	SCP20
38	1 1/2"	-24										BXL24	43	52,7	BXP24	44	57,6	BXS24	50	59,2	SCP24
51	2"	-32										BXL32	58	65,2	BXP32	60	70,5	BXSH32	55	71	SCP32

NO SKIVE

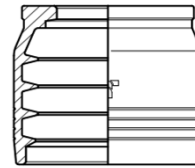

NO SKIVE

BXT4

RUBBER HOSES STEEL WIRE SPIRAL - TUBI GOMMA SPIRALATI ACCIAIO

Hose Size			ISO 3862 4SP			ISO 3862 4SH**			ISO 3862 R12 SAE100 R12									Collapse control mandrel Spina controllo collasso			
			Ferrule Boccola	Skiving length Lungh. di pelatura	Ø Swage (Ref.) Ø Press. (Rif.)	Ferrule Boccola	Skiving length Lungh. di pelatura	Ø Swage (Ref.) Ø Press. (Rif.)	Ferrule Boccola	Skiving length Lungh. di pelatura	Ø Swage (Ref.) Ø Press. (Rif.)	Ferrule Boccola	Skiving length Lungh. di pelatura	Ø Swage (Ref.) Ø Press. (Rif.)	Ferrule Boccola	Skiving length Lungh. di pelatura	Ø Swage (Ref.) Ø Press. (Rif.)		Ferrule Boccola	Skiving length Lungh. di pelatura	Ø Swage (Ref.) Ø Press. (Rif.)
DN	Inch	Dash	Part.N.	mm	mm	Part.N.	mm	mm	Part.N.	mm	mm	Part.N.	mm	mm	Part.N.	mm	mm	Part.N.	mm	mm	Part.N.
19	3/4"	-12	BXT412	no-skive	36	BXT412	no-skive	36,0	BXT412	no-skive	34,6										SCP12
25	1"	-16	BXT416	no-skive	42,5	BXT416	no-skive	41,6	BXT416	no-skive	41										SCP16

** The application of "CX" series hose fittings must be limited to the "ISO 3862 4SP" maximum working pressure.

** L'applicazione dei raccordi per tubo flessibile serie "CX" deve essere limitata alla massima pressione di esercizio del tubo "ISO 3862 4SP".

OUTSIDE
SKIVE

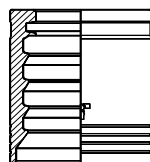

BXS

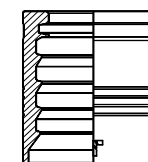

BXSH



OUTSIDE
SKIVE

RUBBER HOSES STEEL WIRE SPIRAL - TUBI GOMMA SPIRALATI ACCIAIO

Hose Size			ISO 3862 4SP			ISO 3862 4SH**			ISO 3862 R12 SAE100 R12									Collapse control mandrel Spina controllo collasso				
			Ferrule Boccola	Skiving length Lungh. di pelatura	Ø Swage (Ref.) Ø Press. (Rif.)	Ferrule Boccola	Skiving length Lungh. di pelatura	Ø Swage (Ref.) Ø Press. (Rif.)	Ferrule Boccola	Skiving length Lungh. di pelatura	Ø Swage (Ref.) Ø Press. (Rif.)	Ferrule Boccola	Skiving length Lungh. di pelatura	Ø Swage (Ref.) Ø Press. (Rif.)	Ferrule Boccola	Skiving length Lungh. di pelatura	Ø Swage (Ref.) Ø Press. (Rif.)		Ferrule Boccola	Skiving length Lungh. di pelatura	Ø Swage (Ref.) Ø Press. (Rif.)	
DN	Inch	Dash	Part.N.	mm	mm	Part.N.	mm	mm	Part.N.	mm	mm	Part.N.	mm	mm	Part.N.	mm	mm	Part.N.	mm	mm	Part.N.	
6,3	1/4"	-04	BXS04	18	19,0																	SCP04
10	3/8"	-06	BXS06	22	23				BXS06	22	22,7											SCP06
12,5	1/2"	-08	BXS08	24	26,7				BXS08	24	26,4											SCP08
16	5/8"	-10	BXS10	27	30,7				BXS10	27	30,6											SCP10
19	3/4"	-12	BXS12	30	34,4	BXS12	30	34,0	BXS12	30	33,2											SCP12
25	1"	-16	BXS16	38	42	BXS16	38	41,8	BXS16	38	41,4											SCP16
31,5	1 1/4"	-20	BXS20	45	51	BXSH20	45	48,8	BXS20	45	49,9											SCP20
38	1 1/2"	-24	BXS24	50	60	BXSH24	50	57	BXS24	50	58,8											SCP24
51	2"	-32	BXS32	55	74	BXSH32	55	70,7	BXSH32	55	71,1											SCP32

** The application of "CX" series hose fittings must be limited to the "ISO 3862 4SP" maximum working pressure.

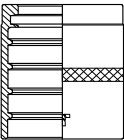
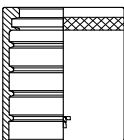
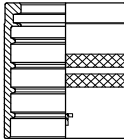
** L'applicazione dei raccordi per tubo flessibile serie "CX" deve essere limitata alla massima pressione di esercizio del tubo "ISO 3862 4SP".

NO-SKIVE					NO-SKIVE
	BX7	BX8	BP3	BXP	

RUBBER HOSES TEXTILE BRAIDED - TUBI GOMMA TRECCIATI TESSILI

Hose Size			ISO 4079 1TE			ISO 4079 2TE			ISO 4079 3TE			ISO 4079 R6 SAE100 R6			ISO 4079 R3 SAE100 R3					
			Ferrule Boccola	Skiving length Lungh. di pelatura	Ø Swage (Ref.) Ø Press. (Rif.)	Ferrule Boccola	Skiving length Lungh. di pelatura	Ø Swage (Ref.) Ø Press. (Rif.)	Ferrule Boccola	Skiving length Lungh. di pelatura	Ø Swage (Ref.) Ø Press. (Rif.)	Ferrule Boccola	Skiving length Lungh. di pelatura	Ø Swage (Ref.) Ø Press. (Rif.)	Ferrule Boccola	Skiving length Lungh. di pelatura	Ø Swage (Ref.) Ø Press. (Rif.)	Ferrule Boccola	Skiving length Lungh. di pelatura	Ø Swage (Ref.) Ø Press. (Rif.)
DN	Inch	Dash	Part.N.	mm	mm	Part.N.	mm	mm	Part.N.	mm	mm	Part.N.	mm	mm	Part.N.	mm	mm	Part.N.	mm	mm
5	3/16"	-03	BX703	no-skive																
6,3	1/4"	-04	BX704	no-skive		BP304	no-skive		BP304	no-skive		BX704	no-skive		BP304	no-skive				
8	5/16"	-05	BX705	no-skive		BX705	no-skive		BP305	no-skive		BX705	no-skive		BP305	no-skive				
10	3/8"	-06	BX706	no-skive		BX706	no-skive		BP306	no-skive		BX706	no-skive		BP306	no-skive				
12,5	1/2"	-08	BX708	no-skive		BX708	no-skive		BP308	no-skive		BX708	no-skive		BP308	no-skive				
16	5/8"	-10	BX710	no-skive		BX710	no-skive		BP310	no-skive		BX710	no-skive		BP310	no-skive				
19	3/4"	-12				BX712	no-skive		BP312	no-skive		BX712	no-skive		BP312	no-skive				
25	1"	-16				BX816	no-skive		BP316	no-skive					BP316	no-skive				
31,5	1 1/4"	-20							BP320	no-skive					BP320	no-skive				
38	1 1/2"	-24							BXP24	no-skive										
51	2"	-32							BXP32	no-skive										

NO-SKIVE

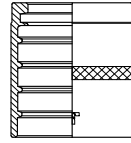

BX7

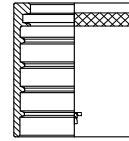



BX8

NO-SKIVE



THERMOPLASTIC HOSES - TUBI TERMOPLASTICI

Hose Size			ISO 3949 R7 SAE100 R7			ISO 3949 R8 SAE100 R8			ISO 3949 R18 SAE100 R18									Collapse control mandrel Spina controllo collasso				
			Ferrule Boccola	Skiving length Lungh. di pelatura	Ø Swage (Ref.) Ø Press. (Rif.)	Ferrule Boccola	Skiving length Lungh. di pelatura	Ø Swage (Ref.) Ø Press. (Rif.)	Ferrule Boccola	Skiving length Lungh. di pelatura	Ø Swage (Ref.) Ø Press. (Rif.)	Ferrule Boccola	Skiving length Lungh. di pelatura	Ø Swage (Ref.) Ø Press. (Rif.)	Ferrule Boccola	Skiving length Lungh. di pelatura	Ø Swage (Ref.) Ø Press. (Rif.)		Ferrule Boccola	Skiving length Lungh. di pelatura	Ø Swage (Ref.) Ø Press. (Rif.)	
DN	Inch	Dash	Part.N.	mm	mm	Part.N.	mm	mm	Part.N.	mm	mm	Part.N.	mm	mm	Part.N.	mm	mm	Part.N.	mm	mm	Part.N.	
5	3/16"	-03	BX703	no-skive		BX703	no-skive			no-skive												SCP03
6,3	1/4"	-04	BX704	no-skive		BX704	no-skive			no-skive												SCP04
8	5/16"	-05	BX705	no-skive		BX705	no-skive			no-skive												SCP05
10	3/8"	-06	BX706	no-skive		BX706	no-skive			no-skive												SCP06
12,5	1/2"	-08	BX708	no-skive		BX708	no-skive			no-skive												SCP08
16	5/8"	-10	BX710	no-skive		BX710	no-skive			no-skive												SCP10
19	3/4"	-12	BX712	no-skive		BX712	no-skive			no-skive												SCP12
25	1"	-16	BX716	no-skive		BX816	no-skive			no-skive												SCP16
31,5	1 1/4"	-20																				SCP20
38	1 1/2"	-24																				
51	2"	-32																				



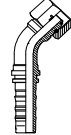
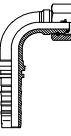

FERRULES

REFERENCE	DESCRIPTION	PAGE	REFERENCE	DESCRIPTION	PAGE
BSN4	 <p>NO-SKIVE FERRULE FOR SPIRAL HOSES BOCCOLA PER TUBI SPIRALATI SENZA PELATURA</p>	85	BSS6	 <p>SKIVE FERRULE FOR SPIRAL HOSES BOCCOLA PER TUBI SPIRALATI CON PELATURA</p>	85
BSS4	 <p>SKIVE FERRULE FOR SPIRAL HOSES BOCCOLA PER TUBI SPIRALATI CON PELATURA</p>	85			

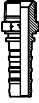

BRITISH STANDARD CONNECTIONS

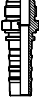
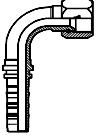
REFERENCE	DESCRIPTION	PAGE	REFERENCE	DESCRIPTION	PAGE
CS-MGC	 <p>BSP TAPERED MALE 60° CONE SEAT MASCHIO GAS CONICO SVASATO 60°</p>	86	CS-FGO	 <p>BSP FEMALE 60° O-RING CONE TIEFFE NUT BS 5200 - ISO 12151-6 FEMMINA GAS OGIVA 60° O-RING DADO TIEFFE BS 5200 - ISO 12151-6</p>	87
CS-MG	 <p>BSP PARALLEL MALE 60° CONE SEAT BS 5200 - ISO 12151-6 MASCHIO GAS CILINDRICO SVASATO 60° BS 5200 - ISO 12151-6</p>	86	CS-FGO45	 <p>BSP FEMALE 60° O RING CONE 45° ELBOW - TIEFFE NUT BS 5200 - ISO 12151-6 FEMMINA GAS OGIVA 60° O-RING CURVA A 45° - DADO TIEFFE BS 5200 - ISO 12151-6</p>	87
			CS-FGO90	 <p>BSP FEMALE 60° O RING CONE 90° ELBOW - TIEFFE NUT BS 5200 - ISO 12151-6 FEMMINA GAS OGIVA 60° O-RING CURVA A 90° - DADO TIEFFE BS 5200 - ISO 12151-6</p>	87

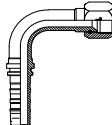
AMERICAN STANDARD CONNECTIONS - NPTF - JIC 37°

REFERENCE	DESCRIPTION	PAGE	REFERENCE	DESCRIPTION	PAGE
CS-NPT	 <p>NPTF MALE 60° CONE SEAT SAE J516 MASCHIO NPTF SVASATO 60° SAE J516</p>	88	CS-FIS45	 <p>JIC FEMALE 37° CONE SEAT 45° ELBOW - TIEFFE NUT SAE J516 - ISO 12151-5 FEMMINA JIC SVASATA 37° CURVA A 45° - DADO TIEFFE SAE J516 - ISO 12151-5</p>	89
CS-MI	 <p>JIC MALE 37° CONE SAE J516 - ISO 12151-5 MASCHIO JIC CONO 37° SAE J516 - ISO 12151-5</p>	88	CS-FIS90	 <p>JIC FEMALE 37° CONE SEAT 90° ELBOW - TIEFFE NUT SAE J516 - ISO 12151-5 FEMMINA JIC SVASATA 37° CURVA A 90° - DADO TIEFFE SAE J516 - ISO 12151-5</p>	90
CS-FIC	 <p>JIC FEMALE 37° CONE SEAT DOUBLE EXAGON - TIEFFE NUT SAE J516 - ISO 12151-5 FEMMINA JIC SVASATA 37° DOPPIO ESAGONO - DADO TIEFFE SAE J516 - ISO 12151-5</p>	89	CS-FIS90-K-	 <p>JIC FEMALE 37° CONE SEAT 90° ELBOW - LONG DROP - TIEFFE NUT SAE J516 - ISO 12151-5 FEMMINA JIC SVASATA 37° CURVA A 90° - LUNGA - DADO TIEFFE SAE J516 - ISO 12151-5</p>	90

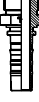

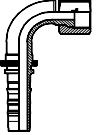
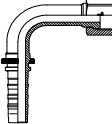
AMERICAN STANDARD CONNECTIONS - ORFS (SAE J516 / ISO 12151-1)

REFERENCE	DESCRIPTION	PAGE	REFERENCE	DESCRIPTION	PAGE
CS-MRS	 <p>ORFS MALE MASCHIO ORFS</p>	91	CS-FRS45	 <p>ORFS FEMALE 45° ELBOW - SLIP-ON NUT FEMMINA ORFS CURVA A 45° - DADO LIBERO</p>	92
CS-FRC	 <p>ORFS FEMALE DOUBLE EXAGON - CRIMPED-BACK NUT FEMMINA ORFS DOPPIO ESAGONO - DADO PRESSATO</p>	91	CS-FRS90	 <p>ORFS FEMALE 90° ELBOW - SHORT DROP SLIP-ON NUT FEMMINA ORFS CURVA A 90° - CORTA DADO LIBERO</p>	92
			CS-FRS90-K-	 <p>ORFS FEMALE 90° ELBOW - LONG DROP SLIP-ON NUT FEMMINA ORFS CURVA A 90° - LUNGA DADO LIBERO</p>	92

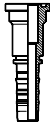
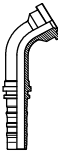
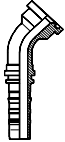
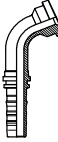
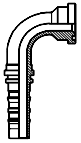
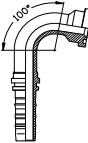
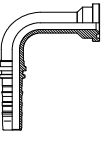
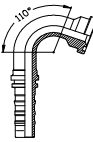
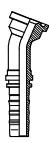
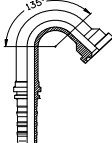
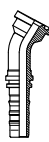

AMERICAN STANDARD CONNECTIONS - FLANGE CODE 61 (SAE J516 / ISO 12151-3)

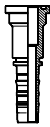
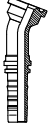
REFERENCE	DESCRIPTION	PAGE	REFERENCE	DESCRIPTION	PAGE
 CS-FL	SAE CODE 61 FLANGE FLANGIA SAE CODE 61	93	 CS-FL60	SAE CODE 61 FLANGE 60° ELBOW FLANGIA SAE CODE 61 CURVA A 60°	96
 CS-FL45	SAE CODE 61 FLANGE 45° ELBOW FLANGIA SAE CODE 61 CURVA A 45°	93	 CS-FL67	SAE CODE 61 FLANGE 67,5° ELBOW FLANGIA SAE CODE 61 CURVA A 67,5°	96
 CX-FL90	SAE CODE 61 FLANGE 90° ELBOW FLANGIA SAE CODE 61 CURVA A 90°	94	 CS-FL100	SAE CODE 61 FLANGE 100° ELBOW FLANGIA SAE CODE 61 CURVA A 100°	97
 CS-FL90-K-	SAE CODE 61 FLANGE 90° ELBOW - LONG DROP FLANGIA SAE CODE 61 CURVA A 90° - LUNGA	94	 CS-FL110	SAE CODE 61 FLANGE 110° ELBOW - LONG DROP FLANGIA SAE CODE 61 CURVA A 110° - LUNGA	97
 CS-FL22	SAE CODE 61 FLANGE 22,5° ELBOW FLANGIA SAE CODE 61 CURVA A 22,5°	95	 CS-FL135	SAE CODE 61 FLANGE 135° ELBOW FLANGIA SAE CODE 61 CURVA A 135°	97
 CS-FL30	SAE CODE 61 FLANGE 30° ELBOW FLANGIA SAE CODE 61 CURVA A 30°	95			

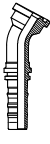
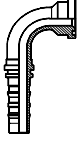
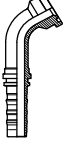
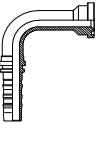
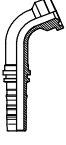
AMERICAN STANDARD CONNECTIONS - FLANGE CODE 62 (SAE J516 / ISO 12151-3)

REFERENCE	DESCRIPTION	PAGE	REFERENCE	DESCRIPTION	PAGE
CS-FP	 SAE CODE 62 FLANGE <i>FLANGIA SAE CODE 62</i>	98	CS-FP22	 SAE CODE 62 FLANGE 22,5° ELBOW <i>FLANGIA SAE CODE 62 CURVA A 22,5°</i>	100
CS-FP45	 SAE CODE 62 FLANGE 45° ELBOW <i>FLANGIA SAE CODE 62 CURVA A 45°</i>	98	CS-FP30	 SAE CODE 62 FLANGE 30° ELBOW <i>FLANGIA SAE CODE 62 CURVA A 30°</i>	100
CS-FP90	 SAE CODE 62 FLANGE 90° ELBOW <i>FLANGIA SAE CODE 62 CURVA A 90°</i>	99	CS-FP60	 SAE CODE 62 FLANGE 60° ELBOW <i>FLANGIA SAE CODE 62 CURVA A 60°</i>	101
CS-FP90-K-	 SAE CODE 62 FLANGE 90° ELBOW - LONG DROP <i>FLANGIA SAE CODE 62 CURVA A 90° - LUNGA</i>	99	CS-FP67	 SAE CODE 62 FLANGE 67,5° ELBOW <i>FLANGIA SAE CODE 62 CURVA A 67,5°</i>	101

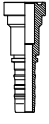
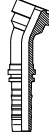
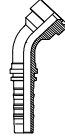
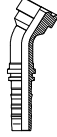
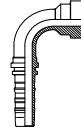
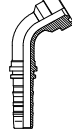
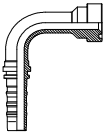
OEM CONNECTIONS - "SUPERCAT" FLANGE

REFERENCE	DESCRIPTION	PAGE	REFERENCE	DESCRIPTION	PAGE
 CS-YP	"SUPERCAT" FLANGE FLANGIA "SUPERCAT"	102	 CS-YP22	"SUPERCAT" FLANGE 22,5° ELBOW FLANGIA "SUPERCAT" CURVA A 22,5°	104
 CS-YP45	"SUPERCAT" FLANGE 45° ELBOW FLANGIA "SUPERCAT" CURVA A 45°	102	 CS-YP30	"SUPERCAT" FLANGE 30° ELBOW FLANGIA "SUPERCAT" CURVA A 30°	104
 CS-YP90	"SUPERCAT" FLANGE 90° ELBOW FLANGIA "SUPERCAT" CURVA A 90°	103	 CS-YP60	"SUPERCAT" FLANGE 60° ELBOW FLANGIA "SUPERCAT" CURVA A 60°	105
 CS-YP90-K-	"SUPERCAT" FLANGE 90° ELBOW - LONG DROP FLANGIA "SUPERCAT" CURVA A 90° - LUNGA	103	 CS-YP67	"SUPERCAT" FLANGE 67,5° ELBOW FLANGIA "SUPERCAT" CURVA A 67,5°	105
			 DR	D'RING SEAL FOR "SUPERCAT" FLANGES GUARNIZIONI D'RING PER FLANGE "SUPERCAT"	105

DIN STANDARD CONNECTIONS (DIN20066 / ISO12151-2)

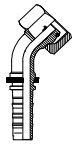
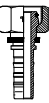
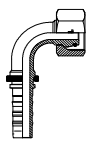
REFERENCE	DESCRIPTION	PAGE	REFERENCE	DESCRIPTION	PAGE
 CS-MM	METRIC MALE 24° CONE SEAT MASCHIO METRICO SVASATO 24°	106	 CS-FOS45	METRIC FEMALE 24° O'RING CONE 45° ELBOW - SLIP-ON NUT FEMM. METR. OGIVA 24° O'RING CURVA A 45° - DADO LIBERO	107
 CS-FOS	METRIC FEMALE 24° O'RING CONE SLIP-ON NUT FEMMINA METRICA OGIVA 24° O'RING DADO LIBERO	106	 CS-FOS90	METRIC FEMALE 24° O'RING CONE 90° ELBOW - SLIP-ON NUT FEMM. METR. OGIVA 24° O'RING CURVA A 90° - DADO LIBERO	107

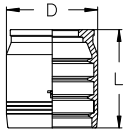
BSN4
SWAGED NO-SKIVE FERRULE
BOCCOLA A PRESSARE SENZA PELATURA

TIEFFE Part.N.	Hose Size			Dimensions (mm)		Applications Applicazioni					
	DN	Inch	Dash	D	L						
BSN412	19	3/4"	-12	43	50	4SP	4SH	R12	R13	R15	
BSN416	25	1"	-16	51	56	4SP	4SH	R12	R13	R15	
BSN420	31,5	1 1/4"	-20	61	68		4SH	R12			
BSN424	38	1 1/2"	-24	70	86		4SH	R12			
BSN432	51	2"	-32	85	100		4SH	R12			

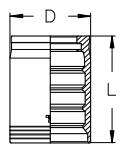
BSS4
SWAGED OUTSIDE SKIVE FERRULE
BOCCOLA A PRESSARE CON PELATURA ESTERNA

TIEFFE Part.N.	Hose Size			Dimensions (mm)		Applications Applicazioni					
	DN	Inch	Dash	D	L						
BSS412	19	3/4"	-12	38	54	4SP	4SH	R12	R13	R15	
BSS416	25	1"	-16	46	60	4SP	4SH	R12	R13	R15	
BSS420	31,5	1 1/4"	-20	54	72		4SH	R12			
BSS424	38	1 1/2"	-24	62	90		4SH	R12			
BSS432	51	2"	-32	76	102		4SH	R12			

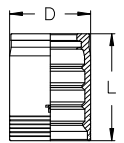
BSS6
SWAGED OUTSIDE SKIVE FERRULE
BOCCOLA A PRESSARE CON PELATURA ESTERNA

TIEFFE Part.N.	Hose Size			Dimensions (mm)		Applications Applicazioni					
	DN	Inch	Dash	D	L						
BSS620	31,5	1 1/4"	-20	58	72	4SP				R13	R15
BSS624	38	1 1/2"	-24	68	90	4SP				R13	R15
BSS632	51	2"	-32	84	102	4SP				R13	

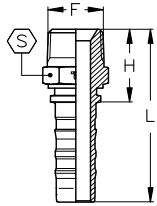
MGC
BSP TAPERED MALE 60° CONE SEAT
MASCHIO GAS CONICO SVASATO 60°
AGR-K

TIEFFE Part.N.	Hose Size			BSP Connection Size		Dimensions (mm)				Maximum W.P.	
	DN	Inch	Dash	F	Dash	H	L	S		bar	PSI
CS1212MGC	19	3/4"	-12	3/4"-14	-12	37	88	27		280	4000
CS1616MGC	25	1"	-16	1"-11	-16	44	101	36		280	4000
CS2020MGC	31,5	1 1/4"	-20	1 1/4"-11	-20	51	118	46		210	3000
CS2424MGC	38	1 1/2"	-24	1 1/2"-11	-24	54	137	50		185	2700
CS3232MGC	51	2"	-32	2"-11	-32	64	160	65		175	2500

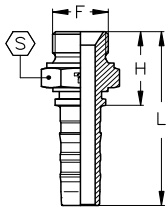
MG
BSP PARALLEL MALE 60° CONE SEAT
MASCHIO GAS CILINDRICO SVASATO 60°
AGR

TIEFFE Part.N.	Hose Size			BSP Connection Size		Dimensions (mm)				Maximum W.P.	
	DN	Inch	Dash	F	Dash	H	L	S		bar	PSI
CS1212MG	19	3/4"	-12	3/4"-14	-12	38	89	32		420	6000
CS1216MG	19	3/4"	-12	1"-11	-16	43	94	41		380	5500
CS1616MG	25	1"	-16	1"-11	-16	45	101	41		380	5500
CS1620MG	25	1"	-16	1 1/4"-11	-20	48	104	50		325	4700
CS2020MG	31,5	1 1/4"	-20	1 1/4"-11	-20	50	117	50		325	4700
CS2024MG	31,5	1 1/4"	-20	1 1/2"-11	-24	53	120	55		290	4200
CS2424MG	38	1 1/2"	-24	1 1/2"-11	-24	55	138	55		290	4200
CS3232MG	51	2"	-32	2"-11	-32	63	159	70		250	3600

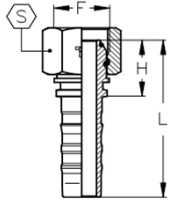
FGO
BSP FEMALE 60° O-RING CONE - TIEFFE NUT
FEMMINA GAS OGIVA 60° O-RING - DADO TIEFFE
DKOR

TIEFFE Part.N.	Hose Size			BSP Connection Size		Dimensions (mm)					Maximum W.P.	
	DN	Inch	Dash	F	Dash	H	L	S	O-RING	bar	PSI	
CS1212FGO	19	3/4"	-12	3/4"-14	-12	29	80	32	17x1,5	420	6000	
CS1216FGO	19	3/4"	-12	1"-11	-16	33	84	41	22x1,5	380	5500	
CS1616FGO	25	1"	-16	1"-11	-16	34	90	41	22x1,5	380	5500	
CS1620FGO	25	1"	-16	1 1/4"-11	-20	38	95	50	28,3x1,78	325	4700	
CS2020FGO	31,5	1 1/4"	-20	1 1/4"-11	-20	39	106	50	28,3x1,78	325	4700	
CS2024FGO	31,5	1 1/4"	-20	1 1/2"-11	-24	42	109	60	33,05x1,78	290	4200	
CS2424FGO	38	1 1/2"	-24	1 1/2"-11	-24	43	125	60	33,05x1,78	290	4200	
CS3232FGO	51	2"	-32	2"-11	-32	47	143	75	44,17x1,78	250	3600	

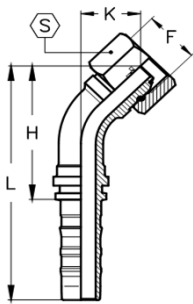
FGO45
BSP FEMALE 60° O-RING CONE - 45° ELBOW - TIEFFE NUT
FEMMINA GAS OGIVA 60° O-RING - CURVA A 45° - DADO TIEFFE
DKOR45

TIEFFE Part.N.	Hose Size			BSP Connection Size		Dimensions (mm)					Maximum W.P.	
	DN	Inch	Dash	F	Dash	H	L	S	K	O-RING	bar	PSI
CS1212FGO45	19	3/4"	-12	3/4"-14	-12	67	118	32	29	17x1,5	420	6000
CS1216FGO45	19	3/4"	-12	1"-11	-16	70	121	41	32	22x1,5	380	5500
CS1616FGO45	25	1"	-16	1"-11	-16	86	142	41	36	22x1,5	380	5500
CS1620FGO45	25	1"	-16	1 1/4"-11	-20	87	143	50	37	28,3x1,78	325	4700
CS2020FGO45	31,5	1 1/4"	-20	1 1/4"-11	-20	103	169	50	43	28,3x1,78	325	4700
CS2024FGO45	31,5	1 1/4"	-20	1 1/2"-11	-24	103	169	60	43	33,05x1,78	290	4200
CS2424FGO45	38	1 1/2"	-24	1 1/2"-11	-24	123	206	60	51	33,05x1,78	290	4200
CS3232FGO45	51	2"	-32	2"-11	-32	160	257	75	65	44,17x1,78	250	3600

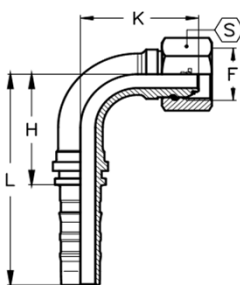
FGO90
BSP FEMALE 60° O-RING CONE - 90° ELBOW - TIEFFE NUT
FEMMINA GAS OGIVA 60° O-RING - CURVA A 90° - DADO TIEFFE
DKOR90

TIEFFE Part.N.	Hose Size			BSP Connection Size		Dimensions (mm)					Maximum W.P.	
	DN	Inch	Dash	F	Dash	H	L	S	K	O-RING	bar	PSI
CS1212FGO90	19	3/4"	-12	3/4"-14	-12	55	106	32	57	17x1,5	420	6000
CS1216FGO90	19	3/4"	-12	1"-11	-16	55	106	41	61	22x1,5	380	5500
CS1616FGO90	25	1"	-16	1"-11	-16	71	128	41	72	22x1,5	380	5500
CS1620FGO90	25	1"	-16	1 1/4"-11	-20	71	128	50	74	28,3x1,78	325	4700
CS2020FGO90	31,5	1 1/4"	-20	1 1/4"-11	-20	87	154	50	88	28,3x1,78	325	4700
CS2024FGO90	31,5	1 1/4"	-20	1 1/2"-11	-24	87	154	60	88	33,05x1,78	290	4200
CS2424FGO90	38	1 1/2"	-24	1 1/2"-11	-24	105	188	60	104	33,05x1,78	290	4200
CS3232FGO90	51	2"	-32	2"-11	-32	140	237	75	137	44,17x1,78	250	3600

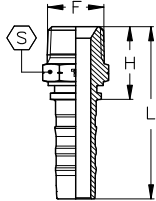
NPT
NPTF MALE 60° CONE SEAT
MASCHIO NPTF SVASATO 60°
AGN

TIEFFE Part.N.	Hose Size			NPTF Connection Size		Dimensions (mm)					Maximum W.P.	
	DN	Inch	Dash	F	Dash	H	L	S			bar	PSI
CS1212NPT	19	3/4"	-12	3/4"-14	-12	39	90	27			280	4000
CS1216NPT	19	3/4"	-12	1"-11,5	-16	47	98	36			280	4000
CS1612NPT	25	1"	-16	3/4"-14	-12	41,5	98	32			280	4000
CS1616NPT	25	1"	-16	1"-11,5	-16	48,5	105	36			280	4060
CS1620NPT	25	1"	-16	1 1/4"-11,5	-20	53	109,5	46			210	3000
CS2016NPT	31,5	1 1/4"	-20	1"-11,5	-16	52,5	119	41			210	3000
CS2020NPT	31,5	1 1/4"	-20	1 1/4"-11,5	-20	55	121,5	46			210	3000
CS2024NPT	31,5	1 1/4"	-20	1 1/2"-11,5	-24	59	125,5	50			185	2700
CS2424NPT	38	1 1/2"	-24	1 1/2"-11,5	-24	61	143,5	50			185	2700
CS2432NPT	38	1 1/2"	-24	2"-11,5	-32	67,5	150	65			175	2500
CS3232NPT	51	2"	-32	2"-11,5	-32	70,5	167	65			175	2500

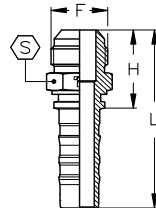
MI
JIC MALE 37° CONE
MASCHIO JIC CONO 37°
AGJ

TIEFFE Part.N.	Hose Size			JIC 37° Connection Size		Dimensions (mm)					Maximum W.P.	
	DN	Inch	Dash	F	Dash	H	L	S			bar	PSI
CS1210MI	19	3/4"	-12	7/8"-14	-10	37	88	27			350	5000
CS1212MI	19	3/4"	-12	1 1/16"-12	-12	40	91	27			350	5000
CS1214MI	19	3/4"	-12	1 3/16"-12	-14	41,5	92,5	32			350	5000
CS1216MI	19	3/4"	-12	1 5/16"-12	-16	43	94	36			280	4000
CS1612MI	25	1"	-16	1 1/16"-12	-12	43	99,5	32			350	5000
CS1616MI	25	1"	-16	1 5/16"-12	-16	45	101,5	36			280	4000
CS1620MI	25	1"	-16	1 5/8"-12	-20	48	104,5	46			210	3000
CS2016MI	31,5	1 1/4"	-20	1 5/16"-12	-16	48,5	115	41			280	4000
CS2020MI	31,5	1 1/4"	-20	1 5/8"-12	-20	50,5	117	46			210	3000
CS2024MI	31,5	1 1/4"	-20	1 7/8"-12	-24	55	121,5	50			185	2700
CS2424MI	38	1 1/2"	-24	1 7/8"-12	-24	57	139,5	50			185	2700
CS2432MI	38	1 1/2"	-24	2 1/2"-12	-32	65,5	148	65			175	2500
CS3232MI	51	2"	-32	2 1/2"-12	-32	68,5	165	65			175	2500

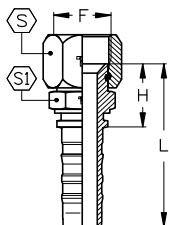
FIC
JIC FEMALE 37° CONE SEAT - DOUBLE EXAGON - TIEFFE NUT
FEMMINA JIC SVASATA 37° - DOPPIO ESAGONO - DADO TIEFFE
DKJ

TIEFFE Part.N.	Hose Size			JIC 37° Connection Size		Dimensions (mm)				Maximum W.P.	
	DN	Inch	Dash	F	Dash	H	L	S	S1	bar	PSI
CS1210FIC	19	3/4"	-12	7/8"-14	-10	33	84	27	27	350	5000
CS1212FIC	19	3/4"	-12	1 1/16"-12	-12	34	85	32	27	350	5000
CS1214FIC	19	3/4"	-12	1 3/16"-12	-14	35,5	86,5	36	30	280	4000
CS1216FIC	19	3/4"	-12	1 5/16"-12	-16	38	89	41	32	280	4000
CS1612FIC	25	1"	-16	1 1/16"-12	-12	36,5	93	32	32	350	5000
CS1616FIC	25	1"	-16	1 5/16"-12	-16	39,5	96	41	32	280	4000
CS1620FIC	25	1"	-16	1 5/8"-12	-20	46	102,5	50	41	210	3000
CS2016FIC	31,5	1 1/4"	-20	1 5/16"-12	-16	45,5	112	41	41	280	4000
CS2020FIC	31,5	1 1/4"	-20	1 5/8"-12	-20	48	114,5	50	41	210	3000
CS2024FIC	31,5	1 1/4"	-20	1 7/8"-12	-24	51	117,5	60	46	185	2700
CS2424FIC	38	1 1/2"	-24	1 7/8"-12	-24	53	135,5	60	46	185	2700
CS2432FIC	38	1 1/2"	-24	2 1/2"-12	-32	66	148,5	75	60	175	2500
CS3232FIC	51	2"	-32	2 1/2"-12	-32	69	165,5	75	60	175	2500

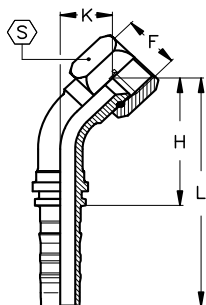
FIS45
JIC FEMALE 37° CONE SEAT - 45° ELBOW - TIEFFE NUT
FEMMINA JIC SVASATA 37° - CURVA A 45° - DADO TIEFFE
DKJ45

TIEFFE Part.N.	Hose Size			JIC 37° Connection Size		Dimensions (mm)				Maximum W.P.	
	DN	Inch	Dash	F	Dash	H	L	K	S	bar	PSI
CS1210FIS45	19	3/4"	-12	7/8"-14	-10	66	117	28	27	350	5000
CS1212FIS45	19	3/4"	-12	1 1/16"-12	-12	63	114	25	32	350	5000
CS1214FIS45	19	3/4"	-12	1 3/16"-12	-14	63	114	25	36	280	4000
CS1216FIS45	19	3/4"	-12	1 5/16"-12	-16	66	117	28	41	280	4000
CS1612FIS45	25	1"	-16	1 1/16"-12	-12	85	141	35	32	350	5000
CS1616FIS45	25	1"	-16	1 5/16"-12	-16	82	138	32	41	280	4000
CS1620FIS45	25	1"	-16	1 5/8"-12	-20	83	140	33	50	210	3000
CS2016FIS45	31,5	1 1/4"	-20	1 5/16"-12	-16	100	167	41	41	280	4000
CS2020FIS45	31,5	1 1/4"	-20	1 5/8"-12	-20	98	164	38	50	210	3000
CS2024FIS45	31,5	1 1/4"	-20	1 7/8"-12	-24	99	165	39	60	185	2700
CS2424FIS45	38	1 1/2"	-24	1 7/8"-12	-24	118	201	46	60	185	2700
CS2432FIS45	38	1 1/2"	-24	2 1/2"-12	-32	122	204	50	75	175	2500
CS3232FIS45	51	2"	-32	2 1/2"-12	-32	157	253	62	75	175	2500

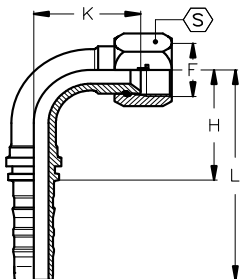
FIS90
JIC FEMALE 37° CONE SEAT - 90° ELBOW - TIEFFE NUT
FEMMINA JIC SVASATA 37° - CURVA A 90° - DADO TIEFFE
DKJ90

TIEFFE Part.N.	Hose Size			JIC 37° Connection Size		Dimensions (mm)				Maximum W.P.	
	DN	Inch	Dash	F	Dash	H	L	K	S	bar	PSI
CS1210FIS90	19	3/4"	-12	7/8"-14	-10	55	106	55	27	350	5000
CS1212FIS90	19	3/4"	-12	1 1/16"-12	-12	55	106	52	32	350	5000
CS1214FIS90	19	3/4"	-12	1 3/16"-12	-14	55	106	52	36	280	4000
CS1216FIS90	19	3/4"	-12	1 5/16"-12	-16	55	106	56	41	280	4000
CS1612FIS90	25	1"	-16	1 1/16"-12	-12	71	128	71	32	350	5000
CS1616FIS90	25	1"	-16	1 5/16"-12	-16	71	128	67	41	280	4000
CS1620FIS90	25	1"	-16	1 5/8"-12	-20	71	128	69	50	210	3000
CS2016FIS90	31,5	1 1/4"	-20	1 5/16"-12	-16	87	154	84	41	280	4000
CS2020FIS90	31,5	1 1/4"	-20	1 5/8"-12	-20	87	154	81	50	210	3000
CS2024FIS90	31,5	1 1/4"	-20	1 7/8"-12	-24	87	154	82	60	185	2700
CS2424FIS90	38	1 1/2"	-24	1 7/8"-12	-24	105	188	97	60	185	2700
CS2432FIS90	38	1 1/2"	-24	2 1/2"-12	-32	105	188	102	75	175	2500
CS3232FIS90	51	2"	-32	2 1/2"-12	-32	140	237	132	75	175	2500

FIS90

LONG DROP

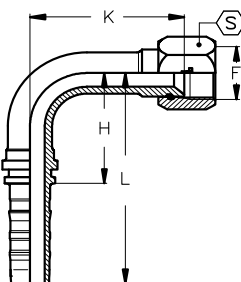
JIC FEMALE 37° CONE SEAT - 90° ELBOW - LONG DROP - CRIMPED-BACK NUT
FEMMINA JIC SVASATA 37° - CURVA A 90° LUNGA - DADO PRESSATO
DKJ90
 LONG DROP

TIEFFE Part.N.	Hose Size			JIC 37° Connection Size		Dimensions (mm)				Maximum W.P.	
	DN	Inch	Dash	F	Dash	H	L	K	S	bar	PSI
CS1212FIS90-K96	19	3/4"	-12	1 1/16"-12	-12	55	106	96	32	350	5000
CS1616FIS90-K116	25	1"	-16	1 5/16"-12	-16	71	128	116	41	280	4000
CS1620FIS90-K116	25	1"	-16	1 5/8"-12	-20	71	128	116	50	210	3000
CS2020FIS90-K136	31,5	1 1/4"	-20	1 5/8"-12	-20	87	154	136	50	210	3000
CS2424FIS90-K162	38	1 1/2"	-24	1 7/8"-12	-24	105	188	162	60	185	2700
CS3232FIS90-K220	51	2"	-32	2 1/2"-12	-32	140	137	220	75	175	2500

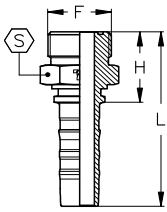
MRS

ORFS MALE
MASCHIO ORFS

AG ORFS

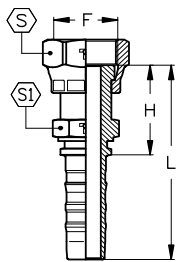
TIEFFE Part.N.	Hose Size			ORFS Connection Size		Dimensions (mm)					Maximum W.P.	
	DN	Inch	Dash	F	Dash	H	L	S	O-RING	bar	PSI	
CS1212MRS	19	3/4"	-12	1 3/16"-12	-12	36	87	32		18,77x1,78	420	6000
CS1616MRS	25	1"	-16	1 7/16"-12	-16	41	97	41		23,52x1,78	415	6000
CS2020MRS	31,5	1 1/4"	-20	1 11/16"-12	-20	44	111	46		29,87x1,78	345	5000
CS2424MRS	38	1 1/2"	-24	2"-12	-24	48	131	55		37,82x1,78	290	4200

FRC

ORFS FEMALE - DOUBLE EXAGON - CRIMPED-BACK NUT
FEMMINA ORFS - DOPPIO ESAGONO - DADO PRESSATO

DK ORFS

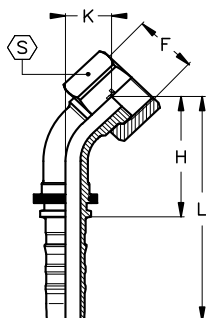
TIEFFE Part.N.	Hose Size			ORFS Connection Size		Dimensions (mm)					Maximum W.P.	
	DN	Inch	Dash	F	Dash	H	L	S	S1		bar	PSI
CS1210FRC	19	3/4"	-12	1"-14	-10	43	94	30	27		420	6000
CS1212FRC	19	3/4"	-12	1 3/16"-12	-12	46	97	36	30		420	6000
CS1216FRC	19	3/4"	-12	1 7/16"-12	-16	49	100	41	36		420	6000
CS1616FRC	25	1"	-25	1 7/16"-12	-16	51	107	41	36		415	6000
CS1620FRC	25	1"	-25	1 11/16"-12	-20	52	109	50	41		345	5000
CS2020FRC	31,5	1 1/4"	-20	1 11/16"-12	-20	55	121	50	41		345	5000
CS2424FRC	38	1 1/2"	-24	2"-12	-24	60	142	60	50		290	4200

FRS45
ORFS FEMALE - 45° ELBOW - SLIP-ON NUT
FEMMINA ORFS - CURVA A 45° - DADO LIBERO
DK ORFS 45

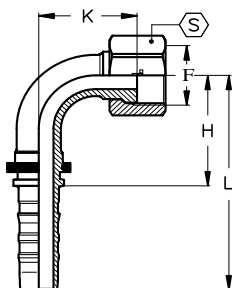
TIEFFE Part.N.	Hose Size			ORFS Connection Size		Dimensions (mm)				Maximum W.P.	
	DN	Inch	Dash	F	Dash	H	L	K	S	bar	PSI
CS1212FRS45	19	3/4"	-12	1 3/16"-12	-12	60	111	22	36	420	6000
CS1216FRS45	19	3/4"	-12	1 7/16"-12	-16	61	112	23	41	420	6000
CS1616FRS45	25	1"	-16	1 7/16"-12	-16	78	134	29	41	415	6000
CS1620FRS45	25	1"	-16	1 11/16"-12	-20	78	134	29	50	345	5000
CS2020FRS45	31,5	1 1/4"	-20	1 11/16"-12	-20	93	159	34	50	345	5000
CS2424FRS45	38	1 1/2"	-24	2"-12	-24	113	195	41	60	290	4200

FRS90
ORFS FEMALE - 90° ELBOW - SLIP-ON NUT
FEMMINA ORFS - CURVA A 90° - DADO LIBERO
DK ORFS 90

TIEFFE Part.N.	Hose Size			ORFS Connection Size		Dimensions (mm)				Maximum W.P.	
	DN	Inch	Dash	F	Dash	H	L	K	S	bar	PSI
CS1212FRS90	19	3/4"	-12	1 3/16"-12	-12	54	105	48	36	420	6000
CS1216FRS90	19	3/4"	-12	1 7/16"-12	-16	54	105	49	41	420	6000
CS1616FRS90	25	1"	-16	1 7/16"-12	-16	71	127	62	41	415	6000
CS1620FRS90	25	1"	-16	1 11/16"-12	-20	71	127	62	50	345	5000
CS2020FRS90	31,5	1 1/4"	-20	1 11/16"-12	-20	87	153	75	50	345	5000
CS2424FRS90	38	1 1/2"	-24	2"-12	-24	105	187	90	60	290	4200

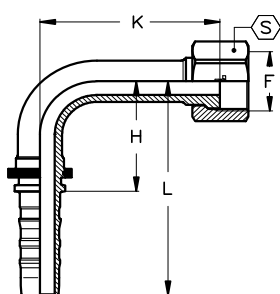
DK ORFS 90
LONG DROP
ORFS FEMALE - 90° ELBOW - LONG DROP - SLIP-ON NUT
FEMMINA ORFS - CURVA A 90° - LUNGA - DADO LIBERO
DK ORFS 90
LONG DROP

TIEFFE Part.N.	Hose Size			ORFS Connection Size		Dimensions (mm)				Maximum W.P.	
	DN	Inch	Dash	F	Dash	H	L	K	S	bar	PSI
CS1212FRS90-K96	19	3/4"	-12	1 3/16"-12	-12	54	105	96	36	420	6000
CS1616FRS90-K114	25	1"	-16	1 7/16"-12	-16	71	127	114	41	415	6000
CS2020FRS90-K130	31,5	1 1/4"	-20	1 11/16"-12	-20	87	153	130	50	345	5000
CS2424FRS90-K155	38	1 1/2"	-24	2"-12	-24	105	187	155	60	290	4200

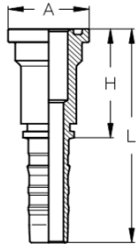
FL
SAE CODE 61 FLANGE
FLANGIA SAE CODE 61
SFL

TIEFFE Part.N.	Hose Size			Flange Size Connection		Dimensions (mm)					Maximum W.P.	
	DN	Inch	Dash	Inch	Dash	H	L	A			bar	PSI
CS1212FL	19	3/4"	-12	3/4"	-12	55	106	38,1			350	5000
CS1216FL	19	3/4"	-12	1"	-16	57	108	44,5			350	5000
CS1220FL	19	3/4"	-12	1 1/4"	-20	55	106	50,8			280	4000
CS1612FL	25	1"	-16	3/4"	-12	58	115	38,1			350	5000
CS1616FL	25	1"	-16	1"	-16	58	115	44,5			350	5000
CS1620FL	25	1"	-16	1 1/4"	-20	63	120	50,8			280	4000
CS1624FL	25	1"	-16	1 1/2"	-24	55	116	60,3			210	3000
CS2016FL	31,5	1 1/4"	-20	1"	-16	64	131	44,5			350	5000
CS2020FL	31,5	1 1/4"	-20	1 1/4"	-20	64	131	50,8			280	4000
CS2024FL	31,5	1 1/4"	-20	1 1/2"	-24	68	135	60,3			210	3000
CS2032FL	31,5	1 1/4"	-20	2"	-32	75	142	71,4			210	3000
CS2424FL	38	1 1/2"	-24	1 1/2"	-24	73	156	60,3			210	3000
CS2432FL	38	1 1/2"	-24	2"	-32	76	159	71,4			210	3000
CS3232FL	51	2"	-32	2"	-32	77	177	71,4			210	3000
CS3240FL	51	2"	-32	2 1/2"	-40	90	187	84,1			175	2500

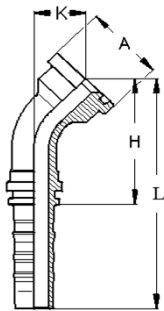
FL45
SAE CODE 61 FLANGE - 45° ELBOW
FLANGIA SAE CODE 61 - CURVA A 45°
SFL45

TIEFFE Part.N.	Hose Size			Flange Size Connection		3					Maximum W.P.	
	DN	Inch	Dash	Inch	Dash	H	L	K	A		bar	PSI
CS1212FL45	19	3/4"	-12	3/4"	-12	63	114	25	38,1		350	5000
CS1216FL45	19	3/4"	-12	1"	-16	65	116	27	44,5		350	5000
CS1612FL45	25	1"	-16	3/4"	-12	81	137	31	38,1		350	5000
CS1616FL45	25	1"	-16	1"	-16	78	134	28	44,5		350	5000
CS1620FL45	25	1"	-16	1 1/4"	-20	78	134	28	50,8		280	4000
CS2016FL45	31,5	1 1/4"	-20	1"	-16	96	163	37	44,5		350	5000
CS2020FL45	31,5	1 1/4"	-20	1 1/4"	-20	91	157	32	50,8		280	4000
CS2024FL45	31,5	1 1/4"	-20	1 1/2"	-24	91	157	32	60,3		210	3000
CS2424FL45	38	1 1/2"	-24	1 1/2"	-24	108	191	36	60,3		210	3000
CS2432FL45	38	1 1/2"	-24	2"	-32	107	189	35	71,4		210	3000
CS3232FL45	51	2"	-32	2"	-32	151	245	57	71,4		210	3000
CS3240FL45	51	2"	-32	2 1/2"	-40	146	243	51	84,1		175	2500

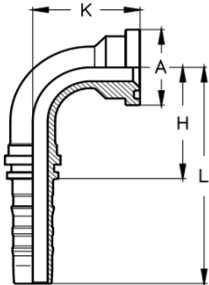
FL90
SAE CODE 61 FLANGE - 90° ELBOW
FLANGIA SAE CODE 61 - CURVA A 90°
SFL90

TIEFFE Part.N.	Hose Size			Flange Size Connection		Dimensions (mm)					Maximum W.P.		
	DN	Inch	Dash	Inch	Dash	H	L	K	A		bar	PSI	
CS1212FL90	19	3/4"	-12	3/4"	-12	55	106	51	38,1			350	5000
CS1216FL90	19	3/4"	-12	1"	-16	55	106	55	44,5			350	5000
CS1220FL90	19	3/4"	-12	1 1/4"	-20	55	106	60	50,8			280	4000
CS1612FL90	25	1"	-16	3/4"	-12	71	128	65	38,1			350	5000
CS1616FL90	25	1"	-16	1"	-16	71	128	61	44,5			350	5000
CS1620FL90	25	1"	-16	1 1/4"	-20	71	128	61	50,8			280	4000
CS1624FL90	25	1"	-16	1 1/2"	-24	71	128	61	60,3			210	3000
CS2016FL90	31,5	1 1/4"	-20	1"	-16	87	154	79	44,5			350	5000
CS2020FL90	31,5	1 1/4"	-20	1 1/4"	-20	87	154	71	50,8			280	4000
CS2024FL90	31,5	1 1/4"	-20	1 1/2"	-24	87	154	71	60,3			210	3000
CS2424FL90	38	1 1/2"	-24	1 1/2"	-24	105	188	83	60,3			210	3000
CS2432FL90	38	1 1/2"	-24	2"	-32	105	188	81	71,4			210	3000
CS3232FL90	51	2"	-32	2"	-32	140	237	122	71,4			210	3000
CS3240FL90	51	2"	-32	2 1/2"	-40	140	237	117	84,1			175	2500

FL 90

LONG DROP

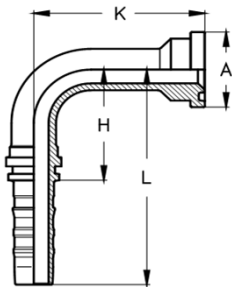
SAE CODE 61 FLANGE - 90° ELBOW - LONG DROP
FLANGIA SAE CODE 61 - CURVA A 90° - LUNGA
SFL90
 LONG DROP

TIEFFE Part.N.	Hose Size			Flange Size Connection		Dimensions (mm)					Maximum W.P.		
	DN	Inch	Dash	Inch	Dash	H	L	K	A		bar	PSI	
CS1212FL90-K96	19	3/4"	-12	3/4"	-12	55	106	96	38,1			350	5000
CS1212FL90-K127	19	3/4"	-12	3/4"	-12	55	106	127	38,1			350	5000
CS1216FL90-K79	19	3/4"	-12	1"	-16	55	106	79	44,5			350	5000
CS1616FL90-K118	25	1"	-16	1"	-16	71	128	118	44,5			350	5000
CS1620FL90-K118	25	1"	-16	1 1/4"	-20	71	128	118	50,8			280	4000
CS2020FL90-K91	31,5	1 1/4"	-20	1 1/4"	-20	87	154	91	50,8			280	4000
CS2020FL90-K102	31,5	1 1/4"	-20	1 1/4"	-20	87	154	102	50,8			280	4000
CS2020FL90-K112	31,5	1 1/4"	-20	1 1/4"	-20	87	154	112	50,8			280	4000
CS2020FL90-K130	31,5	1 1/4"	-20	1 1/4"	-20	87	154	130	50,8			280	4000
CS2020FL90-K168	31,5	1 1/4"	-20	1 1/4"	-20	87	154	168	50,8			280	4000
CS2024FL90-K118	31,5	1 1/4"	-20	1 1/2"	-24	87	154	118	60,3			210	3000
CS2024FL90-K130	31,5	1 1/4"	-20	1 1/2"	-24	87	154	130	60,3			210	3000
CS2424FL90-K148	38	1 1/2"	-24	1 1/2"	-24	105	188	148	60,3			210	3000
CS2424FL90-K172	38	1 1/2"	-24	1 1/2"	-24	105	188	172	60,3			210	3000
CS2432FL90-K115	38	1 1/2"	-24	2"	-32	105	188	115	71,4			210	3000
CS2432FL90-K172	38	1 1/2"	-24	2"	-32	105	188	172	71,4			210	3000
CS3232FL90-K165	51	2"	-32	2"	-32	140	237	165	71,4			210	3000
CS3232FL90-K203	51	2"	-32	2"	-32	140	237	203	71,4			210	3000

FL22
SAE CODE 61 FLANGE - 22,5° ELBOW
 FLANGIA SAE CODE 61 - CURVA A 22,5°

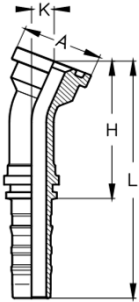
SFL22,5

TIEFFE Part.N.	Hose Size			Flange Size Connection		Dimensions (mm)					Maximum W.P.	
	DN	Inch	Dash	Inch	Dash	H	L	K	A		bar	PSI
CS1212FL22	19	3/4"	-12	3/4"	-12	70	121	11	38,1		350	5000
CS1216FL22	19	3/4"	-12	1"	-16	73	124	12	44,5		350	5000
CS1616FL22	25	1"	-16	1"	-16	86	142	12	44,5		350	5000
CS1620FL22	25	1"	-16	1 1/4"	-20	86	142	12	50,8		280	4000
CS2020FL22	31,5	1 1/4"	-20	1 1/4"	-20	100	166	13	50,8		280	4000
CS2024FL22	31,5	1 1/4"	-20	1 1/2"	-24	100	166	13	60,3		210	3000
CS2424FL22	38	1 1/2"	-24	1 1/2"	-24	118	201	15	60,3		210	3000
CS2432FL22	38	1 1/2"	-24	2"	-32	116	199	14	71,4		210	3000
CS3232FL22	51	2"	-32	2"	-32	165	262	22	71,4		210	3000

FL30
SAE CODE 61 FLANGE - 30° ELBOW
 FLANGIA SAE CODE 61 - CURVA A 30°

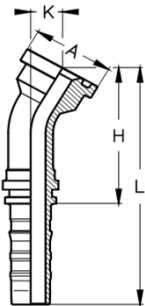
SFL30

TIEFFE Part.N.	Hose Size			Flange Size Connection		Dimensions (mm)					Maximum W.P.	
	DN	Inch	Dash	Inch	Dash	H	L	K	A		bar	PSI
CS1212FL30	19	3/4"	-12	3/4"	-12	68	119	16	38,1		350	5000
CS1216FL30	19	3/4"	-12	1"	-16	71	122	17	44,5		350	5000
CS1616FL30	25	1"	-16	1"	-16	84	140	17	44,5		350	5000
CS1620FL30	25	1"	-16	1 1/4"	-20	84	140	17	50,8		280	4000
CS2020FL30	31,5	1 1/4"	-20	1 1/4"	-20	98	164	19	50,8		280	4000
CS2024FL30	31,5	1 1/4"	-20	1 1/2"	-24	98	164	19	60,3		210	3000
CS2424FL30	38	1 1/2"	-24	1 1/2"	-24	116	199	22	60,3		210	3000
CS2432FL30	38	1 1/2"	-24	2"	-32	114	197	21	71,4		210	3000
CS3232FL30	51	2"	-32	2"	-32	162	258	31	71,4		210	3000

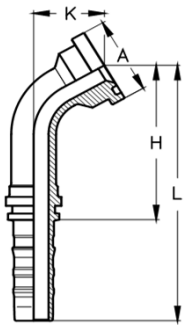
FL60
SAE CODE 61 FLANGE - 60° ELBOW
FLANGIA SAE CODE 61 - CURVA A 60°
SFL60

TIEFFE Part.N.	Hose Size			Flange Size Connection		Dimensions (mm)					Maximum W.P.	
	DN	Inch	Dash	Inch	Dash	H	L	K	A		bar	PSI
CS1212FL60	19	3/4"	-12	3/4"	-12	77	128	34	38,1		350	5000
CS1216FL60	19	3/4"	-12	1"	-16	79	130	37	44,5		350	5000
CS1616FL60	25	1"	-16	1"	-16	98	154	40	44,5		350	5000
CS1620FL60	25	1"	-16	1 1/4"	-20	98	154	40	50,8		280	4000
CS2020FL60	31,5	1 1/4"	-20	1 1/4"	-20	118	184	45	50,8		280	4000
CS2024FL60	31,5	1 1/4"	-20	1 1/2"	-24	118	184	45	60,3		210	3000
CS2424FL60	38	1 1/2"	-24	1 1/2"	-24	140	223	52	60,3		210	3000
CS2432FL60	38	1 1/2"	-24	2"	-32	139	222	50	71,4		210	3000
CS3232FL60	51	2"	-32	2"	-32	192	289	73	71,4		210	3000

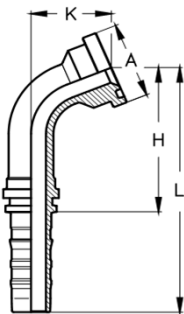
FL67
SAE CODE 61 FLANGE - 67,5° ELBOW
FLANGIA SAE CODE 61 - CURVA A 67,5°
SFL67,5

TIEFFE Part.N.	Hose Size			Flange Size Connection		Dimensions (mm)					Maximum W.P.	
	DN	Inch	Dash	Inch	Dash	H	L	K	A		bar	PSI
CS1212FL67	19	3/4"	-12	3/4"	-12	72	123	39	38,1		350	5000
CS1216FL67	19	3/4"	-12	1"	-16	73	124	41	44,5		350	5000
CS1616FL67	25	1"	-16	1"	-16	92	148	45	44,5		350	5000
CS1620FL67	25	1"	-16	1 1/4"	-20	92	148	45	50,8		280	4000
CS2020FL67	31,5	1 1/4"	-20	1 1/4"	-20	111	178	52	50,8		280	4000
CS2024FL67	31,5	1 1/4"	-20	1 1/2"	-24	111	178	52	60,3		210	3000
CS2424FL67	38	1 1/2"	-24	1 1/2"	-24	133	216	60	60,3		210	3000
CS2432FL67	38	1 1/2"	-24	2"	-32	132	215	58	71,4		210	3000
CS3232FL67	51	2"	-32	2"	-32	181	278	84	71,4		210	3000

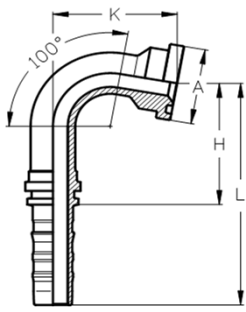
FL100
SAE CODE 61 FLANGE - 100° ELBOW
FLANGIA SAE CODE 61 - CURVA A 100°
SFL100

TIEFFE Part.N.	Hose Size			Flange Size Connection		Dimensions (mm)					Maximum W.P.	
	DN	Inch	Dash	Inch	Dash	H	L	K	A		bar	PSI
CS1212FL100	19	3/4"	-12	3/4"	-12	61	112	59	38,1		350	5000
CS1616FL100	25	1"	-16	1"	-16	77	134	68	44,5		350	5000

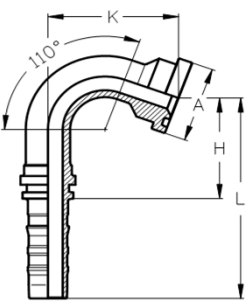
FL110
SAE CODE 61 FLANGE - 110° ELBOW
FLANGIA SAE CODE 61 - CURVA A 110°
SFL110

TIEFFE Part.N.	Hose Size			Flange Size Connection		Dimensions (mm)					Maximum W.P.	
	DN	Inch	Dash	Inch	Dash	H	L	K	A		bar	PSI
CS1212FL110	19	3/4"	-12	3/4"	-12	51	102	62	38,1		350	5000
CS1616FL110	25	1"	-16	1"	-16	65	121	73	44,5		350	5000
CS1620FL110	25	1"	-16	1 1/4"	-20	65	121	73	50,8		280	4000
CS2020FL110	31,5	1 1/4"	-20	1 1/4"	-20	82	148	83	50,8		280	4000
CS2024FL110	31,5	1 1/4"	-20	1 1/2"	-24	82	148	83	60,3		210	3000
CS2424FL110	38	1 1/2"	-24	1 1/2"	-24	95	178	97	60,3		210	3000
CS3232FL110	51	2"	-32	2"	-32	124	220	142	71,4		210	3000

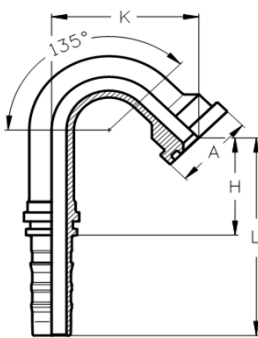
FL135
SAE CODE 61 FLANGE - 135° ELBOW
FLANGIA SAE CODE 61 - CURVA A 135°
SFL135

TIEFFE Part.N.	Hose Size			Flange Size Connection		Dimensions (mm)					Maximum W.P.	
	DN	Inch	Dash	Inch	Dash	H	L	K	A		bar	PSI
CS1212FL135	19	3/4"	-12	3/4"	-12	69	120	70	38,1		350	5000
CS1216FL135	19	3/4"	-12	1"	-16	69	120	70	44,5		350	5000
CS1616FL135	25	1"	-16	1"	-16	57	113	86	44,5		350	5000

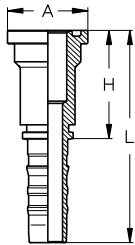
FP
SAE CODE 62 FLANGE
FLANGIA SAE CODE 62
SFS

TIEFFE Part.N.	Hose Size			Flange Size Connection		Dimensions (mm)					Maximum W.P.	
	DN	Inch	Dash	Inch	Dash	H	L	A			bar	PSI
CS1212FP	19	3/4"	-12	3/4"	-12	59	110	41,3			420	6000
CS1216FP	19	3/4"	-12	1"	-16	61	112	47,6			420	6000
CS1612FP	25	1"	-16	3/4"	-12	65	121,5	41,3			415	6000
CS1616FP	25	1"	-16	1"	-16	65	121,5	47,6			415	6000
CS1620FP	25	1"	-16	1 1/4"	-20	69	125,5	54			415	6000
CS2016FP	31,5	1 1/4"	-20	1"	-16	70	136,5	47,6			415	6000
CS2020FP	31,5	1 1/4"	-20	1 1/4"	-20	70	136,5	54			415	6000
CS2024FP	31,5	1 1/4"	-20	1 1/2"	-24	80	146,5	63,5			415	6000
CS2424FP	38	1 1/2"	-24	1 1/2"	-24	84	116,5	63,5			415	6000
CS2432FP	38	1 1/2"	-24	2"	-32	99	181,5	79,4			415	6000
CS3232FP	51	2"	-32	2"	-32	100	196,5	79,4			345	5000

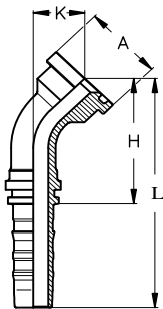
FP45
SAE CODE 62 FLANGE - 45° ELBOW
FLANGIA SAE CODE 62 - CURVA A 45°
SFS45

TIEFFE Part.N.	Hose Size			Flange Size Connection		Dimensions (mm)					Maximum W.P.	
	DN	Inch	Dash	Inch	Dash	H	L	K	A		bar	PSI
CS1212FP45	19	3/4"	-12	3/4"	-12	66	117	28	41,3		420	6000
CS1216FP45	19	3/4"	-12	1"	-16	68	118	29	47,6		420	6000
CS1612FP45	25	1"	-16	3/4"	-12	81	137	31	41,3		415	6000
CS1616FP45	25	1"	-16	1"	-16	80	136	30	47,6		415	6000
CS1620FP45	25	1"	-16	1 1/4"	-20	80	136	30	54		415	6000
CS2016FP45	31,5	1 1/4"	-20	1"	-16	96	163	37	47,6		415	6000
CS2020FP45	31,5	1 1/4"	-20	1 1/4"	-20	93	160	34	54		415	6000
CS2024FP45	31,5	1 1/4"	-20	1 1/2"	-24	94	161	35	63,5		415	6000
CS2424FP45	38	1 1/2"	-24	1 1/2"	-24	112	195	40	63,5		415	6000
CS2432FP45	38	1 1/2"	-24	2"	-32	115	198	43	79,4		415	6000
CS3232FP45	51	2"	-32	2"	-32	150	247	56	79,4		345	5000

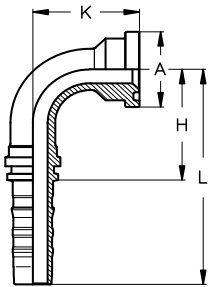
FP90
SAE CODE 62 FLANGE - 90° ELBOW
FLANGIA SAE CODE 62 - CURVA A 90°
SFS90

TIEFFE Part.N.	Hose Size			Flange Size Connection		Dimensions (mm)					Maximum W.P.	
	DN	Inch	Dash	Inch	Dash	H	L	K	A		bar	PSI
CS1212FP90	19	3/4"	-12	3/4"	-12	55	106	56	41,3		420	6000
CS1216FP90	19	3/4"	-12	1"	-16	55	106	58	47,6		420	6000
CS1612FP90	25	1"	-16	3/4"	-12	71	128	65	41,3		415	6000
CS1616FP90	25	1"	-16	1"	-16	71	128	64	47,6		415	6000
CS1620FP90	25	1"	-16	1 1/4"	-20	71	128	64	54		415	6000
CS2016FP90	31,5	1 1/4"	-20	1"	-16	87	154	79	47,6		415	6000
CS2020FP90	31,5	1 1/4"	-20	1 1/4"	-20	87	154	74	54		415	6000
CS2024FP90	31,5	1 1/4"	-20	1 1/2"	-24	87	154	76	63,5		415	6000
CS2424FP90	38	1 1/2"	-24	1 1/2"	-24	105	188	88	63,5		415	6000
CS2432FP90	38	1 1/2"	-24	2"	-32	105	188	93	79,4		415	6000
CS3232FP90	51	2"	-32	2"	-32	140	237	123	79,4		345	5000

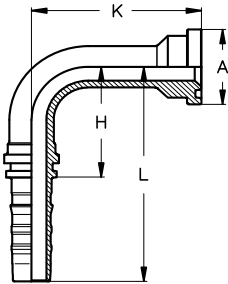
FP90
LONG DROP
SAE CODE 62 FLANGE - 90° ELBOW - LONG DROP
FLANGIA SAE CODE 62 - CURVA A 90° - LUNGA
SFS90
LONG DROP

TIEFFE Part.N.	Hose Size			Flange Size Connection		Dimensions (mm)					Maximum W.P.	
	DN	Inch	Dash	Inch	Dash	H	L	K	A		bar	PSI
CS1212FP90-K100	19	3/4"	-12	3/4"	-12	55	106	100	41,3		420	6000
CS1216FP90-K140	19	3/4"	-12	1"	-16	55	106	140	47,6		420	6000
CS1616FP90-K120	25	1"	-16	1"	-16	71	128	120	47,6		415	6000
CS2020FP90-K120	31,5	1 1/4"	-20	1 1/4"	-20	87	154	120	54		415	6000

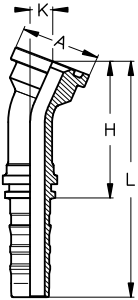
FP22
SAE CODE 62 FLANGE - 22,5° ELBOW
FLANGIA SAE CODE 62 - CURVA A 22,5°
SFS22,5

TIEFFE Part.N.	Hose Size			Flange Size Connection		Dimensions (mm)					Maximum W.P.	
	DN	Inch	Dash	Inch	Dash	H	L	K	A		bar	PSI
CS1212FP22	19	3/4"	-12	3/4"	-12	74	125	13	41,3		420	6000
CS1216FP22	19	3/4"	-12	1"	-16	76	127	14	47,6		420	6000
CS1616FP22	25	1"	-16	1"	-16	89	145	13	47,6		415	6000
CS1620FP22	25	1"	-16	1 1/4"	-20	89	145	13	54		415	6000
CS2020FP22	31,5	1 1/4"	-20	1 1/4"	-20	103	169	15	54		415	6000
CS2024FP22	31,5	1 1/4"	-20	1 1/2"	-24	104	171	15	63,5		415	6000
CS2424FP22	38	1 1/2"	-24	1 1/2"	-24	123	206	17	63,5		415	6000
CS2432FP22	38	1 1/2"	-24	2"	-32	127	210	19	79,4		415	6000
CS3232FP22	51	2"	-32	2"	-32	166	263	24	79,4		345	5000

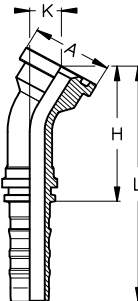
FP30
SAE CODE 62 FLANGE - 30° ELBOW
FLANGIA SAE CODE 62 - CURVA A 30°
SFS30

TIEFFE Part.N.	Hose Size			Flange Size Connection		Dimensions (mm)					Maximum W.P.	
	DN	Inch	Dash	Inch	Dash	H	L	K	A		bar	PSI
CS1212FP30	19	3/4"	-12	3/4"	-12	72	123	18	41,3		420	6000
CS1216FP30	19	3/4"	-12	1"	-16	74	125	19	47,6		420	6000
CS1616FP30	25	1"	-16	1"	-16	87	143	19	47,6		415	6000
CS1620FP30	25	1"	-16	1 1/4"	-20	87	143	19	54		415	6000
CS2020FP30	31,5	1 1/4"	-20	1 1/4"	-20	100	167	20	54		415	6000
CS2024FP30	31,5	1 1/4"	-20	1 1/2"	-24	102	168	21	63,5		415	6000
CS2424FP30	38	1 1/2"	-24	1 1/2"	-24	121	203	24	63,5		415	6000
CS2432FP30	38	1 1/2"	-24	2"	-32	124	207	26	79,4		415	6000
CS3232FP30	51	2"	-32	2"	-32	162	259	34	79,4		345	5000

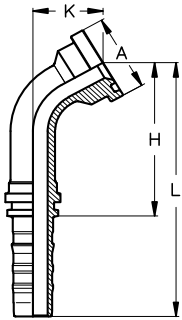
FP60

SAE CODE 62 FLANGE - 60° ELBOW
FLANGIA SAE CODE 62 - CURVA A 60°
SFS60

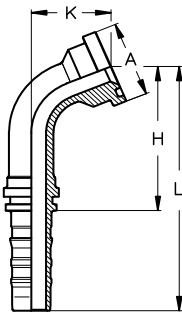
TIEFFE Part.N.	Hose Size			Flange Size Connection		Dimensions (mm)					Maximum W.P.	
	DN	Inch	Dash	Inch	Dash	H	L	K	A		bar	PSI
CS1212FP60	19	3/4"	-12	3/4"	-12	79	130	38	41,3		420	6000
CS1216FP60	19	3/4"	-12	1"	-16	80	131	40	47,6		420	6000
CS1616FP60	25	1"	-16	1"	-16	99	155	42	47,6		415	6000
CS1620FP60	25	1"	-16	1 1/4"	-20	99	155	42	54		415	6000
CS2020FP60	31,5	1 1/4"	-20	1 1/4"	-20	119	185	47	54		415	6000
CS2024FP60	31,5	1 1/4"	-20	1 1/2"	-24	120	186	49	63,5		415	6000
CS2424FP60	38	1 1/2"	-24	1 1/2"	-24	143	225	56	63,5		415	6000
CS2432FP60	38	1 1/2"	-24	2"	-32	145	228	60	79,4		415	6000
CS3232FP60	51	2"	-32	2"	-32	193	289	79	79,4		345	5000

FP67

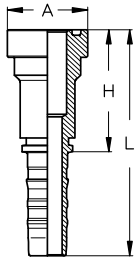
SAE CODE 62 FLANGE - 67,5° ELBOW
FLANGIA SAE CODE 62 - CURVA A 67,5°
SFS67,5

TIEFFE Part.N.	Hose Size			Flange Size Connection		Dimensions (mm)					Maximum W.P.	
	DN	Inch	Dash	Inch	Dash	H	L	K	A		bar	PSI
CS1212FP67	19	3/4"	-12	3/4"	-12	74	125	43	41,3		420	6000
CS1216FP67	19	3/4"	-12	1"	-16	75	126	45	47,6		420	6000
CS1616FP67	25	1"	-16	1"	-16	93	150	48	47,6		415	6000
CS1620FP67	25	1"	-16	1 1/4"	-20	93	150	48	54		415	6000
CS2020FP67	31,5	1 1/4"	-20	1 1/4"	-20	112	179	54	54		415	6000
CS2024FP67	31,5	1 1/4"	-20	1 1/2"	-24	113	180	56	63,5		415	6000
CS2424FP67	38	1 1/2"	-24	1 1/2"	-24	135	217	65	63,5		415	6000
CS2432FP67	38	1 1/2"	-24	2"	-32	137	219	69	79,4		415	6000
CS3232FP67	51	2"	-32	2"	-32	182	278	90	79,4		345	5000

YP

"SUPERCAT" FLANGE
FLANGIA "SUPERCAT"

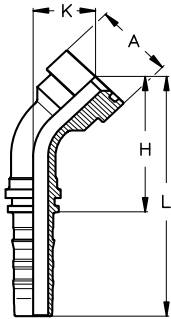
SFS
SUPERCAT

TIEFFE Part.N.	Hose Size			Flange Size Connection		Dimensions (mm)					Maximum W.P.	
	DN	Inch	Dash	Inch	Dash	H	L	A			bar	PSI
CS1212YP	19	3/4"	-12	3/4"	-12	84	135	41,3			420	6000
CS1216YP	19	3/4"	-12	1"	-16	84	135	47,6			420	6000
CS1616YP	25	1"	-16	1"	-16	90	146,5	47,6			415	6000
CS1620YP	25	1"	-16	1 1/4"	-20	90	146,5	54			415	6000
CS2020YP	31,5	1 1/4"	-20	1 1/4"	-20	88	154,4	54			415	6000
CS2024YP	31,5	1 1/4"	-20	1 1/2"	-24	88	154,5	63,5			415	6000
CS2424YP	38	1 1/2"	-24	1 1/2"	-24	84	166,5	63,5			415	6000
CS2432YP	38	1 1/2"	-24	2"	-32	110	192,5	79,4			415	6000
CS3232YP	51	2"	-32	2"	-32	130	226,5	79,4			345	5000

YP45

"SUPERCAT" FLANGE - 45° ELBOW
FLANGIA "SUPERCAT" - CURVA A 45°

SFS45
SUPERCAT

TIEFFE Part.N.	Hose Size			Flange Size Connection		Dimensions (mm)					Maximum W.P.	
	DN	Inch	Dash	Inch	Dash	H	L	K	A		bar	PSI
CS1212YP45	19	3/4"	-12	3/4"	-12	72	123	34	41,3		420	6000
CS1216YP45	19	3/4"	-12	1"	-16	74	125	36	47,6		420	6000
CS1616YP45	25	1"	-16	1"	-16	86	143	36	47,6		415	6000
CS1620YP45	25	1"	-16	1 1/4"	-20	86	143	36	54		415	6000
CS2020YP45	31,5	1 1/4"	-20	1 1/4"	-20	96	162	36	54		415	6000
CS2024YP45	31,5	1 1/4"	-20	1 1/2"	-24	96	162	36	63,5		415	6000
CS2424YP45	38	1 1/2"	-24	1 1/2"	-24	114	196	41	63,5		415	6000
CS2432YP45	38	1 1/2"	-24	2"	-32	116	199	44	79,4		415	6000
CS3232YP45	51	2"	-32	2"	-32	152	250	57	79,4		345	5000

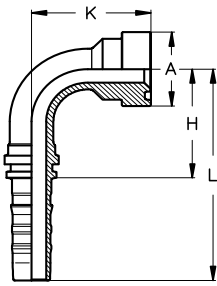
YP90
"SUPERCAT" FLANGE - 90° ELBOW
 FLANGIA "SUPERCAT" - CURVA A 90°

SFS90
 SUPERCAT

TIEFFE Part.N.	Hose Size			Flange Size Connection		Dimensions (mm)					Maximum W.P.	
	DN	Inch	Dash	Inch	Dash	H	L	K	A		bar	PSI
CS1212YP90	19	3/4"	-12	3/4"	-12	55	106	64	41,3		420	6000
CS1216YP90	19	3/4"	-12	1"	-16	55	106	64	47,6		420	6000
CS1616YP90	25	1"	-16	1"	-16	71	128	73	47,6		415	6000
CS1620YP90	25	1"	-16	1 1/4"	-20	71	128	73	54		415	6000
CS2020YP90	31,5	1 1/4"	-20	1 1/4"	-20	87	154	77	54		415	6000
CS2024YP90	31,5	1 1/4"	-20	1 1/2"	-24	87	154	78	63,5		415	6000
CS2424YP90	38	1 1/2"	-24	1 1/2"	-24	105	188	90	63,5		415	6000
CS2432YP90	38	1 1/2"	-24	2"	-32	105	188	94	79,4		415	6000
CS3232YP90	51	2"	-32	2"	-32	140	237	125	79,4		345	5000

YP90

LONG DROP

"SUPERCAT" FLANGE - 90° ELBOW - LONG DROP
 FLANGIA "SUPERCAT" - CURVA A 90° - LUNGA

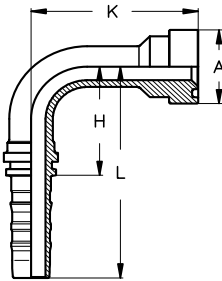
SFS90
 SUPERCAT
 LONG DROP

TIEFFE Part.N.	Hose Size			Flange Size Connection		Dimensions (mm)					Maximum W.P.	
	DN	Inch	Dash	Inch	Dash	H	L	K	A		bar	PSI
CS1212YP90-K129	19	3/4"	-12	3/4"	-12	55	106	129	41,3		420	6000
CS1616YP90-K132	25	1"	-16	1"	-16	71	128	132	47,6		415	6000
CS1616YP90-K150	25	1"	-16	1"	-16	71	128	150	47,6		415	6000
CS2020YP90-K150	31,5	1 1/4"	-20	1 1/4"	-20	87	154	150	54		415	6000
CS2024YP90-K135	31,5	1 1/4"	-20	1 1/2"	-24	87	154	135	63,5		415	6000
CS2424YP90-K106	38	1 1/2"	24	1 1/2"	-24	105	188	106	63,5		415	6000

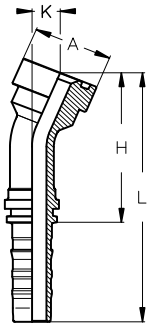
YP22

"SUPERCAT" FLANGE - 22,5° ELBOW
 FLANGIA "SUPERCAT" - CURVA A 22,5°

SFS22,5
 SUPERCAT

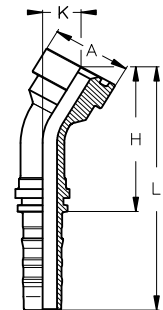
TIEFFE Part.N.	Hose Size			Flange Size Connection		Dimensions (mm)					Maximum W.P.	
	DN	Inch	Dash	Inch	Dash	H	L	K	A		bar	PSI
CS1212YP22	19	3/4"	-12	3/4"	-12	82	133	16	41,3		420	6000
CS1216YP22	19	3/4"	-12	1"	-16	84	135	17	47,6		420	6000
CS1616YP22	25	1"	-16	1"	-16	97	153	17	47,6		415	6000
CS1620YP22	25	1"	-16	1 1/4"	-20	97	153	17	54		415	6000
CS2020YP22	31,5	1 1/4"	-20	1 1/4"	-20	406	172	16	54		415	6000
CS2024YP22	31,5	1 1/4"	-20	1 1/2"	-24	406	174	16	63,5		415	6000
CS2424YP22	38	1 1/2"	-24	1 1/2"	-24	125	208	18	63,5		415	6000
CS2432YP22	38	1 1/2"	-24	2"	-32	129	211	19	79,4		415	6000
CS3232YP22	51	2"	-32	2"	-32	168	265	25	79,4		345	5000

YP30

"SUPERCAT" FLANGE - 30° ELBOW
 FLANGIA "SUPERCAT" - CURVA A 30°

SFS30
 SUPERCAT

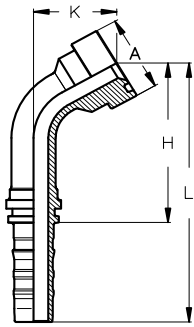
TIEFFE Part.N.	Hose Size			Flange Size Connection		Dimensions (mm)					Maximum W.P.	
	DN	Inch	Dash	Inch	Dash	H	L	K	A		bar	PSI
CS1212YP30	19	3/4"	-12	3/4"	-12	79	130	22	41,3		420	6000
CS1216YP30	19	3/4"	-12	1"	-16	82	133	23	47,6		420	6000
CS1616YP30	25	1"	-16	1"	-16	94	151	23	47,6		415	6000
CS1620YP30	25	1"	-16	1 1/4"	-20	94	151	23	54		415	6000
CS2020YP30	31,5	1 1/4"	-20	1 1/4"	-20	103	170	22	54		415	6000
CS2024YP30	31,5	1 1/4"	-20	1 1/2"	-24	104	170	23	63,5		415	6000
CS2424YP30	38	1 1/2"	-24	1 1/2"	-24	123	205	25	63,5		415	6000
CS2432YP30	38	1 1/2"	-24	2"	-32	126	208	27	79,4		415	6000
CS3232YP30	51	2"	-32	2"	-32	164	264	35	79,4		345	5000

YP60

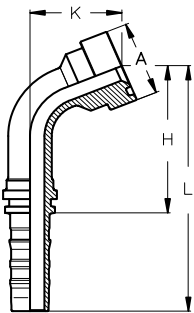
"SUPERCAT" FLANGE - 60° ELBOW
FLANGIA "SUPERCAT" - CURVA A 60°
SFS60
SUPERCAT

TIEFFE Part.N.	Hose Size			Flange Size Connection		Dimensions (mm)					Maximum W.P.	
	DN	Inch	Dash	Inch	Dash	H	L	K	A		bar	PSI
CS1212YP60	19	3/4"	-12	3/4"	-12	83	134	45	41,3		420	6000
CS1216YP60	19	3/4"	-12	1"	-16	85	136	48	47,6		420	6000
CS1616YP60	25	1"	-16	1"	-16	103	160	50	47,6		415	6000
CS1620YP60	25	1"	-16	1 1/4"	-20	103	160	50	54		415	6000
CS2020YP60	31,5	1 1/4"	-20	1 1/4"	-20	121	187	50	54		415	6000
CS2024YP60	31,5	1 1/4"	-20	1 1/2"	-24	121	187	51	63,5		415	6000
CS2424YP60	38	1 1/2"	-24	1 1/2"	-24	144	226	58	63,5		415	6000
CS2432YP60	38	1 1/2"	-24	2"	-32	146	228	61	79,4		415	6000
CS3232YP60	51	2"	-32	2"	-32	194	290	81	79,4		345	5000

YP67

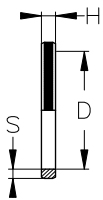
"SUPERCAT" FLANGE - 67,5° ELBOW
FLANGIA "SUPERCAT" - CURVA A 67,5°
SFS67,5
SUPERCAT

TIEFFE Part.N.	Hose Size			Flange Size Connection		Dimensions (mm)					Maximum W.P.	
	DN	Inch	Dash	Inch	Dash	H	L	K	A		bar	PSI
CS1212YP67	19	3/4"	-12	3/4"	-12	77	128	50	41,3		420	6000
CS1216YP67	19	3/4"	-12	1"	-16	79	130	53	47,6		420	6000
CS1616YP67	25	1"	-16	1"	-16	97	153	56	47,6		415	6000
CS1620YP67	25	1"	-16	1 1/4"	-20	97	153	56	54		415	6000
CS2020YP67	31,5	1 1/4"	-20	1 1/4"	-20	114	181	57	54		415	6000
CS2024YP67	31,5	1 1/4"	-20	1 1/2"	-24	114	181	58	63,5		415	6000
CS2424YP67	38	1 1/2"	-24	1 1/2"	-24	137	219	66	63,5		415	6000
CS2432YP67	38	1 1/2"	-24	2"	-32	138	220	69	79,4		415	6000
CS3232YP67	51	2"	-32	2"	-32	184	280	92	79,4		345	5000

D'RING SEAL FOR "SUPERCAT" FLANGES
GUARNIZIONI D'RING PER FLANGE "SUPERCAT"

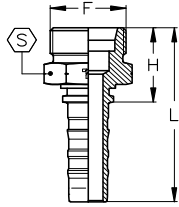
TIEFFE Part.N.	Flange Connection		Dimensions (mm)		
	Inch	Dash	D	H	S
DR12	3/4"	-12	25,4	5	3,5
DR16	1"	-16	31,8	5	3,5
DR20	1 1/4"	-20	38,1	5	3,5
DR24	1 1/2"	-24	44,5	5	3,5
DR32	2"	-32	63,9	5	3,5

MM-S
METRIC MALE - 24° CONE SEAT - HEAVY DUTY
MASCHIO METRICO - SVASATO 24° - SERIE PESANTE
CES

TIEFFE Part.N.	Hose Size			METRIC 24° Connection		Dimensions (mm)					Maximum W.P.	
	DN	Inch	Dash	F	Pipe	H	L	S			bar	PSI
CS12MM20S	19	3/4"	-12	M30x2	20S	34	85	30			420	6000
CS12MM25S	19	3/4"	-12	M36x2	25S	38	89	36			420	6000
CS16MM25S	25	1"	-16	M36x2	25S	40	97	36			380	5500
CS16MM30S	25	1"	-16	M42x2	30S	44	101	46			380	5500
CS20MM30S	31,5	1 1/4"	-20	M42x2	30S	47	113	46			325	4700
CS20MM38S	31,5	1 1/4"	-24	M52x2	38S	51	117	55			325	4700
CS24MM38S	38	1 1/2"	-24	M52x2	38S	53	135	55			290	4200

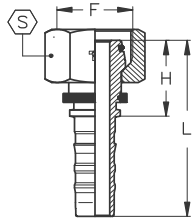
FOS-S
METRIC FEMALE 24° O'RING CONE - HEAVY DUTY - SLIP-ON NUT
FEMMINA METRICA OGIVA 24° O'RING - SERIE PESANTE - DADO LIBERO
DKOS

TIEFFE Part.N.	Hose Size			METRIC 24° Connection		Dimensions (mm)					Maximum W.P.	
	DN	Inch	Dash	F	Pipe	H	L	S	O-RING		bar	PSI
CS12FOS20S	19	3/4"	-12	M30x2	20S	37	88	36	16,3x2,4		420	6000
CS12FOS25S	19	3/4"	-12	M36x2	25S	39	90	46	20,3x2,4		420	6000
CS16FOS25S	25	1"	-16	M36x2	25S	41	97	46	22x2		380	5500
CS16FOS30S	25	1"	-16	M42x2	30S	42	98	50	25,3x2,4		380	5500
CS20FOS30S	31,5	1 1/4"	-20	M42x2	30S	43	109	50	25,3x2,4		325	4700
CS20FOS38S	31,5	1 1/4"	-20	M52x2	38S	48	115	60	33,3x2,4		325	4700
CS24FOS38S	38	1 1/2"	-24	M52x2	38S	51	133	60	33,3x2,4		290	4200

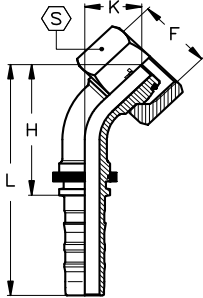
FOS-S45
METRIC FEMALE 24° O'RING CONE - 45° ELBOW - HEAVY DUTY - SLIP-ON NUT
FEMMINA METRICA OGIVA 24° O'RING - CURVA A 45° - SERIE PESANTE - DADO LIBERO
DKOS45

TIEFFE Part.N.	Hose Size			METRIC 24° Connection		Dimensions (mm)					Maximum W.P.	
	DN	Inch	Dash	F	Pipe	H	L	K	S	O-RING	bar	PSI
CS12FOS20S45	19	3/4"	-12	M30x2	20S	65	116	27	36	16,3x2,4	420	6000
CS12FOS25S45	19	3/4"	-12	M36x2	25S	66	117	28	46	20,3x2,4	420	6000
CS16FOS25S45	25	1"	-16	M36x2	25S	83	140	34	46	22x2	380	5500
CS16FOS30S45	25	1"	-16	M42x2	30S	82	138	32	50	25,3x2,4	380	5500
CS20FOS30S45	31,5	1 1/4"	-20	M42x2	30S	100	166	40	50	25,3x2,4	325	4700
CS20FOS38S45	31,5	1 1/4"	-20	M52x2	38S	97	164	38	60	33,3x2,4	325	4700
CS24FOS38S45	38	1 1/2"	-24	M52x2	38S	121	203	48	60	33,3x2,4	290	4200

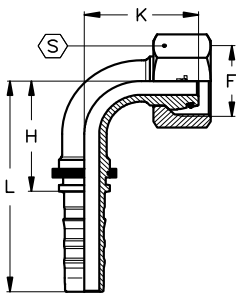
FOS-S90
METRIC FEMALE 24° O'RING CONE - 90° ELBOW - HEAVY DUTY - SLIP-ON NUT
FEMMINA METRICA OGIVA 24° O'RING - CURVA A 90° - SERIE PESANTE - DADO LIBERO
DKOS90

TIEFFE Part.N.	Hose Size			METRIC 24° Connection		Dimensions (mm)					Maximum W.P.	
	DN	Inch	Dash	F	Pipe	H	L	K	S	O-RING	bar	PSI
CS12FOS20S90	19	3/4"	-12	M30x2	20S	55	106	55	36	16,3x2,4	420	6000
CS12FOS25S90	19	3/4"	-12	M36x2	25S	55	106	55	46	20,3x2,4	420	6000
CS16FOS25S90	25	1"	-16	M36x2	25S	71	128	69	46	22x2	380	5500
CS16FOS30S90	25	1"	-16	M42x2	30S	71	128	67	50	25,3x2,4	380	5500
CS20FOS30S90	31,5	1 1/4"	-20	M42x2	30S	87	154	83	50	25,3x2,4	325	4700
CS20FOS38S90	31,5	1 1/4"	-20	M52x2	38S	87	154	80	60	33,3x2,4	325	4700
CS24FOS38S90	38	1 1/2"	-24	M52x2	38S	105	188	100	60	33,3x2,4	290	4200

NO-SKIVE

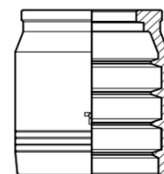

NO-SKIVE

BSN4

RUBBER HOSES STEEL WIRE SPIRAL - TUBI GOMMA SPIRALATI ACCIAIO

Hose Size			ISO 3862 4SP			ISO 3862 4SH			ISO 3862 R12 SAE100 R12			ISO 3862 R13 SAE100 R13			ISO 3862 R15 SAE100 R15						Collapse control mandrel Spina controllo collasso	
			Ferrule Boccola	Skiving length Lungh. di pelatura	Ø Swage (Ref.) Ø Press. (Rif.)	Ferrule Boccola	Skiving length Lungh. di pelatura	Ø Swage (Ref.) Ø Press. (Rif.)	Ferrule Boccola	Skiving length Lungh. di pelatura	Ø Swage (Ref.) Ø Press. (Rif.)	Ferrule Boccola	Skiving length Lungh. di pelatura	Ø Swage (Ref.) Ø Press. (Rif.)	Ferrule Boccola	Skiving length Lungh. di pelatura	Ø Swage (Ref.) Ø Press. (Rif.)	Ferrule Boccola	Skiving length Lungh. di pelatura	Ø Swage (Ref.) Ø Press. (Rif.)		
DN	Inch	Dash	Part.N.	mm	mm	Part.N.	mm	mm	Part.N.	mm	mm	Part.N.	mm	mm	Part.N.	mm	mm	Part.N.	mm	mm	Part.N.	
19	3/4"	-12	BSN412	no-skive	35,9	BSN412	no-skive	35,9	BSN412	no-skive	34,6	BSN412	no-skive	35,8	BSN412	no-skive	35,8					SCS12
25	1"	-16	BSN416	no-skive	43	BSN416	no-skive	42,1	BSN416	no-skive	41,5	BSN416	no-skive	42,2	BSN416	no-skive	42,1					SCS16
31,5	1 1/4"	-20				BSN420	no-skive	50,6	BSN420	no-skive	51,9											SCS20
38	1 1/2"	-24				BSN424	no-skive	60	BSN424	no-skive	60											SCS24
51	2"	-32				BSN432	no-skive	73,8	BSN432	no-skive	72,5											SCS32

OUTSIDE
SKIVE

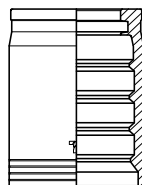

BSS4

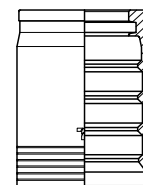



BSS6

OUTSIDE
SKIVE



RUBBER HOSES STEEL WIRE SPIRAL - TUBI GOMMA SPIRALATI ACCIAIO

Hose Size			ISO 3862 4SP			ISO 3862 4SH			ISO 3862 R12 SAE100 R12			ISO 3862 R13 SAE100 R13			ISO 3862 R15 SAE100 R15			Collapse control mandrel Spina controllo collasso			
			Ferrule Boccola	Skiving length Lungh. di pelatura	Ø Swage (Ref.) Ø Press. (Rif.)	Ferrule Boccola	Skiving length Lungh. di pelatura	Ø Swage (Ref.) Ø Press. (Rif.)	Ferrule Boccola	Skiving length Lungh. di pelatura	Ø Swage (Ref.) Ø Press. (Rif.)	Ferrule Boccola	Skiving length Lungh. di pelatura	Ø Swage (Ref.) Ø Press. (Rif.)	Ferrule Boccola	Skiving length Lungh. di pelatura	Ø Swage (Ref.) Ø Press. (Rif.)				
DN	Inch	Dash	Part.N.	mm	mm	Part.N.	mm	mm	Part.N.	mm	mm	Part.N.	mm	mm	Part.N.	mm	mm				Part.N.
19	3/4"	-12	BSS412	41,5	32,5	BSS412	41,5	32,7	BSS412	41,5	32,1	BSS412	41,5	33,2	BSS412	41,5	33,2				SCS12
25	1"	-16	BSS416	44,5	40,4	BSS416	44,5	40,3	BSS416	44,5	40,1	BSS416	44,5	40,8	BSS416	44,5	40,8				SCS16
31,5	1 1/4"	-20	BSS620	53	50,7	BSS420	52,5	46,4	BSS420	52,5	48	BSS620	53	51,3	BSS620	53	51,3				SCS20
38	1 1/2"	-24	BSS624	69	59,4	BSS424	68,5	57,4	BSS424	68,5	56	BSS624	69	60,8	BSS624	69	60,8				SCS24
51	2"	-32	BSS632	78	73,6	BSS432	78	68,8	BSS432	78	69,1	BSS632	78	75,7							SCS32



FERRULES

REFERENCE	DESCRIPTION	PAGE	REFERENCE	DESCRIPTION	PAGE
BHH	 <p>DOUBLE SKIVE FERRULE FOR SPIRAL HOSES BOCCOLA PER TUBI SPIRALATI CON DOPPIA PELATURA</p>	113	BH13	 <p>DOUBLE SKIVE FERRULE FOR SPIRAL HOSES BOCCOLA PER TUBI SPIRALATI CON DOPPIA PELATURA</p>	113

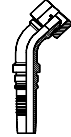
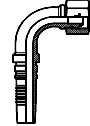

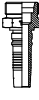
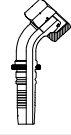

BRITISH STANDARD CONNECTIONS

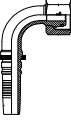
REFERENCE	DESCRIPTION	PAGE	REFERENCE	DESCRIPTION	PAGE
CH-MGC	 <p>BSP TAPERED MALE 60° CONE SEAT MASCHIO GAS CONICO SVASATO 60°</p>	114	CH-FGSO	 <p>BSP FEMALE 60° O'RING CONE TIEFFE NUT BS 5200 - ISO 12151-6 FEMMINA GAS OGIVA 60° O-RING DADO TIEFFE BS 5200 - ISO 12151-6</p>	115
CH-MG	 <p>BSP PARALLEL MALE 60° CONE SEAT BS 5200 - ISO 12151-6 MASCHIO GAS CILINDRICO SVASATO 60° BS 5200 - ISO 12151-6</p>	114	CH-FGSO45B	 <p>BSP FEMALE 60° O RING CONE 45° ELBOW - TIEFFE NUT BS 5200 - ISO 12151-6 FEMMINA GAS OGIVA 60° O-RING CURVA A 45° - DADO TIEFFE BS 5200 - ISO 12151-6</p>	115
			CH-FGSO90B	 <p>BSP FEMALE 60° O RING CONE 90° ELBOW - TIEFFE NUT BS 5200 - ISO 12151-6 FEMMINA GAS OGIVA 60° O-RING CURVA A 90° - DADO TIEFFE BS 5200 - ISO 12151-6</p>	115



DIN STANDARD CONNECTIONS (DIN20066 / ISO12151-2)

REFERENCE	DESCRIPTION	PAGE	REFERENCE	DESCRIPTION	PAGE
CH-MM	 <p>METRIC MALE 24° CONE SEAT MASCHIO METRICO SVASATO 24°</p>	116	CH-FOS45	 <p>METRIC FEMALE 24° O'RING CONE 45° ELBOW - SLIP-ON NUT FEMM. METR. OGIVA 24° O'RING CURVA A 45° - DADO LIBERO</p>	117
CH-FOS	 <p>METRIC FEMALE 24° O'RING CONE SLIP-ON NUT FEMMINA METRICA OGIVA 24° O'RING DADO LIBERO</p>	116	CH-FOS90	 <p>METRIC FEMALE 24° O'RING CONE 90° ELBOW - SLIP-ON NUT FEMM. METR. OGIVA 24° O'RING CURVA A 90° - DADO LIBERO</p>	117

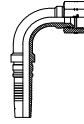

AMERICAN STANDARD CONNECTIONS - NPTF - JIC 37° (SAE J516 / ISO 12151-5)

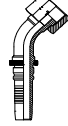
REFERENCE	DESCRIPTION	PAGE	REFERENCE	DESCRIPTION	PAGE
CH-NPT	 NPTF MALE 60° CONE SEAT SAE J516 MASCHIO NPTF SVASATO 60° SAE J516	118	CH-FIS	 JIC FEMALE 37° CONE SEAT TIEFFE NUT SAE J516 - ISO 12151-5 FEMMINA JIC SVASATA 37° DADO TIEFFE SAE J516 - ISO 12151-5	119
CH-MI	 JIC MALE 37° CONE SAE J516 - ISO 12151-5 MASCHIO JIC CONO 37° SAE J516 - ISO 12151-5	118	CH-FIS45B	 JIC FEMALE 37° CONE SEAT 45° ELBOW - TIEFFE NUT SAE J516 - ISO 12151-5 FEMMINA JIC SVASATA 37° CURVA A 45° - DADO TIEFFE SAE J516 - ISO 12151-5	119
			CH-FIS90B	 JIC FEMALE 37° CONE SEAT 90° ELBOW - TIEFFE NUT SAE J516 - ISO 12151-5 FEMMINA JIC SVASATA 37° CURVA A 90° - DADO TIEFFE SAE J516 - ISO 12151-5	119

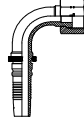
AMERICAN STANDARD CONNECTIONS - ORFS (SAE J516 / ISO 12151-1)

REFERENCE	DESCRIPTION	PAGE	REFERENCE	DESCRIPTION	PAGE
CH-MRS	 ORFS MALE MASCHIO ORFS	120	CH-FRS45B	 ORFS FEMALE 45° ELBOW - SLIP-ON NUT FEMMINA ORFS CURVA A 45° - DADO LIBERO	120
CH-FRS	 ORFS FEMALE SLIP-ON NUT FEMMINA ORFS DADO LIBERO	120	CH-FRS90B	 ORFS FEMALE 90° ELBOW - SLIP-ON NUT FEMMINA ORFS CURVA A 90° - DADO LIBERO	120

AMERICAN STANDARD CONNECTIONS - FLANGE CODE 61 (SAE J516 / ISO 12151-3)

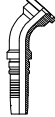
REFERENCE	DESCRIPTION	PAGE	REFERENCE	DESCRIPTION	PAGE
CH-FLB	 <p>SAE CODE 61 FLANGE FLANGIA SAE CODE 61</p>	121	CH-FL90B	 <p>SAE CODE 61 FLANGE 90° ELBOW FLANGIA SAE CODE 61 CURVA A 90°</p>	121
CH-FL45B	 <p>SAE CODE 61 FLANGE 45° ELBOW FLANGIA SAE CODE 61 CURVA A 45°</p>	121			

AMERICAN STANDARD CONNECTIONS - FLANGE CODE 62 (SAE J516 / ISO 12151-3)

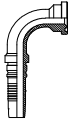
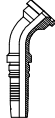
REFERENCE	DESCRIPTION	PAGE	REFERENCE	DESCRIPTION	PAGE
CH-FPB	 <p>SAE CODE 62 FLANGE FLANGIA SAE CODE 62</p>	122	CH-FP90B	 <p>SAE CODE 62 FLANGE 90° ELBOW FLANGIA SAE CODE 62 CURVA A 90°</p>	122
CH-FP45B	 <p>SAE CODE 62 FLANGE 45° ELBOW FLANGIA SAE CODE 62 CURVA A 45°</p>	122			

OEM CONNECTIONS - "SUPERCAT" FLANGE

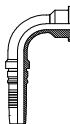
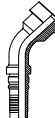
REFERENCE	DESCRIPTION	PAGE	REFERENCE	DESCRIPTION	PAGE
CH-YP	 <p>"SUPERCAT" FLANGE FLANGIA "SUPERCAT"</p>	123	CH-YP90	 <p>"SUPERCAT" FLANGE 90° ELBOW FLANGIA "SUPERCAT" CURVA A 90°</p>	123
CH-YP45	 <p>"SUPERCAT" FLANGE 45° ELBOW FLANGIA "SUPERCAT" CURVA A 45°</p>	123			

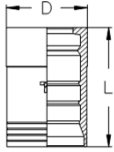
BHH

DOUBLE SKIVE FERRULE (INTERLOCK)
BOCCOLA A DOPPIA PELATURA (INTERLOCK)

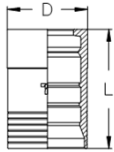
TIEFFE Part.N.	Hose Size			Dimensions (mm)		Applications Applicazioni					
	DN	Inch	Dash	D	L						
BHH12	19	3/4"	-12	38	60	4SP	4SH	R13	R15		
BHH16	25	1"	-16	46	74,5	4SP	4SH	R13	R15		
BHH20	31,5	1 1/4"	-20	55	88	4SP	4SH				
BHH24	38	1 1/2"	-24	62	94		4SH				
BHH32	51	2"	-32	78,5	99		4SH				

BH13

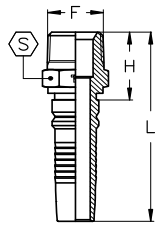
DOUBLE SKIVE FERRULE (INTERLOCK)
BOCCOLA A DOPPIA PELATURA (INTERLOCK)

TIEFFE Part.N.	Hose I.D. ∅ int. Tubo			Dimensions (mm)		Applications Applicazioni					
	DN	dash	Inch	D	L						
BH1320	31,5	1 1/4"	-20	59,8	88			R13	R15		
BH1324	38	1 1/2"	-24	67	94			R13			
BH1332	51	2"	-32	84,5	99			R13			

MGC

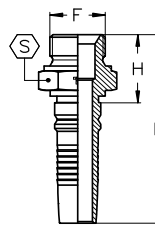
BSP TAPERED MALE 60° CONE SEAT
MASCHIO GAS CONICO SVASATO 60°
AGR-K

TIEFFE Part.N.	Hose Size			BSP Connection Size		Dimensions (mm)						Maximum W.P.	
	DN	Inch	Dash	F	Dash	H	L	S				bar	PSI
CH1212MGC	19	3/4"	-12	3/4"-14	-12	34	96	27				280	4000
CH1616MGC	25	1"	-16	1"-11	-16	40	113	36				280	4000
CH2020MGC	31,5	1 1/4"	-20	1 1/4"-11	-20	47	135	46				210	3000
CH2424MGC	38	1 1/2"	-24	1 1/2"-11	-24	48	142	50				185	2700
CH3232MGC	51	2"	-32	2"-11	-32	57	155	65				175	2500

MG

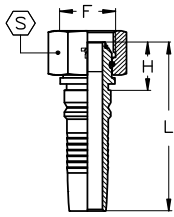
BSP PARALLEL MALE 60° CONE SEAT
MASCHIO GAS CILINDRICO SVASATO 60°
AGR

TIEFFE Part.N.	Hose Size			BSP Connection Size		Dimensions (mm)						Maximum W.P.	
	DN	Inch	Dash	F	Dash	H	L	S				bar	PSI
CH1212MG	19	3/4"	-12	3/4"-14	-12	35	97	32				420	6000
CH1616MG	25	1"	-16	1"-11	-16	41	114	41				380	5500
CH1620MG	25	1"	-16	1 1/4"-11	-20	44	117	50				325	4700
CH2020MG	31,5	1 1/4"	-20	1 1/4"-11	-20	46	134	50				325	4700
CH2424MG	38	1 1/2"	-24	1 1/2"-11	-24	49	143	55				290	4200
CH3232MG	51	2"	-32	2"-11	-32	56	154	70				250	3600

FGSO
BSP FEMALE 60° O-RING CONE - TIEFFE NUT
FEMMINA GAS OGIVA 60° O-RING - DADO TIEFFE
DKOR

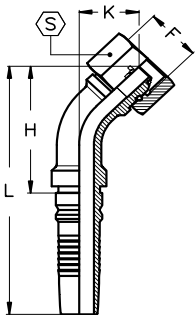
TIEFFE Part.N.	Hose Size			BSP Connection Size		Dimensions (mm)					Maximum W.P.	
	DN	Inch	Dash	F	Dash	H	L	S	O-RING	bar	PSI	
CH1212FGSO	19	3/4"	-12	3/4"-14	-12	25	87	32	16x1,5	420	6000	
CH1616FGSO	25	1"	-16	1"-11	-16	30	103	41	22x1,5	380	5500	
CH1620FGSO	25	1"	-16	1 1/4"-11	-20	33	106	50	28,3x1,78	325	4700	
CH2020FGSO	31,5	1 1/4"	-20	1 1/4"-11	-20	35	122	50	28,3x1,78	325	4700	
CH2424FGSO	38	1 1/2"	-24	1 1/2"-11	-24	36	130	60	33,05x1,78	290	4200	
CH3232FGSO	51	2"	-32	2"-11	-32	40	138	75	44,17x1,78	250	3600	

FGSO45
BSP FEMALE 60° O-RING CONE - 45° ELBOW - TIEFFE NUT
FEMMINA GAS OGIVA 60° O-RING - CURVA A 45° - DADO TIEFFE
DKOR45

TIEFFE Part.N.	Hose Size			BSP Connection Size		Dimensions (mm)					Maximum W.P.	
	DN	Inch	Dash	F	Dash	H	L	K	S	O-RING	bar	PSI
CH1212FGSO45B	19	3/4"	-12	3/4"-14	-12	68	130	32	32	16x1,5	420	6000
CH1616FGSO45B	25	1"	-16	1"-11	-16	86	159	39	41	22x1,5	380	5500
CH1620FGSO45B	25	1"	-16	1 1/4"-11	-20	88	161	41	50	28,3x1,78	325	4700
CH2020FGSO45B	31,5	1 1/4"	-20	1 1/4"-11	-20	107	195	47	50	28,3x1,78	325	4700
CH2424FGSO45B	38	1 1/2"	-24	1 1/2"-11	-24	126	220	55	60	33,05x1,78	290	4200
CH3232FGSO45B	51	2"	-32	2"-11	-32	160	258	66	75	44,17x1,78	250	3600

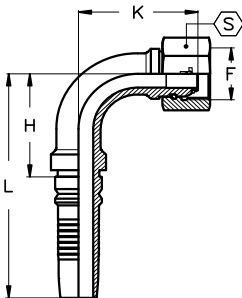
FGSO90
BSP FEMALE 60° O-RING CONE - 90° ELBOW - TIEFFE NUT
FEMMINA GAS OGIVA 60° O-RING - CURVA A 90° - DADO TIEFFE
DKOR90

TIEFFE Part.N.	Hose Size			BSP Connection Size		Dimensions (mm)					Maximum W.P.	
	DN	Inch	Dash	F	Dash	H	L	K	S	O-RING	bar	PSI
CH1212FGSO90B	19	3/4"	-12	3/4"-14	-12	55	117	63	32	16x1,5	420	6000
CH1616FGSO90B	25	1"	-16	1"-11	-16	71	144	79	41	22x1,5	380	5500
CH1620FGSO90B	25	1"	-16	1 1/4"-11	-20	71	144	81	50	28,3x1,78	325	4700
CH2020FGSO90B	31,5	1 1/4"	-20	1 1/4"-11	-20	90	177	96	50	28,3x1,78	325	4700
CH2424FGSO90B	38	1 1/2"	-24	1 1/2"-11	-24	107	201	113	60	33,05x1,78	290	4200
CH3232FGSO90B	51	2"	-32	2"-11	-32	142	240	140	75	44,17x1,78	250	3600

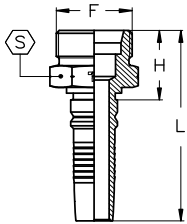
MM-S

METRIC MALE - 24° CONE SEAT - HEAVY DUTY
MASCHIO METRICO - SVASATO 24° - SERIE PESANTE
CES

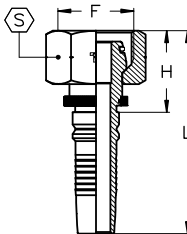
TIEFFE Part.N.	Hose Size			METRIC 24° Connection		Dimensions (mm)					Maximum W.P.	
	DN	Inch	Dash	F	Pipe	H	L	S			bar	PSI
CH12MM20S	19	3/4"	-12	M 30x2	20S	31	93	30			420	6000
CH12MM25S	19	3/4"	-12	M 36x2	25S	35	97	36			420	6000
CH16MM25S	25	1"	-16	M 36x2	25S	36	109	36			380	5500
CH16MM30S	25	1"	-16	M 42x2	30S	40	113	46			380	5500
CH20MM30S	31,5	1 1/4"	-20	M 42x2	30S	42	130	46			325	4700
CH20MM38S	31,5	1 1/4"	-20	M 52x2	38S	46	134	55			325	4700
CH24MM38S	38	1 1/2"	-24	M 52x2	38S	47	141	55			290	4200

FOS-S

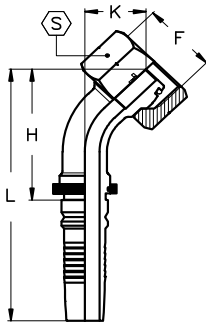
METRIC FEMALE 24° O'RING CONE - HEAVY DUTY - SLIP-ON NUT
FEMMINA METRICA OGIVA 24° O'RING - SERIE PESANTE - DADO LIBERO
DKOS

TIEFFE Part.N.	Hose Size			METRIC 24° Connection		Dimensions (mm)					Maximum W.P.	
	DN	Inch	Dash	F	Pipe	H	L	S		O-RING	bar	PSI
CH12FOS20S	19	3/4"	-12	M 30x2	20S	33	95	36		16,3x2,4	420	6000
CH12FOS25S	19	3/4"	-12	M 36x2	25S	36	98	41		20,3x2,4	420	6000
CH16FOS25S	25	1"	-16	M 36x2	25S	37	110	41		22x2	380	5500
CH16FOS30S	25	1"	-16	M 42x2	30S	39	112	50		25,3x2,4	380	5500
CH20FOS30S	31,5	1 1/4"	-20	M 42x2	30S	41	128	50		25,3x2,4	325	4700
CH20FOS38S	31,5	1 1/4"	-20	M 52x2	38S	43	131	60		33,3x2,4	325	4700
CH24FOS38S	38	1 1/2"	-24	M 52x2	38S	44	138	60		33,3x2,4	290	4200

FOS-S45
METRIC FEMALE 24° O'RING CONE - 45° ELBOW - HEAVY DUTY - SLIP-ON NUT
FEMMINA METRICA OGIVA 24° O'RING - CURVA A 45° - SERIE PESANTE - DADO LIBERO
DKOS45

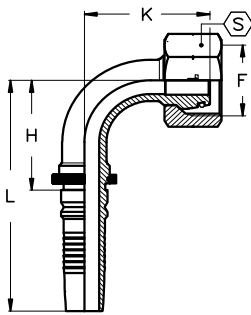
TIEFFE Part.N.	Hose Size			METRIC 24° Connection		Dimensions (mm)					Maximum W.P.	
	DN	Inch	Dash	F	Pipe	H	L	K	S	O-RING	bar	PSI
CH12FOS20S45B	19	3/4"	-12	M 30x2	20S	67	129	29	36	16,3x2,4	420	6000
CH12FOS25S45B	19	3/4"	-12	M 36x2	25S	66	128	30	46	20,3x2,4	420	6000
CH16FOS25S45B	25	1"	-16	M 36x2	25S	81	154	33	46	22x2	380	5500
CH16FOS30S45B	25	1"	-16	M 42x2	30S	81	154	33	50	25,3x2,4	380	5500
CH20FOS30S45B	31,5	1 1/4"	-20	M 42x2	30S	99	187	39	50	25,3x2,4	325	4700
CH20FOS38S45B	31,5	1 1/4"	-20	M 52x2	38S	100	188	40	60	33,3x2,4	325	4700
CH24FOS38S45B	38	1 1/2"	-24	M 52x2	38S	116	210	44	60	33,3x2,4	290	4200

FOS-S90
METRIC FEMALE 24° O'RING CONE - 90° ELBOW - HEAVY DUTY - SLIP-ON NUT
FEMMINA METRICA OGIVA 24° O'RING - CURVA A 90° - SERIE PESANTE - DADO LIBERO
DKOS90

TIEFFE Part.N.	Hose Size			METRIC 24° Connection		Dimensions (mm)					Maximum W.P.	
	DN	Inch	Dash	F	Pipe	H	L	K	S	O-RING	bar	PSI
CH12FOS20S90B	19	3/4"	-12	M 30x2	20S	55	117	60	36	16,3x2,4	420	6000
CH12FOS25S90B	19	3/4"	-12	M 36x2	25S	55	117	60	46	20,3x2,4	420	6000
CH16FOS25S90B	25	1"	-16	M 36x2	25S	71	144	71	46	22x2	380	5500
CH16FOS30S90B	25	1"	-16	M 42x2	30S	71	144	71	50	25,3x2,4	380	5500
CH20FOS30S90B	31,5	1 1/4"	-20	M 42x2	30S	90	177	85	50	25,3x2,4	325	4700
CH20FOS38S90B	31,5	1 1/4"	-20	M 52x2	38S	90	177	86	60	33,3x2,4	325	4700
CH24FOS38S90B	38	1 1/2"	-24	M 52x2	38S	107	201	98	60	33,3x2,4	290	4200

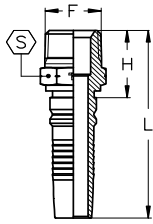
NPT
NPTF MALE 60° CONE SEAT
MASCHIO NPTF SVASATO 60°
AGN

TIEFFE Part.N.	Hose Size			NPTF Connection Size		Dimensions (mm)						Maximum W.P.	
	DN	Inch	Dash	F	Dash	H	L	S				bar	PSI
CH1212NPT	19	3/4"	-12	3/4"-14	-12	34	98	27				280	4000
CH1216NPT	19	3/4"	-12	1"-11,5	-16	42	103	36				280	4000
CH1616NPT	25	1"	-16	1"-11,5	-16	42	115	36				280	4000
CH1620NPT	25	1"	-16	1 1/4"-11,5	-20	45	118	46				210	3000
CH2020NPT	31,5	1 1/4"	-20	1 1/4"-11,5	-20	47	135	46				210	3000
CH2024NPT	31,5	1 1/4"	-20	1 1/2"-11,5	-24	50	137	50				185	2700
CH2424NPT	38	1 1/2"	-24	1 1/2"-11,5	-24	50	144	50				185	2700
CH3232NPT	51	2"	-32	2"-11,5	-35	55	153	60				175	2500

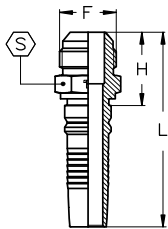
MI
JIC MALE 37° CONE
MASCHIO JIC CONO 37°
AGJ

TIEFFE Part.N.	Hose Size			JIC 37° Connection Size		Dimensions (mm)						Maximum W.P.	
	DN	Inch	Dash	F	Dash	H	L	S				bar	PSI
CH1212MI	19	3/4"	-12	1 1/16"-12	-12	38	99	27				350	5000
CH1214MI	19	3/4"	-12	1 3/16"-12	-14	39	101	32				280	4000
CH1216MI	19	3/4"	-12	1 5/16"-12	-16	41	102	36				280	4000
CH1616MI	25	1"	-16	1 5/16"-12	-16	42	114	36				280	4000
CH1620MI	25	1"	-16	1 5/8"-12	-20	45	117	46				210	3000
CH2020MI	31,5	1 1/4"	-20	1 5/8"-12	-20	47	134	46				210	3000
CH2024MI	31,5	1 1/4"	-20	1 7/8"-12	-24	51	139	50				185	2700
CH2424MI	38	1 1/2"	-24	1 7/8"-12	-24	52	145	50				185	2700
CH3232MI	51	2"	-32	2 1/2"-12	-32	63	160	65				175	2500

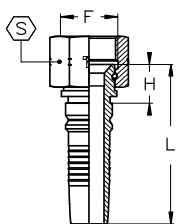
FIS
JIC FEMALE 37° CONE SEAT - TIEFFE NUT
FEMMINA JIC SVASATA 37° - DADO TIEFFE
DKJ

TIEFFE Part.N.	Hose Size			JIC 37° Connection Size		Dimensions (mm)						Maximum W.P.	
	DN	Inch	Dash	F	Dash	H	L	S				bar	PSI
CH1212FIS	19	3/4"	-12	1 1/16"-12	-12	20	82	32				350	5000
CH1214FIS	19	3/4"	-12	1 3/16"-12	-14	21,5	83	36				280	4000
CH1216FIS	19	3/4"	-12	1 5/16"-12	-16	22,5	84	41				280	4000
CH1616FIS	25	1"	-16	1 5/16"-12	-16	23,5	96	41				280	4000
CH1620FIS	25	1"	-16	1 5/8"-12	-20	28	101	50				210	3000
CH2020FIS	31,5	1 1/4"	-20	1 5/8"-12	-20	29	117	50				210	3000
CH2024FIS	31,5	1 1/4"	-20	1 7/8"-12	-24	29,5	117	60				185	2700
CH2424FIS	38	1 1/2"	-24	1 7/8"-12	-24	30	124	60				185	2700
CH3232FIS	51	2"	-32	2 1/2"-12	-32	37	135	75				175	2500

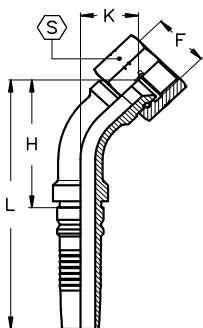
FIS45
JIC FEMALE 37° CONE SEAT - 45° ELBOW - TIEFFE NUT
FEMMINA JIC SVASATA 37° - CURVA A 45° - DADO TIEFFE
DKJ45

TIEFFE Part.N.	Hose Size			JIC 37° Connection Size		Dimensions (mm)						Maximum W.P.	
	DN	Inch	Dash	F	Dash	H	L	K	S			bar	PSI
CH1212FIS45B	19	3/4"	-12	1 1/16"-12	-12	64	126	28	32			350	5000
CH1214FIS45B	19	3/4"	-12	1 3/16"-12	-14	65	127	29	36			280	4000
CH1216FIS45B	19	3/4"	-12	1 5/16"-12	-16	68	130	32	41			280	4000
CH1616FIS45B	25	1"	-16	1 5/16"-12	-16	82	155	35	41			280	4000
CH1620FIS45B	25	1"	-16	1 5/8"-12	-20	84	157	37	50			210	3000
CH2020FIS45B	31	1 1/4"	-20	1 5/8"-12	-20	103	191	43	50			210	3000
CH2024FIS45B	31	1 1/4"	-20	1 7/8"-12	-24	103	191	43	60			185	2700
CH2424FIS45B	38	1 1/2"	-24	1 7/8"-12	-24	121	215	50	60			185	2700
CH3232FIS45B	51	2"	-32	2 1/2"-12	-32	158	256	65	75			175	2500

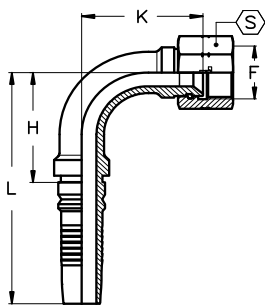
FIS90
JIC FEMALE 37° CONE SEAT - 90° ELBOW - TIEFFE NUT
FEMMINA JIC SVASATA 37° - CURVA A 90° - DADO TIEFFE
DKJ90

TIEFFE Part.N.	Hose Size			JIC 37° Connection Size		Dimensions (mm)						Maximum W.P.	
	DN	Inch	Dash	F	Dash	H	L	K	S			bar	PSI
CH1212FIS90B	19	3/4"	-12	1 1/16"-12	-12	55	117	58	32			350	5000
CH1214FIS90B	19	3/4"	-12	1 3/16"-12	-14	55	117	59	36			280	4000
CH1216FIS90B	19	3/4"	-12	1 5/16"-12	-16	55	117	63	41			280	4000
CH1616FIS90B	25	1"	-16	1 5/16"-12	-16	71	144	73	41			280	4000
CH1620FIS90B	25	1"	-16	1 5/8"-12	-20	71	144	76	50			210	3000
CH2020FIS90B	31	1 1/4"	-20	1 5/8"-12	-20	90	177	91	50			210	3000
CH2024FIS90B	31	1 1/4"	-20	1 7/8"-12	-24	90	177	91	60			185	2700
CH2424FIS90B	38	1 1/2"	-24	1 7/8"-12	-24	107	201	106	60			185	2700
CH3232FIS90B	51	2"	-32	2 1/2"-12	-32	140	240	139	75			175	2500

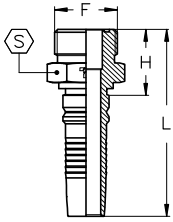
MRS

ORFS MALE
MASCHIO ORFS

AG ORFS

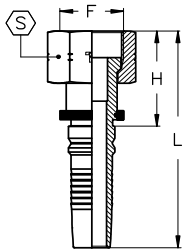
TIEFFE Part.N.	Hose Size			ORFS Connection Size		Dimensions (mm)					Maximum W.P.	
	DN	Inch	Dash	F	Dash	H	L	S	O-RING	bar	PSI	
CH1212MRS	19	3/4"	-12	1 3/16"-12	-12	34	95	32		18,77x1,78	420	6000
CH1616MRS	25	1"	-16	1 7/16"-12	-16	37	110	41		23,52x1,78	415	6000
CH2020MRS	31,5	1 1/4"	-20	1 11/16"-12	-20	40	128	46		29,87x1,78	345	5000
CH2424MRS	38	1 1/2"	-24	2"-12	-24	43	136	55		37,82x1,78	250	4200

FRS

ORFS FEMALE - SLIP-ON NUT
FEMMINA ORFS - DADO LIBERO

DK ORFS

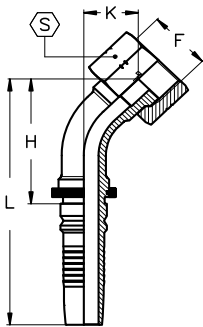
TIEFFE Part.N.	Hose Size			ORFS Connection Size		Dimensions (mm)					Maximum W.P.	
	DN	Inch	Dash	F	Dash	H	L	S			bar	PSI
CH1212FRS	19	3/4"	-12	1 3/16"-12	-12	35	97	36			420	6000
CH1616FRS	25	1"	-16	1 7/16"-12	-16	37	110	41			415	6000
CH2020FRS	31,5	1 1/4"	-20	1 11/16"-12	-20	38	126	50			345	5000
CH2424FRS	38	1 1/2"	-24	2"-12	-24	39	132	60			290	4200

FRS45

ORFS FEMALE - 45° ELBOW - SLIP-ON NUT
FEMMINA ORFS - CURVA A 45° - DADO LIBERO

DK ORFS 45

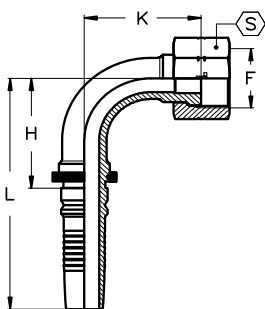
TIEFFE Part.N.	Hose Size			ORFS Connection Size		Dimensions (mm)					Maximum W.P.	
	DN	Inch	Dash	F	Dash	H	L	K	S		bar	PSI
CH1212FRS45B	19	3/4"	-12	1 3/16"-12	-12	63	125	26	36		420	6000
CH1616FRS45B	25	1"	-16	1 7/16"-12	-16	78	151	31	41		415	6000
CH2020FRS45B	31,5	1 1/4"	-20	1 11/16"-12	-20	96	184	36	50		345	5000
CH2424FRS45B	38	1 1/2"	-24	2"-12	-24	113	207	42	60		290	4200

FRS90

ORFS FEMALE - 90° ELBOW - SLIP-ON NUT
FEMMINA ORFS - CURVA A 90° - DADO LIBERO

DK ORFS 90

TIEFFE Part.N.	Hose Size			ORFS Connection Size		Dimensions (mm)					Maximum W.P.	
	DN	Inch	Dash	F	Dash	H	L	K	S		bar	PSI
CH1212FRS90B	19	3/4"	-12	1 3/16"-12	-12	56	118	55	36		420	6000
CH1616FRS90B	25	1"	-16	1 7/16"-12	-16	71	144	67	41		415	6000
CH2020FRS90B	31,5	1 1/4"	-20	1 11/16"-12	-20	90	177	81	50		345	5000
CH2424FRS90B	38	1 1/2"	-24	2"-12	-24	107	201	95	60		290	4200

FLB	SAE CODE 61 FLANGE FLANGIA SAE CODE 61											SFL	
	TIEFFE Part.N.	Hose Size			Flange Size Connection		Dimensions (mm)					Maximum W.P.	
		DN	Inch	Dash	Inch	Dash	H	L	A			bar	PSI
	CH1212FLB	19	3/4"	-12	3/4"	-12	52	113	38			350	5000
	CH1216FLB	19	3/4"	-12	1"	-16	58	119	44,5			350	5000
	CH1612FLB	25	1"	-16	3/4"	-12	53	125	38			350	5000
	CH1616FLB	25	1"	-16	1"	-16	59	131	44,5			350	5000
	CH1620FLB	25	1"	-16	1 1/4"	-20	63	135	51			280	4000
	CH2020FLB	31,5	1 1/4"	-20	1 1/4"	-20	64	151	51			280	4000
	CH2024FLB	31,5	1 1/4"	-20	1 1/2"	-24	69	156	60,3			210	3000
	CH2424FLB	38	1 1/2"	-24	1 1/2"	-24	69	163	60,3			210	3000
	CH2432FLB	38	1 1/2"	-24	2"	-32	74	168	71,5			210	3000
	CH3232FLB	51	2"	-32	2"	-32	76	173	71,5			210	3000

FL45B	SAE CODE 61 FLANGE - 45° ELBOW FLANGIA SAE CODE 61 - CURVA A 45°											SFL45	
	TIEFFE Part.N.	Hose Size			Flange Size Connection		Dimensions (mm)					Maximum W.P.	
		DN	Inch	Dash	Inch	Dash	H	L	K	A		bar	PSI
	CH1212FL45B	19	3/4"	-12	3/4"	-12	63	125	27	38		350	5000
	CH1216FL45B	19	3/4"	-12	1"	-16	67	129	31	44,5		350	5000
	CH1612FL45B	25	1"	-16	3/4"	-12	78	151	31	38		350	5000
	CH1616FL45B	25	1"	-16	1"	-16	79	152	32	44,5		350	5000
	CH1620FL45B	25	1"	-16	1 1/4"	-20	80	153	33	51		280	4000
	CH2020FL45B	31,5	1 1/4"	-20	1 1/4"	-20	99	187	39	51		280	4000
	CH2024FL45B	31,5	1 1/4"	-20	1 1/2"	-24	99	187	39	60,3		210	3000
	CH2424FL45B	38	1 1/2"	-24	1 1/2"	-24	117	211	46	60,3		210	3000
	CH2432FL45B	38	1 1/2"	-24	2"	-32	118	212	47	71,5		210	3000
	CH3232FL45B	51	2"	-32	2"	-32	152	250	58	71,5		210	3000

FL90B	SAE CODE 61 FLANGE - 90° ELBOW FLANGIA SAE CODE 61 - CURVA A 90°											SFL90	
	TIEFFE Part.N.	Hose Size			Flange Size Connection		Dimensions (mm)					Maximum W.P.	
		DN	Inch	Dash	Inch	Dash	H	L	K	A		bar	PSI
	CH1212FL90B	19	3/4"	-12	3/4"	-12	56	118	56	38		350	5000
	CH1216FL90B	19	3/4"	-12	1"	-16	56	118	61	44,5		350	5000
	CH1612FL90B	25	1"	-16	3/4"	-12	72	145	67	38		350	5000
	CH1616FL90B	25	1"	-16	1"	-16	72	145	68	44,5		350	5000
	CH1620FL90B	25	1"	-16	1 1/4"	-20	72	145	70	51		280	4000
	CH2020FL90B	31,5	1 1/4"	-20	1 1/4"	-20	91	178	85	51		280	4000
	CH2024FL90B	31,5	1 1/4"	-20	1 1/2"	-24	91	178	85	60,3		210	3000
	CH2424FL90B	38	1 1/2"	-24	1 1/2"	-24	108	202	100	60,3		210	3000
	CH2432FL90B	38	1 1/2"	-24	2"	-32	108	202	102	71,5		210	3000
	CH3232FL90B	51	2"	-32	2"	-32	143	281	129	71,5		210	3000

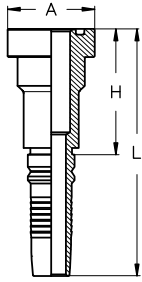
YPB

"SUPERCAT" FLANGE
FLANGIA "SUPERCAT"

SFS
SUPERCAT

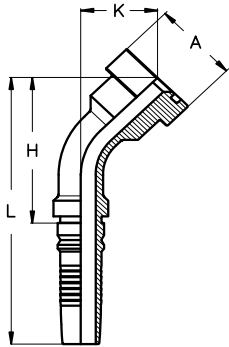
TIEFFE Part.N.	Hose Size			Flange Size Connection		Dimensions (mm)					Maximum W.P.	
	DN	Inch	Dash	Inch	Dash	H	L	A	O-RING	bar	PSI	
CH1212YPB	19	3/4"	-12	3/4"	-12	64	126	41,3		24,99x3,53	420	6000
CH1216YPB	19	3/4"	-12	1"	-16	65	127	47,6		32,92x3,53	420	6000
CH1616YPB	25	1"	-16	1"	-16	69	142	47,6		32,92x3,53	420	6000
CH1620YPB	25	1"	-16	1 1/4"	-20	72	145	54		37,69x3,53	420	6000
CH2020YPB	31,5	1 1/4"	-20	1 1/4"	-20	73	161	54		37,69x3,53	420	6000
CH2024YPB	31,5	1 1/4"	-20	1 1/2"	-24	80	168	63,5		47,22x3,53	420	6000
CH2424YPB	38	1 1/2"	-24	1 1/2"	-24	81	175	63,5		47,22x3,53	350	5000

YP45B

"SUPERCAT" FLANGE - 45° ELBOW
FLANGIA "SUPERCAT" - CURVA A 45°

SFS45
SUPERCAT

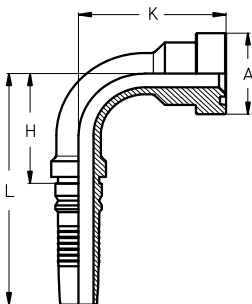
TIEFFE Part.N.	Hose Size			Flange Size Connection		Dimensions (mm)					Maximum W.P.	
	DN	Inch	Dash	Inch	Dash	H	L	K	A	O-RING	bar	PSI
CH1212YP45B	19	3/4"	-12	3/4"	-12	73	135	37	41,3	24,99x3,53	420	6000
CH1216YP45B	19	3/4"	-12	1"	-16	76	137	39	47,6	32,92x3,53	420	6000
CH1616YP45B	25	1"	-16	1"	-16	87	160	40	47,6	32,92x3,53	420	6000
CH1620YP45B	25	1"	-16	1 1/4"	-20	88	161	41	54	37,69x3,53	420	6000
CH2020YP45B	31,5	1 1/4"	-20	1 1/4"	-20	102	189	42	54	37,69x3,53	420	6000
CH2024YP45B	31,5	1 1/4"	-20	1 1/2"	-24	108	196	48	63,5	47,22x3,53	420	6000
CH2424YP45B	38	1 1/2"	-24	1 1/2"	-24	120	214	49	63,5	47,22x3,53	350	5000

YP90B

"SUPERCAT" FLANGE - 90° ELBOW
FLANGIA "SUPERCAT" - CURVA A 90°

SFS90
SUPERCAT

TIEFFE Part.N.	Hose Size			Flange Size Connection		Dimensions (mm)					Maximum W.P.	
	DN	Inch	Dash	Inch	Dash	H	L	K	A	O-RING	bar	PSI
CH1212YP90B	19	3/4"	-12	3/4"	-12	55	117	70	41,3	24,99x3,53	420	6000
CH1216YP90B	19	3/4"	-12	1"	-16	55	117	73	47,6	32,92x3,53	420	6000
CH1616YP90B	25	1"	-16	1"	-16	71	144	79	47,6	32,92x3,53	420	6000
CH1620YP90B	25	1"	-16	1 1/4"	-20	71	144	82	54	37,69x3,53	420	6000
CH2020YP90B	31,5	1 1/4"	-20	1 1/4"	-20	90	177	89	54	37,69x3,53	420	6000
CH2024YP90B	31,5	1 1/4"	-20	1 1/2"	-24	90	177	97	63,5	47,22x3,53	420	6000
CH2424YP90B	38	1 1/2"	-24	1 1/2"	-24	107	201	105	63,5	47,22x3,53	350	5000

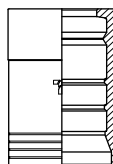
DOUBLE
SKIVE



BHH

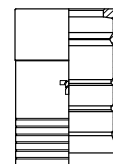

BH13







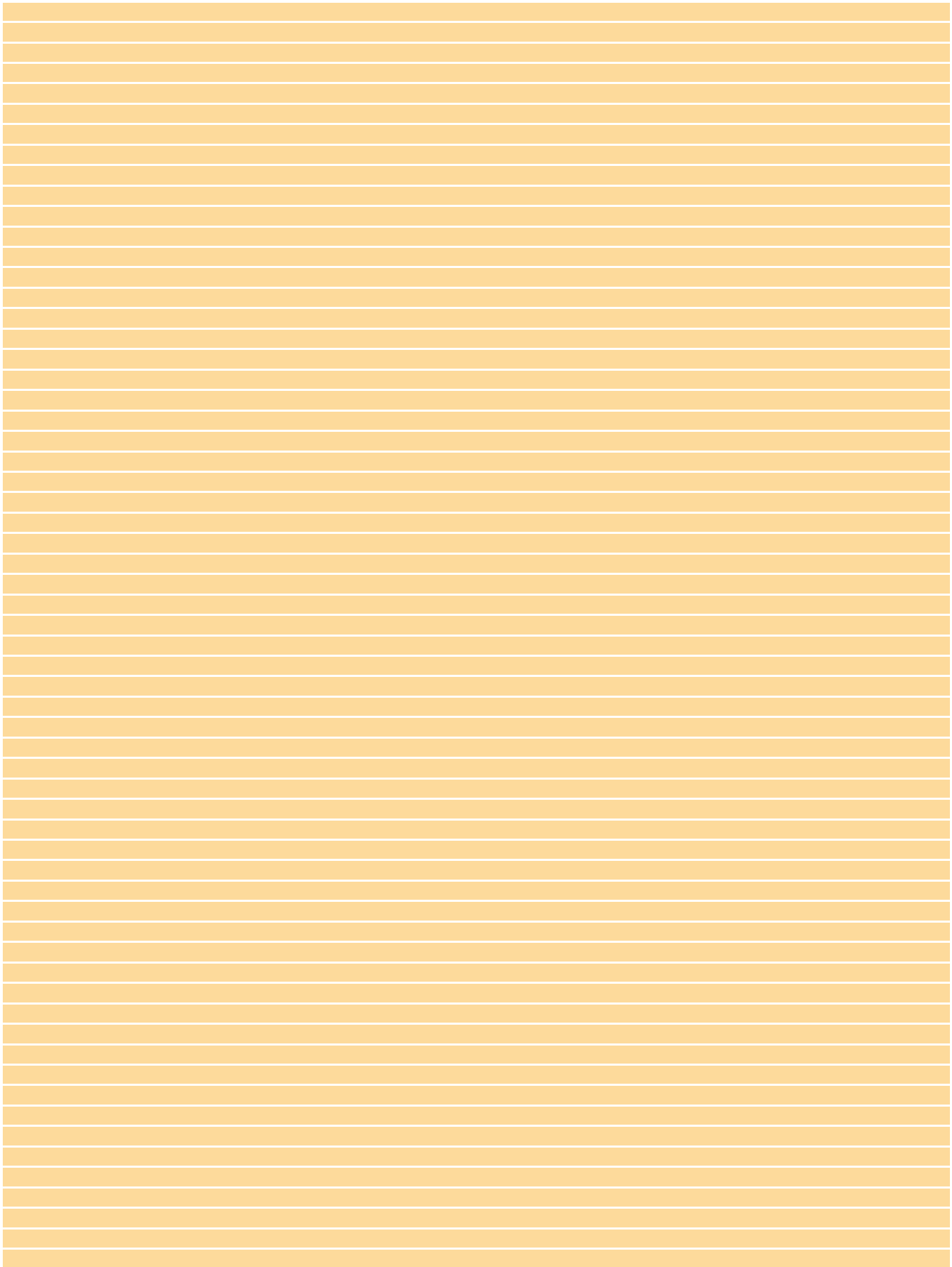





DOUBLE
SKIVE

RUBBER HOSES STEEL WIRE SPIRAL - TUBI GOMMA SPIRALATI ACCIAIO

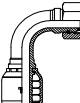
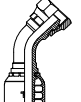

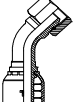
Hose Size			ISO 3862 4SP				ISO 3862 4SH			ISO 3862 R13 SAE100 R13			ISO 3862 R15 SAE100 R15			Collapse control mandrel <i>Spina controllo collasso</i>			
			Ferrule <i>Boccola</i>	Skiving length <i>Lungh.di pelatura</i>		Ø Swage (Ref.) Ø Press. (Rif.)	Ferrule <i>Boccola</i>	Skiving length <i>Lungh.di pelatura</i>		Ferrule <i>Boccola</i>	Skiving length <i>Lungh.di pelatura</i>		Ferrule <i>Boccola</i>	Skiving length <i>Lungh.di pelatura</i>			Ø Swage (Ref.) Ø Press. (Rif.)		
				Inside <i>Interna</i>	Outside <i>Esterna</i>			Inside <i>Interna</i>	Outside <i>Esterna</i>		Inside <i>Interna</i>	Outside <i>Esterna</i>		Inside <i>Interna</i>	Outside <i>Esterna</i>				
DN	Inch	Dash	Part.N.	mm	mm	mm	Part.N.	mm	mm	mm	Part.N.	mm	mm	mm	mm	mm	mm	Part.N.	
19	3/4"	-12	BHH12	15	48	34,2	BHH12	15	48	34,1	BHH12	15	48	33,7	BHH12	15	48	33,3	SCH12
25	1"	-16	BHH16	17,5	61	40,9	BHH16	17,5	61	41,5	BHH16	17,5	61	41,5	BHH16	17,5	61	41,7	SCH16
31,5	1 1/4"	-20					BHH20	22,5	71	50,5	BH1320	22,5	71	53,8	BH1320	22,5	71	54,5	SCH20
38	1 1/2"	-24					BHH24	22,5	79	58	BH1324	22,5	79	60,5					SCH24
51	2"	-32					BHH32	30	83	74,2	BH1332	30	83	77,9					SCH32

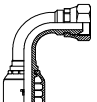

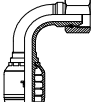



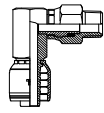

BRITISH STANDARD CONNECTIONS

REFERENCE	DESCRIPTION	PAGE	REFERENCE	DESCRIPTION	PAGE
HX-MGC	 <p>BSP TAPERED MALE 60° CONE SEAT MASCHIO GAS CONICO SVASATO 60°</p>	133	HX-FGP90K	 <p>BSP FEMALE 60° CONE 90° COMPACT ELBOW CRIMPED-BACK NUT BS 5200 - ISO 12151-6 FEMMINA GAS OGIVA 60° CURVA COMPATTA 90° - DADO PRESSATO BS 5200 - ISO 12151-6</p>	138
HX-MG	 <p>BSP PARALLEL MALE 60° CONE SEAT BS 5200 - ISO 12151-6 MASCHIO GAS CILINDRICO SVASATO 60° BS 5200 - ISO 12151-6</p>	134	HX-FGOL HX-FGOS	 <p>BSP FEMALE 60° O'RING CONE FULL EXAGON NUT BS 5200 - ISO 12151-6 FEMMINA GAS OGIVA 60° O'RING DADO TUTTO ESAGONO BS 5200 - ISO 12151-6</p>	139
HX-FGP	 <p>BSP FEMALE 60° CONE CRIMPED-BACK NUT BS 5200 - ISO 12151-6 FEMMINA GAS - OGIVA 60° DADO PRESSATO BS 5200 - ISO 12151-6</p>	135	HX-FGOL45 HX-FGOS45	 <p>BSP FEMALE 60° O RING CONE 45° ELBOW - FULL EXAGON NUT BS 5200 - ISO 12151-6 FEMMINA GAS OGIVA 60° O-RING CURVA A 45° - DADO TUTTO ESAGONO BS 5200 - ISO 12151-6</p>	140
HX-FGL HX-FGS	 <p>BSP FEMALE 60° CONE FULL EXAGON NUT BS 5200 - ISO 12151-6 FEMMINA GAS OGIVA 60° DADO TUTTO ESAGONO BS 5200 - ISO 12151-6</p>	135	HX-FGOL90 HX-FGOS90	 <p>BSP FEMALE 60° O RING CONE 90° ELBOW - FULL EXAGON NUT BS 5200 - ISO 12151-6 FEMMINA GAS OGIVA 60° O-RING CURVA A 90° - DADO TUTTO ESAGONO BS 5200 - ISO 12151-6</p>	140
HX-FGP45	 <p>BSP FEMALE 60° CONE 45° ELBOW - CRIMPED-BACK NUT BS 5200 - ISO 12151-6 FEMMINA GAS OGIVA 60° CURVA A 45° - DADO PRESSATO BS 5200 - ISO 12151-6</p>	136	HX-MGF	 <p>BSP PARALLEL MALE FLAT SEAT MASCHIO GAS CILINDRICO SEDE PIANA</p>	141
HX-FGL45 HX-FGS45	 <p>BSP FEMALE 60° CONE 45° ELBOW - FULL EXAGON NUT BS 5200 - ISO 12151-6 FEMMINA GAS OGIVA 60° CURVA A 45° - DADO TUTTO ESAGONO BS 5200 - ISO 12151-6</p>	136	HX-FGF	 <p>BSP FEMALE FLAT SEAT CRIMPED-BACK NUT FEMMINA GAS SEDE PIANA DADO PRESSATO</p>	141
HX-FGP90	 <p>BSP FEMALE 60° CONE 90° ELBOW - CRIMPED-BACK NUT BS 5200 - ISO 12151-6 FEMMINA GAS OGIVA 60° CURVA A 90° - DADO PRESSATO BS 5200 - ISO 12151-6</p>	137	HX-OG	 <p>BSP BANJO OCCHIO GAS</p>	142
HX-FGL90 HX-FGS90	 <p>BSP FEMALE 60° CONE 90° ELBOW - FULL EXAGON NUT BS 5200 - ISO 12151-6 FEMMINA GAS OGIVA 60° CURVA A 90° - DADO TUTTO ESAGONO BS 5200 - ISO 12151-6</p>	137			

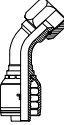

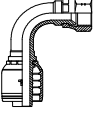
AMERICAN STANDARD CONNECTIONS - NPTF - NPSM

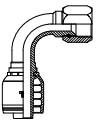
REFERENCE	DESCRIPTION	PAGE	REFERENCE	DESCRIPTION	PAGE
HX-NPT	 <p>NPTF MALE 60° CONE SEAT SAE J516 MASCHIO NPTF SVASATO 60° SAE J516</p>	143	HX-SPT	 <p>NPTF SWIVEL MALE 60° CONE SEAT MASCHIO GIREVOLE NPTF SVASATO 60°</p>	144
HX-FSM	 <p>NPSM FEMALE 60° CONE FEMMINA NPSM OGOVA 60°</p>	143	HX-SPT90	 <p>NPTF SWIVEL MALE 60° CONE SEAT 90° COMPACT ELBOW MASCHIO GIREVOLE NPTF SVASATO 60° CURVA 90° COMPATTA</p>	144

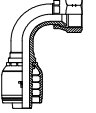
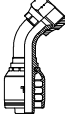
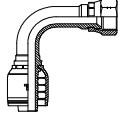

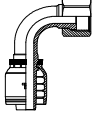
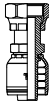
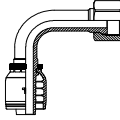

AMERICAN STANDARD CONNECTIONS - JIC 37° (SAE J516 / ISO 12151-5)

REFERENCE	DESCRIPTION	PAGE	REFERENCE	DESCRIPTION	PAGE
HX-MI	 <p>JIC MALE 37° CONE MASCHIO JIC CONO 37°</p>	145	HX-FIS45	 <p>JIC FEMALE 37° CONE SEAT 45° ELBOW - TIEFFE NUT FEMMINA JIC SVASATA 37° CURVA A 45° - DADO TIEFFE</p>	148
HX-FIP	 <p>JIC FEMALE 37° CONE SEAT CRIMPED-BACK NUT FEMMINA JIC SVASATA 37° DADO PRESSATO</p>	146	HX-FIP90	 <p>JIC FEMALE 37° CONE SEAT 90° ELBOW - CRIMPED-BACK NUT FEMMINA JIC SVASATA 37° CURVA A 90° - DADO PRESSATO</p>	149
HX-FICP	 <p>JIC FEMALE 37° CONE SEAT DOUBLE EXAGON - CRIMPED-BACK NUT FEMMINA JIC SVASATA 37° DOPPIO ESAGONO - DADO PRESSATO</p>	147	HX-FIS90	 <p>JIC FEMALE 37° CONE SEAT 90° ELBOW - TIEFFE NUT FEMMINA JIC SVASATA 37° CURVA A 90° - DADO TIEFFE</p>	149
HX-FICS	 <p>JIC FEMALE 37° CONE SEAT DOUBLE EXAGON - TIEFFE NUT FEMMINA JIC SVASATA 37° DOPPIO ESAGONO - DADO TIEFFE</p>	147	HX-FIP90C	 <p>JIC FEMALE 37° CONE SEAT 90° ELBOW - SHORT DROP CRIMPED-BACK NUT FEMMINA JIC SVASATA 37° CURVA A 90° - CORTA DADO PRESSATO</p>	150
HX-FIP45	 <p>JIC FEMALE 37° CONE SEAT 45° ELBOW - CRIMPED-BACK NUT FEMMINA JIC SVASATA 37° CURVA A 45° - DADO PRESSATO</p>	148	HX-FIP90L	 <p>JIC FEMALE 37° CONE SEAT 90° ELBOW - LONG DROP CRIMPED-BACK NUT FEMMINA JIC SVASATA 37° CURVA A 90° - LUNGA DADO PRESSATO</p>	150

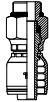

AMERICAN STANDARD CONNECTIONS - ORFS (SAE J516 / ISO 12151-1)

REFERENCE	DESCRIPTION	PAGE	REFERENCE	DESCRIPTION	PAGE
HX-MRS	 <p>ORFS MALE MASCHIO ORFS</p>	151	HX-FRS45	 <p>ORFS FEMALE 45° ELBOW - SLIP-ON NUT FEMMINA ORFS CURVA A 45° - DADO LIBERO</p>	153
HX-FRS	 <p>ORFS FEMALE SLIP-ON NUT FEMMINA ORFS DADO LIBERO</p>	152	HX-FRS90C	 <p>ORFS FEMALE 90° ELBOW - SHORT DROP SLIP-ON NUT FEMMINA ORFS CURVA A 90° - CORTA DADO LIBERO</p>	154
HX-FRC	 <p>ORFS FEMALE DOUBLE EXAGON - CRIMPED-BACK NUT FEMMINA ORFS DOPPIO ESAGONO - DADO PRESSATO</p>	152	HX-FRS90L	 <p>ORFS FEMALE 90° ELBOW - LONG DROP SLIP-ON NUT FEMMINA ORFS CURVA A 90° - LUNGA DADO LIBERO</p>	154

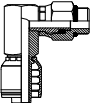
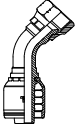
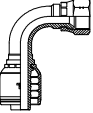

AMERICAN STANDARD CONNECTIONS - SAE

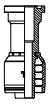
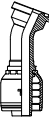
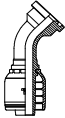
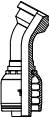
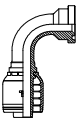
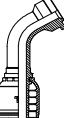
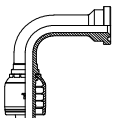
REFERENCE	DESCRIPTION	PAGE	REFERENCE	DESCRIPTION	PAGE
HX-MS	 <p>SAE O-RING BOSS MALE SAE J516 MASCHIO SAE O-RING SAE J516</p>	155	HX-MJ	 <p>SAE MALE 45° CONE SAE J513 MASCHIO SAE CONO 45° SAE J513</p>	156
HX-SMS	 <p>SAE O-RING BOSS SWIVEL MALE MASCHIO GIREVOLE SAE O-RING</p>	155	HX-FJCP	 <p>SAE FEMALE 45° CONE SEAT DOUBLE EXAGON - CRIMPED BACK NUT SAE J513 FEMMINA SAE SVASATA 45° DOPPIO ESAGONO - DADO PRESSATO SAE J513</p>	156
HX-SMS90	 <p>SAE O-RING BOSS SWIVEL MALE 90° COMPACT ELBOW MASCHIO GIREVOLE SAE O-RING CURVA A 90° COMPATTA</p>	155	HX-FJP45	 <p>SAE FEMALE 45° CONE SEAT 45° ELBOW - CRIMPED BACK NUT SAE J513 FEMMINA SAE SVASATA 45° CURVA A 45° - DADO PRESSATO SAE J513</p>	156
			HX-FJP90	 <p>SAE FEMALE 45° CONE SEAT 90° ELBOW - CRIMPED BACK NUT SAE J513 FEMMINA SAE SVASATA 45° CURVA A 90° - DADO PRESSATO SAE J513</p>	156

AMERICAN STANDARD CONNECTIONS - FLANGE CODE 61 (SAE J516 / ISO 12151-3)

REFERENCE	DESCRIPTION	PAGE	REFERENCE	DESCRIPTION	PAGE
HX-FL	 SAE CODE 61 FLANGE FLANGIA SAE CODE 61	157	HX-FL22	 SAE CODE 61 FLANGE 22,5° ELBOW FLANGIA SAE CODE 61 CURVA A 22,5°	159
HX-FL45	 SAE CODE 61 FLANGE 45° ELBOW FLANGIA SAE CODE 61 CURVA A 45°	157	HX-FL30	 SAE CODE 61 FLANGE 30° ELBOW FLANGIA SAE CODE 61 CURVA A 30°	159
HX-FL90	 SAE CODE 61 FLANGE 90° ELBOW FLANGIA SAE CODE 61 CURVA A 90°	158	HX-FL60	 SAE CODE 61 FLANGE 60° ELBOW FLANGIA SAE CODE 61 CURVA A 60°	160
HX-FL90-K-	 SAE CODE 61 FLANGE 90° ELBOW - LONG DROP FLANGIA SAE CODE 61 CURVA A 90° - LUNGA	158	HX-FL67	 SAE CODE 61 FLANGE 67,5° ELBOW FLANGIA SAE CODE 61 CURVA A 67,5°	160

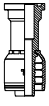
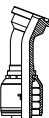
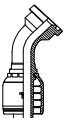
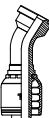
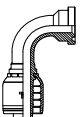
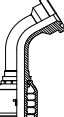
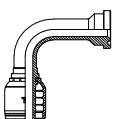

AMERICAN STANDARD CONNECTIONS - FLANGE CODE 62 (SAE J516 / ISO 12151-3)

REFERENCE	DESCRIPTION	PAGE	REFERENCE	DESCRIPTION	PAGE
HX-FP	 SAE CODE 62 FLANGE FLANGIA SAE CODE 62	161	HX-FP22	 SAE CODE 62 FLANGE 22,5° ELBOW FLANGIA SAE CODE 62 CURVA A 22,5°	163
HX-FP45	 SAE CODE 62 FLANGE 45° ELBOW FLANGIA SAE CODE 62 CURVA A 45°	161	HX-FP30	 SAE CODE 62 FLANGE 30° ELBOW FLANGIA SAE CODE 62 CURVA A 30°	163
HX-FL90	 SAE CODE 62 FLANGE 90° ELBOW FLANGIA SAE CODE 62 CURVA A 90°	162	HX-FP60	 SAE CODE 62 FLANGE 60° ELBOW FLANGIA SAE CODE 62 CURVA A 60°	164
HX-FP90-K-	 SAE CODE 62 FLANGE 90° ELBOW - LONG DROP FLANGIA SAE CODE 62 CURVA A 90° - LUNGA	162	HX-FP67	 SAE CODE 62 FLANGE 67,5° ELBOW FLANGIA SAE CODE 62 CURVA A 67,5°	164

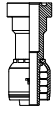
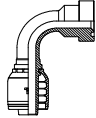
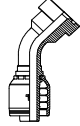







OEM CONNECTIONS - "SUPERCAT" FLANGE

REFERENCE	DESCRIPTION	PAGE	REFERENCE	DESCRIPTION	PAGE
HX-YP	 "SUPERCAT" FLANGE FLANGIA "SUPERCAT"	165	HX-YP90	 "SUPERCAT" FLANGE 90° ELBOW FLANGIA "SUPERCAT" CURVA A 90°	165
HX-YP45	 "SUPERCAT" FLANGE 45° ELBOW FLANGIA "SUPERCAT" CURVA A 45°	165			



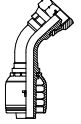

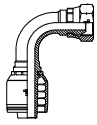
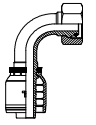
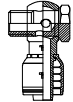
JAPANESE STANDARD CONNECTIONS (JIS B8363)

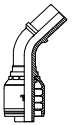
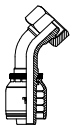
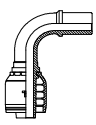
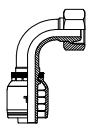
REFERENCE	DESCRIPTION	PAGE	REFERENCE	DESCRIPTION	PAGE
HX-FGCP	 "NISSAN" BSP FEMALE 60° CONE - DOUBLE EXAGON CRIMPED BACK NUT FEMMINA GAS "NISSAN" OGIVA 60° - DOPPIO ESAGONO DADO PRESSATO	166	HX-FMG	 "KOMATSU" METRIC FEMALE 60° CONE SEAT - DOUBLE EXAGON CRIMPED BACK NUT FEMMINA METRICA "KOMATSU" SVASATA 60° - DOPPIO ESAGONO DADO PRESSATO	166
HX-FTC	 "TOYOTA" BSP FEMALE 60° CONE SEAT - DOUBLE EXAGON CRIMPED BACK NUT FEMMINA GAS "TOYOTA" SVASATA 60° - DOPPIO ESAGONO DADO PRESSATO	166			

DIN STANDARD CONNECTIONS

REFERENCE	DESCRIPTION	PAGE	REFERENCE	DESCRIPTION	PAGE
HX-MW	 <p>METRIC MALE 60° CONE SEAT DIN 3863 MASCHIO METRICO SVASATO 60° DIN 3863</p>	167	HX-MM	 <p>METRIC MALE 24° CONE SEAT DIN 20066 - ISO 12151-2 MASCHIO METRICO SVASATO 24° DIN 20066 - ISO 12151-2</p>	173
HX-FW	 <p>METRIC FEMALE 60° CONE CRIMPED-BACK NUT DIN 3863 / 20078 FEMMINA METRICA OGIVA 60° DADO PRESSATO DIN 3863 / 20078</p>	168	HX-FOS	 <p>METRIC FEMALE 24° O'RING CONE SLIP-ON NUT DIN 20066 - ISO 12151-2 FEMMINA METRICA OGIVA 24° O'RING DADO LIBERO DIN 20066 - ISO 12151-2</p>	174
HX-FW45	 <p>METRIC FEMALE 60° CONE 45° ELBOW - CRIMPED BACK NUT DIN 3863 / 20078 FEMMINA METRICA OGIVA 60° CURVA A 45° - DADO PRESSATO DIN 3863 / 20078</p>	169	HX-FOS45	 <p>METRIC FEMALE 24° O'RING CONE 45° ELBOW - SLIP-ON NUT DIN 20066 - ISO 12151-2 FEMM. METR. OGIVA 24° O'RING CURVA A 45° - DADO LIBERO DIN 20066 - ISO 12151-2</p>	175
HX-FW90	 <p>METRIC FEMALE 60° CONE 90° ELBOW - CRIMPED BACK NUT DIN 3863 / 20078 FEMMINA METRICA OGIVA 60° CURVA A 90° - DADO PRESSATO DIN 3863 / 20078</p>	170	HX-FOS90	 <p>METRIC FEMALE 24° O'RING CONE 90° ELBOW - SLIP-ON NUT DIN 20066 - ISO 12151-2 FEMM. METR. OGIVA 24° O'RING CURVA A 90° - DADO LIBERO DIN 20066 - ISO 12151-2</p>	176
CP-OM	 <p>METRIC BANJO OCCHIO METRICO</p>	171	HX-ET	 <p>METRIC STANDPIPE DIN 2353 - ISO 8434-1 ESTREMITA' TUBOLARE METRICA DIN 2353 - ISO 8434-1</p>	177
HX-FM	 <p>METRIC FEMALE MULTISEAL SLIP-ON NUT DIN 3868 / 20078 FEMMINA METRICA MULTISEAL DADO LIBERO DIN 3868 / 20078</p>	172	HX-ET45	 <p>METRIC STANDPIPE 45° ELBOW DIN 2353 - ISO 8434-1 ESTREMITA' TUBOLARE METRICA CURVA A45° DIN 2353 - ISO 8434-1</p>	178
HX-FM45	 <p>METRIC FEMALE MULTISEAL 45° ELBOW - SLIP-ON NUT DIN 3868 / 20078 FEMM. METRICA MULTISEAL CURVA A 45° - DADO LIBERO DIN 3868 / 20078</p>	172	HX-ET90	 <p>METRIC STANDPIPE 90° ELBOW DIN 2353 - ISO 8434-1 ESTREMITA' TUBOLARE METRICA CURVA A90° DIN 2353 - ISO 8434-1</p>	179
HX-FM90	 <p>METRIC FEMALE MULTISEAL 90° ELBOW - SLIP-ON NUT DIN 3868 / 20078 FEMM. METRICA MULTISEAL CURVA A 90° - DADO LIBERO DIN 3868 / 20078</p>	172			

FRENCH STANDARD CONNECTIONS (NF)

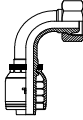
REFERENCE	DESCRIPTION	PAGE	REFERENCE	DESCRIPTION	PAGE
HX-MF	 <p>METRIC MALE 24° CONE SEAT FRENCH GAZ TYPE MASCHIO METRICO SVASATO 24° TIPO GAZ FRANCESE</p>	180	HX-FF	 <p>METRIC FEMALE 24° CONE SLIP-ON NUT - FRENCH GAZ TYPE FEMMINA METRICA CONO 24° DADO LIBERO - TIPO GAZ FRANCESE</p>	180
HX-ETF	 <p>STRAIGHT STANDPIPE FRENCH GAZ TYPE ESTREMITA' TUBOLARE DIRITTA TIPO GAZ FRANCESE</p>	180	HX-FF45	 <p>METRIC FEMALE 24° CONE 45° ELBOW - SLIP-ON NUT FRENCH GAZ TYPE FEMMINA METRICA CONO 24° CURVA A 45° - DADO LIBERO TIPO GAZ FRANCESE</p>	181
			HX-FF90	 <p>METRIC FEMALE 24° CONE 90° ELBOW - SLIP-ON NUT FRENCH GAZ TYPE FEMMINA METRICA CONO 24° CURVA A 90° - DADO LIBERO TIPO GAZ FRANCESE</p>	181

ACCESSORIES

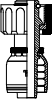
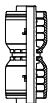
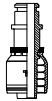
REFERENCE	DESCRIPTION	PAGE	REFERENCE	DESCRIPTION	PAGE
HX-FK	 <p>WASHCLEANER METRIC FEMALE "FK" TYPE FEMMINA METRICA PER IDROPULITRICI TIPO "FK"</p>	182	HX-HX	 <p>DOUBLE STEM DOPPIO CODOLO</p>	182
HX-IR	 <p>PISTOL WASHCLEANER JUNCTION ATTACCO PER PISTOLE IDROPULITRICI</p>	182			

MGC
BSP TAPERED MALE 60° CONE SEAT
 MASCHIO GAS CONICO SVASATO 60°

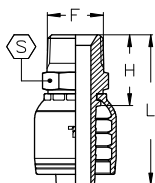
AGR-K

TIEFFE Part.N.	Hose Size			BSP Connection Size		Dimensions (mm)						Maximum W.P.	
	DN	Inch	Dash	F	Dash	H	L	S				bar	PSI
HX0302MGC	5	3/16"	-03	1/8"-28	-02	20	45	12				350	5000
HX0304MGC	5	3/16"	-03	1/4"-19	-04	25	50	15				350	5000
HX0402MGC	6,3	1/4"	-04	1/8"-28	-02	21	49	12				350	5000
HX0404MGC	6,3	1/4"	-04	1/4"-19	-04	25	53	15				350	5000
HX0406MGC	6,3	1/4"	-04	3/8"-19	-06	26	54	19				280	4000
HX0504MGC	8	5/16"	-05	1/4"-19	-04	25	53	15				280	4000
HX0506MGC	8	5/16"	-05	3/8"-19	-06	26	54	19				280	4000
HX0604MGC	10	3/8"	-06	1/4"-19	-04	26	56	15				280	4000
HX0606MGC	10	3/8"	-06	3/8"-19	-06	27	57	19				280	4000
HX0608MGC	10	3/8"	-06	1/2"-14	-08	32	63	22				280	4000
HX0806MGC	12,5	1/2"	-08	3/8"-19	-06	28	64	19				280	4000
HX0808MGC	12,5	1/2"	-08	1/2"-14	-08	33	66	22				280	4000
HX1008MGC	16	5/8"	-10	1/2"-14	-08	33	69	22				280	4000
HX1012MGC	16	5/8"	-10	3/4"-14	-12	35	71	27				280	4000
HX1212MGC	19	3/4"	-12	3/4"-14	-12	36	77	27				280	4000
HX1216MGC	19	3/4"	-12	1"-11	-16	41	82	36				280	4000
HX1616MGC	25	1"	-16	1"-11	-16	43	94	36				210	3000
HX1620MGC	25	1"	-16	1 1/4"-11	-20	47	98	46				210	3000
HX2020MGC	31,5	1 1/4"	-20	1 1/4"-11	-20	48	106	46				125	1800
HX2424MGC	38	1 1/2"	-24	1 1/2"-11	-24	49	114	50				90	1300
HX3232MGC	51	2"	-32	2"-11	-32	57	127	65				80	1160

MG
BSP PARALLEL MALE 60° CONE SEAT
 MASCHIO GAS CILINDRICO SVASATO 60°

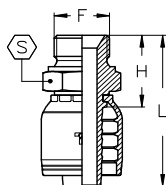
AGR

TIEFFE Part.N.	Hose Size			BSP Connection Size		Dimensions (mm)						Maximum W.P.	
	DN	Inch	Dash	F	Dash	H	L	S				bar	PSI
HX0302MG	5	3/16"	-03	1/8"-28	-02	20	45	14				415	6000
HX0304MG	5	3/16"	-03	1/4"-19	-04	24	49	19				415	6000
HX0402MG	6,3	1/4"	-04	1/8"-28	-02	20	48	14				400	5800
HX0404MG	6,3	1/4"	-04	1/4"-19	-04	25	53	19				400	5800
HX0406MG	6,3	1/4"	-04	3/8"-19	-06	27	55	22				400	5800
HX0408MG	6,3	1/4"	-04	1/2"-14	-08	32	60	27				400	5800
HX0504MG	8	5/16"	-05	1/4"-19	-04	25	53	19				350	5000
HX0506MG	8	5/16"	-05	3/8"-19	-06	27	55	22				350	5000
HX0508MG	8	5/16"	-05	1/2"-14	-08	32	60	27				350	5000
HX0604MG	10	3/8"	-06	1/4"-19	-04	25	55	19				330	4800
HX0606MG	10	3/8"	-06	3/8"-19	-06	27	58	22				330	4800
HX0608MG	10	3/8"	-06	1/2"-14	-08	32	62	27				330	4800
HX0806MG	12,5	1/2"	-08	3/8"-19	-06	28	61	22				280	4000
HX0808MG	12,5	1/2"	-08	1/2"-14	-08	33	66	27				280	4000
HX0810MG	12,5	1/2"	-08	5/8"-14	-10	35	68	30				280	4000
HX0812MG	12,5	1/2"	-08	3/4"-14	-12	36	69	32				280	4000
HX1008MG	16	5/8"	-10	1/2"-14	-08	33	69	27				280	4000
HX1010MG	16	5/8"	-10	5/8"-14	-10	35	71	30				280	4000
HX1012MG	16	5/8"	-10	3/4"-14	-12	36	72	32				280	4000
HX1208MG	19	3/4"	-12	1/2"-14	-08	34	74	27				280	4000
HX1210MG	19	3/4"	-12	5/8"-14	-10	36	76	30				280	4000
HX1212MG	19	3/4"	-12	3/4"-14	-12	37	77	32				280	4000
HX1216MG	19	3/4"	-12	1"-11	-16	42	82	41				280	4000
HX1612MG	25	1"	-16	3/4"-14	-12	38	89	32				210	3000
HX1616MG	25	1"	-16	1"-11	-16	43	94	41				210	3000
HX1620MG	25	1"	-16	1 1/4"-11	-20	46	97	50				210	3000
HX2020MG	31,5	1 1/4"	-20	1 1/4"-11	-20	47	105	50				125	1800
HX2024MG	31,5	1 1/4"	-20	1 1/2"-11	-24	50	108	55				125	1800
HX2424MG	38	1 1/2"	-24	1 1/2"-11	-24	50	115	55				90	1300
HX2432MG	38	1 1/2"	-24	2"-11	-32	55	119	70				90	1300
HX3232MG	51	2"	-32	2"-11	-32	56	126	70				80	1160

FGP
BSP FEMALE 60° CONE - CRIMPED-BACK NUT
 FEMMINA GAS OGIVA 60° - DADO PRESSATO

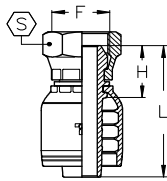
DKR

TIEFFE Part.N.	Hose Size			BSP Connection Size		Dimensions (mm)					Maximum W.P.	
	DN	Inch	Dash	F	Dash	H	L	S			bar	PSI
HX0302FGP	5	3/16"	-03	1/8"-28	-02	16	41	14			415	6000
HX0304FGP	5	3/16"	-03	1/4"-19	-04	19	44	19			415	6000
HX0402FGP	6,3	1/4"	-04	1/8"-28	-02	17	45	14			400	5800
HX0404FGP	6,3	1/4"	-04	1/4"-19	-04	19	47	19			400	5800
HX0406FGP	6,3	1/4"	-04	3/8"-19	-06	22	50	22			400	5800
HX0408FGP	6,3	1/4"	-04	1/2"-14	-08	23	51	27			400	5800
HX0504FGP	8	5/16"	-05	1/4"-19	-04	19	47	19			350	5000
HX0506FGP	8	5/16"	-05	3/8"-19	-06	22	50	22			350	5000
HX0508FGP	8	5/16"	-05	1/2"-14	-08	23	51	27			350	5000
HX0604FGP	10	3/8"	-06	1/4"-19	-04	19	49	19			330	4800
HX0606FGP	10	3/8"	-06	3/8"-19	-06	21	51	22			330	4800
HX0608FGP	10	3/8"	-06	1/2"-14	-08	23	54	27			330	4800
HX0806FGP	12,5	1/2"	-08	3/8"-19	-06	22	56	22			280	4000
HX0808FGP	12,5	1/2"	-08	1/2"-14	-08	23	56	27			280	4000
HX0810FGP	12,5	1/2"	-08	5/8"-14	-10	24	57	30			280	4000
HX0812FGP	12,5	1/2"	-08	3/4"-14	-12	27	60	32			280	4000
HX1008FGP	16	5/8"	-10	1/2"-14	-08	23	59	27			280	4000
HX1010FGP	16	5/8"	-10	5/8"-14	-10	23	59	30			280	4000
HX1012FGP	16	5/8"	-10	3/4"-14	-12	27	63	32			280	4000
HX1208FGP	19	3/4"	-12	1/2"-14	-08	24	65	27			280	4000
HX1210FGP	19	3/4"	-12	5/8"-14	-10	24	64	30			280	4000
HX1212FGP	19	3/4"	-12	3/4"-14	-12	27	67	32			280	4000
HX1216FGP	19	3/4"	-12	1"-11	-16	30	70	41			280	4000
HX1612FGP	25	1"	-16	3/4"-14	-12	28	79	32			210	3000
HX1616FGP	25	1"	-16	1"-11	-16	30	81	41			210	3000
HX1620FGP	25	1"	-16	1 1/4"-11	-20	35	86	50			210	3000
HX2020FGP	31,5	1 1/4"	-20	1 1/4"-11	-20	34	92	50			125	1800
HX2024FGP	31,5	1 1/4"	-20	1 1/2"-11	-24	36	93	55			125	1800
HX2424FGP	38	1 1/2"	-24	1 1/2"-11	-24	34	99	55			90	1300
HX2432FGP	38	1 1/2"	-24	2"-11	-32	39	103	70			90	1300
HX3232FGP	51	2"	-32	2"-11	-32	37	107	70			80	1160

**FGL
FGS**
BSP FEMALE 60° CONE - FULL EXAGON NUT
 FEMMINA GAS OGIVA 60° - DADO TUTTO ESAGONO

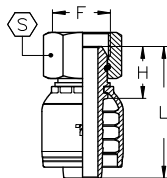
DKR

TIEFFE Part.N.	Hose Size			BSP Connection Size		Dimensions (mm)					Maximum W.P.	
	DN	Inch	Dash	F	Dash	H	L	S			bar	PSI
HX0404FGL	6,3	1/4"	-04	1/4"-19	-04	19	47	19			400	5800
HX0406FGL	6,3	1/4"	-04	3/8"-19	-06	19	47	22			400	5800
HX0506FGL	8	5/16"	-05	3/8"-19	-06	19	47	22			350	5000
HX0606FGL	10	3/8"	-06	3/8"-19	-06	19	50	22			330	4800
HX0608FGL	10	3/8"	-06	1/2"-14	-08	21	52	27			330	4800
HX0808FGL	12,5	1/2"	-08	1/2"-14	-08	22	55	27			280	4000
HX0810FGS	12,5	1/2"	-08	5/8"-14	-10	24	57	30			280	4000
HX1010FGS	16	5/8"	-10	5/8"-14	-10	23	59	30			280	4000
HX1012FGS	16	5/8"	-10	3/4"-14	-12	27	63	32			280	4000
HX1212FGS	20	3/4"	-12	3/4"-14	-12	27	67	32			280	4000
HX1216FGS	20	3/4"	-12	1"-11	-16	31	72	41			280	4000
HX1616FGS	25	1"	-16	1"-11	-16	31	82	41			210	3000

FGL - Slip-on nut (Dado libero)

FGS - Tieffe nut (Dado TIEFFE)

FGP45
BSP FEMALE 60° CONE - 45° ELBOW - CRIMPED-BACK NUT
 FEMMINA GAS OGIVA 60° - CURVA A 45° - DADO PRESSATO

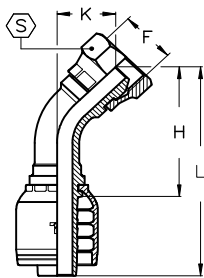
DKR45

TIEFFE Part.N.	Hose Size			BSP Connection Size		Dimensions (mm)					Maximum W.P.		
	DN	Inch	Dash	F	Dash	H	L	K	S		bar	PSI	
HX0302FGP45	5	3/16"	-03	1/8"-28	-02	33	58	14	14			415	6000
HX0304FGP45	5	3/16"	-03	1/4"-19	-04	35	60	16	19			415	6000
HX0402FGP45	6,3	1/4"	-04	1/8"-28	-02	36	64	16	14			400	5800
HX0404FGP45	6,3	1/4"	-04	1/4"-19	-04	37	65	16	19			400	5800
HX0406FGP45	6,3	1/4"	-04	3/8"-19	-06	40	68	19	22			400	5800
HX0408FGP45	6,3	1/4"	-04	1/2"-14	-08	42	70	21	27			400	5800
HX0504FGP45	8	5/16"	-05	1/4"-19	-04	39	67	18	19			350	5000
HX0506FGP45	8	5/16"	-05	3/8"-19	-06	41	69	19	22			350	5000
HX0508FGP45	8	5/16"	-05	1/2"-14	-08	43	71	21	27			350	5000
HX0604FGP45	10	3/8"	-06	1/4"-19	-04	41	72	18	19			330	4800
HX0606FGP45	10	3/8"	-06	3/8"-19	-06	42	73	19	22			330	4800
HX0608FGP45	10	3/8"	-06	1/2"-14	-08	44	75	21	27			330	4800
HX0806FGP45	12,5	1/2"	-08	3/8"-19	-06	49	82	22	22			280	4000
HX0808FGP45	12,5	1/2"	-08	1/2"-14	-08	49	82	22	27			280	4000
HX0810FGP45	12,5	1/2"	-08	5/8"-14	-10	49	82	22	30			280	4000
HX0812FGP45	12,5	1/2"	-08	3/4"-14	-12	53	86	26	32			280	4000
HX1008FGP45	16	5/8"	-10	1/2"-14	-08	57	93	26	27			280	4000
HX1010FGP45	16	5/8"	-10	5/8"-14	-10	54	90	24	30			280	4000
HX1012FGP45	16	5/8"	-10	3/4"-14	-12	57	93	26	32			280	4000
HX1208FGP45	19	3/4"	-12	1/2"-14	-08	68	108	30	27			280	4000
HX1210FGP45	19	3/4"	-12	5/8"-14	-10	66	106	28	30			280	4000
HX1212FGP45	19	3/4"	-12	3/4"-14	-12	66	106	28	32			280	4000
HX1216FGP45	19	3/4"	-12	1"-11	-16	68	108	30	41			280	4000
HX1612FGP45	25	1"	-16	3/4"-14	-12	87	138	38	32			210	3000
HX1616FGP45	25	1"	-16	1"-11	-16	84	135	36	41			210	3000
HX1620FGP45	25	1"	-16	1 1/4"-11	-20	85	136	37	50			210	3000
HX2020FGP45	31,5	1 1/4"	-20	1 1/4"-11	-20	100	157	43	50			125	1800
HX2024FGP45	31,5	1 1/4"	-20	1 1/2"-11	-24	100	157	43	55			125	1800
HX2424FGP45	38	1 1/2"	-24	1 1/2"-11	-24	116	180	49	55			90	1300
HX2432FGP45	38	1 1/2"	-24	2"-11	-32	116	180	49	70			90	1300
HX3232FGP45	51	2"	-32	2"-11	-32	157	227	69	70			80	1160

**FGL45
FGS45**
BSP FEMALE 60° CONE - 45° ELBOW - FULL EXAGON NUT
 FEMMINA GAS OGIVA 60° - CURVA A 45° - DADO TUTTO ESAGONO

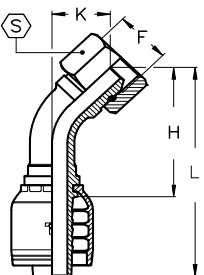
DKR45

TIEFFE Part.N.	Hose Size			BSP Connection Size		Dimensions (mm)					Maximum W.P.		
	DN	Inch	Dash	F	Dash	H	L	K	S		bar	PSI	
HX0404FGL45	6,3	1/4"	-04	1/4"-19	-04	35	63	13	19			400	5800
HX0406FGL45	6,3	1/4"	-04	3/8"-19	-06	36	64	14	22			400	5800
HX0506FGL45	8	5/16"	-05	3/8"-19	-06	37	65	14	22			350	5000
HX0606FGL45	10	3/8"	-06	3/8"-19	-06	38	68	14	22			330	4800
HX0608FGL45	10	3/8"	-06	1/2"-14	-08	41	71	17	27			330	4800
HX0808FGL45	12,5	1/2"	-08	1/2"-14	-08	44	77	18	27			280	4000
HX0810FGS45	12,5	1/2"	-08	5/8"-14	-10	49	82	23	30			280	4000
HX1010FGS45	16	5/8"	-10	5/8"-14	-10	54	90	23	30			280	4000
HX1012FGS45	16	5/8"	-10	3/4"-14	-12	57	93	26	32			280	4000
HX1212FGS45	19	3/4"	-12	3/4"-14	-12	66	106	29	32			280	4000
HX1216FGS45	19	3/4"	-12	1"-11	-16	68	109	31	41			280	4000
HX1616FGS45	25	1"	-16	1"-11	-16	84	135	36	41			210	3000

FGL - Slip-on nut (Dado libero)

FGS - Tieffe nut (Dado TIEFFE)

FGP90
BSP FEMALE 60° CONE - 90° ELBOW - CRIMPED-BACK NUT
 FEMMINA GAS OGIVA 60° - CURVA A 90° - DADO PRESSATO

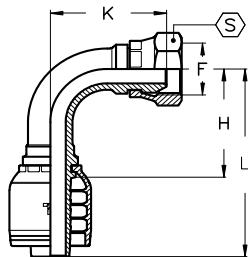
DKR90

TIEFFE Part.N.	Hose Size			BSP Connection Size		Dimensions (mm)					Maximum W.P.		
	DN	Inch	Dash	F	Dash	H	L	K	S		bar	PSI	
HX0302FGP90	5	3/16"	-03	1/8"-28	-02	21	46	23	14			415	6000
HX0304FGP90	5	3/16"	-03	1/4"-19	-04	21	46	26	19			415	6000
HX0402FGP90	6,3	1/4"	-04	1/8"-28	-02	26	54	28	14			400	5800
HX0404FGP90	6,3	1/4"	-04	1/4"-19	-04	26	54	28	19			400	5800
HX0406FGP90	6,3	1/4"	-04	3/8"-19	-06	26	54	32	22			400	5800
HX0408FGP90	6,3	1/4"	-04	1/2"-14	-08	26	54	36	27			400	5800
HX0504FGP90	8	5/16"	-05	1/4"-19	-04	28	56	31	19			350	5000
HX0506FGP90	8	5/16"	-05	3/8"-19	-06	28	56	34	22			350	5000
HX0508FGP90	8	5/16"	-05	1/2"-14	-08	28	56	37	27			350	5000
HX0604FGP90	10	3/8"	-06	1/4"-19	-04	31	61	34	19			330	4800
HX0606FGP90	10	3/8"	-06	3/8"-19	-06	31	61	35	22			330	4800
HX0608FGP90	10	3/8"	-06	1/2"-14	-08	31	61	38	27			330	4800
HX0806FGP90	12,5	1/2"	-08	3/8"-19	-06	37	70	42	22			280	4000
HX0808FGP90	12,5	1/2"	-08	1/2"-14	-08	37	70	42	27			280	4000
HX0810FGP90	12,5	1/2"	-08	5/8"-14	-10	37	70	43	30			280	4000
HX0812FGP90	12,5	1/2"	-08	3/4"-14	-12	37	70	48	32			280	4000
HX1008FGP90	16	5/8"	-10	1/2"-14	-08	45	80	50	27			280	4000
HX1010FGP90	16	5/8"	-10	5/8"-14	-10	45	80	46	30			280	4000
HX1012FGP90	16	5/8"	-10	3/4"-14	-12	45	80	50	32			280	4000
HX1208FGP90	19	3/4"	-12	1/2"-14	-08	54	95	59	27			280	4000
HX1210FGP90	19	3/4"	-12	5/8"-14	-10	54	95	56	30			280	4000
HX1212FGP90	19	3/4"	-12	3/4"-14	-12	54	95	56	32			280	4000
HX1216FGP90	19	3/4"	-12	1"-11	-16	54	95	59	41			280	4000
HX1612FGP90	25	1"	-16	3/4"-14	-12	70	121	75	32			210	3000
HX1616FGP90	25	1"	-16	1"-11	-16	70	121	72	41			210	3000
HX1620FGP90	25	1"	-16	1 1/4"-11	-20	70	121	73	50			210	3000
HX2020FGP90	31,5	1 1/4"	-20	1 1/4"-11	-20	84	142	87	50			125	1800
HX2024FGP90	31,5	1 1/4"	-20	1 1/2"-11	-24	84	142	87	55			125	1800
HX2424FGP90	38	1 1/2"	-24	1 1/2"-11	-24	100	165	100	55			90	1300
HX2432FGP90	38	1 1/2"	-24	2"-11	-32	100	165	100	70			90	1300
HX3232FGP90	51	2"	-32	2"-11	-32	134	204	141	70			80	1160

**FGL90
FGS90**
BSP FEMALE 60° CONE - 90° ELBOW - FULL EXAGON NUT
 FEMMINA GAS OGIVA 60° - CURVA A 90° - DADO TUTTO ESAGONO

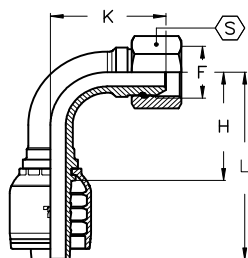
DKR90

TIEFFE Part.N.	Hose Size			BSP Connection Size		Dimensions (mm)					Maximum W.P.		
	DN	Inch	Dash	F	Dash	H	L	K	S		bar	PSI	
HX0404FGL90	6,3	1/4"	-04	1/4"-19	-04	29	57	26	19			400	5800
HX0406FGL90	6,3	1/4"	-04	3/8"-19	-06	29	57	28	22			400	5800
HX0506FGL90	8	5/16"	-05	3/8"-19	-06	29	57	28	22			350	5000
HX0606FGL90	10	3/8"	-06	3/8"-19	-06	30	61	29	22			330	4800
HX0608FGL90	10	3/8"	-06	1/2"-14	-08	30	61	32	27			330	4800
HX0808FGL90	12,5	1/2"	-08	1/2"-14	-08	37	70	35	27			280	4000
HX0810FGS90	12,5	1/2"	-08	5/8"-14	-10	37	70	43	30			280	4000
HX1010FGS90	16	5/8"	-10	5/8"-14	-10	44	80	46	30			280	4000
HX1012FGS90	16	5/8"	-10	3/4"-14	-12	44	80	50	32			280	4000
HX1212FGS90	19	3/4"	-12	3/4"-14	-12	54	94	56	32			280	4000
HX1216FGS90	19	3/4"	-12	1"-11	-16	54	94	60	41			280	4000
HX1616FGS90	25	1"	-16	1"-11	-16	70	121	72	41			210	3000

FGL - Slip-on nut (Dado libero)

FGS - Tieffe nut (Dado TIEFFE)

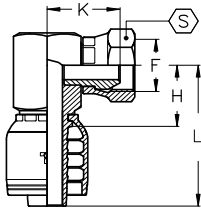
FGP90K
BSP FEMALE 60° CONE - 90° COMPACT ELBOW - CRIMPED-BACK NUT
FEMMINA GAS OGIVA 60° - CURVA COMPATTA 90° - DADO PRESSATO
DKR90
COMPACT

TIEFFE Part.N.	Hose Size			BSP Connection Size		Dimensions (mm)					Maximum W.P.	
	DN	Inch	Dash	F	Dash	H	L	K	S		bar	PSI
HX0404FGP90K	6,3	1/4"	-04	1/4"-19	-04	18	46	23	19		400	5800
HX0406FGP90K	6,3	1/4"	-04	3/8"-19	-06	21	49	26	22		400	5800
HX0506FGP90K	8	5/16"	-05	3/8"-19	-06	21	49	26	22		350	5000
HX0606FGP90K	10	3/8"	-06	3/8"-19	-06	21	52	26	22		330	4800
HX0608FGP90K	10	3/8"	-06	1/2"-14	-08	24	54	28	27		330	4800
HX0808FGP90K	12,5	1/2"	-08	1/2"-14	-08	24	57	28	27		280	4000
HX1212FGP90K	19	3/4"	-12	3/4"-14	-12	31	72	35	32		280	4000
HX1616FGP90K	25	1"	-16	1"-11	-16	38	89	41	41		210	3000

**FGOL
FGOS**
BSP FEMALE 60° O'RING CONE - FULL EXAGON NUT
 FEMMINA GAS OGIVA 60° O'RING - DADO TUTTO ESAGONO

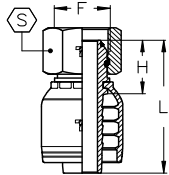
DKOR

TIEFFE Part.N.	Hose Size			BSP Connection Size		Dimensions (mm)					Maximum W.P.	
	DN	Inch	Dash	F	Dash	H	L	S	O-RING	bar	PSI	
HX0404FGOL	6,3	1/4"	-04	1/4"-19	-04	22	50	19	6,5x1	400	5800	
HX0406FGOL	6,3	1/4"	-04	3/8"-19	-06	24	52	22	8,5x1,5	400	5800	
HX0506FGOL	8	5/16"	-05	3/8"-19	-06	24	52	22	8,5x1,5	350	5000	
HX0606FGOL	10	3/8"	-06	3/8"-19	-06	24	54	22	8,5x1,5	330	4800	
HX0608FGOL	10	3/8"	-06	1/2"-14	-08	26	56	27	11,5x1,5	330	4800	
HX0808FGOL	12,5	1/2"	-08	1/2"-14	-08	26	59	27	11,5x1,5	280	4000	
HX0810FGOS	12,5	1/2"	-08	5/8"-14	-10	26	59	30	13x1,5	280	4000	
HX1010FGOS	16	5/8"	-10	5/8"-14	-10	25	61	30	13x1,5	280	4000	
HX1012FGOS	16	5/8"	-10	3/4"-14	-12	28	64	32	17x1,5	280	4000	
HX1212FGOS	19	3/4"	-12	3/4"-14	-12	28	68	32	17x1,5	280	4000	
HX1216FGOS	19	3/4"	-12	1"-11	-16	32	73	41	22x1,5	280	4000	
HX1616FGOS	25	1"	-16	1"-11	-16	32	83	41	22x1,5	210	3000	
HX1620FGOS	25	1"	-16	1 1/4"-11	-20	37	88	50	28,3x1,78	210	3000	
HX2020FGOS	31,5	1 1/4"	-20	1 1/4"-11	-20	36	94	50	28,3x1,78	125	1800	
HX2024FGOS	31,5	1 1/4"	-20	1 1/2"-11	-24	39	97	55	33,05x1,78	125	1800	
HX2424FGOS	38	1 1/2"	-24	1 1/2"-11	-24	38	102	55	33,05x1,78	90	1300	
HX2432FGOS	38	1 1/2"	-24	2"-11	-32	41	105	70	44,17x1,78	90	1300	
HX3232FGOS	51	2"	-32	2"-11	-32	40	110	70	44,17x1,78	80	1160	

FGOL - Slip-on nut (Dado libero)

FGOS - Tiefte nut (Dado TIEFFE)

**FGOL45
FGOS45**
BSP FEMALE 60° O-RING CONE - 45° ELBOW - FULL EXAGON NUT
 FEMMINA GAS OGIVA 60° O-RING - CURVA A 45° - DADO TUTTO ESAGONO

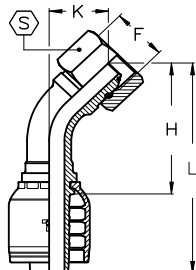
DKOR45

FGOL - Loose nut (Dado libero)

FGOS - Tieffe nut (Dado TIEFFE)

TIEFFE Part.N.	Hose Size			BSP Connection Size		Dimensions (mm)					Maximum W.P.	
	DN	Inch	Dash	F	Dash	H	L	K	S	O-RING	bar	PSI
HX0404FGOL45	6,3	1/4"	-04	1/4"-19	-04	35	63	13	19	6,5x1	400	5800
HX0406FGOL45	6,3	1/4"	-05	3/8"-19	-06	37	65	15	22	8,5x1,5	400	5800
HX0506FGOL45	8	5/16"	-05	3/8"-19	-06	38	66	15	22	8,5x1,5	350	5000
HX0606FGOL45	10	3/8"	-06	3/8"-19	-06	39	69	15	22	8,5x1,5	330	4800
HX0608FGOL45	10	3/8"	-06	1/2"-14	-08	41	71	18	27	11,5x1,5	330	4800
HX0808FGOL45	12,5	1/2"	-08	1/2"-14	-08	45	78	18	27	11,5x1,5	280	4000
HX0810FGOS45	12,5	1/2"	-08	5/8"-14	-10	51	84	24	30	13x1,5	280	4000
HX1010FGOS45	16	5/8"	-10	5/8"-14	-10	55	91	24	30	13x1,5	280	4000
HX1012FGOS45	16	5/8"	-10	3/4"-14	-12	58	94	27	32	17x1,5	280	4000
HX1212FGOS45	19	3/4"	-12	3/4"-14	-12	66	107	29	32	17x1,5	280	4000
HX1216FGOS45	19	3/4"	-12	1"-11	-16	69	110	32	41	22x1,5	280	4000
HX1616FGOS45	25	1"	-16	1"-11	-16	85	136	37	41	22x1,5	210	3000
HX1620FGOS45	25	1"	-16	1 1/4"-11	-20	85	136	37	50	28,3x1,78	210	3000
HX2020FGOS45	31,5	1 1/4"	-20	1 1/4"-11	-20	99	157	43	50	28,3x1,78	125	1800
HX2024FGOS45	31,5	1 1/4"	-20	1 1/2"-11	-24	99	157	43	55	33,05x1,78	125	1800
HX2424FGOS45	38	1 1/2"	-24	1 1/2"-11	-24	118	182	51	55	33,05x1,78	90	1300
HX2432FGOS45	38	1 1/2"	-24	2"-11	-32	120	190	53	70	44,17x1,78	90	1300
HX3232FGOS45	51	2"	-32	2"-11	-32	164	234	76	70	44,17x1,78	80	1160

**FGOL45
FGOS45**
BSP FEMALE 60° O-RING CONE - 45° ELBOW - FULL EXAGON NUT
 FEMMINA GAS OGIVA 60° O-RING - CURVA A 45° - DADO TUTTO ESAGONO

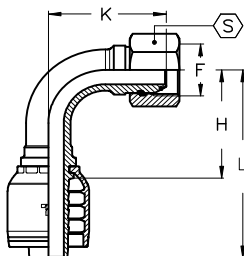
DKOR45

FGOL - Loose nut (Dado libero)

FGOS - Tieffe nut (Dado TIEFFE)

TIEFFE Part.N.	Hose Size			BSP Connection Size		Dimensions (mm)					Maximum W.P.	
	DN	Inch	Dash	F	Dash	H	L	K	S	O-RING	bar	PSI
HX0404FGOL90	6,3	1/4"	-04	1/4"-19	-04	29	57	27	19	6,5x1	400	5800
HX0406FGOL90	6,3	1/4"	-04	3/8"-19	-06	29	57	29	22	8,5x1,5	400	5800
HX0506FGOL90	8	5/16"	-05	3/8"-19	-06	29	57	29	22	8,5x1,5	350	5000
HX0606FGOL90	10	3/8"	-06	3/8"-19	-06	30	61	30	22	8,5x1,5	330	4800
HX0608FGOL90	10	3/8"	-06	1/2"-14	-08	30	61	33	27	11,5x1,5	330	4800
HX0808FGOL90	12,5	1/2"	-08	1/2"-14	-08	37	70	36	27	11,5x1,5	280	4000
HX0810FGOS90	12,5	1/2"	-08	5/8"-14	-10	37	70	45	30	13x1,5	280	4000
HX1010FGOS90	16	5/8"	-10	5/8"-14	-10	44	80	48	30	13x1,5	280	4000
HX1012FGOS90	16	5/8"	-10	3/4"-14	-12	44	80	51	32	17x1,5	280	4000
HX1212FGOS90	19	3/4"	-12	3/4"-14	-12	54	94	57	32	17x1,5	280	4000
HX1216FGOS90	19	3/4"	-12	1"-11	-16	54	94	61	41	22x1,5	280	4000
HX1616FGOS90	25	1"	-16	1"-11	-16	70	121	73	41	22x1,5	210	3000
HX1620FGOS90	25	1"	-16	1 1/4"-11	-20	70	121	75	50	28,3x1,78	210	3000
HX2020FGOS90	31,5	1 1/4"	-20	1 1/4"-11	-20	84	142	88	50	28,3x1,78	125	1800
HX2024FGOS90	31,5	1 1/4"	-20	1 1/2"-11	-24	84	142	88	55	33,05x1,78	125	1800
HX2424FGOS90	38	1 1/2"	-24	1 1/2"-11	-24	100	165	104	55	33,05x1,78	90	1300
HX2432FGOS90	38	1 1/2"	-24	2"-11	-32	100	165	107	70	44,17x1,78	90	1300
HX3232FGOS90	51	2"	-32	2"-11	-32	134	204	152	70	44,17x1,78	80	1160

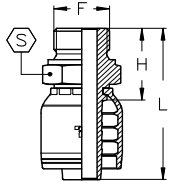
MGF
BSP PARALLEL MALE FLAT SEAT
MASCHIO GAS CILINDRICO SEDE PIANA
AGR
FLAT SEAT

TIEFFE Part.N.	Hose Size			BSP Connection Size		Dimensions (mm)						Maximum W.P.	
	DN	Inch	Dash	F	Dash	H	L	S				bar	PSI
HX0404MGF	6,3	1/4"	-04	1/4"-19	-04	25	53	19				400	5800
HX0406MGF	6,3	1/4"	-04	3/8"-19	-06	27	55	22				400	5800
HX0506MGF	8	5/16"	-05	3/8"-19	-06	27	55	22				350	5000
HX0606MGF	10	3/8"	-06	3/8"-19	-06	27	58	22				330	4800
HX0608MGF	10	3/8"	-06	1/2"-14	-08	32	62	27				330	4800
HX0808MGF	12,5	1/2"	-08	1/2"-14	-08	33	66	27				280	4000
HX0810MGF	12,5	1/2"	-08	5/8"-14	-10	35	68	30				280	4000
HX0812MGF	12,5	1/2"	-08	3/4"-14	-12	36	69	32				280	4000
HX1010MGF	16	5/8"	-10	5/8"-14	-10	35	71	30				280	4000
HX1012MGF	16	5/8"	-10	3/4"-14	-12	36	72	32				280	4000
HX1212MGF	19	3/4"	-12	3/4"-14	-12	37	77	32				280	4000
HX1216MGF	19	3/4"	-12	1"-11	-16	42	82	41				280	4000
HX1616MGF	25	1"	-16	1"-11	-16	43	94	41				210	3000
HX2020MGF	31,5	1 1/4"	-20	1 1/4"-11	-20	47	105	50				125	1800

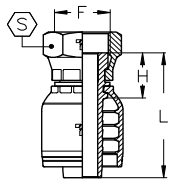
FGFP
BSP FEMALE FLAT SEAT - CRIMPED-BACK NUT
FEMMINA GAS SEDE PIANA - DADO PRESSATO
DKR
FLAT SEAT

TIEFFE Part.N.	Hose Size			BSP Connection Size		Dimensions (mm)						Maximum W.P.	
	DN	Inch	Dash	F	Dash	H	L	S				bar	PSI
HX0404FGFP	6,3	1/4"	-04	1/4"-19	-04	15	43	19				400	5800
HX0406FGFP	6,3	1/4"	-04	3/8"-19	-06	18	46	22				400	5800
HX0506FGFP	8	5/16"	-05	3/8"-19	-06	18	46	22				350	5000
HX0606FGFP	10	3/8"	-06	3/8"-19	-06	17	47	22				330	4800
HX0608FGFP	10	3/8"	-06	1/2"-14	-08	19	49	27				330	4800
HX0808FGFP	12,5	1/2"	-08	1/2"-14	-08	19	52	27				280	4000
HX0810FGFP	12,5	1/2"	-08	5/8"-14	-10	21	54	30				280	4000
HX0812FGFP	12,5	1/2"	-08	3/4"-14	-12	23	56	32				280	4000
HX1010FGFP	16	5/8"	-10	5/8"-14	-10	20	56	30				280	4000
HX1012FGFP	16	5/8"	-10	3/4"-14	-12	23	59	32				280	4000
HX1212FGFP	19	3/4"	-12	3/4"-14	-12	22	63	32				280	4000
HX1216FGFP	19	3/4"	-12	1"-11	-16	25	65	41				280	4000
HX1616FGFP	25	1"	-16	1"-11	-16	25	76	41				210	3000
HX2020FGFP	31,5	1 1/4"	-20	1 1/4"-11	-20	28	90	50				125	1800

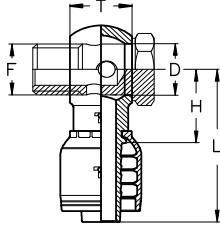
OG
**BSP BANJO
OCCHIO BSP GAS**
RNR

TIEFFE Part.N.	Hose Bore			BSP BOLT Thread F	Dimensions (mm)					Maximum W.P.		
	DN	Inch	Size		H	L	D	T		bar	PSI	
HX0302OG	5	3/16"	-03	1/8"-28	20	45	10,2	10			280	4000
HX0304OG	5	3/16"	-03	1/4"-19	22,6	47,6	13,3	14			280	4000
HX0402OG	6,3	1/4"	-04	1/8"-28	23	51	10,2	10			280	4000
HX0404OG	6,3	1/4"	-04	1/4"-19	23	51	13,3	14			280	4000
HX0406OG	6,3	1/4"	-04	3/8"-19	26,5	54,5	16,8	17,5			280	4000
HX0408OG	6,3	1/4"	-04	1/2"-14	33,5	61,5	21	23			250	3600
HX0504OG	8	5/16"	-05	1/4"-19	24	52	13,3	14			280	4000
HX0506OG	8	5/16"	-05	3/8"-19	26,5	54,5	16,8	17,5			280	4000
HX0508OG	8	5/16"	-05	1/2"-14	33,5	61,5	21	23			250	3600
HX0604OG	10	3/8"	-06	1/4"-19	24	54,5	13,3	14			280	4000
HX0606OG	10	3/8"	-06	3/8"-19	24	54,5	16,8	17,5			280	4000
HX0608OG	10	3/8"	-06	1/2"-14	32	62,5	21	23			250	3600
HX0806OG	12,5	1/2"	-08	3/8"-19	26,5	59,5	16,8	17,5			280	4000
HX0808OG	12,5	1/2"	-08	1/2"-14	28,5	61,5	21	23			250	3600
HX0810OG	12,5	1/2"	-08	5/8"-14	31	64	23,1	23,5			210	3000
HX0812OG	12,5	1/2"	-08	3/4"-14	39	72	26,5	29,5			210	3000
HX1008OG	16	5/8"	-10	1/2"-14	27,2	63	21	23			250	3600
HX1010OG	16	5/8"	-10	5/8"-14	28,2	64	23,1	23,5			210	3000
HX1012OG	16	5/8"	-10	3/4"-14	34,7	70,5	26,5	29,5			210	3000
HX1212OG	19	3/4"	-12	3/4"-14	37,5	78	26,5	29,5			210	3000
HX1216OG	19	3/4"	-12	1"-11	39,5	90,5	33,5	37,5			165	2400
HX1616OG	25	1"	-16	1"-11	49	100	33,5	37,5			165	2400

MI
JIC MALE 37° CONE
 MASCHIO JIC CONO 37°

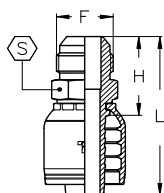
AGJ

TIEFFE Part.N.	Hose Size			JIC 37° Connection Size		Dimensions (mm)				Maximum W.P.	
	DN	Inch	Dash	F	Dash	H	L	S		bar	PSI
HX0304MI	5	3/16"	-03	7/16"-20	-04	25	50	12		415	6000
HX0305MI	5	3/16"	-03	1/2"-20	-05	25	50	14		415	6000
HX0404MI	6,3	1/4"	-04	7/16"-20	-04	25,5	53,5	12		400	5800
HX0405MI	6,3	1/4"	-04	1/2"-20	-05	25,5	53,5	14		400	5800
HX0406MI	6,3	1/4"	-04	9/16"-18	-06	26,6	54,6	15		350	5000
HX0505MI	8	5/16"	-05	1/2"-20	-05	25,5	53,5	14		350	5000
HX0506MI	8	5/16"	-05	9/16"-18	-06	26,6	54,6	15		350	5000
HX0508MI	8	5/16"	-05	3/4"-16	-08	29,7	57,7	19		350	5000
HX0606MI	10	3/8"	-06	9/16"-18	-06	26,6	57,1	15		330	4800
HX0608MI	10	3/8"	-06	3/4"-16	-08	29,7	60,2	19		330	4800
HX0610MI	10	3/8"	-06	7/8"-14	-10	34,3	64,8	24		330	4800
HX0808MI	12,5	1/2"	-08	3/4"-16	-08	30,7	63,7	19		280	4000
HX0810MI	12,5	1/2"	-08	7/8"-14	-10	35,3	68,3	24		280	4000
HX0812MI	12,5	1/2"	-08	1 1/16"-12	-12	38,9	71,9	27		280	4000
HX1010MI	16	5/8"	-10	7/8"-14	-10	35,5	71,3	24		280	4000
HX1012MI	16	5/8"	-10	1 1/16"-12	-12	39,1	74,9	27		280	4000
HX1210MI	19	3/4"	-12	7/8"-14	-10	37,3	77,8	27		280	4000
HX1212MI	19	3/4"	-12	1 1/16"-12	-12	39,9	80,4	27		280	4000
HX1214MI	19	3/4"	-12	1 3/16"-12	-14	41,6	82,1	32		280	4000
HX1216MI	19	3/4"	-12	1 5/16"-12	-16	42,1	82,6	34		280	4000
HX1612MI	25	1"	-16	1 1/16"-12	-12	41,9	92,9	32		210	3000
HX1616MI	25	1"	-16	1 5/16"-12	-16	43,6	94,6	34		210	3000
HX1620MI	25	1"	-16	1 5/8"-12	-20	46,8	97,8	42		210	3000
HX2020MI	31,5	1 1/4"	-20	1 5/8"-12	-20	47,6	105,3	42		125	1800
HX2024MI	31,5	1 1/4"	-20	1 7/8"-12	-24	52,8	110,5	50		125	1800
HX2424MI	38	1 1/2"	-24	1 7/8"-12	-24	53	117,5	50		90	1300
HX3232MI	51	2"	-32	2 1/2"-12	-32	63,4	133,4	65		80	1160

FIP
JIC FEMALE 37° CONE SEAT - CRIMPED-BACK NUT
 FEMMINA JIC SVASATA 37° - DADO PRESSATO

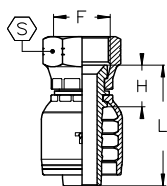
DKJ

TIEFFE Part.N.	Hose Size			JIC 37° Connection Size		Dimensions (mm)				Maximum W.P.	
	DN	Inch	Dash	F	Dash	H	L	S		bar	PSI
HX0304FIP	5	3/16"	03	7/16"-20	-04	13,5	38,5	14		415	6000
HX0305FIP	5	3/16"	03	1/2"-20	-05	15	40	17		415	6000
HX0404FIP	6,3	1/4"	-04	7/16"-20	-04	14	42	14		400	5800
HX0405FIP	6,3	1/4"	-04	1/2"-20	-05	14,5	42,5	17		400	5800
HX0406FIP	6,3	1/4"	-04	9/16"-18	-06	16,5	44,5	19		350	5000
HX0505FIP	8	5/16"	-05	1/2"-20	-05	14,5	42,5	17		350	5000
HX0506FIP	8	5/16"	-05	9/16"-18	-06	15,5	43,5	19		350	5000
HX0508FIP	8	5/16"	-05	3/4"-16	-08	17,5	45,5	22		350	5000
HX0606FIP	10	3/8"	-06	9/16"-18	-06	15,5	46	19		330	4800
HX0608FIP	10	3/8"	-06	3/4"-16	-08	17,5	48	22		330	4800
HX0610FIP	10	3/8"	-06	7/8"-14	-10	18,5	48	27		330	4800
HX0808FIP	12,5	1/2"	-08	3/4"-16	-08	17,5	50,5	22		280	4000
HX0810FIP	12,5	1/2"	-08	7/8"-14	-10	18,5	51,5	27		280	4000
HX0812FIP	12,5	1/2"	-08	1 1/16"-12	-12	21,8	54,8	32		280	4000
HX1010FIP	16	5/8"	-10	7/8"-14	-10	18,7	54,5	27		280	4000
HX1012FIP	16	5/8"	-10	1 1/16"-12	-12	22	57,8	32		280	4000
HX1210FIP	19	3/4"	-12	7/8"-14	-10	19,5	60	27		280	4000
HX1212FIP	19	3/4"	-12	1 1/16"-12	-12	21,3	61,8	32		280	4000
HX1214FIP	19	3/4"	-12	1 3/16"-12	-14	25	65,5	36		280	4000
HX1216FIP-EX38	19	3/4"	-12	1 5/16"-12	-16	25,5	66	38		280	4000
HX1216FIP	19	3/4"	-12	1 5/16"-12	-16	25,5	66	41		280	4000
HX1612FIP	25	1"	-16	1 1/16"-12	-12	22,8	73,8	32		210	3000
HX1616FIP-EX38	25	1"	-16	1 5/16"-12	-16	25,5	76,5	38		210	3000
HX1616FIP	25	1"	-16	1 5/16"-12	-16	25,5	76,5	41		210	3000
HX1620FIP	25	1"	-16	1 5/8"-12	-20	28,5	79,5	50		210	3000
HX2020FIP	31,5	1 1/4"	-20	1 5/8"-12	-20	27,8	85,5	50		125	1800
HX2024FIP-EX55	31,5	1 1/4"	-20	1 7/8"-12	-24	31,3	89	55		125	1800
HX2024FIP	31,5	1 1/4"	-20	1 7/8"-12	-24	31,3	89	60		125	1800
HX2424FIP-EX55	38	1 1/2"	-24	1 7/8"-12	-24	30	94,5	55		90	1300
HX2424FIP	38	1 1/2"	-24	1 7/8"-12	-24	30	94,5	60		90	1300
HX3232FIP-EX70	51	2"	-32	2 1/2"-12	-32	34	104	70		80	1160
HX3232FIP	51	2"	-32	2 1/2"-12	-32	34	104	75		80	1160

FICP
JIC FEMALE 37° CONE SEAT - DOUBLE EXAGON - CRIMPED-BACK NUT
 FEMMINA JIC SVASATA 37° - DOPPIO ESAGONO - DADO PRESSATO

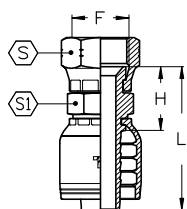
DKJ

TIEFFE Part.N.	Hose Size			JIC 37° Connection Size		Dimensions (mm)					Maximum W.P.	
	DN	Inch	Dash	F	Dash	H	L	S	S1	bar	PSI	
HX0304FICP	5	3/16"	-03	7/16"-20	-04	19	44	14	12	415	6000	
HX0404FICP	6,3	1/4"	-04	7/16"-20	-04	20,5	48,5	14	14	415	6000	
HX0405FICP	6,3	1/4"	-04	1/2"-20	-05	21	49	17	14	400	5800	
HX0406FICP	6,3	1/4"	-04	9/16"-18	-06	22	50	19	14	350	5000	
HX0505FICP	8	5/16"	-05	1/2"-20	-05	21	49	17	14	350	5000	
HX0506FICP	8	5/16"	-05	9/16"-18	-06	22,5	50,5	19	16	350	5000	
HX0604FICP	10	3/8"	-06	7/16"-20	-04	21	51,5	14	16	330	4800	
HX0605FICP	10	3/8"	-06	1/2"-20	-05	21,5	52	17	16	330	4800	
HX0606FICP	10	3/8"	-06	9/16"-18	-06	22,5	53	19	16	330	4800	
HX0608FICP	10	3/8"	-06	3/4"-16	-08	24,5	55	22	19	330	4800	
HX0610FICP	10	3/8"	-06	7/8"-14	-10	36,5	57	27	22	330	4800	
HX0806FICP	12,5	1/2"	-08	9/16"-18	-06	24,5	57,5	19	19	280	4000	
HX0808FICP	12,5	1/2"	-08	3/4"-16	-08	25,5	58,5	22	19	280	4000	
HX0810FICP	12,5	1/2"	-08	7/8"-14	-10	27,5	60,5	27	22	280	4000	
HX0812FICP	12,5	1/2"	-08	1 1/16"-12	-12	30,3	63,3	32	25	280	4000	
HX1008FICP	16	5/8"	-10	3/4"-16	-08	26,7	62,5	22	22	280	4000	
HX1010FICP	16	5/8"	-10	7/8"-14	-10	27,7	63,5	27	22	280	4000	
HX1012FICP	16	5/8"	-10	1 1/16"-12	-12	30,5	66,3	32	25	280	4000	
HX1210FICP	19	3/4"	-12	7/8"-14	-10	30	70,5	27	27	280	4000	
HX1212FICP	19	3/4"	-12	1 1/16"-12	-12	31,8	72,3	32	27	280	4000	
HX1214FICP	19	3/4"	-12	1 3/16"-12	-14	34,5	75	36	30	280	4000	
HX1216FICP-EX38	19	3/4"	-12	1 5/16"-12	-16	35,5	76	38	32	280	4000	
HX1216FICP	19	3/4"	-12	1 5/16"-12	-16	35,5	76	41	32	280	4000	
HX1612FICP	25	1"	-16	1 1/16"-12	-12	34,3	85,3	32	32	210	3000	
HX1616FICP-EX38	25	1"	-16	1 5/16"-12	-16	37	88	38	32	210	3000	
HX1616FICP	25	1"	-16	1 5/16"-12	-16	37	88	41	32	210	3000	
HX1620FICP	25	1"	-16	1 5/8"-12	-20	42	93	50	41	210	3000	
HX2020FICP	31,5	1 1/4"	-20	1 5/8"-12	-20	42,8	100,5	50	41	125	1800	
HX2424FICP-EX55	38	1 1/2"	-24	1 7/8"-12	-24	47	111,5	55	46	90	1300	
HX2424FICP	38	1 1/2"	-24	1 7/8"-12	-24	47	111,5	60	46	90	1300	
HX3232FICP-EX70	51	2"	-32	2 1/2"-12	-32	55,5	125,5	70	60	80	1160	
HX3232FICP	51	2"	-32	2 1/2"-12	-32	55,5	125,5	75	60	80	1160	

FICS
JIC FEMALE 37° CONE SEAT - DOUBLE EXAGON - TIEFFE NUT
 FEMMINA JIC SVASATA 37° - DOPPIO ESAGONO - DADO TIEFFE

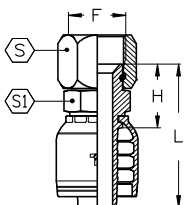
DKJ

TIEFFE Part.N.	Hose Size			JIC 37° Connection Size		Dimensions (mm)					Maximum W.P.	
	DN	Inch	Dash	F	Dash	H	L	S	S1	bar	PSI	
HX0810FICS	12,5	1/2"	-08	7/8"-14	-10	29	62	27	22	280	4000	
HX1010FICS	16	5/8"	-10	7/8"-14	-10	29,2	65	27	22	280	4000	
HX1012FICS	16	5/8"	-10	1 1/16"-12	-12	31,4	67,2	32	25	280	4000	
HX1212FICS	19	3/4"	-12	1 1/16"-12	-12	32,7	73,2	32	27	280	4000	
HX1214FICS	19	3/4"	-12	1 3/16"-12	-14	34,7	75,2	36	30	280	4000	
HX1216FICS	19	3/4"	-12	1 5/16"-12	-16	36,5	77	41	32	280	4000	
HX1616FICS	25	1"	-16	1 5/16"-12	-16	38	89	41	32	210	3000	
HX1620FICS	25	1"	-16	1 5/8"-12	-20	44	95	50	41	210	3000	
HX2020FICS	31,5	1 1/4"	-20	1 5/8"-12	-20	44,8	102,5	50	41	125	1800	
HX2424FICS	38	1 1/2"	-24	1 7/8"-12	-24	48	112,5	60	46	90	1300	
HX3232FICS	51	2"	-32	2 1/2"-12	-32	59,5	129,5	75	60	80	1160	

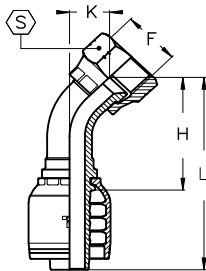
FIP45
JIC FEMALE 37° CONE SEAT - 45° ELBOW - CRIMPED-BACK NUT
FEMMINA JIC SVASATA 37° - CURVA A 45° - DADO PRESSATO
DKJ45

TIEFFE Part.N.	Hose Size			JIC 37° Connection Size		Dimensions (mm)					Maximum W.P.	
	DN	Inch	Dash	F	Dash	H	L	K	S	bar	PSI	
HX0304FIP45	5	3/16"	03	7/16"-20	-04	29	54	10	14	415	6000	
HX0305FIP45	5	3/16"	03	1/2"-20	-05	30	55	11	17	415	6000	
HX0404FIP45	6,3	1/4"	-04	7/16"-20	-04	31	59	10	14	400	5800	
HX0405FIP45	6,3	1/4"	-04	1/2"-20	-05	32	60	11	17	400	5800	
HX0406FIP45	6,3	1/4"	-04	9/16"-18	-06	33	61	12	19	350	5000	
HX0505FIP45	8	5/16"	-05	1/2"-20	-05	33	61	11	17	350	5000	
HX0506FIP45	8	5/16"	-05	9/16"-18	-06	34	62	12	19	350	5000	
HX0508FIP45	8	5/16"	-05	3/4"-16	-08	36	64	14	22	350	5000	
HX0606FIP45	10	3/8"	-06	9/16"-18	-06	35,5	66	12	19	330	4800	
HX0608FIP45	10	3/8"	-06	3/4"-16	-08	37,5	68	14	22	330	4800	
HX0610FIP45	10	3/8"	-06	7/8"-14	-10	39,5	70	16	27	330	4800	
HX0808FIP45	12,5	1/2"	-08	3/4"-16	-08	41	37	14,5	22	280	4000	
HX0810FIP45	12,5	1/2"	-08	7/8"-14	-10	43	76	16	27	280	4000	
HX0812FIP45	12,5	1/2"	-08	1 1/16"-12	-12	45,5	78,5	19	32	280	4000	
HX1010FIP45	16	5/8"	-10	7/8"-14	-10	47	83	16	27	280	4000	
HX1012FIP45	16	5/8"	-10	1 1/16"-12	-12	50	86	19	32	280	4000	
HX1210FIP45	19	3/4"	-12	7/8"-14	-10	64	105	27	27	280	4000	
HX1212FIP45	19	3/4"	-12	1 1/16"-12	-12	59	99	22	32	280	4000	
HX1214FIP45	19	3/4"	-12	1 3/16"-12	-14	59	100	22	36	280	4000	
HX1216FIP45-EX38	19	3/4"	-12	1 5/16"-12	-16	61	101	24	38	280	4000	
HX1216FIP45	19	3/4"	-12	1 5/16"-12	-16	61	101	24	41	280	4000	
HX1612FIP45	25	1"	-16	1 1/16"-12	-12	83	134	35	32	210	3000	
HX1616FIP45-EX38	25	1"	-16	1 5/16"-12	-16	72	123	24	38	210	3000	
HX1616FIP45	25	1"	-16	1 5/16"-12	-16	72	123	24	41	210	3000	
HX1620FIP45	25	1"	-16	1 5/8"-12	-20	76	127	28	50	210	3000	
HX2020FIP45	31,5	1 1/4"	-20	1 5/8"-12	-20	95	153	38	50	125	1800	
HX2024FIP45-EX55	31,5	1 1/4"	-20	1 7/8"-12	-24	88	144	32	55	125	1800	
HX2024FIP45	31,5	1 1/4"	-20	1 7/8"-12	-24	88	144	32	60	125	1800	
HX2424FIP45-EX55	38	1 1/2"	-24	1 7/8"-12	-24	113	178	46	55	90	1300	
HX2424FIP45	38	1 1/2"	-24	1 7/8"-12	-24	113	178	46	60	90	1300	
HX3232FIP45-EX70	51	2"	-32	2 1/2"-12	-32	150	220	61	70	80	1160	
HX3232FIP45	51	2"	-32	2 1/2"-12	-32	150	220	61	75	80	1160	

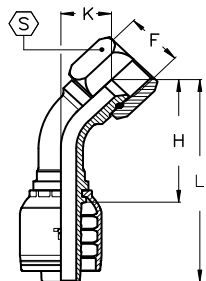
FIS45
JIC FEMALE 37° CONE SEAT - 45° ELBOW - TIEFFE NUT
FEMMINA JIC SVASATA 37° - CURVA A 45° - DADO TIEFFE
DKJ45

TIEFFE Part.N.	Hose Size			JIC 37° Connection Size		Dimensions (mm)					Maximum W.P.	
	DN	Inch	Dash	F	Dash	H	L	K	S	bar	PSI	
HX0810FIS45	12,5	1/2"	-08	7/8"-14	-10	47,5	80,5	21	27	280	4000	
HX1010FIS45	16	5/8"	-10	7/8"-14	-10	53	89	22,5	27	280	4000	
HX1012FIS45	16	5/8"	-10	1 1/16"-12	-12	54,5	90,5	23,5	32	280	4000	
HX1212FIS45	19	3/4"	-12	1 1/16"-12	-12	63	104	26	32	280	4000	
HX1214FIS45	19	3/4"	-12	1 3/16"-12	-14	64	105	27	36	280	4000	
HX1216FIS45	19	3/4"	-12	1 5/16"-12	-16	65	106	28	41	280	4000	
HX1616FIS45	25	1"	-16	1 5/16"-12	-16	83	134	34	41	210	3000	
HX1620FIS45	25	1"	-16	1 5/8"-12	-20	83	134	34	50	210	3000	
HX2020FIS45	31,5	1 1/4"	-20	1 5/8"-12	-20	96	154	39	50	125	1800	
HX2424FIS45	38	1 1/2"	-24	1 7/8"-12	-24	113	178	46	60	90	1300	
HX3232FIS45	51	2"	-32	2 1/2"-12	-32	152	222	63	75	80	1160	

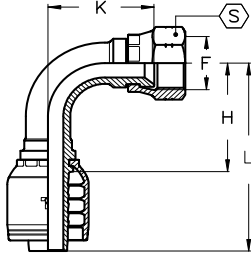
FIP90
JIC FEMALE 37° CONE SEAT - 90° ELBOW - CRIMPED-BACK NUT
FEMMINA JIC SVASATA 37° - CURVA A 90° - DADO PRESSATO
DKJ90

TIEFFE Part.N.	Hose Size			JIC 37° Connection Size		Dimensions (mm)				Maximum W.P.	
	DN	Inch	Dash	F	Dash	H	L	K	S	bar	PSI
HX0304FIP90	5	3/16"	-03	7/16"-20	-04	21	46	21	14	415	6000
HX0404FIP90	6,3	1/4"	-04	7/16"-20	-04	25,5	53,5	26	14	400	5800
HX0405FIP90	6,3	1/4"	-04	1/2"-20	-05	25,5	53,5	26	17	400	5800
HX0406FIP90	6,3	1/4"	-04	9/16"-18	-06	25,5	53,5	27	19	350	5000
HX0505FIP90	8	5/16"	-05	1/2"-20	-05	28	56	29	17	350	5000
HX0506FIP90	8	5/16"	-05	9/16"-18	-06	28	56	29	19	350	5000
HX0606FIP90	10	3/8"	-06	9/16"-18	-06	31	61,5	33	19	330	4800
HX0608FIP90	10	3/8"	-06	3/4"-16	-08	31	61,5	33	22	330	4800
HX0808FIP90	12,5	1/2"	-08	3/4"-16	-08	37	70	39	22	330	4800
HX0810FIP90	12,5	1/2"	-08	7/8"-14	-10	37	70	40	27	280	4000
HX1010FIP90	16	5/8"	-10	7/8"-14	-10	45	81	45	27	280	4000
HX1012FIP90	16	5/8"	-10	1 1/16"-12	-12	45	81	47	32	280	4000
HX1210FIP90	19	3/4"	-12	7/8"-14	-10	55	95	54	27	280	4000
HX1212FIP90	19	3/4"	-12	1 1/16"-12	-12	55	95	53	32	280	4000
HX1214FIP90	19	3/4"	-12	1 3/16"-12	-14	55	95	54	36	280	4000
HX1216FIP90-EX38	19	3/4"	-12	1 5/16"-12	-16	55	95	56	38	280	4000
HX1216FIP90	19	3/4"	-12	1 5/16"-12	-16	55	95	56	41	280	4000
HX1612FIP90	25	1"	-16	1 1/16"-12	-12	71	122	71	32	210	3000
HX1616FIP90-EX38	25	1"	-16	1 5/16"-12	-16	71	122	70	38	210	3000
HX1616FIP90	25	1"	-16	1 5/16"-12	-16	71	122	70	41	210	3000
HX1620FIP90	25	1"	-16	1 5/8"-12	-20	71	122	70	50	210	3000
HX2020FIP90	31,5	1 1/4"	-20	1 5/8"-12	-20	86	143	82	50	125	1800
HX2024FIP90-EX55	31,5	1 1/4"	-20	1 7/8"-12	-24	86	143	82	55	125	1800
HX2024FIP90	31,5	1 1/4"	-20	1 7/8"-12	-24	86	143	82	60	125	1800
HX2424FIP90-EX55	38	1 1/2"	-24	1 7/8"-12	-24	102	167	96	55	90	1300
HX2424FIP90	38	1 1/2"	-24	1 7/8"-12	-24	102	167	96	60	90	1300
HX3232FIP90-EX70	51	2"	-32	2 1/2"-12	-32	137	207	134	70	80	1160
HX3232FIP90	51	2"	-32	2 1/2"-12	-32	137	207	134	75	80	1160

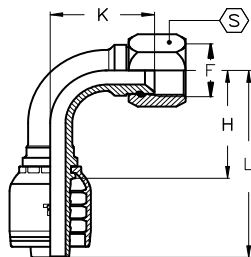
FIS90
JIC FEMALE 37° CONE SEAT - 90° ELBOW - TIEFFE NUT
FEMMINA JIC SVASATA 37° - CURVA A 90° - DADO TIEFFE
DKJ90

TIEFFE Part.N.	Hose Size			JIC 37° Connection Size		Dimensions (mm)				Maximum W.P.	
	DN	Inch	Dash	F	Dash	H	L	K	S	bar	PSI
HX0810FIS90	12,5	1/2"	-08	7/8"-14	-10	37	70	40	27	280	4000
HX1010FIS90	16	5/8"	-10	7/8"-14	-10	45	81	45	27	280	4000
HX1012FIS90	16	5/8"	-10	1 1/16"-12	-12	45	81	47	32	280	4000
HX1212FIS90	19	3/4"	-12	1 1/16"-12	-12	55	95	53	32	280	4000
HX1214FIS90	19	3/4"	-12	1 3/16"-12	-14	55	95	54	36	280	4000
HX1216FIS90	19	3/4"	-12	1 5/16"-12	-16	55	95	56	41	280	4000
HX1616FIS90	25	1"	-16	1 5/16"-12	-16	71	122	70	41	210	3000
HX1620FIS90	25	1"	-16	1 5/8"-12	-20	71	122	70	50	210	3000
HX2020FIS90	31,5	1 1/4"	-20	1 5/8"-12	-20	86	143	82	50	125	1800
HX2424FIS90	38	1 1/2"	-24	1 7/8"-12	-24	102	167	96	60	90	1300
HX3232FIS90	51	2"	-32	2 1/2"-12	-32	137	207	134	75	80	1160

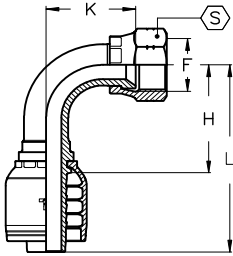
FIP90C
JIC FEMALE 37° CONE SEAT - 90° ELBOW - SHORT DROP - CRIMPED-BACK NUT
FEMMINA JIC SVASATA 37° - CURVA A 90° CORTA - DADO PRESSATO
DKJ90
 SHORT DROP

TIEFFE Part.N.	Hose Size			JIC 37° Connection Size		Dimensions (mm)					Maximum W.P.	
	DN	Inch	Dash	F	Dash	H	L	K	S	bar	PSI	
HX0304FIP90C	5	3/16"	-03	7/16"-20	-04	21	46	18	14		415	6000
HX0305FIP90C	5	3-16"	-03	1/2"-20	-05	21	46	19	17		415	6000
HX0404FIP90C	6,3	1/4"	-04	7/16"-20	-04	25,5	53,5	20	14		400	5800
HX0405FIP90C	6,3	1/4"	-04	1/2"-20	-05	25,5	53,5	21	17		400	5800
HX0406FIP90C	6,3	1/4"	-04	9/16"-18	-06	25,5	53,5	23	19		350	5000
HX0505FIP90C	8	5/16"	-05	1/2"-20	-05	28	56	22	17		350	5000
HX0506FIP90C	8	5/16"	-05	9/16"-18	-06	28	56	24	19		350	5000
HX0508FIP90C	8	5/16"	-05	3/4"-16	-08	28	56	27	22		350	5000
HX0606FIP90C	10	3/8"	-06	9/16"-18	-06	30	60,5	23	19		330	4800
HX0608FIP90C	10	3/8"	-06	3/4"-16	-08	31	61,5	29	22		330	4800
HX0610FIP90C	10	3/8"	-06	7/8"-14	-10	31	61,5	31	27		330	4800
HX0808FIP90C	12,5	1/2"	-08	3/4"-16	-12	37	70	29	22		280	4000
HX0810FIP90C	12,5	1/2"	-08	7/8"-14	-10	38	71	33	27		280	4000
HX0812FIP90C	12,5	1/2"	-08	1 1/16"-12	-12	40	73	40	32		280	4000
HX1010FIP90C	16	5/8"	-10	7/8"-14	-10	43	79	33	27		280	4000
HX1012FIP90C	16	5/8"	-10	1 1/16"-12	-12	45	81	40	32		280	4000
HX1212FIP90C	19	3/4"	-12	1 1/16"-12	-12	55	95	43	32		280	4000
HX1214FIP90C	19	3/4"	-12	1 3/16"-12	-14	55	95	47	36		280	4000
HX1216FIP90C-EX38	19	3/4"	-12	1 5/16"-12	-16	55	95	49	38		280	4000
HX1216FIP90C	19	3/4"	-12	1 5/16"-12	-16	55	95	49	41		280	4000
HX1616FIP90C-EX38	25	1"	-16	1 5/16"-12	-16	71	122	56	38		210	3000
HX1616FIP90C	25	1"	-16	1 5/16"-12	-16	71	122	56	41		210	3000
HX1620FIP90C	25	1"	-16	1 5/8"-12	-20	71	122	61	50		210	3000

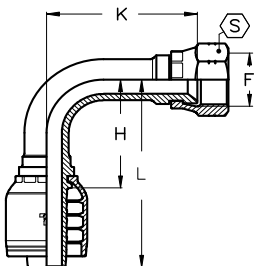
FIP90L
JIC FEMALE 37° CONE SEAT - 90° ELBOW - LONG DROP - CRIMPED-BACK NUT
FEMMINA JIC SVASATA 37° - CURVA A 90° LUNGA - DADO PRESSATO
DKJ90
 LONG DROP

TIEFFE Part.N.	Hose Size			JIC 37° Connection Size		Dimensions (mm)					Maximum W.P.	
	DN	Inch	Dash	F	Dash	H	L	K	S	bar	PSI	
HX0304FIP90L	5	3/16"	-03	7/16"-20	-04	21	46	46	14		415	6000
HX0404FIP90L	6,3	1/4"	-04	7/16"-20	-04	25,5	53,5	46	14		400	5800
HX0405FIP90L	6,3	1/4"	-04	1/2"-20	-05	25,5	53,5	46	17		400	5800
HX0406FIP90L	6,3	1/4"	-04	9/16"-18	-06	25,5	53,5	54	19		350	5000
HX0505FIP90L	8	5/16"	-05	1/2"-20	-05	28	56	46	17		350	5000
HX0506FIP90L	8	5/16"	-05	9/16"-18	-06	28	56	54	19		350	5000
HX0606FIP90L	10	3/8"	-06	9/16"-18	-06	31	61,5	54	19		330	4800
HX0608FIP90L	10	3/8"	-06	3/4"-16	-08	31	61,5	64	22		330	4800
HX0808FIP90L	12,5	1/2"	-08	3/4"-16	-08	38	71	64	22		280	4000
HX0810FIP90L	12,5	1/2"	-08	7/8"-14	-10	38	71	70	27		280	4000
HX1010FIP90L	16	5/8"	-10	7/8"-14	-10	45	81	70	27		280	4000
HX1012FIP90L	16	5/8"	-10	1 1/16"-12	-12	45	81	96	32		280	4000
HX1212FIP90L	19	3/4"	-12	1 1/16"-12	-12	55	95	96	32		280	4000
HX1214FIP90L	19	3/4"	-12	1 3/16"-12	-14	55	95	96	36		280	4000
HX1216FIP90L-EX38	19	3/4"	-12	1 5/16"-12	-16	55	95	114	38		280	4000
HX1216FIP90L	19	3/4"	-12	1 5/16"-12	-16	55	95	114	41		280	4000
HX1616FIP90L-EX38	25	1"	-16	1 5/16"-12	-16	71	122	114	38		210	3000
HX1616FIP90L	25	1"	-16	1 5/16"-12	-16	71	122	114	41		210	3000

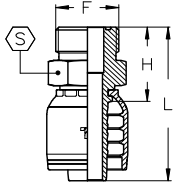
MRS
**ORFS MALE
MASCHIO ORFS**
AG ORFS

TIEFFE Part.N.	Hose Size			ORFS Connection Size		Dimensions (mm)				Maximum W.P.	
	DN	Inch	Dash	F	Dash	H	L	S	O-RING	bar	PSI
HX0404MRS	6,3	1/4"	-04	9/16"-18	-04	23,5	51,5	17	7,65x1,78	400	5800
HX0406MRS	6,3	1/4"	-04	11/16"-16	-06	25,5	53,5	19	9,25x1,78	400	5800
HX0506MRS	8	5/16"	-05	11/16"-16	-06	25,5	53,5	19	9,25x1,78	350	5000
HX0606MRS	10	3/8"	-06	11/16"-16	-06	25,5	56	19	9,25x1,78	330	4800
HX0608MRS	10	3/8"	-06	13/16"-16	-08	28,5	59	22	12,42x1,78	330	4800
HX0610MRS	10	3/8"	-06	1"-14	-10	33	63,5	27	15,6x1,78	330	4800
HX0808MRS	12,5	1/2"	-08	13/16"-16	-08	29,5	62,5	22	12,42x1,78	280	4000
HX0810MRS	12,5	1/2"	-08	1"-14	-10	34	67	27	15,6x1,78	280	4000
HX0812MRS	12,5	1/2"	-08	1 3/16"-12	-12	37	70	32	18,77x1,78	280	4000
HX1010MRS	16	5/8"	-10	1"-14	-10	34	70	27	15,6x1,78	280	4000
HX1012MRS	16	5/8"	-10	1 3/16"-12	-12	37	73	32	18,77x1,78	280	4000
HX1212MRS	19	3/4"	-12	1 3/16"-12	-12	38	78,5	32	18,77x1,78	280	4000
HX1216MRS	19	3/4"	-12	1 7/16"-12	-16	42,5	83	41	23,52x1,78	280	4000
HX1616MRS	25	1"	-16	1 7/16"-12	-16	44	95	41	23,52x1,78	210	3000
HX2020MRS	31,5	1 1/4"	-20	1 11/16"-12	-20	46	104	46	29,87x1,78	125	1800
HX2424MRS	38	1 1/2"	-24	2"-12	-24	50	115	55	37,82x1,78	90	1300

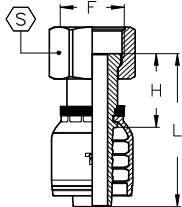
FRS
ORFS FEMALE - SLIP-ON NUT
FEMMINA ORFS - DADO LIBERO
DK ORFS

TIEFFE Part.N.	Hose Size			ORFS Connection Size		Dimensions (mm)					Maximum W.P.	
	DN	Inch	Dash	F	Dash	H	L	S			bar	PSI
HX0404FRS	6	1/4"	-04	9/16"-18	-04	22,5	55	17			400	5800
HX0406FRS	6	1/4"	-04	11/16"-16	-06	25	53	22			400	5800
HX0506FRS	8	5/16"	-05	11/16"-16	-06	25	53	22			350	5000
HX0606FRS	10	3/8"	-06	11/16"-16	-06	24,5	55	22			330	4800
HX0608FRS	10	3/8"	-06	13/16"-16	-08	28,5	59	24			330	4800
HX0610FRS	10	3/8"	-06	1"-14	-10	32,5	63	30			330	4800
HX0808FRS	12,5	1/2"	-08	13/16"-16	-08	28,5	61,5	24			280	4000
HX0810FRS	12,5	1/2"	-08	1"-14	-10	33	66	30			280	4000
HX0812FRS	12,5	1/2"	-08	1 3/16"-12	-12	35,5	68,5	36			280	4000
HX1010FRS	16	5/8"	-10	1"-14	-10	33	68,5	30			280	4000
HX1012FRS	16	5/8"	-10	1 3/16"-12	-12	35,5	71,5	36			280	4000
HX1212FRS	19	3/4"	-12	1 3/16"-12	-12	37,5	78	36			280	4000
HX1216FRS	19	3/4"	-12	1 7/16"-12	-16	39	79,5	41			280	4000
HX1616FRS	25	1"	-16	1 7/16"-12	-16	39,5	90,5	41			210	3000
HX1620FRS	25	1"	-16	1 11/16"-12	-20	40	91	50			210	3000
HX2020FRS	31,5	1 1/4"	-20	1 11/16"-12	-20	40	97,5	50			125	1800
HX2424FRS	38	1 1/2"	-24	2"-12	-24	40	105	60			90	1300

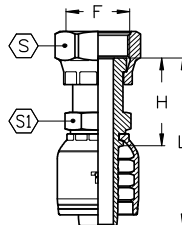
FRC
ORFS FEMALE - DOUBLE EXAGON - CRIMPED-BACK NUT
FEMMINA ORFS - DOPPIO ESAGONO - DADO PRESSATO
DK ORFS

TIEFFE Part.N.	Hose Size			ORFS Connection Size		Dimensions (mm)					Maximum W.P.	
	DN	Inch	Dash	F	Dash	H	L	S	S1		bar	PSI
HX0404FRC	6,3	1/4"	-04	9/16"-18	-04	26,5	54,5	17	14		400	5800
HX0406FRC	6,3	1/4"	-04	11/16"-16	-06	28,5	56,5	22	16		400	5800
HX0504FRC	8	5/16"	-05	9/16"-18	-04	26,5	54,5	17	14		350	5000
HX0506FRC	8	5/16"	-05	11/16"-16	-06	28,5	56,5	22	16		350	5000
HX0604FRC	10	3/8"	-06	9/16"-18	-04	26,5	57	17	16		330	4800
HX0606FRC	10	3/8"	-06	11/16"-16	-06	28,5	59	22	16		330	4800
HX0608FRC	10	3/8"	-06	13/16"-16	-08	32,5	63	24	19		330	4800
HX0806FRC	12,5	1/2"	-08	11/16"-16	-06	30,5	63,5	22	19		280	4000
HX0808FRC	12,5	1/2"	-08	13/16"-16	-08	33,5	66,5	24	19		280	4000
HX0810FRC	12,5	1/2"	-08	1"-14	-10	39,5	72,5	30	24		280	4000
HX0812FRC	12,5	1/2"	-08	1 3/16"-12	-12	43,5	76,5	36	27		280	4000
HX1010FRC	16	5/8"	-10	1"-14	-10	39,5	75,5	30	24		280	4000
HX1012FRC	16	5/8"	-10	1 3/16"-12	-12	43,5	79,5	36	27		280	4000
HX1210FRC	19	3/4"	-12	1"-14	-10	41,5	82	30	27		280	4000
HX1212FRC	19	3/4"	-12	1 3/16"-12	-12	44,5	85	36	27		280	4000
HX1216FRC	19	3/4"	-12	1 7/16"-12	-16	47,5	88	41	36		280	4000
HX1612FRC	25	1"	-16	1 3/16"-12	-12	47	98	36	32		210	3000
HX1616FRC	25	1"	-16	1 7/16"-12	-16	49	100	41	36		210	3000
HX1620FRC	25	1"	-16	1 11/16"-12	-20	50,5	102	50	41		210	3000
HX2020FRC	31,5	1 1/4"	-20	1 11/16"-12	-20	51	109	50	41		125	1800
HX2424FRC	38	1 1/2"	-24	2"-12	-24	54,5	119	60	50		90	1300

FRS45
ORFS FEMALE - 45° ELBOW - SLIP-ON NUT
 FEMMINA ORFS - CURVA A 45° - DADO LIBERO

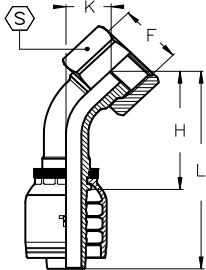
DKORFS45

TIEFFE Part.N.	Hose Size			ORFS Connection Size		Dimensions (mm)						Maximum W.P.	
	DN	Inch	Dash	F	Dash	H	L	K	S			bar	PSI
HX0404FRS45	6,3	1/4"	-04	9/16"-18	-04	32,5	60,5	10,5	17			400	5800
HX0406FRS45	6,3	1/4"	-04	11/16"-16	-06	34,5	62,5	12,5	22			400	5800
HX0504FRS45 *	8	5/16"	-05	9/16"-18	-04	33,5	61,5	11	17			350	5000
HX0506FRS45	8	5/16"	-05	11/16"-16	-06	35	63	12,5	22			350	5000
HX0604FRS45 *	10	3/8"	-06	9/16"-18	-04	35	65,5	11,5	17			330	4800
HX0606FRS45	10	3/8"	-06	11/16"-16	-06	36	66,5	12,5	22			330	4800
HX0608FRS45	10	3/8"	-06	13/16"-16	-08	38,5	69	15	24			330	4800
HX0808FRS45	12,5	1/2"	-08	13/16"-16	-08	42,5	75,5	15,5	24			280	4000
HX0810FRS45	12,5	1/2"	-08	1"-14	-10	45	78	17,5	30			280	4000
HX0812FRS45	12,5	1/2"	-08	1 3/16"-12	-12	47	80	20,5	36			280	4000
HX1010FRS45	16	5/8"	-10	1"-14	-10	49	85	18	30			280	4000
HX1012FRS45	16	5/8"	-10	1 3/16"-12	-12	51,5	87,5	20,5	36			280	4000
HX1212FRS45	19	3/4"	-12	1 3/16"-12	-12	58	99	21	36			280	4000
HX1216FRS45	19	3/4"	-12	1 7/16"-12	-16	60,5	101	23,5	41			280	4000
HX1616FRS45	25	1"	-16	1 7/16"-12	-16	73	124	24	41			210	3000
HX1620FRS45	25	1"	-16	1 11/16"-12	-20	75	126	26,5	50			210	3000
HX2020FRS45	31,5	1 1/4"	-20	1 11/16"-12	-20	84	142	27	50			125	1800
HX2424FRS45	38	1 1/2"	-24	2"-12	-24	98	163	30	60			90	1300

* - Crimped back nut

Dado pressato

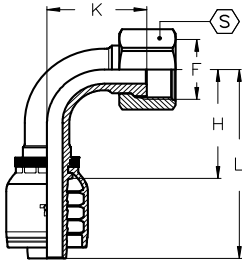
FRS90C
ORFS FEMALE - 90° ELBOW - SHORT DROP - SLIP-ON NUT
FEMMINA ORFS - CURVA A 90° - CORTA - DADO LIBERO
DK ORFS 90
SHORT DROP

* - Crimped back nut

* - Dado pressato

TIEFFE Part.N.	Hose Size			ORFS Connection Size		Dimensions (mm)					Maximum W.P.	
	DN	Inch	Dash	F	Dash	H	L	K	S	bar	PSI	
HX0404FRS90C	6,3	1/4"	-04	9/16"-18	-04	27	55	21	17		400	5800
HX0406FRS90C	6,3	1/4"	-04	11/16"-16	-06	27	55	24	22		400	5800
HX0504FRS90C *	8	5/16"	-05	9/16"-18	-04	29	57	23	17		350	5000
HX0506FRS90C	8	5/16"	-05	11/16"-16	-06	29	57	25	22		350	5000
HX0604FRS90C *	10	3/8"	-06	9/16"-18	-04	30	60,5	22	17		330	4800
HX0606FRS90C	10	3/8"	-06	11/16"-16	-06	31,5	62	24,5	22		330	4800
HX0608FRS90C	10	3/8"	-06	13/16"-16	-08	31	61	30	24		330	4800
HX0808FRS90C	12,5	1/2"	-08	13/16"-16	-08	39	72	31	24		280	4000
HX0810FRS90C	12,5	1/2"	-08	1"-14	-10	39	72	34	30		280	4000
HX0812FRS90C	12,5	1/2"	-08	1 3/16"-12	-12	39	72	42	36		280	4000
HX1010FRS90C	16	5/8"	-10	1"-14	-10	45	81	35	30		280	4000
HX1012FRS90C	16	5/8"	-10	1 3/16"-12	-12	45	81	42	36		280	4000
HX1212FRS90C	19	3/4"	-12	1 3/16"-12	-12	55	95	45	36		280	4000
HX1216FRS90C	19	3/4"	-12	1 7/16"-12	-16	55	95	49	41		280	4000
HX1616FRS90C	25	1"	-16	1 7/16"-12	-16	71	122	55	41		210	3000
HX1620FRS90C	25	1"	-16	1 11/16"-12	-20	71	122	58	50		210	3000
HX2020FRS90C	31,5	1 1/4"	-20	1 11/16"-12	-20	86	143	63	50		125	1800
HX2424FRS90C	38	1 1/2"	-24	2"-12	-24	102	167	73	60		90	1300

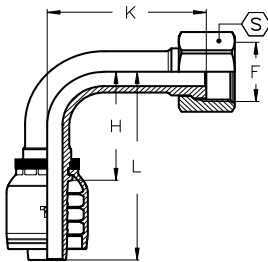
FRS90L
ORFS FEMALE - 90° ELBOW - LONG DROP - SLIP-ON NUT
FEMMINA ORFS - CURVA A 90° - LUNGA - DADO LIBERO
DK ORFS 90
LONG DROP

TIEFFE Part.N.	Hose Size			ORFS Connection Size		Dimensions (mm)					Maximum W.P.	
	DN	Inch	Dash	F	Dash	H	L	K	S	bar	PSI	
HX0404FRS90L	6,3	1/4"	-04	9/16"-18	-04	29	57	46	17		400	5800
HX0406FRS90L	6,3	1/4"	-04	11/16"-16	-06	27	55	54	22		400	5800
HX0606FRS90L	10	3/8"	-06	11/16"-16	-06	34	64,5	54	22		330	4800
HX0608FRS90L	10	3/8"	-06	13/16"-16	-08	34	64,5	64	24		330	4800
HX0808FRS90L	12,5	1/2"	-08	13/16"-16	-08	39	72	64	24		280	4000
HX0810FRS90L	12,5	1/2"	-08	1"-14	-10	39	72	70	30		280	4000
HX1010FRS90L	16	5/8"	-10	1"-14	-10	45	81	70	30		280	4000
HX1212FRS90L	19	3/4"	-12	1 3/16"-12	-12	55	95	96	36		280	4000
HX1616FRS90L	25	1"	-16	1 7/16"-12	-16	71	122	114	41		210	3000

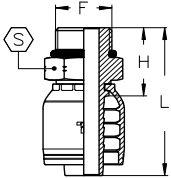
MS
SAE O' RING BOSS MALE
MASCHIO SAE O' RING

TIEFFE Part.N.	Hose Size			SAE Connection Size		Dimensions (mm)						Maximum W.P.	
	DN	Inch	Dash	F	Dash	H	L	S			O-RING	bar	PSI
HX0404MS	6,3	1/4"	-04	7/16"-20	-04	21,5	49,5	14			8,92x1,83	400	5800
HX0405MS	6,3	1/4"	-04	1/2"-20	-05	22	50	16			10,52x1,83	400	5800
HX0406MS	6,3	1/4"	-04	9/16"-18	-06	23,5	51,5	17			11,89x1,98	350	5000
HX0506MS	8	5/16"	-05	9/16"-18	-06	23,5	51,5	17			11,89x1,98	350	5000
HX0606MS	10	3/8"	-06	9/16"-18	-06	23,5	54	17			11,89x1,98	330	4800
HX0608MS	10	3/8"	-06	3/4"-16	-08	26	56,5	22			16,36x2,21	330	4800
HX0808MS	12,5	1/2"	-08	3/4"-16	-08	27	60	22			16,36x2,21	280	4000
HX0810MS	12,5	1/2"	-08	7/8"-14	-10	29,5	62,5	25			19,18x2,46	280	4000
HX0812MS	12,5	1/2"	-08	1 1/16"-12	-12	33,5	66,5	32			23,47x2,95	280	4000
HX1010MS	16	5/8"	-10	7/8"-14	-10	30	65,5	25			19,18x2,46	280	4000
HX1012MS	16	5/8"	-10	1 1/16"-12	-12	34	69,5	32			23,47x2,95	280	4000
HX1212MS	19	3/4"	-12	1 1/16"-12	-12	34,5	75	32			23,47x2,95	280	4000
HX1216MS	19	3/4"	-12	1 5/16"-12	-16	36	76,5	38			29,74x2,95	280	4000
HX1616MS	25	1"	-16	1 5/16"-12	-16	37,5	88,5	38			29,74x2,95	210	3000

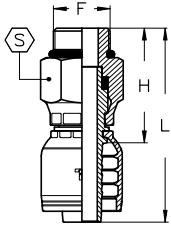
SMS
SAE O' RING BOSS SWIVEL MALE
MASCHIO GIREVOLE SAE O' RING

TIEFFE Part.N.	Hose Size			SAE Connection Size		Dimensions (mm)						Maximum W.P.	
	DN	Inch	Dash	F	Dash	H	L	S			O-RING	bar	PSI
HX0404SMS	6,3	1/4"	-04	7/16"-20	-04	37	65	17			8,92x1,83	400	5800
HX0606SMS	10	3/8"	-06	9/16"-18	-06	42	73	22			11,89x1,98	330	4800
HX0608SMS	10	3/8"	-06	3/4"-16	-08	47	80	27			16,36x2,21	330	4800
HX0808SMS	12,5	1/2"	-08	3/4"-16	-08	49	82	27			16,36x2,21	280	4000
HX0810SMS	12,5	1/2"	-08	7/8"-14	-10	50	83	27			19,18x2,46	280	4000
HX1212SMS	19	3/4"	-12	1 1/16"-12	-12	59	99	34			23,47x2,95	280	4000

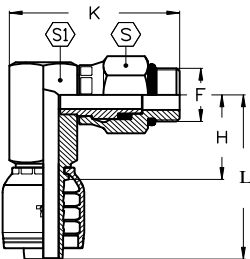
SMS90
SAE O' RING BOSS SWIVEL MALE - 90° COMPACT ELBOW
MASCHIO GIREVOLE SAE O' RING - CURVA A 90° COMPATTA

TIEFFE Part.N.	Hose Size			SAE Connection Size		Dimensions (mm)						Maximum W.P.	
	DN	Inch	Dash	F	Dash	H	L	K	S	S1	O-RING	bar	PSI
HX0606SMS90	10	3/8"	-06	9/16"-18	-06	31	61	47	22	22	11,89x1,98	330	4800
HX0608SMS90	10	3/8"	-06	3/4"-16	-08	34	64	54	27	25	16,36x2,21	330	4800
HX0808SMS90	12,5	1/2"	-08	3/4"-16	-08	33	66	54	27	25	16,36x2,21	280	4000
HX0810SMS90	12,5	1/2"	-08	7/8"-14	-10	33	66	56	27	25	19,18x2,46	280	4000
HX1212SMS90	19	3/4"	-12	1 1/16"-12	-12	43	84	67	34	32	23,47x2,95	280	4000

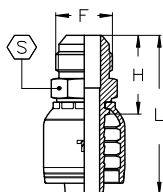
MJ

SAE MALE 45° CONE
MASCHIO SAE CONO 45°

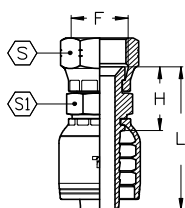
TIEFFE Part.N.	Hose Size			SAE 45° Connection Size		Dimensions (mm)					Maximum W.P.	
	DN	Inch	Dash	F	Dash	H	L	S			bar	PSI
HX0507MJ	8	5/16"	-05	5/8"-18	-07	28,2	56,2	16			400	5800
HX0607MJ	10	3/8"	-06	5/8"-18	-07	28,2	58,7	16			330	4800
HX1212MJ	19	3/4"	-12	1 1/16"-14	-12	43,4	83,9	27			280	4000

FJCP

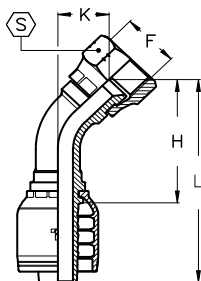
SAE FEMALE 45° CONE SEAT - DOUBLE EXAGON - CRIMPED BACK NUT
FEMMINA SAE SVASATA 45° - DOPPIO ESAGONO - DADO PRESSATO

TIEFFE Part.N.	Hose Size			SAE 45° Connection Size		Dimensions (mm)					Maximum W.P.	
	DN	Inch	Dash	F	Dash	H	L	S	S1		bar	PSI
HX0507FJCP	8	5/16"	-05	5/8"-18	-07	23,5	51,5	22	16		400	5800
HX0607FJCP	10	3/8"	-06	5/8"-18	-07	23,5	54	22	16		330	4800
HX1212FJCP	19	3/4"	-12	1 1/16"-14	-12	31,8	72,3	32	27		280	4000

FJP45

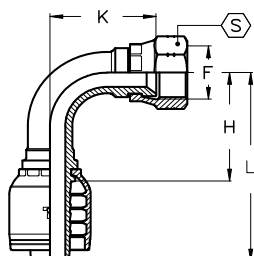
SAE FEMALE 45° CONE SEAT - 45° ELBOW - CRIMPED BACK NUT
FEMMINA SAE SVASATA 45° - CURVA A 45° - DADO PRESSATO

TIEFFE Part.N.	Hose Size			SAE 45° Connection Size		Dimensions (mm)					Maximum W.P.	
	DN	Inch	Dash	F	Dash	H	L	K	S		bar	PSI
HX0507FJP45	8	5/16"	-05	5/8"-18	-07	38	66	16	22		400	5800
HX0607FJP45	10	3/8"	-06	5/8"-18	-07	39	69,5	16	22		330	4800
HX1212FJP45	19	3/4"	-12	1 1/16"-14	-12	62	103	25	32		280	4000

FJP90

SAE FEMALE 45° CONE SEAT - 90° ELBOW - CRIMPED BACK NUT
FEMMINA SAE SVASATA 45° - CURVA A 90° - DADO PRESSATO

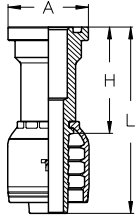
TIEFFE Part.N.	Hose Size			SAE 45° Connection Size		Dimensions (mm)					Maximum W.P.	
	DN	Inch	Dash	F	Dash	H	L	K	S		bar	PSI
HX0507FJP90	8	5/16"	-05	5/8"-18	-07	28	56	29	22		400	5800
HX0607FJP90	10	3/8"	-06	5/8"-18	-07	31	61	31	22		330	4800
HX1212FJP90	20	3/4"	-12	1 1/16"-14	-12	55	95	51	32		280	4000

FL
SAE CODE 61 FLANGE
FLANGIA SAE CODE 61

SFL

TIEFFE Part.N.	Hose Size			Flange Size Connection		Dimensions (mm)					Maximum W.P.	
	DN	Inch	Dash	Inch	Dash	H	L	A			bar	PSI
HX0808FL	12,5	1/2"	-08	1/2"	-08	47	80	30,2			280	4000
HX0810FL *	12,5	1/2"	-08	5/8"	-10	47	80	34			280	4000
HX0812FL	12,5	1/2"	-08	3/4"	-12	47	80	38,1			280	4000
HX1008FL	16	5/8"	-10	1/2"	-08	48	84	30,2			280	4000
HX1010FL *	16	5/8"	-10	5/8"	-10	48	84	34			280	4000
HX1012FL	16	5/8"	-10	3/4"	-12	48	84	38,1			280	4000
HX1208FL	19	3/4"	-12	1/2"	-08	49,5	90	30,2			280	4000
HX1212FL	19	3/4"	-12	3/4"	-12	54	94,5	38,1			280	4000
HX1216FL	19	3/4"	-12	1"	-16	54	94,5	44,5			280	4000
HX1612FL	25	1"	-16	3/4"	-12	55	106	38,1			210	3000
HX1616FL	25	1"	-16	1"	-16	55	106	44,5			210	3000
HX1620FL	25	1"	-16	1 1/4"	-20	55	106	50,8			210	3000
HX2016FL	31,5	1 1/4"	-20	1"	-16	62	120	44,5			125	1800
HX2020FL	31,5	1 1/4"	-20	1 1/4"	-20	62	120	50,8			125	1800
HX2024FL	31,5	1 1/4"	-20	1 1/2"	-24	62	120	60,3			125	1800
HX2424FL	38	1 1/2"	-24	1 1/2"	-24	67,5	132	60,3			90	1300
HX2432FL	38	1 1/2"	-24	2"	-32	67,5	132	71,4			90	1300
HX3232FL	51	2"	-32	2"	-32	70	140	71,4			80	1160
HX3240FL	51	2"	-32	2 1/2"	-40	80	150	84,1			80	1160

* Komatsu style flange
* Flangia Komatsu

FL45
SAE CODE 61 FLANGE - 45° ELBOW
FLANGIA SAE CODE 61 - CURVA A 45°

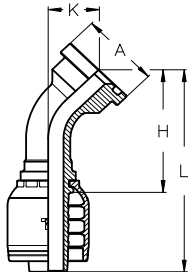
SFL45

TIEFFE Part.N.	Hose Size			Flange Size Connection		Dimensions (mm)					Maximum W.P.	
	DN	Inch	Dash	Inch	Dash	H	L	K	A		bar	PSI
HX0808FL45	12,5	1/2"	-08	1/2"	-08	47	80	20	30,2		280	4000
HX0810FL45 *	12,5	1/2"	-08	5/8"	-10	48	81	22	34		280	4000
HX0812FL45	12,5	1/2"	-08	3/4"	-12	51	84	24	38,1		280	4000
HX1008FL45	16	5/8"	-10	1/2"	-08	51	87	21	30,2		280	4000
HX1010FL45 *	16	5/8"	-10	5/8"	-10	53	89	22	34		280	4000
HX1012FL45	16	5/8"	-10	3/4"	-12	55	91	24	38,1		280	4000
HX1208FL45	19	3/4"	-12	1/2"	-08	64	104	26	30,2		280	4000
HX1212FL45	19	3/4"	-12	3/4"	-12	62	102	25	38,1		280	4000
HX1216FL45	19	3/4"	-12	1"	-16	64	104	27	44,5		280	4000
HX1612FL45	25	1"	-16	3/4"	-12	80	131	30	38,1		210	3000
HX1616FL45	25	1"	-16	1"	-16	77	128	28	44,5		210	3000
HX1620FL45	25	1"	-16	1 1/4"	-20	77	128	28	50,8		210	3000
HX2016FL45	31,5	1 1/4"	-20	1"	-16	94	152	37	44,5		125	1800
HX2020FL45	31,5	1 1/4"	-20	1 1/4"	-20	88	146	32	50,8		125	1800
HX2024FL45	31,5	1 1/4"	-20	1 1/2"	-24	88	146	32	60,3		125	1800
HX2424FL45	38	1 1/2"	-24	1 1/2"	-24	105	169	37	60,3		90	1300
HX2432FL45	38	1 1/2"	-24	2"	-32	105	169	37	71,4		90	1300
HX3232FL45	51	2"	-32	2"	-32	144	214	55	71,4		80	1160
HX3240FL45	51	2"	-32	2 1/2"	-40	142	212	53	84,1		80	1160

* Komatsu style flange
* Flangia Komatsu

FL90
SAE CODE 61 FLANGE - 90° ELBOW
 FLANGIA SAE CODE 61 - CURVA A 90°

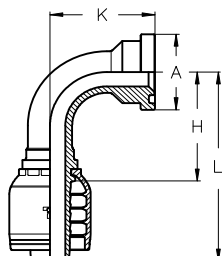
SFL90

* Komatsu style flange

* Flangia Komatsu

TIEFFE Part.N.	Hose Size			Flange Size Connection		Dimensions (mm)					Maximum W.P.		
	DN	Inch	Dash	Inch	Dash	H	L	K	A		bar	PSI	
HX0808FL90	12,5	1/2"	-08	1/2"	-08	38	71	40	30,2			280	4000
HX0810FL90 *	12,5	1/2"	-08	5/8"	-10	38	71	42	34			280	4000
HX0812FL90	12,5	1/2"	-08	3/4"	-12	38	71	45	38,1			280	4000
HX1008FL90	16	5/8"	-10	1/2"	-08	45	81	42	30,2			280	4000
HX1010FL90 *	16	5/8"	-10	5/8"	-10	45	81	44	34			280	4000
HX1012FL90	16	5/8"	-10	3/4"	-12	45	81	47	38,1			280	4000
HX1208FL90	19	3/4"	-12	1/2"	-08	55	95	54	30,2			280	4000
HX1212FL90	19	3/4"	-12	3/4"	-12	55	95	51	38,1			280	4000
HX1216FL90	19	3/4"	-12	1"	-16	55	95	54	44,5			280	4000
HX1612FL90	25	1"	-16	3/4"	-12	70	121	65	38,1			210	3000
HX1616FL90	25	1"	-16	1"	-16	70	121	61	44,5			210	3000
HX1620FL90	25	1"	-16	1 1/4"	-20	70	121	61	50,8			210	3000
HX2016FL90	31,5	1 1/4"	-20	1"	-16	85	142	78	44,5			125	1800
HX2020FL90	31,5	1 1/4"	-20	1 1/4"	-20	85	142	70	50,8			125	1800
HX2024FL90	31,5	1 1/4"	-20	1 1/2"	-24	85	142	70	60,3			125	1800
HX2424FL90	38	1 1/2"	-24	1 1/2"	-24	105	170	83	60,3			90	1300
HX2432FL90	38	1 1/2"	-24	2"	-32	105	170	83	71,4			90	1300
HX3232FL90	51	2"	-32	2"	-32	140	210	122	71,4			80	1160
HX3240FL90	51	2"	-32	2 1/2"	-40	140	210	120	84,1			80	1160

FL 90

LONG DROP

SAE CODE 61 FLANGE - 90° ELBOW - LONG DROP
 FLANGIA SAE CODE 61 - CURVA A 90° - LUNGA

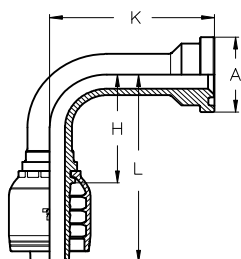
SFL90
 LONG DROP

TIEFFE Part.N.	Hose Size			Flange Size Connection		Dimensions (mm)					Maximum W.P.		
	DN	Inch	Dash	Inch	Dash	H	L	K	A		bar	PSI	
HX0808FL90-K83	12,5	1/2"	-08	1/2"	-08	38	71	83	30,2			280	4000
HX1212FL90-K96	19	3/4"	-12	3/4"	-12	55	95	96	38,1			280	4000
HX1212FL90-K127	19	3/4"	-12	3/4"	-12	55	95	127	38,1			280	4000
HX1216FL90-K79	19	3/4"	-12	1"	-16	55	95	79	44,5			280	4000
HX1616FL90-K118	25	1"	-25	1"	-16	70	121	118	44,5			210	3000
HX1620FL90-K118	25	1"	-25	1 1/4"	-20	70	121	118	50,8			210	3000
HX2020FL90-K91	31,5	1 1/4"	-20	1 1/4"	-20	85	142	91	50,8			125	1800
HX2020FL90-K102	31,5	1 1/4"	-20	1 1/4"	-20	85	142	102	50,8			125	1800
HX2020FL90-K112	31,5	1 1/4"	-20	1 1/4"	-20	85	142	112	50,8			125	1800
HX2020FL90-K130	31,5	1 1/4"	-20	1 1/4"	-20	85	142	130	50,8			125	1800
HX2020FL90-K168	31,5	1 1/4"	-20	1 1/4"	-20	85	142	168	50,8			125	1800
HX2024FL90-K118	31,5	1 1/4"	-20	1 1/2"	-24	85	142	118	60,3			125	1800
HX2024FL90-K130	31,5	1 1/4"	-20	1 1/2"	-24	85	142	130	60,3			125	1800
HX2424FL90-K148	38	1 1/2"	-24	1 1/2"	-24	105	170	148	60,3			90	1300
HX2424FL90-K172	38	1 1/2"	-24	1 1/2"	-24	105	170	172	60,3			90	1300
HX2432FL90-K115	38	1 1/2"	-24	2"	-32	105	170	115	71,4			90	1300
HX2432FL90-K172	38	1 1/2"	-24	2"	-32	105	170	172	71,4			90	1300
HX3232FL90-K165	51	2"	-32	2"	-32	140	210	165	71,4			80	1160
HX3232FL90-K203	51	2"	-32	2"	-32	140	210	203	71,4			80	1160

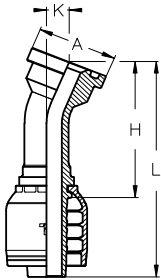
FL22
SAE CODE 61 FLANGE - 22,5° ELBOW
FLANGIA SAE CODE 61 - CURVA A 22,5°
SFL22,5

TIEFFE Part.N.	Hose Size			Flange Size Connection		Dimensions (mm)					Maximum W.P.	
	DN	Inch	Dash	Inch	Dash	H	L	K	A		bar	PSI
HX0808FL22	12,5	1/2"	-08	1/2"	-08	53	86	10	30,2		280	4000
HX0812FL22	12,5	1/2"	-08	3/4"	-12	58	91	11	38,1		280	4000
HX1212FL22	19	3/4"	-12	3/4"	-12	69	110	11	38,1		280	4000
HX1216FL22	19	3/4"	-12	1"	-16	72	112	12	44,5		280	4000
HX1616FL22	25	1"	-16	1"	-16	84	135	12	44,5		210	3000
HX1620FL22	25	1"	-16	1 1/4"	-20	84	135	12	50,8		210	3000
HX2020FL22	31,5	1 1/4"	-20	1 1/4"	-20	97	155	14	50,8		125	1800
HX2024FL22	31,5	1 1/4"	-20	1 1/2"	-24	97	155	14	60,3		125	1800
HX2424FL22	38	1 1/2"	-24	1 1/2"	-24	113	178	18	60,3		90	1300
HX3232FL22	51	2"	-32	2"	-32	159	229	23	71,4		80	1160

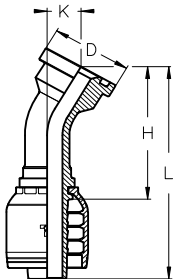
FL30
SAE CODE 61 FLANGE - 30° ELBOW
FLANGIA SAE CODE 61 - CURVA A 30°
SFL30

TIEFFE Part.N.	Hose Size			Flange Size Connection		Dimensions (mm)					Maximum W.P.	
	DN	Inch	Dash	Inch	Dash	H	L	K	A		bar	PSI
HX0808FL30	12,5	1/2"	-08	1/2"	-08	51	84	13	30,2		280	4000
HX0812FL30	12,5	1/2"	-08	3/4"	-12	56	89	16	38,1		280	4000
HX1212FL30	19	3/4"	-12	3/4"	-12	65	106	16	38,1		280	4000
HX1216FL30	19	3/4"	-12	1"	-16	68	108	17	44,5		280	4000
HX1616FL30	25	1"	-16	1"	-16	82	133	17	44,5		210	3000
HX1620FL30	25	1"	-16	1 1/4"	-20	82	133	17	50,8		210	3000
HX2020FL30	31,5	1 1/4"	-20	1 1/4"	-20	95	153	19	50,8		125	1800
HX2024FL30	31,5	1 1/4"	-20	1 1/2"	-24	95	153	19	60,3		125	1800
HX2424FL30	38	1 1/2"	-24	1 1/2"	-24	111	175	25	60,3		90	1300
HX3232FL30	51	2"	-32	2"	-32	156	226	33	71,4		80	1160

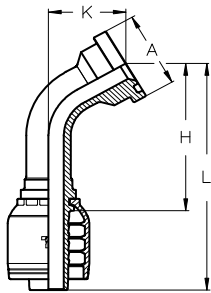
FL60
SAE CODE 61 FLANGE - 60° ELBOW
FLANGIA SAE CODE 61 - CURVA A 60°
SFL60

TIEFFE Part.N.	Hose Size			Flange Size Connection		Dimensions (mm)					Maximum W.P.	
	DN	Inch	Dash	Inch	Dash	H	L	K	A		bar	PSI
HX0808FL60	12,5	1/2"	-08	1/2"	-08	55	88	27	30,2		280	4000
HX0812FL60	12,5	1/2"	-08	3/4"	-12	58	91	32	38,1		280	4000
HX1212FL60	19	3/4"	-12	3/4"	-12	73	113	34	38,1		280	4000
HX1216FL60	19	3/4"	-12	1"	-16	74	114	36	44,5		280	4000
HX1616FL60	25	1"	-16	1"	-16	97	148	39	44,5		210	3000
HX1620FL60	25	1"	-16	1 1/4"	-20	97	148	39	50,8		210	3000
HX2020FL60	31,5	1 1/4"	-20	1 1/4"	-20	115	173	44	50,8		125	1800
HX2024FL60	31,5	1 1/4"	-20	1 1/2"	-24	115	173	44	60,3		125	1800
HX2424FL60	38	1 1/2"	-24	1 1/2"	-24	137	201	51	60,3		90	1300
HX3232FL60	51	2"	-32	2"	-32	188	258	77	71,4		80	1160

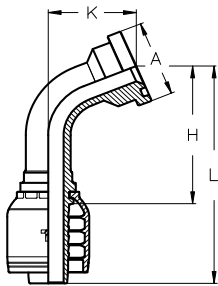
FL67
SAE CODE 61 FLANGE - 67,5° ELBOW
FLANGIA SAE CODE 61 - CURVA A 67,5°
SFL67,5

TIEFFE Part.N.	Hose Size			Flange Size Connection		Dimensions (mm)					Maximum W.P.	
	DN	Inch	Dash	Inch	Dash	H	L	K	A		bar	PSI
HX0808FL67	12,5	1/2"	-08	1/2"	-08	51	84	30	30,2		280	4000
HX0812FL67	12,5	1/2"	-08	3/4"	-12	54	87	36	38,1		280	4000
HX1212FL67	19	3/4"	-12	3/4"	-12	68	108	38	38,1		280	4000
HX1216FL67	19	3/4"	-12	1"	-16	69	109	41	44,5		280	4000
HX1616FL67	25	1"	-16	1"	-16	91	142	44	44,5		210	3000
HX1620FL67	25	1"	-16	1 1/4"	-20	91	142	44	50,8		210	3000
HX2020FL67	31,5	1 1/4"	-20	1 1/4"	-20	109	167	51	50,8		125	1800
HX2024FL67	31,5	1 1/4"	-20	1 1/2"	-24	109	167	51	60,3		125	1800
HX2424FL67	38	1 1/2"	-24	1 1/2"	-24	129	194	59	60,3		90	1300
HX3232FL67	51	2"	-32	2"	-32	177	247	87	71,4		80	1160

FP
SAE CODE 62 FLANGE
 FLANGIA SAE CODE 62

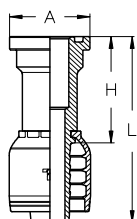
SFS

TIEFFE Part.N.	Hose Size			Flange Size Connection		Dimensions (mm)					Maximum W.P.	
	DN	Inch	Dash	Inch	Dash	H	L	A			bar	PSI
HX0808FP	12,5	1/2"	-08	1/2"	-08	47	80	31,8			280	4000
HX0812FP	12,5	1/2"	-08	3/4"	-12	47	80	41,3			280	4000
HX1008FP	16	5/8"	-10	1/2"	-08	48	84	31,8			280	4000
HX1012FP	16	5/8"	-10	3/4"	-12	48	84	41,3			280	4000
HX1208FP	19	3/4"	-12	1/2"	-08	50	90,5	31,8			280	4000
HX1212FP	19	3/4"	-12	3/4"	-12	58	98,5	41,3			280	4000
HX1216FP	19	3/4"	-12	1"	-16	58	98,5	47,6			280	4000
HX1612FP	25	1"	-16	3/4"	-12	60	115	41,3			210	3000
HX1616FP	25	1"	-16	1"	-16	64	115	47,6			210	3000
HX1620FP	25	1"	-16	1 1/4"	-20	64	115	54			210	3000
HX2016FP	31,5	1 1/4"	-20	1"	-16	67,5	125	47,6			125	1800
HX2020FP	31,5	1 1/4"	-20	1 1/4"	-20	67,5	125	54			125	1800
HX2024FP	31,5	1 1/4"	-20	1 1/2"	-24	67,5	125	63,5			125	1800
HX2424FP	38	1 1/2"	-24	1 1/2"	-24	79,5	144	63,5			90	1300
HX2432FP	38	1 1/2"	-24	2"	-32	79,5	144	79,4			90	1300
HX3232FP	51	2"	-32	2"	-32	95	165	79,4			80	1160

FP90
 LONG DROP

SAE CODE 62 FLANGE - 45° ELBOW
 FLANGIA SAE CODE 62 - CURVA A 45°

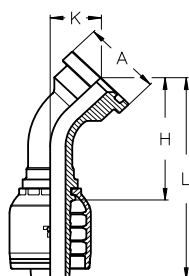
SFS45

TIEFFE Part.N.	Hose Size			Flange Size Connection		Dimensions (mm)					Maximum W.P.	
	DN	Inch	Dash	Inch	Dash	H	L	K	A		bar	PSI
HX0808FP45	12,5	1/2"	-08	1/2"	-08	47	80	20	31,8		280	4000
HX0812FP45	12,5	1/2"	-08	3/4"	-12	53	86	26	41,3		280	4000
HX1008FP45	16	5/8"	-10	1/2"	-08	51	87	21	31,8		280	4000
HX1012FP45	16	5/8"	-10	3/4"	-12	57	93	26	41,3		280	4000
HX1208FP45	19	3/4"	-12	1/2"	-08	64	104	26	31,8		280	4000
HX1212FP45	19	3/4"	-12	3/4"	-12	64	104	26	41,3		280	4000
HX1216FP45	19	3/4"	-12	1"	-16	68	108	31	47,6		280	4000
HX1612FP45	25	1"	-16	3/4"	-12	79	130	31	41,3		210	3000
HX1616FP45	25	1"	-16	1"	-16	80	131	32	47,6		210	3000
HX1620FP45	25	1"	-16	1 1/4"	-20	85	136	37	54		210	3000
HX2016FP45	31,5	1 1/4"	-20	1"	-16	94	152	37	47,6		125	1800
HX2020FP45	31,5	1 1/4"	-20	1 1/4"	-20	93	151	37	54		125	1800
HX2024FP45	31,5	1 1/4"	-20	1 1/2"	-24	99	157	43	63,5		125	1800
HX2424FP45	38	1 1/2"	-24	1 1/2"	-24	111	175	44	63,5		90	1300
HX2432FP45	38	1 1/2"	-24	2"	-32	122	186	55	79,4		90	1300
HX3232FP45	51	2"	-32	2"	-32	147	217	58	79,4		80	1160

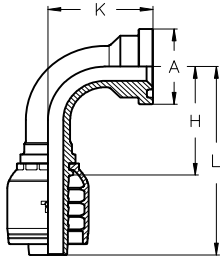
FP90
SAE CODE 62 FLANGE - 90° ELBOW
FLANGIA SAE CODE 62 - CURVA A 90°
SFS90

TIEFFE Part.N.	Hose Size			Flange Size Connection		Dimensions (mm)					Maximum W.P.	
	DN	Inch	Dash	Inch	Dash	H	L	K	A		bar	PSI
HX0808FP90	12,5	1/2"	-08	1/2"	-08	38	71	40	31,8		280	4000
HX0812FP90	12,5	1/2"	-08	3/4"	-12	38	71	47	41,3		280	4000
HX1008FP90	16	5/8"	-10	1/2"	-08	45	81	42	31,8		280	4000
HX1012FP90	16	5/8"	-10	3/4"	-12	45	81	50	41,3		280	4000
HX1208FP90	19	3/4"	-12	1/2"	-08	55	95	54	31,8		280	4000
HX1212FP90	19	3/4"	-12	3/4"	-12	55	95	54	41,3		280	4000
HX1216FP90	19	3/4"	-12	1"	-16	55	95	60	47,6		280	4000
HX1612FP90	25	1"	-16	3/4"	-12	70	121	65	41,3		210	3000
HX1616FP90	25	1"	-16	1"	-16	70	121	66	47,6		210	3000
HX1620FP90	25	1"	-16	1 1/4"	-20	70	121	73	54		210	3000
HX2016FP90	31,5	1 1/4"	-20	1"	-16	85	142	80	47,6		125	1800
HX2020FP90	31,5	1 1/4"	-20	1 1/4"	-20	85	142	78	54		125	1800
HX2024FP90	31,5	1 1/4"	-20	1 1/2"	-24	85	142	86	63,5		125	1800
HX2424FP90	38	1 1/2"	-24	1 1/2"	-24	105	170	93	63,5		90	1300
HX2432FP90	38	1 1/2"	-24	2"	-32	105	170	109	79,4		90	1300
HX3232FP90	51	2"	-32	2"	-32	140	210	125	79,4		80	1160

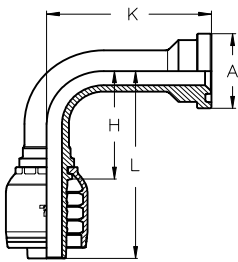
FP90
LONG DROP
SAE CODE 62 FLANGE - 90° ELBOW - LONG DROP
FLANGIA SAE CODE 62 - CURVA A 90° - LUNGA
SFS90
LONG DROP

TIEFFE Part.N.	Hose Size			Flange Size Connection		Dimensions (mm)					Maximum W.P.	
	DN	Inch	Dash	Inch	Dash	H	L	K	A		bar	PSI
HX1212FP90-K85	19	3/4"	-12	3/4"	-12	55	95	85	41,3		280	4000
HX1212FP90-K100	19	3/4"	-12	3/4"	-12	55	95	100	41,3		280	4000
HX1216FP90-K140	19	3/4"	-12	1"	-16	55	95	140	47,6		280	4000
HX1616FP90-K120	25	1"	-16	1"	-16	70	121	120	47,6		210	3000
HX2020FP90-K120	31,5	1 1/4"	-20	1 1/4"	-20	85	142	120	54		125	1800

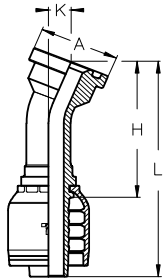
FP22
SAE CODE 62 FLANGE - 22,5° ELBOW
FLANGIA SAE CODE 62 - CURVA A 2,5°
SFS22,5

TIEFFE Part.N.	Hose Size			Flange Size Connection		Dimensions (mm)					Maximum W.P.	
	DN	Inch	Dash	Inch	Dash	H	L	K	A		bar	PSI
HX0808FP22	12,5	1/2"	-08	1/2"	-08	53	86	10	31,8		280	4000
HX0812FP22	12,5	1/2"	-08	3/4"	-12	60	93	13	41,3		280	4000
HX1212FP22	19	3/4"	-12	3/4"	-12	71	112	13	41,3		280	4000
HX1216FP22	19	3/4"	-12	1"	-16	77	117	15	47,6		280	4000
HX1616FP22	25	1"	-16	1"	-16	89	140	15	47,6		210	3000
HX1620FP22	25	1"	-16	1 1/4"	-20	95	146	17	54		210	3000
HX2020FP22	31,5	1 1/4"	-20	1 1/4"	-20	103	161	17	54		125	1800
HX2024FP22	31,5	1 1/4"	-20	1 1/2"	-24	112	169	20	63,5		125	1800
HX2424FP22	38	1 1/2"	-24	1 1/2"	-24	123	188	20	63,5		90	1300
HX3232FP22	51	2"	-32	2"	-32	163	233	25	79,4		80	1160

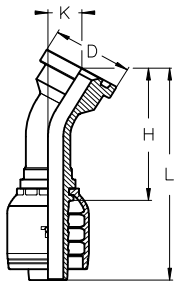
FP30
SAE CODE 62 FLANGE - 30° ELBOW
FLANGIA SAE CODE 62 - CURVA A 30°
SFS30

TIEFFE Part.N.	Hose Size			Flange Size Connection		Dimensions (mm)					Maximum W.P.	
	DN	Inch	Dash	Inch	Dash	H	L	K	A		bar	PSI
HX0808FP30	12,5	1/2"	-08	1/2"	-08	51	84	13	31,8		280	4000
HX0812FP30	12,5	1/2"	-08	3/4"	-12	58	91	17	41,3		280	4000
HX1212FP30	19	3/4"	-12	3/4"	-12	69	110	17	41,3		280	4000
HX1216FP30	19	3/4"	-12	1"	-16	75	115	20	47,6		280	4000
HX1616FP30	25	1"	-16	1"	-16	87	138	20	47,6		210	3000
HX1620FP30	25	1"	-16	1 1/4"	-20	93	144	23	54		210	3000
HX2020FP30	31,5	1 1/4"	-20	1 1/4"	-20	101	159	23	54		125	1800
HX2024FP30	31,5	1 1/4"	-20	1 1/2"	-24	109	166	28	63,5		125	1800
HX2424FP30	38	1 1/2"	-24	1 1/2"	-24	121	185	28	63,5		90	1300
HX3232FP30	51	2"	-32	2"	-32	160	230	35	79,4		80	1160

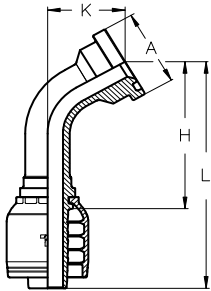
FP60
SAE CODE 62 FLANGE - 60° ELBOW
FLANGIA SAE CODE 62 - CURVA A 60°
SFS60

TIEFFE Part.N.	Hose Size			Flange Size Connection		Dimensions (mm)					Maximum W.P.	
	DN	Inch	Dash	Inch	Dash	H	L	K	A		bar	PSI
HX0808FP60	12,5	1/2"	-08	1/2"	-08	55	88	27	31,8		280	4000
HX0812FP60	12,5	1/2"	-08	3/4"	-12	59	92	34	41,3		280	4000
HX1212FP60	19	3/4"	-12	3/4"	-12	78	118	36	41,3		280	4000
HX1216FP60	19	3/4"	-12	1"	-16	81	121	41	47,6		280	4000
HX1616FP60	25	1"	-16	1"	-16	99	150	43	47,6		210	3000
HX1620FP60	25	1"	-16	1 1/4"	-20	103	154	49	54		210	3000
HX2020FP60	31,5	1 1/4"	-20	1 1/4"	-20	119	177	51	54		125	1800
HX2024FP60	31,5	1 1/4"	-20	1 1/2"	-24	123	181	58	63,5		125	1800
HX2424FP60	38	1 1/2"	-24	1 1/2"	-24	142	206	60	63,5		90	1300
HX3232FP60	51	2"	-32	2"	-32	190	260	80	79,4		80	1160

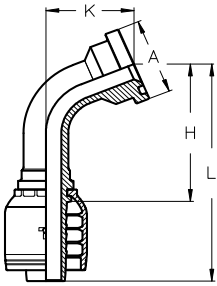
FP67
SAE CODE 62 FLANGE - 67,5° ELBOW
FLANGIA SAE CODE 62 - CURVA A 67,5°
SFS67,5

TIEFFE Part.N.	Hose Size			Flange Size Connection		Dimensions (mm)					Maximum W.P.	
	DN	Inch	Dash	Inch	Dash	H	L	K	A		bar	PSI
HX0808FP67	12,5	1/2"	-08	1/2"	-08	51	84	31	31,8		280	4000
HX0812FP67	12,5	1/2"	-08	3/4"	-12	54	87	38	41,3		280	4000
HX1212FP67	19	3/4"	-12	3/4"	-12	73	113	41	41,3		280	4000
HX1216FP67	19	3/4"	-12	1"	-16	75	116	46	47,6		280	4000
HX1616FP67	25	1"	-16	1"	-16	93	144	49	47,6		210	3000
HX1620FP67	25	1"	-16	1 1/4"	-20	96	147	56	54		210	3000
HX2020FP67	31,5	1 1/4"	-20	1 1/4"	-20	112	170	58	54		125	1800
HX2024FP67	31,5	1 1/4"	-20	1 1/2"	-24	115	173	66	63,5		125	1800
HX2424FP67	38	1 1/2"	-24	1 1/2"	-24	134	198	69	63,5		90	1300
HX3232FP67	51	2"	-32	2"	-32	179	249	92	79,4		80	1160

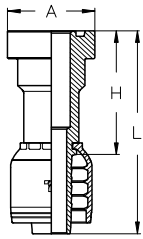
YP

"SUPERCAT" FLANGE
FLANGIA "SUPERCAT"

SFS
SUPERCAT

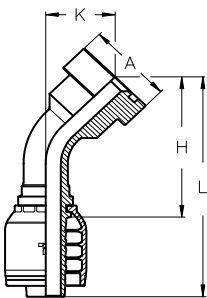
TIEFFE Part.N.	Hose Size			Flange Size Connection		Dimensions (mm)					Maximum W.P.	
	DN	Inch	Dash	Inch	Dash	H	L	A			bar	PSI
HX1212YP	19	3/4"	-12	3/4"	-12	66	106,5	41,3			280	4000
HX1216YP	19	3/4"	-12	1"	-16	68	108,5	47,6			280	4000
HX1616YP	25	1"	-16	1"	-16	72	123	47,6			210	3000
HX1620YP	25	1"	-16	1 1/4"	-20	75	126	54			210	3000
HX2020YP	31,5	1 1/4"	-20	1 1/4"	-20	75	133	54			125	1800
HX2024YP	31,5	1 1/4"	-20	1 1/2"	-24	82	140	63,5			125	1800
HX2424YP	38	1 1/2"	-24	1 1/2"	-24	83	147,5	63,5			90	1300

YP45

"SUPERCAT" FLANGE - 45° ELBOW
FLANGIA "SUPERCAT" - CURVA A45°

SFS45
SUPERCAT

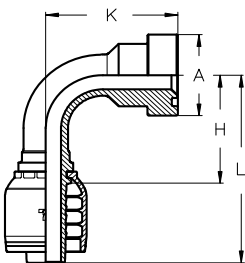
TIEFFE Part.N.	Hose Size			Flange Size Connection		Dimensions (mm)					Maximum W.P.	
	DN	Inch	Dash	Inch	Dash	H	L	K	A		bar	PSI
HX1212YP45	19	3/4"	-12	3/4"	-12	71	112	34	41,3		280	4000
HX1216YP45	19	3/4"	-12	1"	-16	74	114	36	47,6		280	4000
HX1616YP45	25	1"	-16	1"	-16	86	137	37	47,6		210	3000
HX1620YP45	25	1"	-16	1 1/4"	-20	88	139	38	54		210	3000
HX2020YP45	31,5	1 1/4"	-20	1 1/4"	-20	86	154	39	54		125	1800
HX2024YP45	31,5	1 1/4"	-20	1 1/2"	-24	102	160	45	63,5		125	1800
HX2424YP45	38	1 1/2"	-24	1 1/2"	-24	114	179	45	63,5		90	1300

YP90

"SUPERCAT" FLANGE - 90° ELBOW
FLANGIA "SUPERCAT" - CURVA A90°

SFS90
SUPERCAT

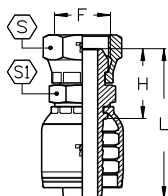
TIEFFE Part.N.	Hose Size			Flange Size Connection		Dimensions (mm)					Maximum W.P.	
	DN	Inch	Dash	Inch	Dash	H	L	K	A		bar	PSI
HX1212YP90	19	3/4"	-12	3/4"	-12	55	95	64	41,3		280	4000
HX1216YP90	19	3/4"	-12	1"	-16	55	95	67	47,6		280	4000
HX1616YP90	25	1"	-16	1"	-16	71	122	73	47,6		210	3000
HX1620YP90	25	1"	-16	1 1/4"	-20	71	122	75	54		210	3000
HX2020YP90	31,5	1 1/4"	-20	1 1/4"	-20	86	143	80	54		125	1800
HX2024YP90	31,5	1 1/4"	-20	1 1/2"	-24	86	143	89	63,5		125	1800
HX2424YP90	38	1 1/2"	-24	1 1/2"	-24	102	167	95	63,5		90	1300

FGCP
"NISSAN" BSP FEMALE 60° CONE - DOUBLE EXAGON - CRIMPED-BACK NUT
FEMMINA GAS "NISSAN" OGIVA 60° - DOPPIO ESAGONO - DADO PRESSATO
DKR

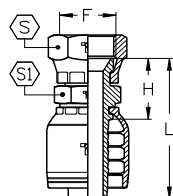
TIEFFE Part.N.	Hose Size			BSP Connection size		Dimensions (mm)					Maximum W.P.		
	DN	Inch	Dash	F	Dash	H	L	S	S1		bar	PSI	
HX0304FGCP	5	3/16"	-03	1/4"-19	-04	23	48	19	14			415	6000
HX0404FGCP	6,3	1/4"	-04	1/4"-19	-04	24	52	19	14			400	5800
HX0406FGCP	6,3	1/4"	-04	3/8"-19	-06	26	54	22	17			400	5800
HX0506FGCP	8	5/16"	-05	3/8"-19	-06	26	54	22	17			350	5000
HX0606FGCP	10	3/8"	-06	3/8"-19	-06	26	57	22	17			330	4800
HX0608FGCP	10	3/8"	-06	1/2"-14	-08	29	60	27	22			330	4800
HX0808FGCP	12,5	1/2"	-08	1/2"-14	-08	30	63	27	22			280	4000
HX1012FGCP	16	5/8"	-10	3/4"-14	-12	35	71	32	27			280	4000
HX1212FGCP	19	3/4"	-12	3/4"-14	-12	36	76	32	27			280	4000
HX1616FGCP	25	1"	-16	1"-11	-16	40	91	41	32			210	3000
HX2020FGCP	31,5	1 1/4"	-20	1 1/4"-11	-20	46	104	50	41			125	1800
HX2424FGCP	38	1 1/2"	-24	1 1/2"-11	-24	47	112	55	46			90	1300
HX3232FGCP	51	2"	-32	2"-11	-32	53	123	70	60			80	1160

FTC
"TOYOTA" BSP FEMALE 60° CONE SEAT - DOUBLE EXAGON - CRIMPED BACK NUT
FEMMINA GAS "TOYOTA" SVASATA 60° - DOPPIO ESAGONO - DADO PRESSATO

TIEFFE Part.N.	Hose Size			BSP Connection size		Dimensions (mm)					Maximum W.P.		
	DN	Inch	Dash	F	Dash	H	L	S	S1		bar	PSI	
HX0404FTC	6,3	1/4"	-04	1/4"-19	-04	21,5	49,5	19	17			350	5000
HX0606FTC	10	3/8"	-06	3/8"-19	-06	22,5	53	22	19			350	5000
HX0808FTC	12,5	1/2"	-08	1/2"-14	-08	26	59	27	22			350	5000
HX1212FTC	19	3/4"	-12	3/4"-14	-12	31	71,5	32	27			280	4000
HX1616FTC	25	1"	-16	1"-11	-16	36	87	41	36			210	3000
HX2020FTC	31,5	1 1/4"	-20	1 1/4"-11	-20	40,5	98	50	46			175	2500
HX2424FTC	38	1 1/2"	-24	1 1/2"-11	-24	42,5	107	55	50			105	1500

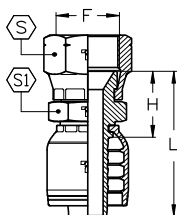
FMG
"KOMATSU" METRIC FEMALE 60° CONE SEAT - DOUBLE EXAGON - CRIMPED BACK NUT
FEMMINA METRICA "KOMATSU" SVASATA 60° - DOPPIO ESAGONO - DADO PRESSATO

TIEFFE Part.N.	Hose Size			METRIC Connection	Dimensions (mm)					Maximum W.P.		
	DN	Inch	Dash	F	H	L	S	S1		bar	PSI	
HX04FMG14A	6,3	1/4"	-04	M14x1,5	21,5	49,5	19	17			350	5000
HX05FMG16A	8	5/16"	-05	M16x1,5	22	50	22	17			350	5000
HX06FMG14A	10	3/8"	-06	M14x1,5	21,5	52	19	17			350	5000
HX06FMG16A	10	3/8"	-06	M16x1,5	22	52,5	22	17			350	5000
HX06FMG18A	10	3/8"	-06	M18x1,5	22,5	53	24	19			350	5000
HX08FMG22A	12,5	1/2"	-08	M22x1,5	26	59	27	22			350	5000
HX08FMG24A	12,5	1/2"	-08	M24x1,5	30	63	32	27			350	5000
HX10FMG24A	16	5/8"	-10	M24x1,5	60	66	32	27			280	4000
HX12FMG30A	19	3/4"	-12	M30x1,5	33,5	74	36	32			280	4000
HX16FMG33A	25	1"	-16	M33x1,5	36	87	41	36			210	3000
HX20FMG36A	31,5	1 1/4"	-20	M36x1,5	40	97,5	46	41			175	2500
HX24FMG42A	38	1 1/2"	-24	M42x1,5	42,5	107	50	46			105	1500

MW
METRIC MALE 60° CONE SEAT
 MASCHIO METRICO SVASATO 60°

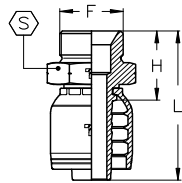
AGM

TIEFFE Part.N.	Hose Size			METRIC 60° Connection	Dimensions (mm)					Maximum W.P.	
	DN	Inch	Dash	F	H	L	S			bar	PSI
HX03MW10C	5	3/16"	-03	M10x1	18,5	43,5	14			280	4000
HX03MW12A	5	3/16"	-03	M12x1,5	23,5	48,5	17			280	4000
HX04MW10C	6,3	1/4"	-04	M10x1	19	47	14			280	4000
HX04MW12A	6,3	1/4"	-04	M12x1,5	24	52	17			280	4000
HX04MW14A	6,3	1/4"	-04	M14x1,5	24	52	19			280	4000
HX04MW16A	6,3	1/4"	-04	M16x1,5	25	53	22			280	4000
HX04MW18A	6,3	1/4"	-04	M18x1,5	26	54	24			280	4000
HX05MW14A	8	5/16"	-05	M14x1,5	24	52	19			280	4000
HX05MW16A	8	5/16"	-05	M16x1,5	25	53	22			280	4000
HX05MW18A	8	5/16"	-05	M18x1,5	26	54	24			280	4000
HX06MW14A	10	3/8"	-06	M14x1,5	24	54,5	19			280	4000
HX06MW16A	10	3/8"	-06	M16x1,5	25	55,5	22			280	4000
HX06MW18A	10	3/8"	-06	M18x1,5	26	56,5	24			280	4000
HX06MW20A	10	3/8"	-06	M20x1,5	29	59,5	27			280	4000
HX06MW22A	10	3/8"	-06	M22x1,5	29	59,5	27			280	4000
HX08MW18A	12,5	1/2"	-08	M18x1,5	27	60	24			280	4000
HX08MW20A	12,5	1/2"	-08	M20x1,5	30	63	27			280	4000
HX08MW22A	12,5	1/2"	-08	M22x1,5	30	63	27			280	4000
HX08MW24A	12,5	1/2"	-08	M24x1,5	30	63	30			280	4000
HX08MW26A	12,5	1/2"	-08	M26x1,5	33	66	32			280	4000
HX10MW22A	16	5/8"	-10	M22x1,5	30	66	27			280	4000
HX10MW24A	16	5/8"	-10	M24x1,5	30	66	30			280	4000
HX10MW26A	16	5/8"	-10	M26x1,5	33	69	32			280	4000
HX10MW27A	16	5/8"	-10	M27x1,5	33	69	32			280	4000
HX12MW26A	19	3/4"	-12	M26x1,5	34	74,5	32			280	4000
HX12MW27A	19	3/4"	-12	M27x1,5	34	74,5	32			280	4000
HX12MW30A	19	3/4"	-12	M30x1,5	35	75,5	36			210	1500
HX16MW38A	25	1"	-16	M38x1,5	38,5	89,5	46			165	2400
HX20MW45A	31,5	1 1/4"	-20	M45x1,5	41,5	99	55			125	1800
HX24MW52A	38	1 1/2"	-24	M52x1,5	42,5	107	60			90	1300

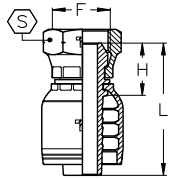
FW
METRIC FEMALE 60° CONE - CRIMPED-BACK NUT
FEMMINA METRICA OGIVA 60° - DADO PRESSATO
DKM

TIEFFE Part.N.	Hose Size			METRIC 60° Connection F	Dimensions (mm)					Maximum W.P.		
	DN	Inch	Dash		H	L	S			bar	PSI	
HX03FW10C	5	3/16"	-03	M10x1	16	41	14				280	4000
HX03FW12A	5	3/16"	-03	M12x1,5	16	41	15				280	4000
HX04FW10C	6,3	1/4"	-04	M10x1	17	45	17				280	4000
HX04FW12A	6,3	1/4"	-04	M12x1,5	16,5	44,5	15				280	4000
HX04FW14A	6,3	1/4"	-04	M14x1,5	18,5	46,5	17				280	4000
HX04FW16A	6,3	1/4"	-04	M16x1,5	18,5	46,5	19				280	4000
HX04FW18A	6,3	1/4"	-04	M18x1,5	21,5	49,5	22				280	4000
HX05FW14A	8	5/16"	-05	M14x1,5	19	47	17				280	4000
HX05FW16A	8	5/16"	-05	M16x1,5	18	46	19				280	4000
HX05FW18A	8	5/16"	-05	M18x1,5	21,5	49,5	22				280	4000
HX06FW14A	10	3/8"	-06	M14x1,5	19,5	50	17				280	4000
HX06FW16A	10	3/8"	-06	M16x1,5	18,5	49	19				280	4000
HX06FW18A	10	3/8"	-06	M18x1,5	20,5	51	22				280	4000
HX06FW20A	10	3/8"	-06	M20x1,5	20,5	51	24				280	4000
HX06FW22A	10	3/8"	-06	M22x1,5	23	53,5	27				280	4000
HX08FW18A	12,5	1/2"	-08	M18x1,5	22,5	55,5	22				280	4000
HX08FW20A	12,5	1/2"	-08	M20x1,5	21,5	54,5	24				280	4000
HX08FW22A	12,5	1/2"	-08	M22x1,5	23	56	27				280	4000
HX08FW24A	12,5	1/2"	-08	M24x1,5	23,5	56,5	30				280	4000
HX08FW26A	12,5	1/2"	-08	M26x1,5	27	60	32				280	4000
HX10FW22A	16	5/8"	-10	M22x1,5	24	60	27				280	4000
HX10FW24A	16	5/8"	-10	M24x1,5	22,5	58,5	30				280	4000
HX10FW26A	16	5/8"	-10	M26x1,5	27	63	32				280	4000
HX10FW27A	16	5/8"	-10	M27x1,5	22	63	32				280	4000
HX12FW26A	19	3/4"	-12	M26x1,5	26,5	67	32				280	4000
HX12FW27A	19	3/4"	-12	M27x1,5	26,5	67	32				280	4000
HX12FW30A	19	3/4"	-12	M30x1,5	27	67,5	36				210	1500
HX16FW38A	25	1"	-16	M38x1,5	31	82	46				165	2400
HX20FW45A	31,5	1 1/4"	-20	M45x1,5	32	89,5	50				125	1800
HX24FW52A	38	1 1/2"	-24	M52x1,5	33,5	98	60				90	1300

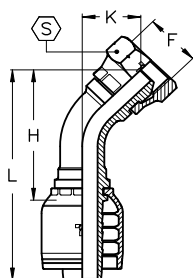
FW45
METRIC FEMALE 60° CONE - 45° ELBOW - CRIMPED BACK NUT
FEMMINA METRICA OGIVA 60° - CURVA A 45° - DADO PRESSATO
DKM45

TIEFFE Part.N.	Hose Size			METRIC 60° Connection	Dimensions (mm)					Maximum W.P.	
	DN	Inch	Dash		F	H	L	K	S	bar	PSI
HX03FW10C45	5	3/16"	-03	M10x1	33	58	14	14		280	4000
HX03FW12A45	5	3/16"	-03	M12x1,5	33,5	58,5	14,5	15		280	4000
HX04FW10C45	6,3	1/4"	-04	M10x1	36	64	15,5	17		280	4000
HX04FW12A45	6,3	1/4"	-04	M12x1,5	35	63	14,5	15		280	4000
HX04FW14A45	6,3	1/4"	-04	M14x1,5	37	65	16	17		280	4000
HX04FW16A45	6,3	1/4"	-04	M16x1,5	37	65	16	19		280	4000
HX04FW18A45	6,3	1/4"	-04	M18x1,5	40	68	19	22		280	4000
HX05FW14A45	8	5/16"	-05	M14x1,5	39	67	18	17		280	4000
HX05FW16A45	8	5/16"	-05	M16x1,5	38	66	16	19		280	4000
HX05FW18A45	8	5/16"	-05	M18x1,5	41	69	19	22		280	4000
HX06FW14A45	10	3/8"	-06	M14x1,5	41	72	18	17		280	4000
HX06FW16A45	10	3/8"	-06	M16x1,5	39	70	16	19		280	4000
HX06FW18A45	10	3/8"	-06	M18x1,5	42	73	19	22		280	4000
HX06FW20A45	10	3/8"	-06	M20x1,5	42	73	18	24		280	4000
HX06FW22A45	10	3/8"	-06	M22x1,5	44	75	21	27		280	4000
HX08FW18A45	12,5	1/2"	-08	M18x1,5	49	82	22	22		280	4000
HX08FW20A45	12,5	1/2"	-08	M20x1,5	47	80	20	24		280	4000
HX08FW22A45	12,5	1/2"	-08	M22x1,5	49	82	22	27		280	4000
HX08FW24A45	12,5	1/2"	-08	M24x1,5	49	82	22	30		280	4000
HX08FW26A45	12,5	1/2"	-08	M26x1,5	53	86	26	32		280	4000
HX10FW22A45	16	5/8"	-10	M22x1,5	57	93	26	27		280	4000
HX10FW24A45	16	5/8"	-10	M24x1,5	54	90	24	30		280	4000
HX10FW26A45	16	5/8"	-10	M26x1,5	57	93	26	32		280	4000
HX10FW27A45	16	5/8"	-10	M27x1,5	57	93	26	32		280	4000
HX12FW26A45	19	3/4"	-12	M26x1,5	66	106	28	32		280	4000
HX12FW27A45	19	3/4"	-12	M27x1,5	66	106	28	32		280	4000
HX12FW30A45	19	3/4"	-12	M30x1,5	66	107	29	36		210	1500
HX16FW38A45	25	1"	-16	M38x1,5	84	135	35	46		165	2400
HX20FW45A45	31,5	1 1/4"	-20	M45x1,5	97	155	40	50		125	1800
HX24FW52A45	38	1 1/2"	-24	M52x1,5	114	179	46	60		90	1300

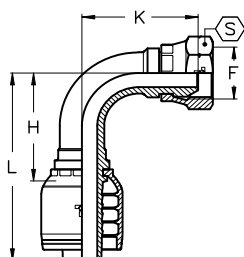
FW90
METRIC FEMALE 60° CONE - 90° ELBOW - CRIMPED BACK NUT
FEMMINA METRICA OGIVA 60° - CURVA A 90° - DADO PRESSATO
DKM90

TIEFFE Part.N.	Hose Size			METRIC 60° Connection F	Dimensions (mm)					Maximum W.P.	
	DN	Inch	Dash		H	L	K	S	bar	PSI	
HX03FW10C90	5	3/16"	-03	M10x1	21	46	23	14		280	4000
HX03FW12A90	5	3/16"	-03	M12x1,5	21	46	24	15		280	4000
HX04FW10C90	6,3	1/4"	-04	M10x1	26	54	28	17		280	4000
HX04FW12A90	6,3	1/4"	-04	M12x1,5	26	54	26	15		280	4000
HX04FW14A90	6,3	1/4"	-04	M14x1,5	26	54	28	17		280	4000
HX04FW16A90	6,3	1/4"	-04	M16x1,5	26	54	29	19		280	4000
HX04FW18A90	6,3	1/4"	-04	M18x1,5	26	54	32	22		280	4000
HX05FW14A90	8	5/16"	-05	M14x1,5	28	56	31	17		280	4000
HX05FW16A90	8	5/16"	-05	M16x1,5	28	56	30	19		280	4000
HX05FW18A90	8	5/16"	-05	M18x1,5	28	56	34	22		280	4000
HX06FW14A90	10	3/8"	-06	M14x1,5	31	61	34	17		280	4000
HX06FW16A90	10	3/8"	-06	M16x1,5	31	61	31	19		280	4000
HX06FW18A90	10	3/8"	-06	M18x1,5	31	61	35	22		280	4000
HX06FW20A90	10	3/8"	-06	M20x1,5	31	61	36	24		280	4000
HX06FW22A90	10	3/8"	-06	M22x1,5	31	61	38	27		280	4000
HX08FW18A90	12,5	1/2"	-08	M18x1,5	37	70	42	22		280	4000
HX08FW20A90	12,5	1/2"	-08	M20x1,5	37	70	40	24		280	4000
HX08FW22A90	12,5	1/2"	-08	M22x1,5	37	70	42	27		280	4000
HX08FW24A90	12,5	1/2"	-08	M24x1,5	37	70	43	30		280	4000
HX08FW26A90	12,5	1/2"	-08	M26x1,5	37	70	48	32		280	4000
HX10FW22A90	16	5/8"	-10	M22x1,5	45	80	50	27		280	4000
HX10FW24A90	16	5/8"	-10	M24x1,5	45	80	46	30		280	4000
HX10FW26A90	16	5/8"	-10	M26x1,5	45	80	50	32		280	4000
HX10FW27A90	16	5/8"	-10	M27x1,5	45	80	50	32		280	4000
HX12FW26A90	19	3/4"	-12	M26x1,5	54	95	56	32		280	4000
HX12FW27A90	19	3/4"	-12	M27x1,5	54	95	56	32		280	4000
HX12FW30A90	19	3/4"	-12	M30x1,5	54	95	57	36		210	1500
HX16FW38A90	25	1"	-16	M38x1,5	70	121	71	46		165	2400
HX20FW45A90	31,5	1 1/4"	-20	M45x1,5	84	142	83	50		125	1800
HX24FW52A90	38	1 1/2"	-24	M52x1,5	100	165	96	60		90	1300

OM
METRIC BANJO
OCCHIO METRICO

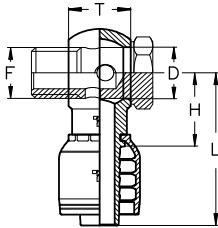
RNM

TIEFFE Part.N.	Hose Size			Metric BOLT Thread	Dimensions (mm)							
	DN	Inch	Dash	F	H	L	D	T				
HX0302OG	5	3/16"	-03	M10x1	20	45	10,2	10			200	2900
HX0312OM	5	3/16"	-03	M12x1,5	21,1	46,1	12,1	12			200	2900
HX0314OM	5	3/16"	-03	M14x1,5	22,6	47,6	14,2	14			200	2900
HX0402OG	6,3	1/4"	-04	M10x1	23	51	10,2	10			200	2900
HX0412OM	6,3	1/4"	-04	M12x1,5	23	51	12,1	12			200	2900
HX0414OM	6,3	1/4"	-04	M14x1,5	23	51	14,2	14			200	2900
HX0416OM	6,3	1/4"	-04	M16x1,5	26,5	54,5	16,2	17,5			200	2900
HX0418OM	6,3	1/4"	-04	M18x1,5	28,5	56,5	18,2	20,5			200	2900
HX0512OM	8	5/16"	-05	M12x1,5	23,5	51,5	12,1	12			200	2900
HX0514OM	8	5/16"	-05	M14x1,5	24	52	14,2	14			200	2900
HX0516OM	8	5/16"	-05	M16x1,5	26,5	54,5	16,2	17,5			200	2900
HX0518OM	8	5/16"	-05	M18x1,5	28,5	56,5	18,2	20,5			200	2900
HX0614OM	10	3/8"	-06	M14x1,5	24	54,5	14,2	14			200	2900
HX0616OM	10	3/8"	-06	M16x1,5	24	54,5	16,2	17,5			200	2900
HX0618OM	10	3/8"	-06	M18x1,5	27	57,5	18,2	20,5			200	2900
HX0620OM	10	3/8"	-06	M20x1,5	32	62,5	20,2	23			200	2900
HX0622OM	10	3/8"	-06	M22x1,5	32	62,5	22,2	22,5			200	2900
HX0812OG	12,5	1/2"	-08	M26x1,5	39	72	26,5	29,5			200	2900
HX0818OM	12,5	1/2"	-08	M18x1,5	28,1	61,1	18,2	20,5			200	2900
HX0820OM	12,5	1/2"	-08	M20x1,5	28,5	61,5	20,2	23			200	2900
HX0822OM	12,5	1/2"	-08	M22x1,5	28,5	61,5	22,2	22,5			200	2900
HX1012OG	16	5/8"	-10	M26x1,5	34,7	70,5	26,5	29,5			200	2900
HX1022OM	16	5/8"	-10	M22x1,5	27,2	63	22,2	22,5			200	2900
HX1212OG	19	3/4"	-12	M26x1,5	37,5	78	26,5	29,5			200	2900
HX1230OM	19	3/4"	-16	M30x1,5	41,5	82	30,2	36			200	2900
HX1630OM	25	1"	-20	M30x1,5	43	94	30,2	36			200	2900

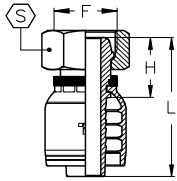
FM
METRIC FEMALE MULTISEAL - SLIP-ON NUT
FEMMINA METRICA MULTISEAL - DADO LIBERO
DKL

TIEFFE Part.N.	Hose Size			METRIC Connection		Dimensions (mm)					Maximum W.P.	
	DN	Inch	Dash	F	Pipe	H	L	S			bar	PSI
HX04FM8L	6,3	1/4"	-04	M14x1,5	8L	20	48	17			280	4000
HX05FM10L	8	5/16"	-05	M16x1,5	10L	20	48	19			280	4000
HX06FM12L	10	3/8"	-06	M18x1,5	12L	20	50	22			280	4000
HX08FM15L	12,5	1/2"	-08	M22x1,5	15L	21	54	27			280	4000
HX10FM18L	16	5/8"	-10	M26x1,5	18L	23	58	32			210	3000

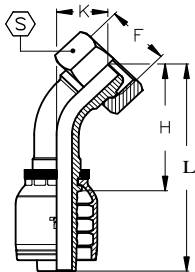
FM45
METRIC FEMALE MULTISEAL - 45° ELBOW - SLIP-ON NUT
FEMMINA METRICA MULTISEAL - CURVA A 45° - DADO LIBERO
DKL45

TIEFFE Part.N.	Hose Size			METRIC Connection		Dimensions (mm)					Maximum W.P.	
	DN	Inch	Dash	F	Pipe	H	L	K	S		bar	PSI
HX04FM8L45	6,3	1/4"	-04	M14x1,5	8L	35	63	13	17		280	4000
HX05FM10L45	8	5/16"	-05	M16x1,5	10L	37	65	15	19		280	4000
HX06FM12L45	10	3/8"	-06	M18x1,5	12L	39	69	15	22		280	4000
HX08FM15L45	12,5	1/2"	-08	M22x1,5	15L	45	78	17	27		280	4000
HX10FM18L45	16	5/8"	-10	M26x1,5	18L	52	87	20	32		210	3000

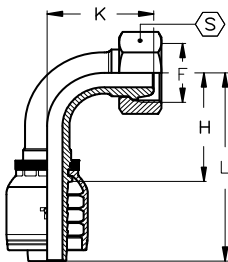
FM90
METRIC FEMALE MULTISEAL - 90° ELBOW - SLIP-ON NUT
FEMMINA METRICA MULTISEAL - CURVA A 90° - DADO LIBERO
DKL90

TIEFFE Part.N.	Hose Size			METRIC Connection		Dimensions (mm)					Maximum W.P.	
	DN	Inch	Dash	F	Pipe	H	L	K	S		bar	PSI
HX04FM8L90	6,3	1/4"	-04	M14x1,5	8L	29	57	27	17		280	4000
HX05FM10L90	8	5/16"	-05	M16x1,5	10L	31	59	30	19		280	4000
HX06FM12L90	10	3/8"	-06	M18x1,5	12L	31	61	30	22		280	4000
HX08FM15L90	12,5	1/2"	-08	M22x1,5	15L	37	70	36	27		280	4000
HX10FM18L90	16	5/8"	-10	M26x1,5	18L	45	81	42	32		210	3000

MM-L
METRIC MALE 24° CONE SEAT - LIGHT DUTY
 MASCHIO METRICO SVASATO 24° - SERIE LEGGERA

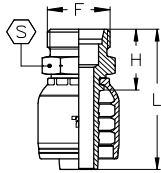
CEL

TIEFFE Part.N.	Hose Size			METRIC 24° Connection		Dimensions (mm)					Maximum W.P.	
	DN	Inch	Dash	F	Pipe	H	L	S			bar	PSI
HX03MM6L	5	3/16"	-03	M12x1,5	6L	21	46	12			280	4000
HX03MM8L	5	3/16"	-03	M14x1,5	8L	21	46	14			280	4000
HX04MM6L	6,3	1/4"	-04	M12x1,5	6L	21	49	12			280	4000
HX04MM8L	6,3	1/4"	-04	M14x1,5	8L	21	49	14			280	4000
HX04MM10L	6,3	1/4"	-04	M16x1,5	10L	23	51	17			280	4000
HX04MM12L	6,3	1/4"	-04	M18x1,5	12L	23	51	19			280	4000
HX05MM10L	8	5/16"	-05	M16x1,5	10L	23	51	17			280	4000
HX05MM12L	8	5/16"	-05	M18x1,5	12L	23	51	19			280	4000
HX06MM10L	10	3/8"	-06	M16x1,5	10L	23	53	17			280	4000
HX06MM12L	10	3/8"	-06	M18x1,5	12L	23	53	19			280	4000
HX06MM15L	10	3/8"	-06	M22x1,5	15L	25	56	22			280	4000
HX08MM15L	12,5	1/2"	-08	M22x1,5	15L	26	59	22			280	4000
HX08MM18L	12,5	1/2"	-08	M26x1,5	18L	28	61	27			210	3000
HX10MM18L	16	5/8"	-10	M26x1,5	18L	28	64	27			210	3000
HX10MM22L	16	5/8"	-10	M30x2	22L	30	66	30			210	3000
HX12MM18L	19	3/4"	-12	M26x1,5	18L	29	70	27			210	3000
HX12MM22L	19	3/4"	-12	M30x2	22L	31	72	30			210	3000
HX16MM28L	25	1"	-16	M36x2	28L	35	86	36			165	2400
HX20MM35L	31,5	1 1/4"	-20	M45x2	35L	40	97	46			100	1450
HX24MM42L	38	1 1/2"	-24	M52x2	42L	42	106	55			100	1450

MM-S
METRIC MALE - 24° CONE SEAT - HEAVY DUTY
 MASCHIO METRICO - SVASATO 24° - SERIE PESANTE

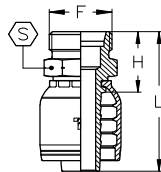
CES

TIEFFE Part.N.	Hose Size			METRIC 24° Connection		Dimensions (mm)					Maximum W.P.	
	DN	Inch	Dash	F	Pipe	H	L	S			bar	PSI
HX03MM6S	5	3/16"	-03	M14x1,5	6S	23	48	14			415	6000
HX03MM8S	5	3/16"	-03	M16x1,5	8S	23	48	17			415	6000
HX04MM6S	6,3	1/4"	-04	M14x1,5	6S	23	51	14			400	5800
HX04MM8S	6,3	1/4"	-04	M16x1,5	8S	23	51	17			400	5800
HX04MM10S	6,3	1/4"	-04	M18x1,5	10S	24	52	19			400	5800
HX04MM12S	6,3	1/4"	-04	M20x1,5	12S	25	53	22			400	5800
HX05MM10S	8	5/16"	-05	M18x1,5	10S	24	52	19			350	5000
HX05MM12S	8	5/16"	-05	M20x1,5	12S	25	53	22			350	5000
HX06MM10S	10	3/8"	-06	M18x1,5	10S	24	55	19			330	5000
HX06MM12S	10	3/8"	-06	M20x1,5	12S	25	56	22			330	4800
HX06MM14S	10	3/8"	-06	M22x1,5	14S	27	58	22			330	4800
HX08MM14S	12,5	1/2"	-08	M22x1,5	14S	28	61	22			280	4000
HX08MM16S	12,5	1/2"	-08	M24x1,5	16S	29	62	24			280	4000
HX10MM20S	16	5/8"	-10	M30x2	20S	32	68	30			280	4000
HX12MM20S	19	3/4"	-12	M30x2	20S	33	74	30			280	4000
HX12MM25S	19	3/4"	-12	M36x2	25S	37	78	36			280	4000
HX16MM25S	25	1"	-16	M36x2	25S	39	90	36			210	3000
HX16MM30S	25	1"	-16	M42x2	30S	43	94	46			210	3000
HX20MM30S	31,5	1 1/4"	-20	M42x2	30S	44	101	46			125	1800
HX20MM38S	31,5	1 1/4"	-20	M52x2	38S	48	105	55			125	1800
HX24MM38S	38	1 1/2"	-24	M52x2	38S	48	112	55			100	1450

FOS-L
METRIC FEMALE 24° O-RING CONE - LIGHT DUTY - SLIP-ON NUT
 FEMMINA METRICA OGIVA 24° O-RING - SERIE LEGGERA - DADO LIBERO

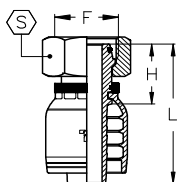
DKOL

TIEFFE Part.N.	Hose Size			METRIC 24° Connection		Dimensions (mm)					Maximum W.P.	
	DN	Inch	Dash	F	Pipe	H	L	S	O-RING	bar	PSI	
HX03FOS6L	5	3/16"	-03	M12x1,5	6L	21	46	14	5x1	280	4000	
HX03FOS8L	5	3/16"	-03	M14x1,5	8L	21	46	17	6x1,5	280	4000	
HX04FOS6L*	6,3	1/4"	-04	M12x1,5	6L	23	51	17	5x1	280	4000	
HX04FOS8L	6,3	1/4"	-04	M14x1,5	8L	22	50	17	6x1,5	280	4000	
HX04FOS10L	6,3	1/4"	-04	M16x1,5	10L	24	52	19	7,5x1,5	280	4000	
HX04FOS12L	6,3	1/4"	-04	M18x1,5	12L	24	52	22	9x1,5	280	4000	
HX05FOS10L	8	5/16"	-05	M16x1,5	10L	24	52	19	7,5x1,5	280	4000	
HX05FOS12L	8	5/16"	-05	M18x1,5	12L	24	52	22	9x1,5	280	4000	
HX06FOS10L*	10	3/8"	-06	M16x1,5	10L	23	54	19	7,5x1,5	280	4000	
HX06FOS12L	10	3/8"	-06	M18x1,5	12L	24	54	22	9x1,5	280	4000	
HX06FOS15L	10	3/8"	-06	M22x1,5	15L	24	54	27	12x2	280	4000	
HX08FOS15L	12,5	1/2"	-08	M22x1,5	15L	24	57	27	12x2	280	4000	
HX08FOS18L	12,5	1/2"	-08	M26x1,5	18L	26	59	32	15x2	210	3000	
HX10FOS18L	16	5/8"	-10	M26x1,5	18L	27	62	32	15x2	210	3000	
HX10FOS22L	16	5/8"	-10	M30x2	22L	28	64	36	20x2	210	3000	
HX12FOS18LP*	19	3/4"	-12	M26x1,5	18L	34	75	32	15x2	210	3000	
HX12FOS22L	19	3/4"	-12	M30x2	22L	31	71	36	20x2	210	3000	
HX16FOS28L	25	1"	-16	M36x2	28L	32	83	41	26x2	165	2400	
HX20FOS35L	31,5	1 1/4"	-20	M45x2	35L	36	94	50	32x2,5	100	1450	
HX24FOS42L	38	1 1/2"	-24	M52x2	42L	37	102	60	38x2,5	100	1450	

* Crimped-back nut

* Dado pressato

FOS-S
METRIC FEMALE 24° O-RING CONE - HEAVY DUTY - SLIP-ON NUT
 FEMMINA METRICA OGIVA 24° O-RING - SERIE PESANTE - DADO LIBERO

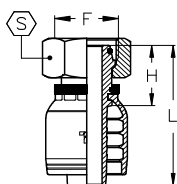
DKOS

TIEFFE Part.N.	Hose Size			METRIC 24° Connection		Dimensions (mm)					Maximum W.P.	
	DN	Inch	Dash	F	Pipe	H	L	S	O-RING	bar	PSI	
HX03FOS6S	5	3/16"	-03	M14x1,5	6S	21	46	17	5x1	415	6000	
HX03FOS8S	5	3/16"	-03	M16x1,5	8S	21	46	19	6x1,5	415	6000	
HX04FOS6S*	6,3	1/4"	-04	M14x1,5	6S	23	51	17	5x1	400	5800	
HX04FOS8S	6,3	1/4"	-04	M16x1,5	8S	22	50	19	6x1,5	400	5800	
HX04FOS10S	6,3	1/4"	-04	M18x1,5	10S	24	52	22	7,5x1,5	400	5800	
HX04FOS12S	6,3	1/4"	-04	M20x1,5	12S	24	52	24	9x1,5	400	5800	
HX05FOS10S	8	5/16"	-05	M18x1,5	10S	24	52	22	7,5x1,5	350	5000	
HX05FOS12S	8	5/16"	-05	M20x1,5	12S	24	52	24	9x1,5	350	5000	
HX06FOS10S*	10	3/8"	-06	M18x1,5	10S	25	55	22	7,5x1,5	330	4800	
HX06FOS12S	10	3/8"	-06	M20x1,5	12S	24	54	24	9x1,5	330	4800	
HX06FOS14S	10	3/8"	-06	M22x1,5	14S	28	58	27	10x2	330	4800	
HX08FOS14S	12,5	1/2"	-08	M22x1,5	14S	28	61	27	10x2	280	4000	
HX08FOS16S	12,5	1/2"	-08	M24x1,5	16S	29	62	30	12x2	280	4000	
HX10FOS20S	16	5/8"	-10	M30x2	20S	33	69	36	16,3x2,4	280	4000	
HX12FOS20S	19	3/4"	-12	M30x2	20S	36	76	36	16,3x2,4	280	4000	
HX12FOS25S	19	3/4"	-12	M36x2	25S	38	78	46	20,3x2,4	280	4000	
HX12FOS25SE41	19	3/4"	-12	M36x2	25S	38	78	41	20,3x2,4	280	4000	
HX16FOS25S	25	1"	-16	M36x2	25S	40	91	46	22x2	210	3000	
HX16FOS30S	25	1"	-16	M42x2	30S	40	91	50	25,3x2,4	210	3000	
HX20FOS30S	31,5	1 1/4"	-20	M42x2	30S	41	99	50	25,3x2,4	125	1800	
HX20FOS38S	31,5	1 1/4"	-20	M52x2	38S	45	103	60	33,3x2,4	125	1800	
HX24FOS38S	38	1 1/2"	-24	M52x2	38S	46	110	60	33,3x2,4	100	1450	

* Crimped-back nut

* Dado pressato

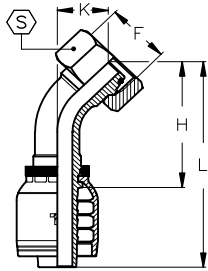
FOS-L45
METRIC FEMALE 24° O'RING CONE - 45° ELBOW - LIGHT DUTY - SLIP-ON NUT
FEMMINA METRICA OGIVA 24° O'RING - CURVA A 45° - SERIE LEGGERA - DADO LIBERO
DKOL45

TIEFFE Part.N.	Hose Size			METRIC 24° Connection		Dimensions (mm)					Maximum W.P.	
	DN	Inch	Dash	F	Pipe	H	L	K	S	O-RING	bar	PSI
HX03FOS6L45	5	3/16"	-03	M12x1,5	6L	34	59	14	14	5x1	280	4000
HX03FOS8L45	5	3/16"	-03	M14x1,5	8L	35	60	14	17	6x1,5	280	4000
HX04FOS6L45*	6,3	1/4"	-04	M12x1,5	6L	35	63	14	17	5x1	280	4000
HX04FOS8L45	6,3	1/4"	-04	M14x1,5	8L	36	64	14	17	6x1,5	280	4000
HX04FOS10L45	6,3	1/4"	-04	M16x1,5	10L	38	66	16	19	7,5x1,5	280	4000
HX04FOS12L45	6,3	1/4"	-04	M18x1,5	12L	39	67	17	22	9x1,5	280	4000
HX05FOS10L45	8	5/16"	-05	M16x1,5	10L	39	67	17	19	7,5x1,5	280	4000
HX05FOS12L45	8	5/16"	-05	M18x1,5	12L	39	67	18	22	9x1,5	280	4000
HX06FOS10L45*	10	3/8"	-06	M16x1,5	10L	39	69	16	19	7,5x1,5	280	4000
HX06FOS12L45	10	3/8"	-06	M18x1,5	12L	40	71	18	22	9x1,5	280	4000
HX06FOS15L45	10	3/8"	-06	M22x1,5	15L	42	72	19	27	12x2	280	4000
HX08FOS15L45	12,5	1/2"	-08	M22x1,5	15L	46	79	19	27	12x2	280	4000
HX08FOS18L45	12,5	1/2"	-08	M26x1,5	18L	47	80	21	32	15x2	210	3000
HX10FOS18L45	16	5/8"	-10	M26x1,5	18L	53	89	22	32	15x2	210	3000
HX10FOS22L45	16	5/8"	-10	M30x2	22L	54	90	23	36	20x2	210	3000
HX12FOS18LP45*	19	3/4"	-12	M26x1,5	18L	66	107	29	32	15x2	210	3000
HX12FOS22L45	19	3/4"	-12	M30x2	22L	62	103	25	36	20x2	210	3000
HX16FOS28L45	25	1"	-16	M36x2	28L	80	131	31	41	26x2	165	2400
HX20FOS35L45	31,5	1 1/4"	-20	M45x2	35L	96	154	40	50	32x2,5	100	1450
HX24FOS42L45	38	1 1/2"	-24	M52x2	42L	115	179	48	60	38x2,5	100	1450

* Crimped-back nut

* Dado pressato

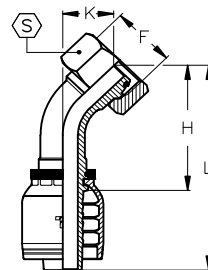
FOS-S45
METRIC FEMALE 24° O'RING CONE - 45° ELBOW - HEAVY DUTY - SLIP-ON NUT
FEMMINA METRICA OGIVA 24° O'RING - CURVA A 45° - SERIE PESANTE - DADO LIBERO
DKOS45

TIEFFE Part.N.	Hose Size			METRIC 24° Connection		Dimensions (mm)					Maximum W.P.	
	DN	Inch	Dash	F	Pipe	H	L	K	S	O-RING	bar	PSI
HX03FOS6S45	5	3/16"	-03	M14x1,5	6S	34	59	14	17	5x1	415	6000
HX03FOS8S45	5	3/16"	-03	M16x1,5	8S	35	60	14	19	6x1,5	415	6000
HX04FOS6S45*	6,3	1/4"	-04	M14x1,5	6S	35	63	14	17	5x1	400	5800
HX04FOS8S45	6,3	1/4"	-04	M16x1,5	8S	36	64	14	19	6x1,5	400	5800
HX04FOS10S45	6,3	1/4"	-04	M18x1,5	10S	38	66	16	22	7,5x1,5	400	5800
HX04FOS12S45	6,3	1/4"	-04	M20x1,5	12S	39	67	17	24	9x1,5	400	5800
HX05FOS10S45	8	5/16"	-05	M18x1,5	10S	39	67	17	22	7,5x1,5	350	5000
HX05FOS12S45	8	5/16"	-05	M20x1,5	12S	39	67	18	24	9x1,5	350	5000
HX06FOS10S45*	10	3/8"	-06	M18x1,5	10S	40	70	17	22	7,5x1,5	330	4800
HX06FOS12S45	10	3/8"	-06	M20x1,5	12S	40	71	18	24	9x1,5	330	4800
HX06FOS14S45	10	3/8"	-06	M22x1,5	14S	42	72	19	27	10x2	330	4800
HX08FOS14S45	12,5	1/2"	-08	M22x1,5	14S	46	79	20	27	10x2	280	4000
HX08FOS16S45	12,5	1/2"	-08	M24x1,5	16S	47	80	21	30	12x2	280	4000
HX10FOS20S45	16	5/8"	-10	M30x2	20S	56	92	25	36	16,3x2,4	280	4000
HX12FOS20S45	19	3/4"	-12	M30x2	20S	64	105	27	36	16,3x2,4	280	4000
HX12FOS25S45	19	3/4"	-12	M36x2	25S	64	105	28	46	20,3x2,4	280	4000
HX12FOS25S45E41	19	3/4"	-12	M36x2	25S	64	105	28	41	20,3x2,4	280	4000
HX16FOS25S45	25	1"	-16	M36x2	25S	82	133	34	41	22x2	210	3000
HX16FOS30S45	25	1"	-16	M42x2	30S	80	131	31	50	25,3x2,4	210	3000
HX20FOS30S45	31,5	1 1/4"	-20	M42x2	30S	96	154	41	50	25,3x2,4	125	1800
HX20FOS38S45	31,5	1 1/4"	-20	M52x2	38S	94	152	38	60	33,3x2,4	125	1800
HX24FOS38S45	38	1 1/2"	-24	M52x2	38S	115	180	49	60	33,3x2,4	100	1450

* Crimped-back nut

* Dado pressato

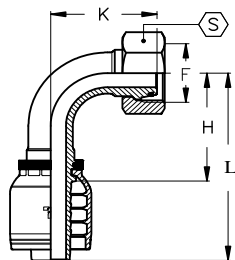
FOS-L90
METRIC FEMALE 24° O'RING CONE - 90° ELBOW - LIGHT DUTY - SLIP-ON NUT
FEMMINA METRICA OGIVA 24° O'RING - CURVA A 90° - SERIE LEGGERA - DADO LIBERO
DKOL90

TIEFFE Part.N.	Hose Size			METRIC 24° Connection		Dimensions (mm)					Maximum W.P.	
	DN	Inch	Dash	F	Pipe	H	L	K	S	O-RING	bar	PSI
HX03FOS6L90	5	3/16"	-03	M12x1,5	6L	27	52	28	14	5x1	280	4000
HX03FOS8L90	5	3/16"	-03	M14x1,5	8L	27	52	28	17	6x1,5	280	4000
HX04FOS6L90*	6,3	1/4"	-04	M12x1,5	6L	26	53	26	17	5x1	280	4000
HX04FOS8L90	6,3	1/4"	-04	M14x1,5	8L	29	57	29	17	6x1,5	280	4000
HX04FOS10L90	6,3	1/4"	-04	M16x1,5	10L	29	57	30	19	7,5x1,5	280	4000
HX04FOS12L90	6,3	1/4"	-04	M18x1,5	12L	29	57	32	22	9x1,5	280	4000
HX05FOS10L90	8	5/16"	-05	M16x1,5	10L	31	59	33	19	7,5x1,5	280	4000
HX05FOS12L90	8	5/16"	-05	M18x1,5	12L	28	56	32	22	9x1,5	280	4000
HX06FOS10L90*	10	3/8"	-06	M16x1,5	10L	31	61	31	19	7,5x1,5	280	4000
HX06FOS12L90	10	3/8"	-06	M18x1,5	12L	31	61	33	22	9x1,5	280	4000
HX06FOS15L90	10	3/8"	-06	M22x1,5	15L	31	61	35	27	12x2	280	4000
HX08FOS15L90	12,5	1/2"	-08	M22x1,5	15L	37	70	38	27	12x2	280	4000
HX08FOS18L90	12,5	1/2"	-08	M26x1,5	18L	37	70	40	32	15x2	210	3000
HX10FOS18L90	16	5/8"	-10	M26x1,5	18L	44	80	45	32	15x2	210	3000
HX10FOS22L90	16	5/8"	-10	M30x2	22L	44	80	47	36	20x2	210	3000
HX12FOS18LP90*	19	3/4"	-12	M26x1,5	18L	54	94	57	32	15x2	210	3000
HX12FOS22L90	19	3/4"	-12	M30x2	22L	54	94	52	36	20x2	210	3000
HX16FOS28L90	25	1"	-16	M36x2	28L	70	121	66	41	26x2	165	2400
HX20FOS35L90	31,5	1 1/4"	-20	M45x2	35L	84	141	83	50	32x2,5	100	1450
HX24FOS42L90	38	1 1/2"	-24	M52x2	42L	100	164	100	60	38x2,5	100	1450

* Crimped-back nut

* Dado pressato

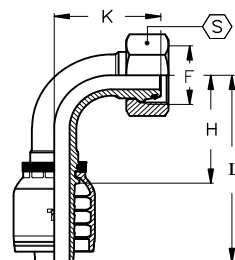
FOS-S90
METRIC FEMALE 24° O'RING CONE - 90° ELBOW - HEAVY DUTY - SLIP-ON NUT
FEMMINA METRICA OGIVA 24° O'RING - CURVA A 90° - SERIE PESANTE - DADO LIBERO
DKOS90

TIEFFE Part.N.	Hose Size			METRIC 24° Connection		Dimensions (mm)					Maximum W.P.	
	DN	Inch	Dash	F	Pipe	H	L	K	S	O-RING	bar	PSI
HX03FOS6S90	5	3/16"	-03	M14x1,5	6S	27	52	28	17	5x1	415	6000
HX03FOS8S90	5	3/16"	-03	M16x1,5	8S	27	52	28	19	6x1,5	415	6000
HX04FOS6S90*	6,3	1/4"	-04	M14x1,5	6S	25	53	26	17	5x1	400	5800
HX04FOS8S90	6,3	1/4"	-04	M16x1,5	8S	29	57	29	19	6x1,5	400	5800
HX04FOS10S90	6,3	1/4"	-04	M18x1,5	10S	29	57	30	22	7,5x1,5	400	5800
HX04FOS12S90	6,3	1/4"	-04	M20x1,5	12S	29	57	32	24	9x1,5	400	5800
HX05FOS10S90	8	5/16"	-05	M18x1,5	10S	31	59	33	22	7,5x1,5	350	5000
HX05FOS12S90	8	5/16"	-05	M20x1,5	12S	28	56	32	24	9x1,5	350	5000
HX06FOS10S90*	10	3/8"	-06	M18x1,5	10S	30	61	33	22	7,5x1,5	330	4800
HX06FOS12S90	10	3/8"	-06	M20x1,5	12S	31	61	33	24	9x1,5	330	4800
HX06FOS14S90	10	3/8"	-06	M22x1,5	14S	34	64	37	27	10x2	330	4800
HX08FOS14S90	12,5	1/2"	-08	M22x1,5	14S	39	71	41	27	10x2	280	4000
HX08FOS16S90	12,5	1/2"	-08	M24x1,5	16S	39	71	42	30	12x2	280	4000
HX10FOS20S90	16	5/8"	-10	M30x2	20S	44	80	49	36	16,3x2,4	280	4000
HX12FOS20S90	19	3/4"	-12	M30x2	20S	54	94	55	36	16,3x2,4	280	4000
HX12FOS25S90	19	3/4"	-12	M36x2	25S	54	94	57	46	20,3x2,4	280	4000
HX12FOS25S90E41	19	3/4"	-12	M36x2	25S	54	94	57	41	20,3x2,4	280	4000
HX16FOS25S90	25	1"	-16	M36x2	25S	70	121	70	46	22x2	210	3000
HX16FOS30S90	25	1"	-16	M42x2	30S	70	121	66	50	25,3x2,4	210	3000
HX20FOS30S90	31,5	1 1/4"	-20	M42x2	30S	84	141	84	50	25,3x2,4	125	1800
HX20FOS38S90	31,5	1 1/4"	-20	M52x2	38S	84	141	80	60	33,3x2,4	125	1800
HX24FOS38S90	38	1 1/2"	-24	M52x2	38S	100	164	101	60	33,3x2,4	100	1450

* Crimped-back nut

* Dado pressato

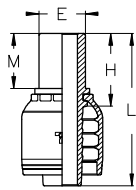
ET
METRIC STANDPIPE - LIGHT/HEAVY DUTY
ESTREMITA' TUBOLARE METRICA - SERIE LEGGERA/PESANTE
**BEL
BES**

TIEFFE Part.N.	Hose Size			Metric PIPE Connection		Dimensions (mm)					Maximum W.P.	
	DN	Inch	Dash	E	Duty	H	L	M			bar	PSI
HX0306ET	5	3/16"	-03	6	L/S	27	52	21			415	6000
HX0308ET	5	3/16"	-03	8	L/S	29	54	23			415	6000
HX0310ET	5	3/16"	-03	10	L/S	31,5	56,5	25			415	6000
HX0406ET	6,3	1/4"	-04	6	L	27,5	55,5	21			280	4000
HX0408ET	6,3	1/4"	-04	8	L/S	29,5	57,5	23			400	5800
HX0410ET	6,3	1/4"	-04	10	L/S	31,5	59,5	25			400	5800
HX0412ET	6,3	1/4"	-04	12	L/S	32	60	25			400	5800
HX0508ET	8	5/16"	-05	8	L/S	30	58	23			350	5000
HX0510ET	8	5/16"	-05	10	L/S	31,5	59,5	25			350	5000
HX0512ET	8	5/16"	-05	12	L/S	31,5	59,5	25			350	5000
HX0608ET	10	3/8"	-06	8	L/S	29,5	60	23			330	4800
HX0610ET	10	3/8"	-06	10	L	28,5	59	22			330	4800
HX0612ET	10	3/8"	-06	12	L/S	31,5	62	25			330	4800
HX0614ET	10	3/8"	-06	14	S	34,5	65	28			330	4800
HX0615ET	10	3/8"	-06	15	L	30,5	61	24			280	4000
HX0616ET	10	3/8"	-06	16	S	36	66,5	29			330	4800
HX0812ET	12,5	1/2"	-08	12	L/S	32,5	65,5	25			280	4000
HX0814ET	12,5	1/2"	-08	14	S	35,5	68,5	28			280	4000
HX0815ET	12,5	1/2"	-08	15	L	31,5	64,5	24			280	4000
HX0816ET	12,5	1/2"	-08	16	S	36,5	69,5	29			280	4000
HX0818ET	12,5	1/2"	-08	18	L	33,5	66,5	26			210	3000
HX1016ET	16	5/8"	-10	16	S	36,5	72,5	29			280	4000
HX1018ET	16	5/8"	-10	18	L	33,5	69,5	26			210	3000
HX1020ET	16	5/8"	-10	20	S	42,5	78,5	35			280	4000
HX1022ET	16	5/8"	-10	22	L	35,5	71,5	28			210	3000
HX1218ET	19	3/4"	-12	18	L	35	75,5	26			210	3000
HX1220ET	19	3/4"	-12	20	S	44	84,5	35			280	4000
HX1222ET	19	3/4"	-12	22	L	37	77,5	28			210	3000
HX1225ET	19	3/4"	-12	25	S	48	88,5	39			280	4000
HX1625ET	25	1"	-16	25	S	49,5	100,5	39			210	3000
HX1628ET	25	1"	-16	28	L	39,5	90,5	29			165	2400
HX1630ET	25	1"	-16	30	S	53,5	104,5	43			210	3000
HX2030ET	31,5	1 1/4"	-20	30	S	54	111,5	43			125	1800
HX2035ET	31,5	1 1/4"	-20	35	L	46	103,5	35			125	1800
HX2038ET	31,5	1 1/4"	-20	38	S	59	116,5	48			125	1800
HX2438ET	38	1 1/2"	-24	38	S	59,5	124	48			100	1450
HX2442ET	38	1 1/2"	-24	42	L	47,5	112	36			100	1450

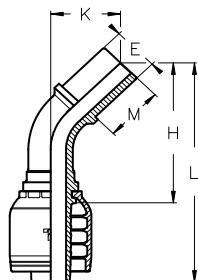
ET45
METRIC STANDPIPE - 45° ELBOW - LIGHT/HEAVY DUTY
ESTREMITA' TUBOLARE METRICA - CURVA A45° - SERIE LEGGERA/PESANTE
BEL45
BES45

TIEFFE Part.N.	Hose Size			Metric PIPE Connection		Dimensions (mm)						Maximum W.P.	
	DN	Inch	Dash	E (mm)	Duty	H	L	K	M			bar	PSI
HX0306ET45	5	3/16"	-03	6	L/S	40	65	21	21			415	6000
HX0308ET45	5	3/16"	-03	8	L/S	41	66	22	23			415	6000
HX0406ET45	6,3	1/4"	-04	6	L	44	72	24	21			280	4000
HX0408ET45	6,3	1/4"	-04	8	L/S	44	72	24	23			400	5800
HX0410ET45	6,3	1/4"	-04	10	L/S	46	74	25	25			400	5800
HX0412ET45	6,3	1/4"	-04	12	L/S	47	75	26	25			400	5800
HX0510ET45	8	5/16"	-05	10	L/S	48	76	26	25			350	5000
HX0512ET45	8	5/16"	-05	12	L/S	48	76	26	25			350	5000
HX0610ET45	10	3/8"	-06	10	L	49	80	26	22			330	4800
HX0612ET45	10	3/8"	-06	12	L/S	50	80	27	25			330	4800
HX0614ET45	10	3/8"	-06	14	S	52	82	29	28			330	4800
HX0615ET45	10	3/8"	-06	15	L	49	80	26	24			280	4000
HX0812ET45	12,5	1/2"	-08	12	S	57	90	30	25			280	4000
HX0814ET45	12,5	1/2"	-08	14	S	58	91	31	28			280	4000
HX0815ET45	12,5	1/2"	-08	15	L	55	88	28	24			280	4000
HX0816ET45	12,5	1/2"	-08	16	S	58	91	32	29			280	4000
HX0818ET45	12,5	1/2"	-08	18	L	56	89	30	26			210	3000
HX1016ET45	16	5/8"	-10	16	S	64	100	33	29			280	4000
HX1018ET45	16	5/8"	-10	18	L	62	98	31	26			210	3000
HX1020ET45	16	5/8"	-10	20	S	68	104	37	35			280	4000
HX1022ET45	16	5/8"	-10	22	L	61	97	30	28			210	3000
HX1218ET45	19	3/4"	-12	18	L	76	116	38	26			210	3000
HX1220ET45	19	3/4"	-12	20	S	76	117	39	35			280	4000
HX1222ET45	19	3/4"	-12	22	L	71	112	34	28			210	3000
HX1225ET45	19	3/4"	-12	25	S	79	119	41	39			280	4000
HX1625ET45	25	1"	-16	25	S	101	152	52	39			210	3000
HX1628ET45	25	1"	-16	28	L	94	145	45	29			165	2400
HX1630ET45	25	1"	-16	30	S	97	148	48	43			210	3000
HX2030ET45	31,5	1 1/4"	-20	30	S	112	170	55	43			125	1800
HX2035ET45	31,5	1 1/4"	-20	35	L	110	168	53	35			125	1800
HX2038ET45	31,5	1 1/4"	-20	38	S	113	171	56	48			125	1800
HX2438ET45	38	1 1/2"	-24	38	S	133	197	65	48			100	1450
HX2442ET45	38	1 1/2"	-24	42	L	124	189	56	36			100	1450

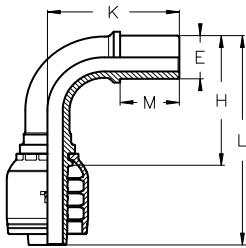
ET90
METRIC STANDPIPE - 90° ELBOW - LIGHT/HEAVY DUTY
ESTREMITA' TUBOLARE METRICA - CURVA A 90° - SERIE LEGGERA/PESANTE
BEL90
BES90

TIEFFE Part.N.	Hose Size			Metric PIPE Connection		Dimensions (mm)						Maximum W.P.	
	DN	Inch	Dash	E (mm)	Duty	H	L	K	M			bar	PSI
HX0306ET90	5	3/16"	-03	6	L/S	21	46	34	21			415	6000
HX0308ET90	5	3/16"	-03	8	L/S	21	46	36	23			415	6000
HX0406ET90	6,3	1/4"	-04	6	L	26	54	39	21			280	4000
HX0408ET90	6,3	1/4"	-04	8	L/S	26	54	39	23			400	5800
HX0410ET90	6,3	1/4"	-04	10	L/S	26	54	41	25			400	5800
HX0412ET90	6,3	1/4"	-04	12	L/S	26	54	43	25			400	5800
HX0510ET90	8	5/16"	-05	10	L/S	28	56	44	25			350	5000
HX0512ET90	8	5/16"	-05	12	L/S	28	56	44	25			350	5000
HX0610ET90	10	3/8"	-06	10	L	31	61	45	22			330	4800
HX0612ET90	10	3/8"	-06	12	L/S	31	61	46	25			330	4800
HX0614ET90	10	3/8"	-06	14	S	31	61	49	28			330	4800
HX0615ET90	10	3/8"	-06	15	L	31	61	45	24			280	4000
HX0812ET90	12,5	1/2"	-08	12	LS	38	71	54	25			280	4000
HX0814ET90	12,5	1/2"	-08	14	S	38	71	55	28			280	4000
HX0815ET90	12,5	1/2"	-08	15	L	38	71	51	24			280	4000
HX0816ET90	12,5	1/2"	-08	16	S	38	71	56	29			280	4000
HX0818ET90	12,5	1/2"	-08	18	L	38	71	53	26			210	3000
HX1016ET90	16	5/8"	-10	16	S	45	80	60	29			280	4000
HX1018ET90	16	5/8"	-10	18	L	45	80	57	26			210	3000
HX1020ET90	16	5/8"	-10	20	S	45	80	66	35			280	4000
HX1022ET90	16	5/8"	-10	22	L	45	80	56	28			210	3000
HX1218ET90	19	3/4"	-12	18	L	54	95	70	26			210	3000
HX1220ET90	19	3/4"	-12	20	S	54	95	70	35			280	4000
HX1222ET90	19	3/4"	-12	22	L	54	95	64	28			210	3000
HX1225ET90	19	3/4"	-12	25	S	54	95	75	39			280	4000
HX1625ET90	25	1"	-16	25	S	70	121	96	39			210	3000
HX1628ET90	25	1"	-16	28	L	70	121	86	29			165	2400
HX1630ET90	25	1"	-16	30	S	70	121	90	43			210	3000
HX2030ET90	31,5	1 1/4"	-20	30	S	84	142	103	43			125	1800
HX2035ET90	31,5	1 1/4"	-20	35	L	84	142	100	35			125	1800
HX2038ET90	31,5	1 1/4"	-20	38	S	84	142	105	48			125	1800
HX2438ET90	38	1 1/2"	-24	38	S	100	165	123	48			100	1450
HX2442ET90	38	1 1/2"	-24	42	L	100	165	111	36			100	1450

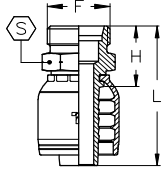
MF
METRIC MALE 24° CONE SEAT - FRENCH GAZ TYPE
MASCHIO METRICO SVASATO 24° - TIPO GAZ FRANCESE
AGF

TIEFFE Part.N.	Hose Size			METRIC 24° French Gaz Connection		Dimensions (mm)				Maximum W.P.	
	DN	Inch	Dash	F	Pipe	H	L	S		bar	PSI
HX0413MF	6,3	1/4"	-04	M20x1,5	13,25	25	53	22		400	5800
HX0513MF	8	5/16"	-05	M20x1,5	13,25	25	53	22		350	5000
HX0613MF	10	3/8"	-06	M20x1,5	13,25	25	55,5	22		330	4800
HX0617MF	10	3/8"	-06	M24x1,5	16,75	26	56,5	24		330	4800
HX0817MF	12,5	1/2"	-08	M24x1,5	16,75	27	60	24		280	4000
HX0821MF	12,5	1/2"	-08	M30x1,5	21,25	30	63	30		280	4000
HX1021MF	16	5/8"	-10	M30x1,5	21,25	30	66	30		280	4000
HX1221MF	19	3/4"	-12	M30x1,5	21,25	31	71,5	30		280	4000
HX1227MF	19	3/4"	-12	M36x1,5	26,75	33	73,5	36		210	3000
HX1633MF	25	1"	-16	M45x1,5	33,5	38,5	89,5	46		210	3000
HX2033MF	31,5	1 1/4"	-20	M45x1,5	33,5	39,5	97	46		125	1800

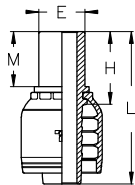
ETF
STANDPIPE - FRENCH GAZ TYPE
ESTREMITA' TUBOLARE - TIPO GAZ FRANCESE
BEF

TIEFFE Part.N.	Hose Size			French Gaz Pipe	Dimensions (mm)				Maximum W.P.		
	DN	Inch	Dash	E	H	L	M			bar	PSI
HX0413ETF	6,3	1/4"	-04	13,25	31	59	24			400	5800
HX0513ETF	8	5/16"	-05	13,25	30,5	58,5	24			350	5000
HX0613ETF	10	3/8"	-06	13,25	30,5	61	24			330	4800
HX0617ETF	10	3/8"	-06	16,75	33	63,5	26			330	4800
HX0817ETF	12,5	1/2"	-08	16,75	33,5	66,5	26			280	4000
HX0821ETF	12,5	1/2"	-08	21,25	36,5	69,5	28			280	4000
HX1021ETF	16	5/8"	-10	21,25	36	71,5	28			280	4000
HX1221ETF	19	3/4"	-12	21,25	37	77,5	28			280	4000
HX1227ETF	19	3/4"	-12	26,75	40,5	81	30			210	3000
HX1633ETF	25	1"	-16	33,5	44	95	32			210	3000
HX2033ETF	31,5	1 1/4"	-20	33,5	43	100,5	32			125	1800

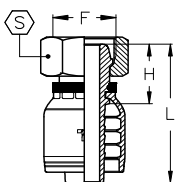
FF
METRIC FEMALE 24° CONE - SLIP-ON NUT - FRENCH GAZ TYPE
FEMMINA METRICA OGIVA 24° - DADO LIBERO - TIPO GAZ FRANCESE
DKF

TIEFFE Part.N.	Hose Size			METRIC 24° French Gaz Connection		Dimensions (mm)				Maximum W.P.	
	DN	Inch	Dash	F	Pipe	H	L	S		bar	PSI
HX0413FF	6,3	1/4"	-04	M20x1,5	13,25	22	50	24		400	5800
HX0513FF	8	5/16"	-05	M20x1,5	13,25	22	50	24		350	5000
HX0613FF	10	3/8"	-06	M20x1,5	13,25	21,5	52	24		330	4800
HX0617FF	10	3/8"	-06	M24x1,5	16,75	25,5	56	30		330	4800
HX0817FF	12,5	1/2"	-08	M24x1,5	16,75	25,5	58,5	30		280	4000
HX0821FF	12,5	1/2"	-08	M30x1,5	21,25	26,5	59,5	36		280	4000
HX1021FF	16	5/8"	-10	M30x1,5	21,25	26,5	62	36		280	4000
HX1221FF	19	3/4"	-12	M30x1,5	21,25	27,5	68	36		280	4000
HX1227FF	19	3/4"	-12	M36x1,5	26,75	29	68,5	41		210	3000
HX1633FF	25	1"	-16	M45x1,5	33,5	31,5	82,5	50		210	3000
HX2033FF	31,5	1 1/4"	-20	M45x1,5	33,5	32	89,5	50		125	1800

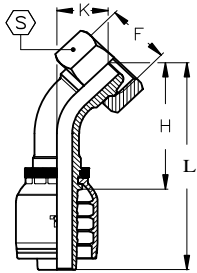
FF45
METRIC FEMALE 24° CONE - 45° ELBOW - SLIP-ON NUT - FRENCH GAZ TYPE
FEMMINA METRICA OGIVA 24° - CURVA A 45° - DADO LIBERO - TIPO GAZ FRANCESE
DKF45

TIEFFE Part.N.	Hose Size			METRIC 24° French Gaz Connection		Dimensions (mm)				Maximum W.P.	
	DN	Inch	Dash	F	Pipe	H	L	K	S	bar	PSI
HX0413FF45	6,3	1/4"	-04	M20x1,5	13,25	38	66	16	24	400	5800
HX0513FF45	8	5/16"	-05	M20x1,5	13,25	38,5	66,5	16,5	24	350	5000
HX0613FF45	10	3/8"	-06	M20x1,5	13,25	39,5	70	16,5	24	330	4800
HX0617FF45	10	3/8"	-06	M24x1,5	16,75	43	73,5	20	30	330	4800
HX0817FF45	12,5	1/2"	-08	M24x1,5	16,75	47	80	20,5	30	280	4000
HX0821FF45	12,5	1/2"	-08	M30x1,5	21,25	48,5	81,5	22	36	280	4000
HX1021FF45	16	5/8"	-10	M30x1,5	21,25	52,5	88,5	22	36	280	4000
HX1221FF45	19	3/4"	-12	M30x1,5	21,25	60	100,5	23	36	280	4000
HX1227FF45	19	3/4"	-12	M36x1,5	26,75	62	103	25	41	210	3000
HX1633FF45	25	1"	-16	M45x1,5	33,5	78,5	130	30,5	50	210	3000
HX2033FF45	31,5	1 1/4"	-20	M45x1,5	33,5	94	152	38	50	125	1800

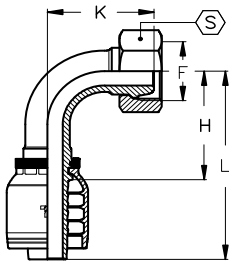
FF90
METRIC FEMALE 24° CONE - 90° ELBOW - SLIP-ON NUT - FRENCH GAZ TYPE
FEMMINA METRICA OGIVA 24° - CURVA A 90° - DADO LIBERO - TIPO GAZ FRANCESE
DKF90

TIEFFE Part.N.	Hose Size			METRIC 24° French Gaz Connection		Dimensions (mm)				Maximum W.P.	
	DN	Inch	Dash	F	Pipe	H	L	K	S	bar	PSI
HX0413FF90	6,3	1/4"	-04	M20x1,5	13,25	26,5	54,5	29	24	400	5800
HX0513FF90	8	5/16"	-05	M20x1,5	13,25	28	56	30	24	350	5000
HX0613FF90	10	3/8"	-06	M20x1,5	13,25	30,5	61	31,5	24	330	4800
HX0617FF90	10	3/8"	-06	M24x1,5	16,75	30,5	61	37	30	330	4800
HX0817FF90	12,5	1/2"	-08	M24x1,5	16,75	37	70	40	30	280	4000
HX0821FF90	12,5	1/2"	-08	M30x1,5	21,25	37	70	42	36	280	4000
HX1021FF90	16	5/8"	-10	M30x1,5	21,25	44,5	80	44,5	36	280	4000
HX1221FF90	19	3/4"	-12	M30x1,5	21,25	53,5	94	48,5	36	280	4000
HX1227FF90	19	3/4"	-12	M36x1,5	26,75	53,5	94	52	41	210	3000
HX1633FF90	25	1"	-16	M45x1,5	33,5	69,5	120,5	64,5	50	210	3000
HX2033FF90	31,5	1 1/4"	-20	M45x1,5	33,5	84	141,5	80,5	50	125	1800

NO-SKIVE

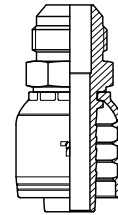

HX

NO-SKIVE





RUBBER HOSES STEEL WIRE BRAIDED - TUBI GOMMA TRECCIATI ACCIAIO

Hose Size			ISO 11237 1SC			ISO 11237 2SC			ISO 1436 1SN SAE100 R1AT			ISO 1436 2SN SAE100 R2AT						Collapse control mandrel Spina controllo collasso		
			"HX" Fitting Raccordo "HX"	Skiving length Lungh. di pelatura	Ø Swage (Ref.) Ø Press. (Rif.)	"HX" Fitting Raccordo "HX"	Skiving length Lungh. di pelatura	Ø Swage (Ref.) Ø Press. (Rif.)	"HX" Fitting Raccordo "HX"	Skiving length Lungh. di pelatura	Ø Swage (Ref.) Ø Press. (Rif.)	"HX" Fitting Raccordo "HX"	Skiving length Lungh. di pelatura	Ø Swage (Ref.) Ø Press. (Rif.)						
DN	Inch	Dash	Part.N.	mm	mm	Part.N.	mm	mm	Part.N.	mm	mm	Part.N.	mm	mm						Part.N.
5	3/16"	-03							HX03	no skive	14,2	HX03	no skive	15,2						SCP03
6,3	1/4"	-04	HX04	no-skive	16,8	HX04	no-skive	17,3	HX04	no-skive	17,2	HX04	no-skive	18,5						SCP04
8	5/16"	-05	HX05	no-skive	17,2	HX05	no-skive	18,5	HX05	no-skive	18,2	HX05	no-skive	19,6						SCP05
10	3/8"	-06	HX06	no-skive	19,9	HX06	no-skive	21,1	HX06	no-skive	20,9	HX06	no-skive	22,3						SCP06
12,5	1/2"	-08	HX08	no-skive	23,6	HX08	no-skive	24,5	HX08	no-skive	24,4	HX08	no-skive	25,8						SCP08
16	5/8"	-10	HX10	no-skive	25,8	HX10	no-skive	27,4	HX10	no-skive	27,2	HX10	no-skive	28,7						SCP10
19	3/4"	-12	HX12	no-skive	30	HX12	no-skive	31,7	HX12	no-skive	31,6	HX12	no-skive	33						SCP12
25	1"	-16	HX16	no-skive	38,4	HX16	no-skive	39,9	HX16	no-skive	40,1	HX16	no-skive	42,3						SCP16
31,5	1 1/4"	-20							HX20	no-skive	48,6	HX20	no-skive	52,8						SCP20
38	1 1/2"	-24							HX24	no-skive	55,3	HX24	no-skive	58,6						SCP24
51	2"	-32							HX32	no-skive	68	HX32	no-skive	71						SCP32



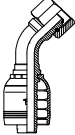

For **R16 - R17 - R19** and other compact braided hoses applications, contact TIEFFE.

Per applicazioni **R16 - R17 - R19** ed altri tubi trecciati compatti, contattare la TIEFFE.

BRITISH STANDARD CONNECTIONS

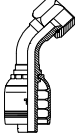
REFERENCE	DESCRIPTION	PAGE	REFERENCE	DESCRIPTION	PAGE
HSN-MGC	 <p>BSP TAPERED MALE 60° CONE SEAT MASCHIO GAS CONICO SVASATO 60°</p>	187	HSN-FGO	 <p>BSP FEMALE 60° O'RING CONE TIEFFE NUT BS 5200 - ISO 12151-6 FEMMINA GAS OGIVA 60° O'RING DADO TIEFFE BS 5200 - ISO 12151-6</p>	188
HSN-MG	 <p>BSP PARALLEL MALE 60° CONE SEAT BS 5200 - ISO 12151-6 MASCHIO GAS CILINDRICO SVASATO 60° BS 5200 - ISO 12151-6</p>	187	HSN-FGO45	 <p>BSP FEMALE 60° O RING CONE 45° ELBOW - TIEFFE NUT BS 5200 - ISO 12151-6 FEMMINA GAS OGIVA 60° O-RING CURVA A 45° - DADO TIEFFE BS 5200 - ISO 12151-6</p>	188
			HSN-FGO90	 <p>BSP FEMALE 60° O RING CONE 90° ELBOW - TIEFFE NUT BS 5200 - ISO 12151-6 FEMMINA GAS OGIVA 60° O-RING CURVA A 90° - DADO TIEFFE BS 5200 - ISO 12151-6</p>	188

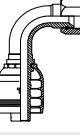

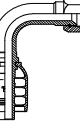
AMERICAN STANDARD CONNECTIONS - NPTF - JIC 37°

REFERENCE	DESCRIPTION	PAGE	REFERENCE	DESCRIPTION	PAGE
HSN-NPT	 <p>NPTF MALE 60° CONE SEAT SAE J516 MASCHIO NPTF SVASATO 60° SAE J516</p>	189	HSN-FIS45	 <p>JIC FEMALE 37° CONE SEAT 45° ELBOW - TIEFFE NUT SAE J516 - ISO 12151-5 FEMMINA JIC SVASATA 37° CURVA A 45° - DADO TIEFFE SAE J516 - ISO 12151-5</p>	190
HSN-MI	 <p>JIC MALE 37° CONE SAE J516 - ISO 12151-5 MASCHIO JIC CONO 37° SAE J516 - ISO 12151-5</p>	189	HSN-FIS90	 <p>JIC FEMALE 37° CONE SEAT 90° ELBOW - TIEFFE NUT SAE J516 - ISO 12151-5 FEMMINA JIC SVASATA 37° CURVA A 90° - DADO TIEFFE SAE J516 - ISO 12151-5</p>	191
HSN-FIC	 <p>JIC FEMALE 37° CONE SEAT DOUBLE EXAGON - TIEFFE NUT SAE J516 - ISO 12151-5 FEMMINA JIC SVASATA 37° DOPPIO ESAGONO - DADO TIEFFE SAE J516 - ISO 12151-5</p>	190	HSN-FIS90-K-	 <p>JIC FEMALE 37° CONE SEAT 90° ELBOW - LONG DROP - TIEFFE NUT SAE J516 - ISO 12151-5 FEMMINA JIC SVASATA 37° CURVA A 90° - LUNGA - DADO TIEFFE SAE J516 - ISO 12151-5</p>	191

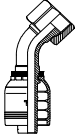
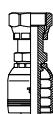
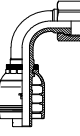
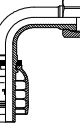

AMERICAN STANDARD CONNECTIONS - ORFS (SAE J516 / ISO 12151-1)

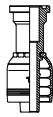
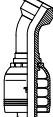
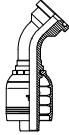
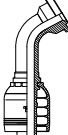
REFERENCE	DESCRIPTION	PAGE	REFERENCE	DESCRIPTION	PAGE
HSN-MRS	 <p>ORFS MALE MASCHIO ORFS</p>	192	HSN-FRS45	 <p>ORFS FEMALE 45° ELBOW - SLIP-ON NUT FEMMINA ORFS CURVA A 45° - DADO LIBERO</p>	193
HSN-FRC	 <p>ORFS FEMALE DOUBLE EXAGON - CRIMPED-BACK NUT FEMMINA ORFS DOPPIO ESAGONO - DADO PRESSATO</p>	192	HSN-FRS90	 <p>ORFS FEMALE 90° ELBOW - SHORT DROP SLIP-ON NUT FEMMINA ORFS CURVA A 90° - CORTA DADO LIBERO</p>	193
			HSN-FRS90-K-	 <p>ORFS FEMALE 90° ELBOW - LONG DROP SLIP-ON NUT FEMMINA ORFS CURVA A 90° - LUNGA DADO LIBERO</p>	193

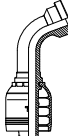
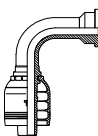
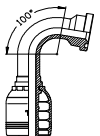
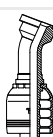
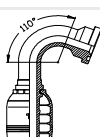
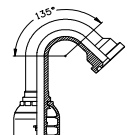

AMERICAN STANDARD CONNECTIONS - FLANGE CODE 61 (SAE J516 / ISO 12151-3)

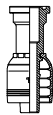
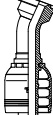
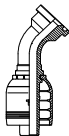
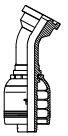
REFERENCE	DESCRIPTION	PAGE	REFERENCE	DESCRIPTION	PAGE
HSN-FL	 SAE CODE 61 FLANGE FLANGIA SAE CODE 61	194	HSN-FL30	 SAE CODE 61 FLANGE 30° ELBOW FLANGIA SAE CODE 61 CURVA A 30°	196
HSN-FL45	 SAE CODE 61 FLANGE 45° ELBOW FLANGIA SAE CODE 61 CURVA A 45°	194	HSN-FL60	 SAE CODE 61 FLANGE 60° ELBOW FLANGIA SAE CODE 61 CURVA A 60°	197
HSN-FL90	 SAE CODE 61 FLANGE 90° ELBOW FLANGIA SAE CODE 61 CURVA A 90°	195	HSN-FL67	 SAE CODE 61 FLANGE 67,5° ELBOW FLANGIA SAE CODE 61 CURVA A 67,5°	197
HSN-FL90-K-	 SAE CODE 61 FLANGE 90° ELBOW - LONG DROP FLANGIA SAE CODE 61 CURVA A 90° - LUNGA	195	HSN-FL100	 SAE CODE 61 FLANGE 100° ELBOW FLANGIA SAE CODE 61 CURVA A 100°	198
HSN-FL22	 SAE CODE 61 FLANGE 22,5° ELBOW FLANGIA SAE CODE 61 CURVA A 22,5°	196	HSN-FL110	 SAE CODE 61 FLANGE 110° ELBOW - LONG DROP FLANGIA SAE CODE 61 CURVA A 110° - LUNGA	198
			HSN-FL135	 SAE CODE 61 FLANGE 135° ELBOW FLANGIA SAE CODE 61 CURVA A 135°	198

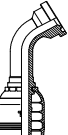
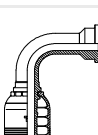
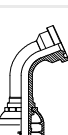
AMERICAN STANDARD CONNECTIONS - FLANGE CODE 62 (SAE J516 / ISO 12151-3)

REFERENCE	DESCRIPTION	PAGE	REFERENCE	DESCRIPTION	PAGE
HSN-FP	 SAE CODE 62 FLANGE FLANGIA SAE CODE 62	199	HSN-FP22	 SAE CODE 62 FLANGE 22,5° ELBOW FLANGIA SAE CODE 62 CURVA A 22,5°	201
HSN-FP45	 SAE CODE 62 FLANGE 45° ELBOW FLANGIA SAE CODE 62 CURVA A 45°	199	HSN-FP30	 SAE CODE 62 FLANGE 30° ELBOW FLANGIA SAE CODE 62 CURVA A 30°	201
HSN-FP90	 SAE CODE 62 FLANGE 90° ELBOW FLANGIA SAE CODE 62 CURVA A 90°	200	HSN-FP60	 SAE CODE 62 FLANGE 60° ELBOW FLANGIA SAE CODE 62 CURVA A 60°	202
HSN-FP90-K-	 SAE CODE 62 FLANGE 90° ELBOW - LONG DROP FLANGIA SAE CODE 62 CURVA A 90° - LUNGA	200	HSN-FP67	 SAE CODE 62 FLANGE 67,5° ELBOW FLANGIA SAE CODE 62 CURVA A 67,5°	202

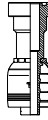
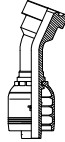
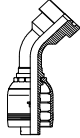
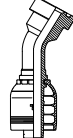
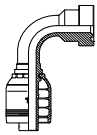
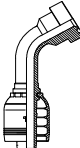
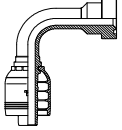
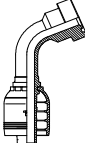
OEM CONNECTIONS - "SUPERCAT" FLANGE

REFERENCE	DESCRIPTION	PAGE	REFERENCE	DESCRIPTION	PAGE
HSN-YP	 "SUPERCAT" FLANGE FLANGIA "SUPERCAT"	203	HSN-YP22	 "SUPERCAT" FLANGE 22,5° ELBOW FLANGIA "SUPERCAT" CURVA A 22,5°	205
HSN-YP45	 "SUPERCAT" FLANGE 45° ELBOW FLANGIA "SUPERCAT" CURVA A 45°	203	HSN-YP30	 "SUPERCAT" FLANGE 30° ELBOW FLANGIA "SUPERCAT" CURVA A 30°	205
HSN-YP90	 "SUPERCAT" FLANGE 90° ELBOW FLANGIA "SUPERCAT" CURVA A 90°	204	HSN-YP60	 "SUPERCAT" FLANGE 60° ELBOW FLANGIA "SUPERCAT" CURVA A 60°	206
HSN-YP90-K-	 "SUPERCAT" FLANGE 90° ELBOW - LONG DROP FLANGIA "SUPERCAT" CURVA A 90° - LUNGA	204	HSN-YP67	 "SUPERCAT" FLANGE 67,5° ELBOW FLANGIA "SUPERCAT" CURVA A 67,5°	206
			DR	 D'RING SEAL FOR "SUPERCAT" FLANGES GUARNIZIONI D'RING PER FLANGE "SUPERCAT"	206

DIN STANDARD CONNECTIONS (DIN20066 / ISO12151-2)

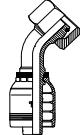
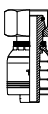
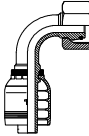
REFERENCE	DESCRIPTION	PAGE	REFERENCE	DESCRIPTION	PAGE
HSN-MM	 METRIC MALE 24° CONE SEAT MASCHIO METRICO SVASATO 24°	207	HSN-FOS45	 METRIC FEMALE 24° O'RING CONE 45° ELBOW - SLIP-ON NUT FEMM. METR. OGIVA 24° O'RING CURVA A 45° - DADO LIBERO	208
HSN-FOS	 METRIC FEMALE 24° O'RING CONE SLIP-ON NUT FEMMINA METRICA OGIVA 24° O'RING DADO LIBERO	207	HSN-FOS90	 METRIC FEMALE 24° O'RING CONE 90° ELBOW - SLIP-ON NUT FEMM. METR. OGIVA 24° O'RING CURVA A 90° - DADO LIBERO	208

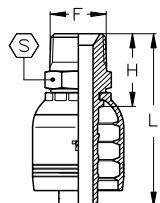
MGC
BSP TAPERED MALE 60° CONE SEAT
MASCHIO GAS CONICO SVASATO 60°
AGR-K

TIEFFE Part.N.	Hose Size			BSP Connection Size		Dimensions (mm)				Maximum W.P.	
	DN	Inch	Dash	F	Dash	H	L	S		bar	PSI
HSN1212MGC	19	3/4"	-12	3/4"-14	-12	37	88	27		280	4000
HSN1616MGC	25	1"	-16	1"-11	-16	44	101	36		280	4000
HSN2020MGC	31,5	1 1/4"	-20	1 1/4"-11	-20	51	118	46		210	3000
HSN2424MGC	38	1 1/2"	-24	1 1/2"-11	-24	54	137	50		185	2700
HSN3232MGC	51	2"	-32	2"-11	-32	64	160	65		175	2500

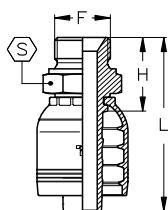
MG
BSP PARALLEL MALE 60° CONE SEAT
MASCHIO GAS CILINDRICO SVASATO 60°
AGR

TIEFFE Part.N.	Hose Size			BSP Connection Size		Dimensions (mm)				Maximum W.P.	
	DN	Inch	Dash	F	Dash	H	L	S		bar	PSI
HSN1212MG	19	3/4"	-12	3/4"-14	-12	38	89	32		420	6000
HSN1216MG	19	3/4"	-12	1"-11	-16	43	94	41		380	5500
HSN1616MG	25	1"	-16	1"-11	-16	45	101	41		380	5500
HSN1620MG	25	1"	-16	1 1/4"-11	-20	48	104	50		325	4700
HSN2020MG	31,5	1 1/4"	-20	1 1/4"-11	-20	50	117	50		325	4700
HSN2024MG	31,5	1 1/4"	-20	1 1/2"-11	-24	53	120	55		290	4200
HSN2424MG	38	1 1/2"	-24	1 1/2"-11	-24	55	138	55		290	4200
HSN3232MG	51	2"	-32	2"-11	-32	63	159	70		250	3600

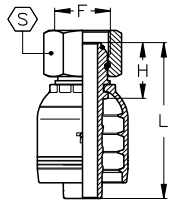
FGO
BSP FEMALE 60° O-RING CONE - TIEFFE NUT
FEMMINA GAS OGIVA 60° O-RING - DADO TIEFFE
DKOR

TIEFFE Part.N.	Hose Size			BSP Connection Size		Dimensions (mm)					Maximum W.P.	
	DN	Inch	Dash	F	Dash	H	L	S	O-RING	bar	PSI	
HSN1212FGO	19	3/4"	-12	3/4"-14	-12	29	80	32		17x1,5	420	6000
HSN1216FGO	19	3/4"	-12	1"-11	-16	33	84	41		22x1,5	380	5500
HSN1616FGO	25	1"	-16	1"-11	-16	34	90	41		22x1,5	380	5500
HSN1620FGO	25	1"	-16	1 1/4"-11	-20	38	95	50		28,3x1,78	325	4700
HSN2020FGO	31,5	1 1/4"	-20	1 1/4"-11	-20	39	106	50		28,3x1,78	325	4700
HSN2024FGO	31,5	1 1/4"	-20	1 1/2"-11	-24	42	109	60		33,05x1,78	290	4200
HSN2424FGO	38	1 1/2"	-24	1 1/2"-11	-24	43	125	60		33,05x1,78	290	4200
HSN3232FGO	51	2"	-32	2"-11	-32	47	143	75		44,17x1,78	250	3600

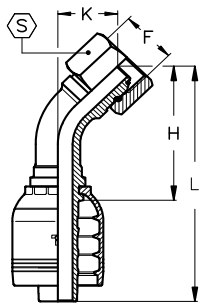
FGO45
BSP FEMALE 60° O-RING CONE - 45° ELBOW - TIEFFE NUT
FEMMINA GAS OGIVA 60° O-RING - CURVA A 45° - DADO TIEFFE
DKOR45

TIEFFE Part.N.	Hose Size			BSP Connection Size		Dimensions (mm)					Maximum W.P.	
	DN	Inch	Dash	F	Dash	H	L	S	K	O-RING	bar	PSI
HSN1212FGO45	19	3/4"	-12	3/4"-14	-12	67	118	29	32	17x1,5	420	6000
HSN1216FGO45	19	3/4"	-12	1"-11	-16	70	121	32	41	22x1,5	380	5500
HSN1616FGO45	25	1"	-16	1"-11	-16	86	142	36	41	22x1,5	380	5500
HSN1620FGO45	25	1"	-16	1 1/4"-11	-20	87	143	37	50	28,3x1,78	325	4700
HSN2020FGO45	31,5	1 1/4"	-20	1 1/4"-11	-20	103	169	43	50	28,3x1,78	325	4700
HSN2024FGO45	31,5	1 1/4"	-20	1 1/2"-11	-24	103	169	43	60	33,05x1,78	290	4200
HSN2424FGO45	38	1 1/2"	-24	1 1/2"-11	-24	123	206	51	60	33,05x1,78	290	4200
HSN3232FGO45	51	2"	-32	2"-11	-32	160	257	65	75	44,17x1,78	250	3600

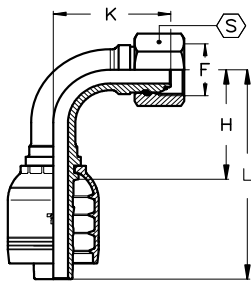
FGO90
BSP FEMALE 60° O-RING CONE - 90° ELBOW - TIEFFE NUT
FEMMINA GAS OGIVA 60° O-RING - CURVA A 90° - DADO TIEFFE
DKOR90

TIEFFE Part.N.	Hose Size			BSP Connection Size		Dimensions (mm)					Maximum W.P.	
	DN	Inch	Dash	F	Dash	H	L	S	K	O-RING	bar	PSI
HSN1212FGO90	19	3/4"	-12	3/4"-14	-12	55	106	57	32	17x1,5	420	6000
HSN1216FGO90	19	3/4"	-12	1"-11	-16	55	106	61	41	22x1,5	380	5500
HSN1616FGO90	25	1"	-16	1"-11	-16	71	128	72	41	22x1,5	380	5500
HSN1620FGO90	25	1"	-16	1 1/4"-11	-20	71	128	74	50	28,3x1,78	325	4700
HSN2020FGO90	31,5	1 1/4"	-20	1 1/4"-11	-20	87	154	88	50	28,3x1,78	325	4700
HSN2024FGO90	31,5	1 1/4"	-20	1 1/2"-11	-24	87	154	88	60	33,05x1,78	290	4200
HSN2424FGO90	38	1 1/2"	-24	1 1/2"-11	-24	105	188	104	60	33,05x1,78	290	4200
HSN3232FGO90	51	2"	-32	2"-11	-32	140	237	137	75	44,17x1,78	250	3600

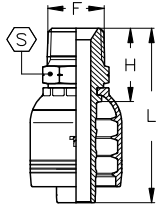
NPT
NPTF MALE 60° CONE SEAT
MASCHIO NPTF SVASATO 60°
AGN

TIEFFE Part.N.	Hose Size			NPTF Connection Size		Dimensions (mm)				Maximum W.P.	
	DN	Inch	Dash	F	Dash	H	L	S		bar	PSI
HSN1212NPT	19	3/4"	-12	3/4"-14	-12	39	90	27		280	4000
HSN1216NPT	19	3/4"	-12	1"-11,5	-16	47	98	36		280	4000
HSN1612NPT	25	1"	-16	3/4"-14	-12	41,5	98	32		280	4000
HSN1616NPT	25	1"	-16	1"-11,5	-16	48,5	105	36		280	4060
HSN1620NPT	25	1"	-16	1 1/4"-11,5	-20	53	109,5	46		210	3000
HSN2016NPT	31,5	1 1/4"	-20	1"-11,5	-16	52,5	119	41		210	3000
HSN2020NPT	31,5	1 1/4"	-20	1 1/4"-11,5	-20	55	121,5	46		210	3000
HSN2024NPT	31,5	1 1/4"	-20	1 1/2"-11,5	-24	59	125,5	50		185	2700
HSN2424NPT	38	1 1/2"	-24	1 1/2"-11,5	-24	61	143,5	50		185	2700
HSN2432NPT	38	1 1/2"	-24	2"-11,5	-32	67,5	150	65		175	2500
HSN3232NPT	51	2"	-32	2"-11,5	-32	70,5	167	65		175	2500

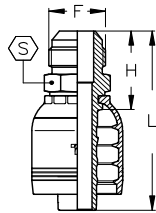
MI
JIC MALE 37° CONE
MASCHIO JIC CONO 37°
AGJ

TIEFFE Part.N.	Hose Size			JIC 37° Connection Size		Dimensions (mm)				Maximum W.P.	
	DN	Inch	Dash	F	Dash	H	L	S		bar	PSI
HSN1210MI	19	3/4"	-12	7/8"-14	-10	37	88	27		350	5000
HSN1212MI	19	3/4"	-12	1 1/16"-12	-12	40	91	27		350	5000
HSN1214MI	19	3/4"	-12	1 3/16"-12	-14	41,5	92,5	32		350	5000
HSN1216MI	19	3/4"	-12	1 5/16"-12	-16	43	94	36		280	4000
HSN1612MI	25	1"	-16	1 1/16"-12	-12	43	99,5	32		350	5000
HSN1616MI	25	1"	-16	1 5/16"-12	-16	45	101,5	36		280	4000
HSN1620MI	25	1"	-16	1 5/8"-12	-20	48	104,5	46		210	3000
HSN2016MI	31,5	1 1/4"	-20	1 5/16"-12	-16	48,5	115	41		280	4000
HSN2020MI	31,5	1 1/4"	-20	1 5/8"-12	-20	50,5	117	46		210	3000
HSN2024MI	31,5	1 1/4"	-20	1 7/8"-12	-24	55	121,5	50		185	2700
HSN2424MI	38	1 1/2"	-24	1 7/8"-12	-24	57	139,5	50		185	2700
HSN2432MI	38	1 1/2"	-24	2 1/2"-12	-32	65,5	148	65		175	2500
HSN3232MI	51	2"	-32	2 1/2"-12	-32	68,5	165	65		175	2500

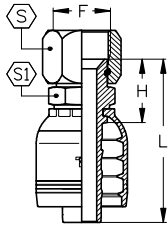
FIC
JIC FEMALE 37° CONE SEAT - DOUBLE EXAGON - TIEFFE NUT
FEMMINA JIC SVASATA 37° - DOPPIO ESAGONO - DADO TIEFFE
DKJ

TIEFFE Part.N.	Hose Size			JIC 37° Connection Size		Dimensions (mm)				Maximum W.P.	
	DN	Inch	Dash	F	Dash	H	L	S	S1	bar	PSI
HSN1210FIC	19	3/4"	-12	7/8"-14	-10	33	84	27	27	350	5000
HSN1212FIC	19	3/4"	-12	1 1/16"-12	-12	34	85	32	27	350	5000
HSN1214FIC	19	3/4"	-12	1 3/16"-12	-14	35,5	86,5	36	30	350	5000
HSN1216FIC	19	3/4"	-12	1 5/16"-12	-16	38	89	41	32	280	4000
HSN1612FIC	25	1"	-16	1 1/16"-12	-12	36,5	93	32	32	350	5000
HSN1616FIC	25	1"	-16	1 5/16"-12	-16	39,5	96	41	32	280	4000
HSN1620FIC	25	1"	-16	1 5/8"-12	-20	46	102,5	50	41	210	3000
HSN2016FIC	31,5	1 1/4"	-20	1 5/16"-12	-16	45,5	112	41	41	280	4000
HSN2020FIC	31,5	1 1/4"	-20	1 5/8"-12	-20	48	114,5	50	41	210	3000
HSN2024FIC	31,5	1 1/4"	-20	1 7/8"-12	-24	51	117,5	60	46	185	2700
HSN2424FIC	38	1 1/2"	-24	1 7/8"-12	-24	53	135,5	60	46	185	2700
HSN2432FIC	38	1 1/2"	-24	2 1/2"-12	-32	66	148,5	75	60	175	2500
HSN3232FIC	51	2"	-32	2 1/2"-12	-32	69	165,5	75	60	175	2500

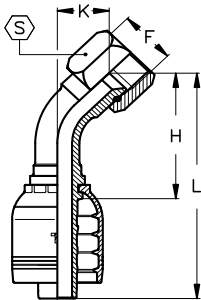
FIS45
JIC FEMALE 37° CONE SEAT - 45° ELBOW - TIEFFE NUT
FEMMINA JIC SVASATA 37° - CURVA A 45° - DADO TIEFFE
DKJ45

TIEFFE Part.N.	Hose Size			JIC 37° Connection Size		Dimensions (mm)				Maximum W.P.	
	DN	Inch	Dash	F	Dash	H	L	K	S	bar	PSI
HSN1210FIS45	19	3/4"	-12	7/8"-14	-10	66	117	28	27	350	5000
HSN1212FIS45	19	3/4"	-12	1 1/16"-12	-12	63	114	25	32	350	5000
HSN1214FIS45	19	3/4"	-12	1 3/16"-12	-14	63	114	25	36	350	5000
HSN1216FIS45	19	3/4"	-12	1 5/16"-12	-16	66	117	28	41	280	4000
HSN1612FIS45	25	1"	-16	1 1/16"-12	-12	85	141	35	32	350	5000
HSN1616FIS45	25	1"	-16	1 5/16"-12	-16	82	138	32	41	280	4000
HSN1620FIS45	25	1"	-16	1 5/8"-12	-20	83	140	33	50	210	3000
HSN2016FIS45	31,5	1 1/4"	-20	1 5/16"-12	-16	100	167	41	41	280	4000
HSN2020FIS45	31,5	1 1/4"	-20	1 5/8"-12	-20	98	164	38	50	210	3000
HSN2024FIS45	31,5	1 1/4"	-20	1 7/8"-12	-24	99	165	39	60	185	2700
HSN2424FIS45	38	1 1/2"	-24	1 7/8"-12	-24	118	201	46	60	185	2700
HSN2432FIS45	38	1 1/2"	-24	2 1/2"-12	-32	122	204	50	75	175	2500
HSN3232FIS45	51	2"	-32	2 1/2"-12	-32	157	253	62	75	175	2500

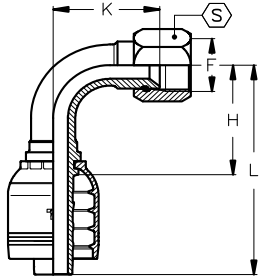
FIS90
JIC FEMALE 37° CONE SEAT - 90° ELBOW - TIEFFE NUT
FEMMINA JIC SVASATA 37° - CURVA A 90° - DADO TIEFFE
DKJ90

TIEFFE Part.N.	Hose Size			JIC 37° Connection Size		Dimensions (mm)				Maximum W.P.	
	DN	Inch	Dash	F	Dash	H	L	K	S	bar	PSI
HSN1210FIS90	19	3/4"	-12	7/8"-14	-10	55	106	55	27	350	5000
HSN1212FIS90	19	3/4"	-12	1 1/16"-12	-12	55	106	52	32	350	5000
HSN1214FIS90	19	3/4"	-12	1 3/16"-12	-14	55	106	52	36	350	5000
HSN1216FIS90	19	3/4"	-12	1 5/16"-12	-16	55	106	56	41	280	4000
HSN1612FIS90	25	1"	-16	1 1/16"-12	-12	71	128	71	32	350	5000
HSN1616FIS90	25	1"	-16	1 5/16"-12	-16	71	128	67	41	280	4000
HSN1620FIS90	25	1"	-16	1 5/8"-12	-20	71	128	69	50	210	3000
HSN2016FIS90	31,5	1 1/4"	-20	1 5/16"-12	-16	87	154	84	41	280	4000
HSN2020FIS90	31,5	1 1/4"	-20	1 5/8"-12	-20	87	154	81	50	210	3000
HSN2024FIS90	31,5	1 1/4"	-20	1 7/8"-12	-24	87	154	82	60	185	2700
HSN2424FIS90	38	1 1/2"	-24	1 7/8"-12	-24	105	188	97	60	185	2700
HSN2432FIS90	38	1 1/2"	-24	2 1/2"-12	-32	105	188	102	75	175	2500
HSN3232FIS90	51	2"	-32	2 1/2"-12	-32	140	237	132	75	175	2500

FIS90

LONG DROP

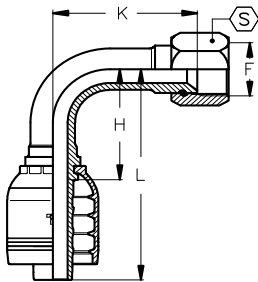
JIC FEMALE 37° CONE SEAT - 90° ELBOW - LONG DROP - CRIMPED-BACK NUT
FEMMINA JIC SVASATA 37° - CURVA A 90° LUNGA - DADO PRESSATO
DKJ90
 LONG DROP

TIEFFE Part.N.	Hose Size			JIC 37° Connection Size		Dimensions (mm)				Maximum W.P.	
	DN	Inch	Dash	F	Dash	H	L	K	S	bar	PSI
HSN1212FIS90-K96	19	3/4"	-12	1 1/16"-12	-12	55	106	96	32	350	5000
HSN1616FIS90-K116	25	1"	-16	1 5/16"-12	-16	71	128	116	41	280	4000
HSN1620FIS90-K116	25	1"	-16	1 5/8"-12	-20	71	128	116	50	210	3000
HSN2020FIS90-K136	31,5	1 1/4"	-20	1 5/8"-12	-20	87	154	136	50	210	3000
HSN2424FIS90-K162	38	1 1/2"	-24	1 7/8"-12	-24	105	188	162	60	185	2700
HSN3232FIS90-K220	51	2"	-32	2 1/2"-12	-32	140	137	220	75	175	2500

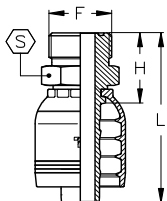
MRS

ORFS MALE
MASCHIO ORFS

AG ORFS

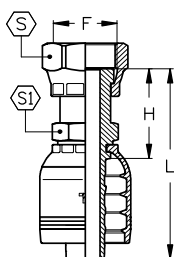
TIEFFE Part.N.	Hose Size			ORFS Connection Size		Dimensions (mm)					Maximum W.P.	
	DN	Inch	Dash	F	Dash	H	L	S	O-RING	bar	PSI	
HSN1212MRS	19	3/4"	-12	1 3/16"-12	-12	36	87	32		18,77x1,78	420	6000
HSN1616MRS	25	1"	-16	1 7/16"-12	-16	41	97	41		23,52x1,78	415	6000
HSN2020MRS	31,5	1 1/4"	-20	1 11/16"-12	-20	44	111	46		29,87x1,78	325	4700
HSN2424MRS	38	1 1/2"	-24	2"-12	-24	48	131	55		37,82x1,78	290	4200

FRC

ORFS FEMALE - DOUBLE EXAGON - CRIMPED-BACK NUT
FEMMINA ORFS - DOPPIO ESAGONO - DADO PRESSATO

DK ORFS

TIEFFE Part.N.	Hose Size			ORFS Connection Size		Dimensions (mm)					Maximum W.P.	
	DN	Inch	Dash	F	Dash	H	L	S	S1		bar	PSI
HSN1210FRC	19	3/4"	-12	1"-14	-10	43	94	30	27		420	6000
HSN1212FRC	19	3/4"	-12	1 3/16"-12	-12	46	97	36	30		420	6000
HSN1216FRC	19	3/4"	-12	1 7/16"-12	-16	49	100	41	36		420	6000
HSN1616FRC	25	1"	-25	1 7/16"-12	-16	51	107	41	36		415	6000
HSN1620FRC	25	1"	-25	1 11/16"-12	-20	52	109	50	41		345	5000
HSN2020FRC	31,5	1 1/4"	-20	1 11/16"-12	-20	55	121	50	41		325	4700
HSN2424FRC	38	1 1/2"	-24	2"-12	-24	60	142	60	50		290	4200

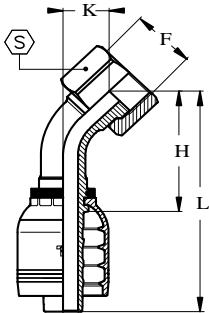
FRS45
ORFS FEMALE - 45° ELBOW - SLIP-ON NUT
 FEMMINA ORFS - CURVA A 45° - DADO LIBERO

DK ORFS 45

TIEFFE Part.N.	Hose Size			ORFS Connection Size		Dimensions (mm)				Maximum W.P.	
	DN	Inch	Dash	F	Dash	H	L	K	S	bar	PSI
HSN1212FRS45	19	3/4"	-12	1 3/16"-12	-12	60	111	22	36	420	6000
HSN1216FRS45	19	3/4"	-12	1 7/16"-12	-16	61	112	23	41	420	6000
HSN1616FRS45	25	1"	-16	1 7/16"-12	-16	78	134	29	41	415	6000
HSN1620FRS45	25	1"	-16	1 11/16"-12	-20	78	134	29	50	345	5000
HSN2020FRS45	31,5	1 1/4"	-20	1 11/16"-12	-20	93	159	34	50	325	4700
HSN2424FRS45	38	1 1/2"	-24	2"-12	-24	113	195	41	60	290	4200

FRS90
ORFS FEMALE - 90° ELBOW - SLIP-ON NUT
 FEMMINA ORFS - CURVA A 90° - DADO LIBERO

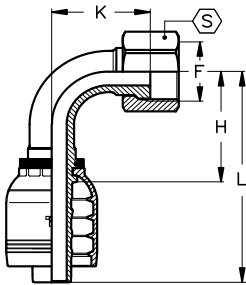
DK ORFS 90

TIEFFE Part.N.	Hose Size			ORFS Connection Size		Dimensions (mm)				Maximum W.P.	
	DN	Inch	Dash	F	Dash	H	L	K	S	bar	PSI
HSN1212FRS90	19	3/4"	-12	1 3/16"-12	-12	54	105	48	36	420	6000
HSN1216FRS90	19	3/4"	-12	1 7/16"-12	-16	54	105	49	41	420	6000
HSN1616FRS90	25	1"	-16	1 7/16"-12	-16	71	127	62	41	415	6000
HSN1620FRS90	25	1"	-16	1 11/16"-12	-20	71	127	62	50	345	5000
HSN2020FRS90	31,5	1 1/4"	-20	1 11/16"-12	-20	87	153	75	50	325	4700
HSN2424FRS90	38	1 1/2"	-24	2"-12	-24	105	187	90	60	290	4200

DK ORFS 90
 LONG DROP

ORFS FEMALE - 90° ELBOW - LONG DROP - SLIP-ON NUT
 FEMMINA ORFS - CURVA A 90° - LUNGA - DADO LIBERO

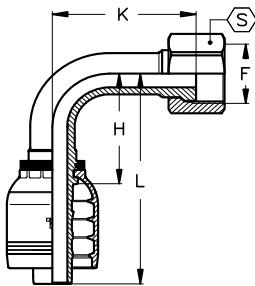
DK ORFS 90
 LONG DROP

TIEFFE Part.N.	Hose Size			ORFS Connection Size		Dimensions (mm)				Maximum W.P.	
	DN	Inch	Dash	F	Dash	H	L	K	S	bar	PSI
HSN1212FRS90-K96	19	3/4"	-12	1 3/16"-12	-12	54	105	96	36	420	6000
HSN1616FRS90-K114	25	1"	-16	1 7/16"-12	-16	71	127	114	41	415	6000
HSN2020FRS90-K130	31,5	1 1/4"	-20	1 11/16"-12	-20	87	153	130	50	325	4700
HSN2424FRS90-K155	38	1 1/2"	-24	2"-12	-24	105	187	155	60	290	4200

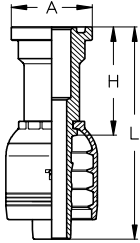
FL
SAE CODE 61 FLANGE
FLANGIA SAE CODE 61
SFL

TIEFFE Part.N.	Hose Size			Flange Size Connection		Dimensions (mm)					Maximum W.P.	
	DN	Inch	Dash	Inch	Dash	H	L	A			bar	PSI
HSN1212FL	19	3/4"	-12	3/4"	-12	55	106	38,1			350	5000
HSN1216FL	19	3/4"	-12	1"	-16	57	108	44,5			350	5000
HSN1220FL	19	3/4"	-12	1 1/4"	-20	55	106	50,8			280	4000
HSN1612FL	25	1"	-16	3/4"	-12	58	114,5	38,1			350	5000
HSN1616FL	25	1"	-16	1"	-16	58	114,5	44,5			350	5000
HSN1620FL	25	1"	-16	1 1/4"	-20	63	119,5	50,8			280	4000
HSN1624FL	25	1"	-16	1 1/2"	-24	55	115,5	60,4			210	3000
HSN2016FL	31,5	1 1/4"	-20	1"	-16	64	130,5	44,5			350	5000
HSN2020FL	31,5	1 1/4"	-20	1 1/4"	-20	64	130,5	50,8			280	4000
HSN2024FL	31,5	1 1/4"	-20	1 1/2"	-24	68	134,5	60,4			210	3000
HSN2032FL	31,5	1 1/4"	-20	2"	-32	75	141,5	71,4			210	3000
HSN2424FL	38	1 1/2"	-24	1 1/2"	-24	73	155,5	60,4			210	3000
HSN2432FL	38	1 1/2"	-24	2"	-32	76	158,5	71,4			210	3000
HSN3232FL	51	2"	-32	2"	-32	77	176,5	71,4			210	3000
HSN3240FL	51	2"	-32	2 1/2"	-40	90	186,5	84,1			175	2500

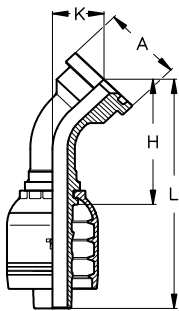
FL45
SAE CODE 61 FLANGE - 45° ELBOW
FLANGIA SAE CODE 61 - CURVA A 45°
SFL45

TIEFFE Part.N.	Hose Size			Flange Size Connection		Dimensions (mm)					Maximum W.P.	
	DN	Inch	Dash	Inch	Dash	H	L	K	A		bar	PSI
HSN1212FL45	19	3/4"	-12	3/4"	-12	63	114	25	38,1		350	5000
HSN1216FL45	19	3/4"	-12	1"	-16	65	116	27	44,5		350	5000
HSN1612FL45	25	1"	-16	3/4"	-12	81	137	31	38,1		350	5000
HSN1616FL45	25	1"	-16	1"	-16	78	134	28	44,5		350	5000
HSN1620FL45	25	1"	-16	1 1/4"	-20	78	134	28	50,8		280	4000
HSN2016FL45	31,5	1 1/4"	-20	1"	-16	96	163	37	44,5		350	5000
HSN2020FL45	31,5	1 1/4"	-20	1 1/4"	-20	91	157	32	50,8		280	4000
HSN2024FL45	31,5	1 1/4"	-20	1 1/2"	-24	91	157	32	60,4		210	3000
HSN2424FL45	38	1 1/2"	-24	1 1/2"	-24	108	191	36	60,4		210	3000
HSN2432FL45	38	1 1/2"	-24	2"	-32	107	189	35	71,4		210	3000
HSN3232FL45	51	2"	-32	2"	-32	151	245	57	71,4		210	3000
HSN3240FL45	51	2"	-32	2 1/2"	-40	146	243	51	84,1		175	2500

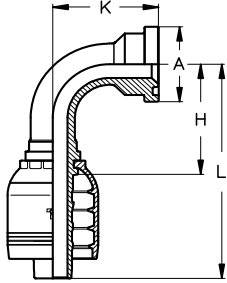
FL90
SAE CODE 61 FLANGE - 90° ELBOW
FLANGIA SAE CODE 61 - CURVA A 90°
SFL90

TIEFFE Part.N.	Hose Size			Flange Size Connection		Dimensions (mm)					Maximum W.P.	
	DN	Inch	Dash	Inch	Dash	H	L	K	A		bar	PSI
HSN1212FL90	19	3/4"	-12	3/4"	-12	55	106	51	38,1		350	5000
HSN1216FL90	19	3/4"	-12	1"	-16	55	106	55	44,5		350	5000
HSN1220FL90	19	3/4"	-12	1 1/4"	-20	55	106	60	50,8		280	4000
HSN1612FL90	25	1"	-16	3/4"	-12	71	128	65	38,1		350	5000
HSN1616FL90	25	1"	-16	1"	-16	71	128	61	44,5		350	5000
HSN1620FL90	25	1"	-16	1 1/4"	-20	71	128	61	50,8		280	4000
HSN1624FL90	25	1"	-16	1 1/2"	-24	71	128	61	60,4		210	3000
HSN2016FL90	31,5	1 1/4"	-20	1"	-16	87	154	79	44,5		350	5000
HSN2020FL90	31,5	1 1/4"	-20	1 1/4"	-20	87	154	71	50,8		280	4000
HSN2024FL90	31,5	1 1/4"	-20	1 1/2"	-24	87	154	71	60,4		210	3000
HSN2424FL90	38	1 1/2"	-24	1 1/2"	-24	105	188	83	60,4		210	3000
HSN2432FL90	38	1 1/2"	-24	2"	-32	105	188	81	71,4		210	3000
HSN3232FL90	51	2"	-32	2"	-32	140	237	122	71,4		210	3000
HSN3240FL90	51	2"	-32	2 1/2"	-40	140	237	117	84,1		175	2500

FL 90
 LONG DROP

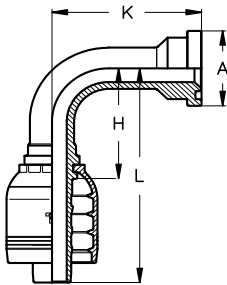
SAE CODE 61 FLANGE - 90° ELBOW - LONG DROP
FLANGIA SAE CODE 61 - CURVA A 90° - LUNGA
SFL90
 LONG DROP

TIEFFE Part.N.	Hose Size			Flange Size Connection		Dimensions (mm)					Maximum W.P.	
	DN	Inch	Dash	Inch	Dash	H	L	K	A		bar	PSI
HSN1212FL90-K96	19	3/4"	-12	3/4"	-12	55	106	96	38,1		350	5000
HSN1212FL90-K127	19	3/4"	-12	3/4"	-12	55	106	127	38,1		350	5000
HSN1216FL90-K79	19	3/4"	-12	1"	-16	55	106	79	44,5		350	5000
HSN1616FL90-K118	25	1"	-16	1"	-16	71	128	118	44,5		350	5000
HSN1620FL90-K118	25	1"	-16	1 1/4"	-20	71	128	118	50,8		280	4000
HSN2020FL90-K91	31,5	1 1/4"	-20	1 1/4"	-20	87	154	91	50,8		280	4000
HSN2020FL90-K102	31,5	1 1/4"	-20	1 1/4"	-20	87	154	102	50,8		280	4000
HSN2020FL90-K112	31,5	1 1/4"	-20	1 1/4"	-20	87	154	112	50,8		280	4000
HSN2020FL90-K130	31,5	1 1/4"	-20	1 1/4"	-20	87	154	130	50,8		280	4000
HSN2020FL90-K168	31,5	1 1/4"	-20	1 1/4"	-20	87	154	168	50,8		280	4000
HSN2024FL90-K118	31,5	1 1/4"	-20	1 1/2"	-24	87	154	118	60,4		210	3000
HSN2024FL90-K130	31,5	1 1/4"	-20	1 1/2"	-24	87	154	130	60,4		210	3000
HSN2424FL90-K148	38	1 1/2"	-24	1 1/2"	-24	105	188	148	60,4		210	3000
HSN2424FL90-K172	38	1 1/2"	-24	1 1/2"	-24	105	188	172	60,4		210	3000
HSN2432FL90-K115	38	1 1/2"	-24	2"	-32	105	188	115	71,4		210	3000
HSN2432FL90-K172	38	1 1/2"	-24	2"	-32	105	188	172	71,4		210	3000
HSN3232FL90-K165	51	2"	-32	2"	-32	140	237	165	71,4		210	3000
HSN3232FL90-K203	51	2"	-32	2"	-32	140	237	203	71,4		210	3000

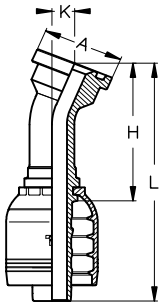
FL22
SAE CODE 61 FLANGE - 22,5° ELBOW
FLANGIA SAE CODE 61 - CURVA A 22,5°
SFL22,5

TIEFFE Part.N.	Hose Size			Flange Size Connection		Dimensions (mm)					Maximum W.P.	
	DN	Inch	Dash	Inch	Dash	H	L	K	A		bar	PSI
HSN1212FL22	19	3/4"	-12	3/4"	-12	70	121	11	38,1		350	5000
HSN1216FL22	19	3/4"	-12	1"	-16	73	124	12	44,5		350	5000
HSN1616FL22	25	1"	-16	1"	-16	86	142	12	44,5		350	5000
HSN1620FL22	25	1"	-16	1 1/4"	-20	86	142	12	50,8		280	4000
HSN2020FL22	31,5	1 1/4"	-20	1 1/4"	-20	100	166	13	50,8		280	4000
HSN2024FL22	31,5	1 1/4"	-20	1 1/2"	-24	100	166	13	60,4		210	3000
HSN2424FL22	38	1 1/2"	-24	1 1/2"	-24	118	201	15	60,4		210	3000
HSN2432FL22	38	1 1/2"	-24	2"	-32	116	199	14	71,4		210	3000
HSN3232FL22	51	2"	-32	2"	-32	165	262	22	71,4		210	3000

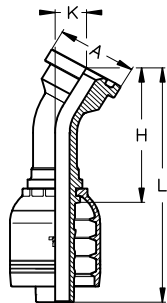
FL30
SAE CODE 61 FLANGE - 30° ELBOW
FLANGIA SAE CODE 61 - CURVA A 30°
SFL30

TIEFFE Part.N.	Hose Size			Flange Size Connection		Dimensions (mm)					Maximum W.P.	
	DN	Inch	Dash	Inch	Dash	H	L	K	A		bar	PSI
HSN1212FL30	19	3/4"	-12	3/4"	-12	68	119	16	38,1		350	5000
HSN1216FL30	19	3/4"	-12	1"	-16	71	122	17	44,5		350	5000
HSN1616FL30	25	1"	-16	1"	-16	84	140	17	44,5		350	5000
HSN1620FL30	25	1"	-16	1 1/4"	-20	84	140	17	50,8		280	4000
HSN2020FL30	31,5	1 1/4"	-20	1 1/4"	-20	98	164	19	50,8		280	4000
HSN2024FL30	31,5	1 1/4"	-20	1 1/2"	-24	98	164	19	60,4		210	3000
HSN2424FL30	38	1 1/2"	-24	1 1/2"	-24	116	199	22	60,4		210	3000
HSN2432FL30	38	1 1/2"	-24	2"	-32	114	197	21	71,4		210	3000
HSN3232FL30	51	2"	-32	2"	-32	162	258	31	71,4		210	3000

FL60
SAE CODE 61 FLANGE - 60° ELBOW
 FLANGIA SAE CODE 61 - CURVA A 60°

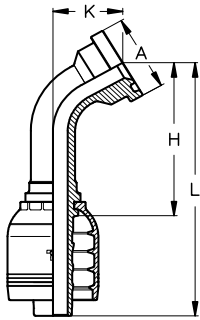
SFL60

TIEFFE Part.N.	Hose Size			Flange Size Connection		Dimensions (mm)					Maximum W.P.	
	DN	Inch	Dash	Inch	Dash	H	L	K	A		bar	PSI
HSN1212FL60	19	3/4"	-12	3/4"	-12	77	128	34	38,1		350	5000
HSN1216FL60	19	3/4"	-12	1"	-16	79	130	37	44,5		350	5000
HSN1616FL60	25	1"	-16	1"	-16	98	154	40	44,5		350	5000
HSN1620FL60	25	1"	-16	1 1/4"	-20	98	154	40	50,8		280	4000
HSN2020FL60	31,5	1 1/4"	-20	1 1/4"	-20	118	184	45	50,8		280	4000
HSN2024FL60	31,5	1 1/4"	-20	1 1/2"	-24	118	184	45	60,4		210	3000
HSN2424FL60	38	1 1/2"	-24	1 1/2"	-24	140	223	52	60,4		210	3000
HSN2432FL60	38	1 1/2"	-24	2"	-32	139	222	50	71,4		210	3000
HSN3232FL60	51	2"	-32	2"	-32	192	289	73	71,4		210	3000

FL67
SAE CODE 61 FLANGE - 67,5° ELBOW
 FLANGIA SAE CODE 61 - CURVA A 67,5°

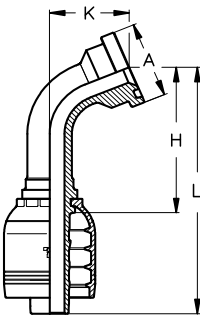
SFL67,5

TIEFFE Part.N.	Hose Size			Flange Size Connection		Dimensions (mm)					Maximum W.P.	
	DN	Inch	Dash	Inch	Dash	H	L	K	A		bar	PSI
HSN1212FL67	19	3/4"	-12	3/4"	-12	72	123	39	38,1		350	5000
HSN1216FL67	19	3/4"	-12	1"	-16	73	124	41	44,5		350	5000
HSN1616FL67	25	1"	-16	1"	-16	92	148	45	44,5		350	5000
HSN1620FL67	25	1"	-16	1 1/4"	-20	92	148	45	50,8		280	4000
HSN2020FL67	31,5	1 1/4"	-20	1 1/4"	-20	111	178	52	50,8		280	4000
HSN2024FL67	31,5	1 1/4"	-20	1 1/2"	-24	111	178	52	60,4		210	3000
HSN2424FL67	38	1 1/2"	-24	1 1/2"	-24	133	216	60	60,4		210	3000
HSN2432FL67	38	1 1/2"	-24	2"	-32	132	215	58	71,4		210	3000
HSN3232FL67	51	2"	-32	2"	-32	181	278	84	71,4		210	3000

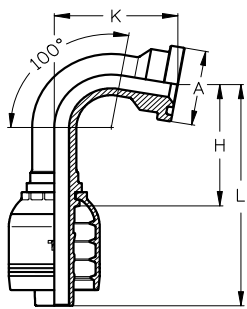
FL100
SAE CODE 61 FLANGE - 100° ELBOW
FLANGIA SAE CODE 61 - CURVA A 100°
SFL100

TIEFFE Part.N.	Hose Size			Flange Size Connection		Dimensions (mm)					Maximum W.P.	
	DN	Inch	Dash	Inch	Dash	H	L	K	A		bar	PSI
HSN1212FL100	19	3/4"	-12	3/4"	-12	61	112	59	38,1		350	5000
HSN1616FL100	25	1"	-16	1"	-16	77	134	68	44,5		350	5000

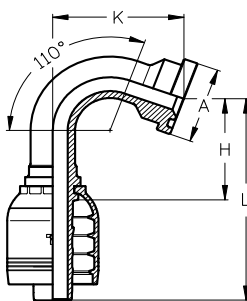
FL110
SAE CODE 61 FLANGE - 110° ELBOW
FLANGIA SAE CODE 61 - CURVA A 110°
SFL110

TIEFFE Part.N.	Hose Size			Flange Size Connection		Dimensions (mm)					Maximum W.P.	
	DN	Inch	Dash	Inch	Dash	H	L	K	A		bar	PSI
HSN1212FL110	19	3/4"	-12	3/4"	-12	51	102	62	38,1		350	5000
HSN1616FL110	25	1"	-16	1"	-16	65	121	73	44,5		350	5000
HSN1620FL110	25	1"	-16	1 1/4"	-20	65	121	73	50,8		280	4000
HSN2020FL110	31,5	1 1/4"	-20	1 1/4"	-20	82	148	83	50,8		280	4000
HSN2024FL110	31,5	1 1/4"	-20	1 1/2"	-24	82	148	83	60,4		210	3000
HSN2424FL110	38	1 1/2"	-24	1 1/2"	-24	95	178	97	60,4		210	3000
HSN3232FL110	51	2"	-32	2"	-32	124	220	142	71,4		210	3000

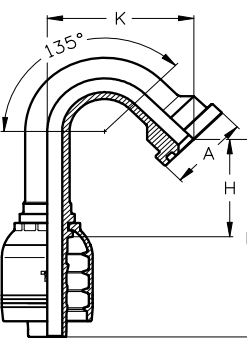
FL135
SAE CODE 61 FLANGE - 135° ELBOW
FLANGIA SAE CODE 61 - CURVA A 135°
SFL135

TIEFFE Part.N.	Hose Size			Flange Size Connection		Dimensions (mm)					Maximum W.P.	
	DN	Inch	Dash	Inch	Dash	H	L	K	A		bar	PSI
HSN1212FL135	19	3/4"	-12	3/4"	-12	69	120	70	38,1		350	5000
HSN1216FL135	19	3/4"	-12	1"	-16	69	120	70	44,5		350	5000
HSN1616FL135	25	1"	-16	1"	-16	57	113	86	44,5		350	5000

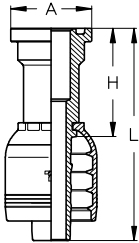
FP
SAE CODE 62 FLANGE
FLANGIA SAE CODE 62
SFS

TIEFFE Part.N.	Hose Size			Flange Size Connection		Dimensions (mm)					Maximum W.P.	
	DN	Inch	Dash	Inch	Dash	H	L	A			bar	PSI
HSN1212FP	19	3/4"	-12	3/4"	-12	59	110	41,3			420	6000
HSN1216FP	19	3/4"	-12	1"	-16	61	112	47,6			420	600
HSN1612FP	25	1"	-16	3/4"	-12	65	121,5	41,3			415	600
HSN1616FP	25	1"	-16	1"	-16	65	121,5	47,6			415	600
HSN1620FP	25	1"	-16	1 1/4"	-20	69	125,5	54			415	600
HSN2016FP	31,5	1 1/4"	-20	1"	-16	70	136,5	47,6			325	4700
HSN2020FP	31,5	1 1/4"	-20	1 1/4"	-20	70	136,5	54			325	4700
HSN2024FP	31,5	1 1/4"	-20	1 1/2"	-24	80	146,5	63,5			325	4700
HSN2424FP	38	1 1/2"	-24	1 1/2"	-24	84	116,5	63,5			290	4200
HSN2432FP	38	1 1/2"	-24	2"	-32	99	181,5	79,4			290	4200
HSN3232FP	51	2"	-32	2"	-32	100	196,5	79,4			250	3600

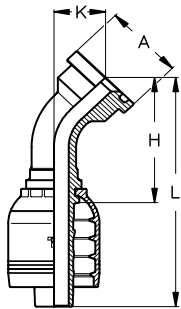
FP45
SAE CODE 62 FLANGE - 45° ELBOW
FLANGIA SAE CODE 62 - CURVA A 45°
SFS45

TIEFFE Part.N.	Hose Size			Flange Size Connection		Dimensions (mm)					Maximum W.P.		
	DN	Inch	Dash	Inch	Dash	H	L	K	A			bar	PSI
HSN1212FP45	19	3/4"	-12	3/4"	-12	66	117	28	41,3			420	6000
HSN1216FP45	19	3/4"	-12	1"	-16	68	118	29	47,6			420	600
HSN1612FP45	25	1"	-16	3/4"	-12	81	137	31	41,3			415	600
HSN1616FP45	25	1"	-16	1"	-16	80	136	30	47,6			415	600
HSN1620FP45	25	1"	-16	1 1/4"	-20	80	136	30	54			415	600
HSN2016FP45	31,5	1 1/4"	-20	1"	-16	96	163	37	47,6			325	4700
HSN2020FP45	31,5	1 1/4"	-20	1 1/4"	-20	93	160	34	54			325	4700
HSN2024FP45	31,5	1 1/4"	-20	1 1/2"	-24	94	161	35	63,5			325	4700
HSN2424FP45	38	1 1/2"	-24	1 1/2"	-24	112	195	40	63,5			290	4200
HSN2432FP45	38	1 1/2"	-24	2"	-32	115	198	43	79,4			290	4200
HSN3232FP45	51	2"	-32	2"	-32	150	247	56	79,4			250	3600

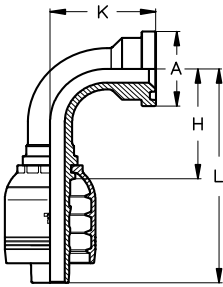
FP90
SAE CODE 62 FLANGE - 90° ELBOW
FLANGIA SAE CODE 62 - CURVA A 90°
SFS90

TIEFFE Part.N.	Hose Size			Flange Size Connection		Dimensions (mm)					Maximum W.P.	
	DN	Inch	Dash	Inch	Dash	H	L	K	A		bar	PSI
HSN1212FP90	19	3/4"	-12	3/4"	-12	55	106	56	41,3		420	6000
HSN1216FP90	19	3/4"	-12	1"	-16	55	106	58	47,6		420	600
HSN1612FP90	25	1"	-16	3/4"	-12	71	128	65	41,3		415	600
HSN1616FP90	25	1"	-16	1"	-16	71	128	64	47,6		415	600
HSN1620FP90	25	1"	-16	1 1/4"	-20	71	128	64	54		415	600
HSN2016FP90	31,5	1 1/4"	-20	1"	-16	87	154	79	47,6		325	4700
HSN2020FP90	31,5	1 1/4"	-20	1 1/4"	-20	87	154	74	54		325	4700
HSN2024FP90	31,5	1 1/4"	-20	1 1/2"	-24	87	154	76	63,5		325	4700
HSN2424FP90	38	1 1/2"	-24	1 1/2"	-24	105	188	88	63,5		290	4200
HSN2432FP90	38	1 1/2"	-24	2"	-32	105	188	93	79,4		290	4200
HSN3232FP90	51	2"	-32	2"	-32	140	237	123	79,4		250	3600

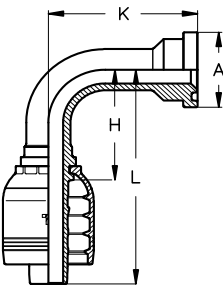
FP90
LONG DROP
SAE CODE 62 FLANGE - 90° ELBOW - LONG DROP
FLANGIA SAE CODE 62 - CURVA A 90° - LUNGA
SFS90
LONG DROP

TIEFFE Part.N.	Hose Size			Flange Size Connection		Dimensions (mm)					Maximum W.P.	
	DN	Inch	Dash	Inch	Dash	H	L	K	A		bar	PSI
HSN1212FP90-K100	19	3/4"	-12	3/4"	-12	55	106	100	41,3		420	6000
HSN1216FP90-K140	19	3/4"	-12	1"	-16	55	106	140	47,6		420	6000
HSN1616FP90-K120	25	1"	-16	1"	-16	71	128	120	47,6		415	6000
HSN2020FP90-K120	31,5	1 1/4"	-20	1 1/4"	-20	87	154	120	54		325	4700

FP22
SAE CODE 62 FLANGE - 22,5° ELBOW
 FLANGIA SAE CODE 62 - CURVA A 22,5°

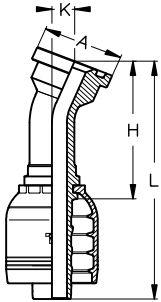
SFS22,5

TIEFFE Part.N.	Hose Size			Flange Size Connection		Dimensions (mm)					Maximum W.P.	
	DN	Inch	Dash	Inch	Dash	H	L	K	A		bar	PSI
HSN1212FP22	19	3/4"	-12	3/4"	-12	74	125	13	41,3		420	6000
HSN1216FP22	19	3/4"	-12	1"	-16	76	127	14	47,6		420	6000
HSN1616FP22	25	1"	-16	1"	-16	89	145	13	47,6		415	6000
HSN1620FP22	25	1"	-16	1 1/4"	-20	89	145	13	54		415	6000
HSN2020FP22	31,5	1 1/4"	-20	1 1/4"	-20	103	169	15	54		325	4700
HSN2024FP22	31,5	1 1/4"	-20	1 1/2"	-24	104	171	15	63,5		325	4700
HSN2424FP22	38	1 1/2"	-24	1 1/2"	-24	123	206	17	63,5		290	4200
HSN2432FP22	38	1 1/2"	-24	2"	-32	127	210	19	79,4		290	4200
HSN3232FP22	51	2"	-32	2"	-32	166	263	24	79,4		250	3600

FP30
SAE CODE 62 FLANGE - 30° ELBOW
 FLANGIA SAE CODE 62 - CURVA A 30°

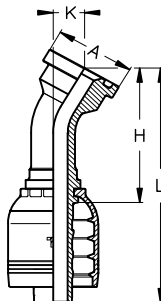
SFS30

TIEFFE Part.N.	Hose Size			Flange Size Connection		Dimensions (mm)					Maximum W.P.	
	DN	Inch	Dash	Inch	Dash	H	L	K	A		bar	PSI
HSN1212FP30	19	3/4"	-12	3/4"	-12	72	123	18	41,3		420	6000
HSN1216FP30	19	3/4"	-12	1"	-16	74	125	19	47,6		420	6000
HSN1616FP30	25	1"	-16	1"	-16	87	143	19	47,6		415	6000
HSN1620FP30	25	1"	-16	1 1/4"	-20	87	143	19	54		415	6000
HSN2020FP30	31,5	1 1/4"	-20	1 1/4"	-20	100	167	20	54		325	4700
HSN2024FP30	31,5	1 1/4"	-20	1 1/2"	-24	102	168	21	63,5		325	4700
HSN2424FP30	38	1 1/2"	-24	1 1/2"	-24	121	203	24	63,5		290	4200
HSN2432FP30	38	1 1/2"	-24	2"	-32	124	207	26	79,4		290	4200
HSN3232FP30	51	2"	-32	2"	-32	162	259	34	79,4		250	3600

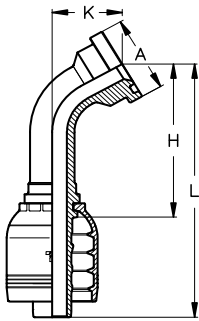
FP60

SAE CODE 62 FLANGE - 60° ELBOW
FLANGIA SAE CODE 62 - CURVA A 60°
SFS60

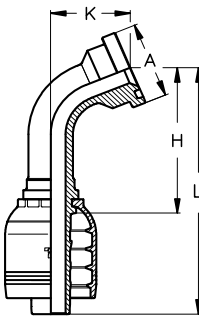
TIEFFE Part.N.	Hose Size			Flange Size Connection		Dimensions (mm)					Maximum W.P.	
	DN	Inch	Dash	Inch	Dash	H	L	K	A		bar	PSI
HSN1212FP60	19	3/4"	-12	3/4"	-12	79	130	38	41,3		420	6000
HSN1216FP60	19	3/4"	-12	1"	-16	80	131	40	47,6		420	6000
HSN1616FP60	25	1"	-16	1"	-16	99	155	42	47,6		415	6000
HSN1620FP60	25	1"	-16	1 1/4"	-20	99	155	42	54		415	6000
HSN2020FP60	31,5	1 1/4"	-20	1 1/4"	-20	119	185	47	54		325	4700
HSN2024FP60	31,5	1 1/4"	-20	1 1/2"	-24	120	186	49	63,5		325	4700
HSN2424FP60	38	1 1/2"	-24	1 1/2"	-24	143	225	56	63,5		290	4200
HSN2432FP60	38	1 1/2"	-24	2"	-32	145	228	60	79,4		290	4200
HSN3232FP60	51	2"	-32	2"	-32	193	289	79	79,4		250	3600

FP67

SAE CODE 62 FLANGE - 67,5° ELBOW
FLANGIA SAE CODE 62 - CURVA A 67,5°
SFS67,5

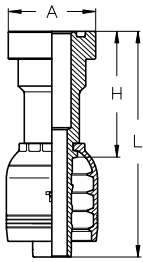
TIEFFE Part.N.	Hose Size			Flange Size Connection		Dimensions (mm)					Maximum W.P.	
	DN	Inch	Dash	Inch	Dash	H	L	K	A		bar	PSI
HSN1212FP67	19	3/4"	-12	3/4"	-12	74	125	43	41,3		420	6000
HSN1216FP67	19	3/4"	-12	1"	-16	75	126	45	47,6		420	6000
HSN1616FP67	25	1"	-16	1"	-16	93	150	48	47,6		415	6000
HSN1620FP67	25	1"	-16	1 1/4"	-20	93	150	48	54		415	6000
HSN2020FP67	31,5	1 1/4"	-20	1 1/4"	-20	112	179	54	54		325	4700
HSN2024FP67	31,5	1 1/4"	-20	1 1/2"	-24	113	180	56	63,5		325	4700
HSN2424FP67	38	1 1/2"	-24	1 1/2"	-24	135	217	65	63,5		290	4200
HSN2432FP67	38	1 1/2"	-24	2"	-32	137	219	69	79,4		290	4200
HSN3232FP67	51	2"	-32	2"	-32	182	278	90	79,4		250	3600

YP
"SUPERCAT" FLANGE
FLANGIA "SUPERCAT"

SFS
SUPERCAT

TIEFFE Part.N.	Hose Size			Flange Size Connection		Dimensions (mm)					Maximum W.P.	
	DN	Inch	Dash	Inch	Dash	H	L	A			bar	PSI
HSN1212YP	19	3/4"	-12	3/4"	-12	84	135	41,3			420	6000
HSN1216YP	19	3/4"	-12	1"	-16	84	135	47,6			420	6000
HSN1616YP	25	1"	-16	1"	-16	90	146,5	47,6			415	6000
HSN1620YP	25	1"	-16	1 1/4"	-20	90	146,5	54			415	6000
HSN2020YP	31,5	1 1/4"	-20	1 1/4"	-20	88	154,4	54			325	4700
HSN2024YP	31,5	1 1/4"	-20	1 1/2"	-24	88	154,5	63,5			325	4700
HSN2424YP	38	1 1/2"	-24	1 1/2"	-24	84	166,5	63,5			290	4200
HSN2432YP	38	1 1/2"	-24	2"	-32	110	192,5	79,4			290	4200
HSN3232YP	51	2"	-32	2"	-32	130	226,5	79,4			250	3600

YP45
"SUPERCAT" FLANGE - 45° ELBOW
FLANGIA "SUPERCAT" - CURVA A 45°

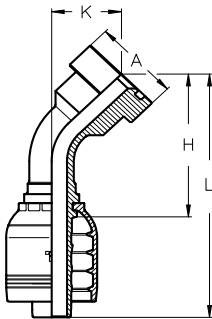
SFS45
SUPERCAT

TIEFFE Part.N.	Hose Size			Flange Size Connection		Dimensions (mm)					Maximum W.P.	
	DN	Inch	Dash	Inch	Dash	H	L	K	A		bar	PSI
HSN1212YP45	19	3/4"	-12	3/4"	-12	72	123	34	41,3		420	6000
HSN1216YP45	19	3/4"	-12	1"	-16	74	125	36	47,6		420	6000
HSN1616YP45	25	1"	-16	1"	-16	86	143	36	47,6		415	6000
HSN1620YP45	25	1"	-16	1 1/4"	-20	86	143	36	54		415	6000
HSN2020YP45	31,5	1 1/4"	-20	1 1/4"	-20	96	162	36	54		325	4700
HSN2024YP45	31,5	1 1/4"	-20	1 1/2"	-24	96	162	36	63,5		325	4700
HSN2424YP45	38	1 1/2"	-24	1 1/2"	-24	114	196	41	63,5		290	4200
HSN2432YP45	38	1 1/2"	-24	2"	-32	116	199	44	79,4		290	4200
HSN3232YP45	51	2"	-32	2"	-32	152	250	57	79,4		250	3600

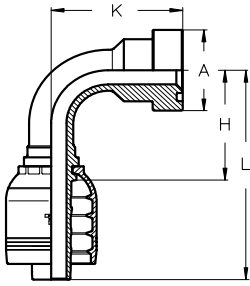
YP90
"SUPERCAT" FLANGE - 90° ELBOW
FLANGIA "SUPERCAT" - CURVA A 90°
SFS90
SUPERCAT

TIEFFE Part.N.	Hose Size			Flange Size Connection		Dimensions (mm)					Maximum W.P.	
	DN	Inch	Dash	Inch	Dash	H	L	K	A		bar	PSI
HSN1212YP90	19	3/4"	-12	3/4"	-12	55	106	64	41,3		420	6000
HSN1216YP90	19	3/4"	-12	1"	-16	55	106	64	47,6		420	6000
HSN1616YP90	25	1"	-16	1"	-16	71	128	73	47,6		415	6000
HSN1620YP90	25	1"	-16	1 1/4"	-20	71	128	73	54		415	6000
HSN2020YP90	31,5	1 1/4"	-20	1 1/4"	-20	87	154	77	54		325	4700
HSN2024YP90	31,5	1 1/4"	-20	1 1/2"	-24	87	154	78	63,5		325	4700
HSN2424YP90	38	1 1/2"	-24	1 1/2"	-24	105	188	90	63,5		290	4200
HSN2432YP90	38	1 1/2"	-24	2"	-32	105	188	94	79,4		290	4200
HSN3232YP90	51	2"	-32	2"	-32	140	237	125	79,4		250	3600

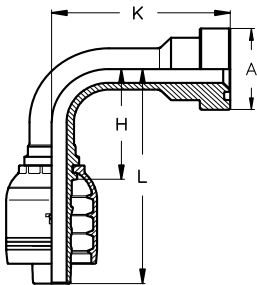
YP90
LONG DROP
"SUPERCAT" FLANGE - 90° ELBOW - LONG DROP
FLANGIA "SUPERCAT" - CURVA A 90° - LUNGA
SFS90
*SUPERCAT
LONG DROP*

TIEFFE Part.N.	Hose Size			Flange Size Connection		Dimensions (mm)					Maximum W.P.	
	DN	Inch	Dash	Inch	Dash	H	L	K	A		bar	PSI
HSN1212YP90-K129	19	3/4"	-12	3/4"	-12	55	106	129	41,3		420	6000
HSN1616YP90-K132	25	1"	-16	1"	-16	71	128	132	47,6		415	6000
HSN1616YP90-K150	25	1"	-16	1"	-16	71	128	150	47,6		415	6000
HSN2020YP90-K150	31,5	1 1/4"	-20	1 1/4"	-20	87	154	150	54		325	4700
HSN2024YP90-K135	31,5	1 1/4"	-20	1 1/2"	-24	87	154	135	63,5		325	4700
HSN2424YP90-K106	38	1 1/2"	24	1 1/2"	-24	105	188	106	63,5		290	4200

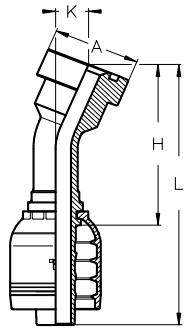
YP22

"SUPERCAT" FLANGE - 22,5° ELBOW
 FLANGIA "SUPERCAT" - CURVA A 22,5°

SFS22,5
 SUPERCAT

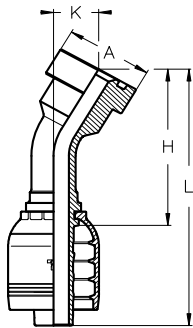
TIEFFE Part.N.	Hose Size			Flange Size Connection		Dimensions (mm)					Maximum W.P.	
	DN	Inch	Dash	Inch	Dash	H	L	K	A		bar	PSI
HSN1212YP22	19	3/4"	-12	3/4"	-12	82	133	16	41,3		420	6000
HSN1216YP22	19	3/4"	-12	1"	-16	84	135	17	47,6		420	6000
HSN1616YP22	25	1"	-16	1"	-16	97	153	17	47,6		415	6000
HSN1620YP22	25	1"	-16	1 1/4"	-20	97	153	17	54		415	6000
HSN2020YP22	31,5	1 1/4"	-20	1 1/4"	-20	406	172	16	54		325	4700
HSN2024YP22	31,5	1 1/4"	-20	1 1/2"	-24	406	174	16	63,5		325	4700
HSN2424YP22	38	1 1/2"	-24	1 1/2"	-24	125	208	18	63,5		290	4200
HSN2432YP22	38	1 1/2"	-24	2"	-32	129	211	19	79,4		290	4200
HSN3232YP22	51	2"	-32	2"	-32	168	265	25	79,4		250	3600

YP30

"SUPERCAT" FLANGE - 30° ELBOW
 FLANGIA "SUPERCAT" - CURVA A 30°

SFS30
 SUPERCAT

TIEFFE Part.N.	Hose Size			Flange Size Connection		Dimensions (mm)					Maximum W.P.	
	DN	Inch	Dash	Inch	Dash	H	L	K	A		bar	PSI
HSN1212YP30	19	3/4"	-12	3/4"	-12	79	130	22	41,3		420	6000
HSN1216YP30	19	3/4"	-12	1"	-16	82	133	23	47,6		420	6000
HSN1616YP30	25	1"	-16	1"	-16	94	151	23	47,6		415	6000
HSN1620YP30	25	1"	-16	1 1/4"	-20	94	151	23	54		415	6000
HSN2020YP30	31,5	1 1/4"	-20	1 1/4"	-20	103	170	22	54		325	4700
HSN2024YP30	31,5	1 1/4"	-20	1 1/2"	-24	104	170	23	63,5		325	4700
HSN2424YP30	38	1 1/2"	-24	1 1/2"	-24	123	205	25	63,5		290	4200
HSN2432YP30	38	1 1/2"	-24	2"	-32	126	208	27	79,4		290	4200
HSN3232YP30	51	2"	-32	2"	-32	164	264	35	79,4		250	3600

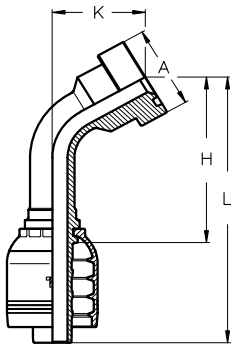
YP60
"SUPERCAT" FLANGE - 60° ELBOW
 FLANGIA "SUPERCAT" - CURVA A 60°

SFS60
 SUPERCAT

TIEFFE Part.N.	Hose Size			Flange Size Connection		Dimensions (mm)					Maximum W.P.	
	DN	Inch	Dash	Inch	Dash	H	L	K	A		bar	PSI
HSN1212YP60	19	3/4"	-12	3/4"	-12	83	134	45	41,3		420	6000
HSN1216YP60	19	3/4"	-12	1"	-16	85	136	48	47,6		420	6000
HSN1616YP60	25	1"	-16	1"	-16	103	160	50	47,6		415	6000
HSN1620YP60	25	1"	-16	1 1/4"	-20	103	160	50	54		415	6000
HSN2020YP60	31,5	1 1/4"	-20	1 1/4"	-20	121	187	50	54		325	4700
HSN2024YP60	31,5	1 1/4"	-20	1 1/2"	-24	121	187	51	63,5		325	4700
HSN2424YP60	38	1 1/2"	-24	1 1/2"	-24	144	226	58	63,5		290	4200
HSN2432YP60	38	1 1/2"	-24	2"	-32	146	228	61	79,4		290	4200
HSN3232YP60	51	2"	-32	2"	-32	194	290	81	79,4		250	3600

YP67
"SUPERCAT" FLANGE - 67,5° ELBOW
 FLANGIA "SUPERCAT" - CURVA A 67,5°

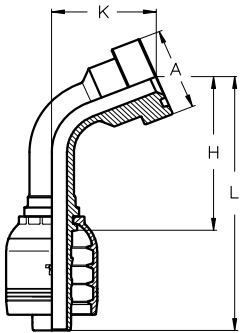
SFS67,5
 SUPERCAT

TIEFFE Part.N.	Hose Size			Flange Size Connection		Dimensions (mm)					Maximum W.P.	
	DN	Inch	Dash	Inch	Dash	H	L	K	A		bar	PSI
HSN1212YP67	19	3/4"	-12	3/4"	-12	77	128	50	41,3		420	6000
HSN1216YP67	19	3/4"	-12	1"	-16	79	130	53	47,6		420	6000
HSN1616YP67	25	1"	-16	1"	-16	97	153	56	47,6		415	6000
HSN1620YP67	25	1"	-16	1 1/4"	-20	97	153	56	54		415	6000
HSN2020YP67	31,5	1 1/4"	-20	1 1/4"	-20	114	181	57	54		325	4700
HSN2024YP67	31,5	1 1/4"	-20	1 1/2"	-24	114	181	58	63,5		325	4700
HSN2424YP67	38	1 1/2"	-24	1 1/2"	-24	137	219	66	63,5		290	4200
HSN2432YP67	38	1 1/2"	-24	2"	-32	138	220	69	79,4		290	4200
HSN3232YP67	51	2"	-32	2"	-32	184	280	92	79,4		250	3600

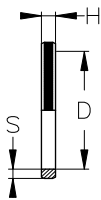
D'RING SEAL FOR "SUPERCAT" FLANGES
 GUARNIZIONI D'RING PER FLANGE "SUPERCAT"

TIEFFE Part.N.	Flange Connection		Dimensions (mm)		
	Inch	Dash	D	H	S
DR12	3/4"	-12	25,4	5	3,5
DR16	1"	-16	31,8	5	3,5
DR20	1 1/4"	-20	38,1	5	3,5
DR24	1 1/2"	-24	44,5	5	3,5
DR32	2"	-32	63,9	5	3,5

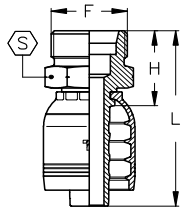
MM-S
METRIC MALE - 24° CONE SEAT - HEAVY DUTY
MASCHIO METRICO - SVASATO 24° - SERIE PESANTE
CES

TIEFFE Part.N.	Hose Size			METRIC 24° Connection		Dimensions (mm)					Maximum W.P.	
	DN	Inch	Dash	F	Pipe	H	L	S			bar	PSI
HSN12MM20S	19	3/4"	-12	M30x2	20S	34	85	30			420	6000
HSN12MM25S	19	3/4"	-12	M36x2	25S	38	89	36			420	6000
HSN16MM25S	25	1"	-16	M36x2	25S	40	97	36			380	5500
HSN16MM30S	25	1"	-16	M42x2	30S	44	101	46			380	5500
HSN20MM30S	31,5	1 1/4"	-20	M42x2	30S	47	113	46			325	4700
HSN20MM38S	31,5	1 1/4"	-24	M52x2	38S	51	117	55			325	4700
HSN24MM38S	38	1 1/2"	-24	M52x2	38S	53	135	55			290	4200

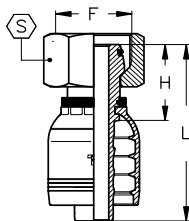
FOS-S
METRIC FEMALE 24° O'RING CONE - HEAVY DUTY - SLIP-ON NUT
FEMMINA METRICA OGIVA 24° O'RING - SERIE PESANTE - DADO LIBERO
DKOS

TIEFFE Part.N.	Hose Size			METRIC 24° Connection		Dimensions (mm)					Maximum W.P.	
	DN	Inch	Dash	F	Pipe	H	L	S		O-RING	bar	PSI
HSN12FOS20S	19	3/4"	-12	M30x2	20S	37	88	36		16,3x2,4	420	6000
HSN12FOS25S	19	3/4"	-12	M36x2	25S	39	90	46		20,3x2,4	420	6000
HSN16FOS25S	25	1"	-16	M36x2	25S	41	97	46		22x2	380	5500
HSN16FOS30S	25	1"	-16	M42x2	30S	42	98	50		25,3x2,4	380	5500
HSN20FOS30S	31,5	1 1/4"	-20	M42x2	30S	43	109	50		25,3x2,4	325	4700
HSN20FOS38S	31,5	1 1/4"	-20	M52x2	38S	48	115	60		33,3x2,4	325	4700
HSN24FOS38S	38	1 1/2"	-24	M52x2	38S	51	133	60		33,3x2,4	290	4200

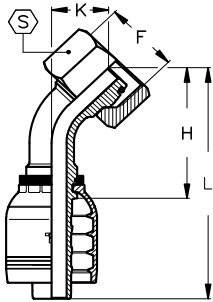
FOS-S45
METRIC FEMALE 24° O'RING CONE - 45° ELBOW - HEAVY DUTY - SLIP-ON NUT
FEMMINA METRICA OGIVA 24° O'RING - CURVA A 45° - SERIE PESANTE - DADO LIBERO
DKOS45

TIEFFE Part.N.	Hose Size			METRIC 24° Connection		Dimensions (mm)					Maximum W.P.	
	DN	Inch	Dash	F	Pipe	H	L	K	S	O-RING	bar	PSI
HSN12FOS20S45	19	3/4"	-12	M30x2	20S	65	116	27	36	16,3x2,4	420	6000
HSN12FOS25S45	19	3/4"	-12	M36x2	25S	66	117	28	46	20,3x2,4	420	6000
HSN16FOS25S45	25	1"	-16	M36x2	25S	83	140	34	46	22x2	380	5500
HSN16FOS30S45	25	1"	-16	M42x2	30S	82	138	32	50	25,3x2,4	380	5500
HSN20FOS30S45	31,5	1 1/4"	-20	M42x2	30S	100	166	40	50	25,3x2,4	325	4700
HSN20FOS38S45	31,5	1 1/4"	-20	M52x2	38S	97	164	38	60	33,3x2,4	325	4700
HSN24FOS38S45	38	1 1/2"	-24	M52x2	38S	121	203	48	60	33,3x2,4	290	4200

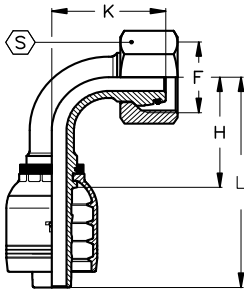
FOS-S90
METRIC FEMALE 24° O'RING CONE - 90° ELBOW - HEAVY DUTY - SLIP-ON NUT
FEMMINA METRICA OGIVA 24° O'RING - CURVA A 90° - SERIE PESANTE - DADO LIBERO
DKOS90

TIEFFE Part.N.	Hose Size			METRIC 24° Connection		Dimensions (mm)					Maximum W.P.	
	DN	Inch	Dash	F	Pipe	H	L	K	S	O-RING	bar	PSI
HSN12FOS20S90	19	3/4"	-12	M30x2	20S	55	106	55	36	16,3x2,4	420	6000
HSN12FOS25S90	19	3/4"	-12	M36x2	25S	55	106	55	46	20,3x2,4	420	6000
HSN16FOS25S90	25	1"	-16	M36x2	25S	71	128	69	46	22x2	380	5500
HSN16FOS30S90	25	1"	-16	M42x2	30S	71	128	67	50	25,3x2,4	380	5500
HSN20FOS30S90	31,5	1 1/4"	-20	M42x2	30S	87	154	83	50	25,3x2,4	325	4700
HSN20FOS38S90	31,5	1 1/4"	-20	M52x2	38S	87	154	80	60	33,3x2,4	325	4700
HSN24FOS38S90	38	1 1/2"	-24	M52x2	38S	105	188	100	60	33,3x2,4	290	4200

NO-SKIVE

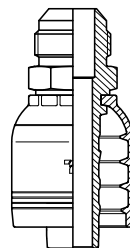



HSN

NO-SKIVE



RUBBER HOSES STEEL WIRE SPIRAL - TUBI GOMMA SPIRALATI ACCIAIO

Hose Size			ISO 3862 4SP			ISO 3862 4SH			ISO 3862 R12 SAE100 R12			ISO 3862 R13 SAE100 R13			ISO 3862 R15 SAE100 R15			Collapse control mandrel Spina controllo collasso			
			"HSN" Fitting Raccordo "HSN"	Skiving length Lungh. di pelatura	Ø Swage (Ref.) Ø Press. (Rif.)	"HSN" Fitting Raccordo "HSN"	Skiving length Lungh. di pelatura	Ø Swage (Ref.) Ø Press. (Rif.)	"HSN" Fitting Raccordo "HSN"	Skiving length Lungh. di pelatura	Ø Swage (Ref.) Ø Press. (Rif.)	"HSN" Fitting Raccordo "HSN"	Skiving length Lungh. di pelatura	Ø Swage (Ref.) Ø Press. (Rif.)	"HSN" Fitting Raccordo "HSN"	Skiving length Lungh. di pelatura	Ø Swage (Ref.) Ø Press. (Rif.)				
DN	Inch	Dash	Part.N.	mm	mm	Part.N.	mm	mm	Part.N.	mm	mm	Part.N.	mm	mm	Part.N.	mm	mm	Part.N.	mm	mm	Part.N.
19	3/4"	-12	HSN12	no-skive	35,8	HSN12	no-skive	35,8	HSN12	no-skive	34,5	HSN12	no-skive	35,7	HSN12	no-skive	35,7				SCS12
25	1"	-16	HSN16	no-skive	42,9	HSN16	no-skive	42	HSN16	no-skive	41,4	HSN16	no-skive	42	HSN16	no-skive	42				SCS16
31,5	1 1/4"	-20				HSN20	no-skive	50,5	HSN20	no-skive	51,8										SCS20
38	1 1/2"	-24				HSN24	no-skive	59,8	HSN24	no-skive	59,8										SCS24
51	2"	-32				HSN32	no-skive	73,5	HSN32	no-skive	73,5										SCS32

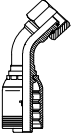
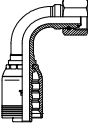
BRITISH STANDARD CONNECTIONS

REFERENCE	DESCRIPTION	PAGE	REFERENCE	DESCRIPTION	PAGE
HSS-MGC	 <p>BSP TAPERED MALE 60° CONE SEAT MASCHIO GAS CONICO SVASATO 60°</p>	213	HSS-FGO	 <p>BSP FEMALE 60° O-RING CONE TIEFFE NUT BS 5200 - ISO 12151-6 FEMMINA GAS OGIVA 60° O-RING DADO TIEFFE BS 5200 - ISO 12151-6</p>	214
HSS-MG	 <p>BSP PARALLEL MALE 60° CONE SEAT BS 5200 - ISO 12151-6 MASCHIO GAS CILINDRICO SVASATO 60° BS 5200 - ISO 12151-6</p>	213	HSS-FGO45	 <p>BSP FEMALE 60° O RING CONE 45° ELBOW - TIEFFE NUT BS 5200 - ISO 12151-6 FEMMINA GAS OGIVA 60° O-RING CURVA A 45° - DADO TIEFFE BS 5200 - ISO 12151-6</p>	214
			HSS-FGO90	 <p>BSP FEMALE 60° O RING CONE 90° ELBOW - TIEFFE NUT BS 5200 - ISO 12151-6 FEMMINA GAS OGIVA 60° O-RING CURVA A 90° - DADO TIEFFE BS 5200 - ISO 12151-6</p>	214

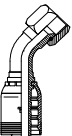
AMERICAN STANDARD CONNECTIONS - NPTF - JIC 37°

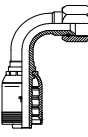
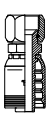
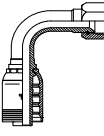
REFERENCE	DESCRIPTION	PAGE	REFERENCE	DESCRIPTION	PAGE
HSS-NPT	 <p>NPTF MALE 60° CONE SEAT SAE J516 MASCHIO NPTF SVASATO 60° SAE J516</p>	215	HSS-FIS45	 <p>JIC FEMALE 37° CONE SEAT 45° ELBOW - TIEFFE NUT SAE J516 - ISO 12151-5 FEMMINA JIC SVASATA 37° CURVA A 45° - DADO TIEFFE SAE J516 - ISO 12151-5</p>	216
HSS-MI	 <p>JIC MALE 37° CONE SAE J516 - ISO 12151-5 MASCHIO JIC CONO 37° SAE J516 - ISO 12151-5</p>	215	HSS-FIS90	 <p>JIC FEMALE 37° CONE SEAT 90° ELBOW - TIEFFE NUT SAE J516 - ISO 12151-5 FEMMINA JIC SVASATA 37° CURVA A 90° - DADO TIEFFE SAE J516 - ISO 12151-5</p>	216
HSS-FIC	 <p>JIC FEMALE 37° CONE SEAT DOUBLE EXAGON - TIEFFE NUT SAE J516 - ISO 12151-5 FEMMINA JIC SVASATA 37° DOPPIO ESAGONO - DADO TIEFFE SAE J516 - ISO 12151-5</p>	215	HSS-FIS90-K-	 <p>JIC FEMALE 37° CONE SEAT 90° ELBOW - LONG DROP - TIEFFE NUT SAE J516 - ISO 12151-5 FEMMINA JIC SVASATA 37° CURVA A 90° - LUNGA - DADO TIEFFE SAE J516 - ISO 12151-5</p>	216

AMERICAN STANDARD CONNECTIONS - ORFS (SAE J516 / ISO 12151-1)

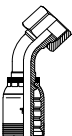
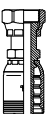
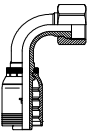
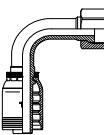
REFERENCE	DESCRIPTION	PAGE	REFERENCE	DESCRIPTION	PAGE
HSS-MRS	 <p>ORFS MALE MASCHIO ORFS</p>	217	HSS-FRS45	 <p>ORFS FEMALE 45° ELBOW - SLIP-ON NUT FEMMINA ORFS CURVA A 45° - DADO LIBERO</p>	218
HSS-FRC	 <p>ORFS FEMALE DOUBLE EXAGON - CRIMPED-BACK NUT FEMMINA ORFS DOPPIO ESAGONO - DADO PRESSATO</p>	217	HSS-FRS90	 <p>ORFS FEMALE 90° ELBOW - SHORT DROP SLIP-ON NUT FEMMINA ORFS CURVA A 90° - CORTA DADO LIBERO</p>	218
			HSS-FRS90-K-	 <p>ORFS FEMALE 90° ELBOW - LONG DROP SLIP-ON NUT FEMMINA ORFS CURVA A 90° - LUNGA DADO LIBERO</p>	218

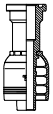
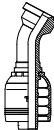
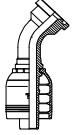
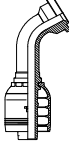
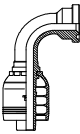
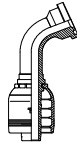
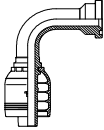
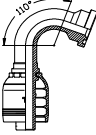
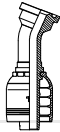

AMERICAN STANDARD CONNECTIONS - FLANGE CODE 61 (SAE J516 / ISO 12151-3)

REFERENCE	DESCRIPTION	PAGE	REFERENCE	DESCRIPTION	PAGE
HSS-FL	 SAE CODE 61 FLANGE FLANGIA SAE CODE 61	219	HSS-FL30	 SAE CODE 61 FLANGE 30° ELBOW FLANGIA SAE CODE 61 CURVA A 30°	221
HSS-FL45	 SAE CODE 61 FLANGE 45° ELBOW FLANGIA SAE CODE 61 CURVA A 45°	219	HSS-FL60	 SAE CODE 61 FLANGE 60° ELBOW FLANGIA SAE CODE 61 CURVA A 60°	222
HSS-FL90	 SAE CODE 61 FLANGE 90° ELBOW FLANGIA SAE CODE 61 CURVA A 90°	220	HSS-FL67	 SAE CODE 61 FLANGE 67,5° ELBOW FLANGIA SAE CODE 61 CURVA A 67,5°	222
HSS-FL90-K-	 SAE CODE 61 FLANGE 90° ELBOW - LONG DROP FLANGIA SAE CODE 61 CURVA A 90° - LUNGA	220	HSS-FL110	 SAE CODE 61 FLANGE 110° ELBOW - LONG DROP FLANGIA SAE CODE 61 CURVA A 110° - LUNGA	222
HSS-FL22	 SAE CODE 61 FLANGE 22,5° ELBOW FLANGIA SAE CODE 61 CURVA A 22,5°	221			

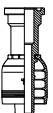
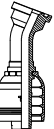
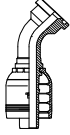
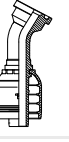
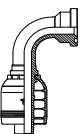
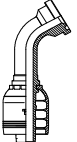
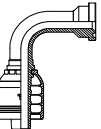
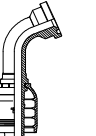

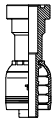
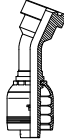
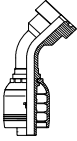
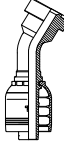
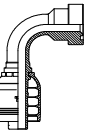
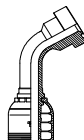
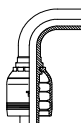
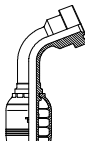

AMERICAN STANDARD CONNECTIONS - FLANGE CODE 62 (SAE J516 / ISO 12151-3)

REFERENCE	DESCRIPTION	PAGE	REFERENCE	DESCRIPTION	PAGE
HSS-FP	 SAE CODE 62 FLANGE FLANGIA SAE CODE 62	223	HSS-FP22	 SAE CODE 62 FLANGE 22,5° ELBOW FLANGIA SAE CODE 62 CURVA A 22,5°	224
HSS-FP45	 SAE CODE 62 FLANGE 45° ELBOW FLANGIA SAE CODE 62 CURVA A 45°	223	HSS-FP30	 SAE CODE 62 FLANGE 30° ELBOW FLANGIA SAE CODE 62 CURVA A 30°	224
HSS-FP90	 SAE CODE 62 FLANGE 90° ELBOW FLANGIA SAE CODE 62 CURVA A 90°	223	HSS-FP60	 SAE CODE 62 FLANGE 60° ELBOW FLANGIA SAE CODE 62 CURVA A 60°	224
HSS-FP90-K-	 SAE CODE 62 FLANGE 90° ELBOW - LONG DROP FLANGIA SAE CODE 62 CURVA A 90° - LUNGA	223	HSS-FP67	 SAE CODE 62 FLANGE 67,5° ELBOW FLANGIA SAE CODE 62 CURVA A 67,5°	224

OEM CONNECTIONS - "SUPERCAT" FLANGE

REFERENCE	DESCRIPTION	PAGE	REFERENCE	DESCRIPTION	PAGE
HSS-YP	 "SUPERCAT" FLANGE FLANGIA "SUPERCAT"	225	HSS-YP22	 "SUPERCAT" FLANGE 22,5° ELBOW FLANGIA "SUPERCAT" CURVA A 22,5°	226
HSS-YP45	 "SUPERCAT" FLANGE 45° ELBOW FLANGIA "SUPERCAT" CURVA A 45°	225	HSS-YP30	 "SUPERCAT" FLANGE 30° ELBOW FLANGIA "SUPERCAT" CURVA A 30°	226
HSS-YP90	 "SUPERCAT" FLANGE 90° ELBOW FLANGIA "SUPERCAT" CURVA A 90°	225	HSS-YP60	 "SUPERCAT" FLANGE 60° ELBOW FLANGIA "SUPERCAT" CURVA A 60°	227
HSS-YP90-K-	 "SUPERCAT" FLANGE 90° ELBOW - LONG DROP FLANGIA "SUPERCAT" CURVA A 90° - LUNGA	225	HSS-YP67	 "SUPERCAT" FLANGE 67,5° ELBOW FLANGIA "SUPERCAT" CURVA A 67,5°	227
			DR	 D'RING SEAL FOR "SUPERCAT" FLANGES GUARNIZIONI D'RING PER FLANGE "SUPERCAT"	227

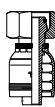
DIN STANDARD CONNECTIONS (DIN20066 / ISO12151-2)

REFERENCE	DESCRIPTION	PAGE	REFERENCE	DESCRIPTION	PAGE
HSS-MM	 METRIC MALE 24° CONE SEAT MASCHIO METRICO SVASATO 24°	228	HSS-FOS45	 METRIC FEMALE 24° O'RING CONE 45° ELBOW - SLIP-ON NUT FEMM. METR. OGIVA 24° O'RING CURVA A 45° - DADO LIBERO	228
HSS-FOS	 METRIC FEMALE 24° O'RING CONE SLIP-ON NUT FEMMINA METRICA OGIVA 24° O'RING DADO LIBERO	228	HSS-FOS90	 METRIC FEMALE 24° O'RING CONE 90° ELBOW - SLIP-ON NUT FEMM. METR. OGIVA 24° O'RING CURVA A 90° - DADO LIBERO	228

FIS45

JIC FEMALE 37° CONE SEAT - 45° ELBOW - TIEFFE NUT
FEMMINA JIC SVASATA 37° - CURVA A 45° - DADO TIEFFE

DKJ45

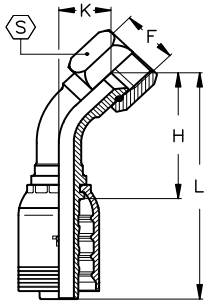

TIEFFE Part.N.	Hose Size			JIC 37° Connection Size		Dimensions (mm)				Maximum W.P.	
	DN	Inch	Dash	F	Dash	H	L	K	S	bar	PSI
HSS2016FIS45	31,5	1 1/4"	-20	1 5/16"-12	-16	100	167	41	41	280	4000
HSS2020FIS45	31,5	1 1/4"	-20	1 5/8"-12	-20	98	164	38	50	210	3000
HSS2024FIS45	31,5	1 1/4"	-20	1 7/8"-12	-24	99	165	39	60	185	2700
HSS2424FIS45	38	1 1/2"	-24	1 7/8"-12	-24	118	201	46	60	185	2700
HSS2432FIS45	38	1 1/2"	-24	2 1/2"-12	-32	122	204	50	75	175	2500
HSS3232FIS45	51	2"	-32	2 1/2"-12	-32	157	253	62	75	175	2500

FIS90

JIC FEMALE 37° CONE SEAT - 90° ELBOW - TIEFFE NUT
FEMMINA JIC SVASATA 37° - CURVA A 90° - DADO TIEFFE

DKJ90

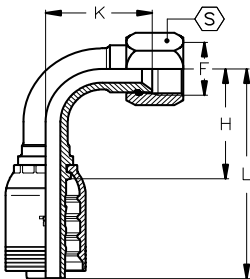

TIEFFE Part.N.	Hose Size			JIC 37° Connection Size		Dimensions (mm)				Maximum W.P.	
	DN	Inch	Dash	F	Dash	H	L	K	S	bar	PSI
HSS2016FIS90	31,5	1 1/4"	-20	1 5/16"-12	-16	87	154	84	41	280	4000
HSS2020FIS90	31,5	1 1/4"	-20	1 5/8"-12	-20	87	154	81	50	210	3000
HSS2024FIS90	31,5	1 1/4"	-20	1 7/8"-12	-24	87	154	82	60	185	2700
HSS2424FIS90	38	1 1/2"	-24	1 7/8"-12	-24	105	188	97	60	185	2700
HSS2432FIS90	38	1 1/2"	-24	2 1/2"-12	-32	105	188	102	75	175	2500
HSS3232FIS90	51	2"	-32	2 1/2"-12	-32	140	237	132	75	175	2500

FIS90

LONG DROP

JIC FEMALE 37° CONE SEAT - 90° ELBOW - LONG DROP - TIEFFE NUT
FEMMINA JIC SVASATA 37° - CURVA A 90° LUNGA - DADO TIEFFE

DKJ90
LONG DROP

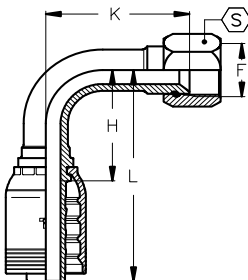

TIEFFE Part.N.	Hose Size			JIC 37° Connection Size		Dimensions (mm)				Maximum W.P.	
	DN	Inch	Dash	F	Dash	H	L	K	S	bar	PSI
HSS2020FIS90-K136	31,5	1 1/4"	-20	1 5/8"-12	-20	87	154	136	50	210	3000
HSS2424FIS90-K162	38	1 1/2"	-24	1 7/8"-12	-24	105	188	162	60	185	2700
HSS3232FIS90-K220	51	2"	-32	2 1/2"-12	-32	140	137	220	75	175	2500

FRS45

ORFS FEMALE - 45° ELBOW - SLIP-ON NUT
FEMMINA ORFS - CURVA A 45° - DADO LIBERO

DK ORFS 45

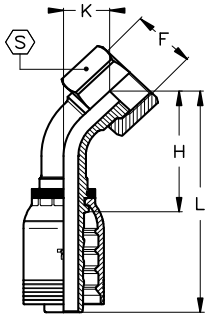

TIEFFE Part.N.	Hose Size			ORFS Connection Size		Dimensions (mm)				Maximum W.P.	
	DN	Inch	Dash	F	Dash	H	L	K	S	bar	PSI
HSS2020FRS45	31,5	1 1/4"	-20	1 11/16"-12	-20	93	159	34	50	345	5000
HSS2424FRS45	38	1 1/2"	-24	2"-12	-24	113	195	41	60	290	4200

FRS90

ORFS FEMALE - 90° ELBOW - SLIP-ON NUT
FEMMINA ORFS - CURVA A 90° - DADO LIBERO

DK ORFS 90

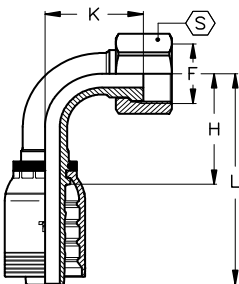

TIEFFE Part.N.	Hose Size			ORFS Connection Size		Dimensions (mm)				Maximum W.P.	
	DN	Inch	Dash	F	Dash	H	L	K	S	bar	PSI
HSS2020FRS90	31,5	1 1/4"	-20	1 11/16"-12	-20	87	153	75	50	345	5000
HSS2424FRS90	38	1 1/2"	-24	2"-12	-24	105	187	90	60	290	4200

DK ORFS 90 □LO

ORFS FEMALE - 90° ELBOW - LONG DROP - SLIP-ON NUT
FEMMINA ORFS - CURVA A 90° - LUNGA - DADO LIBERO

DK ORFS 90
LONG DROP

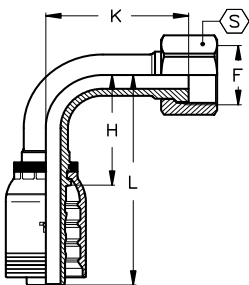

TIEFFE Part.N.	Hose Size			ORFS Connection Size		Dimensions (mm)				Maximum W.P.	
	DN	Inch	Dash	F	Dash	H	L	K	S	bar	PSI
HSS2020FRS90-K130	31,5	1 1/4"	-20	1 11/16"-12	-20	87	153	130	50	345	5000
HSS2424FRS90-K155	38	1 1/2"	-24	2"-12	-24	105	187	155	60	290	4200

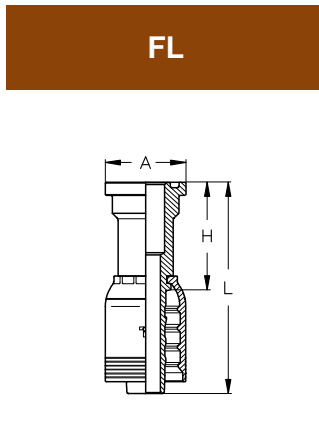

SAE CODE 61 FLANGE
FLANGIA SAE CODE 61

SFL

TIEFFE Part.N.	Hose Size			Flange Size Connection		Dimensions (mm)					Maximum W.P.	
	DN	Inch	Dash	Inch	Dash	H	L	A			bar	PSI
HSS2016FL	31,5	1 1/4"	-20	1"	-16	64	130,5	44,5			350	5000
HSS2020FL	31,5	1 1/4"	-20	1 1/4"	-20	64	130,5	50,8			280	4000
HSS2024FL	31,5	1 1/4"	-20	1 1/2"	-24	68	134,5	60,4			210	3000
HSS2032FL	31,5	1 1/4"	-20	2"	-32	75	141,5	71,4			210	3000
HSS2424FL	38	1 1/2"	-24	1 1/2"	-24	73	155,5	60,4			210	3000
HSS2432FL	38	1 1/2"	-24	2"	-32	76	158,5	71,4			210	3000
HSS3232FL	51	2"	-32	2"	-32	77	176,5	71,4			210	3000
HSS3240FL	51	2"	-32	2 1/2"	40	90	186,5	84,1			175	2500

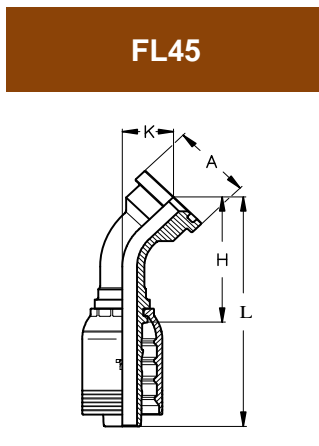

SAE CODE 61 FLANGE - 45° ELBOW
FLANGIA SAE CODE 61 - CURVA A 45°

SFL45

TIEFFE Part.N.	Hose Size			Flange Size Connection		Dimensions (mm)					Maximum W.P.	
	DN	Inch	Dash	Inch	Dash	H	L	K	A		bar	PSI
HSS2016FL45	31,5	1 1/4"	-20	1"	-16	96	163	37	44,5		350	5000
HSS2020FL45	31,5	1 1/4"	-20	1 1/4"	-20	91	157	32	50,8		280	4000
HSS2024FL45	31,5	1 1/4"	-20	1 1/2"	-24	91	157	32	60,4		210	3000
HSS2424FL45	38	1 1/2"	-24	1 1/2"	-24	108	191	36	60,4		210	3000
HSS2432FL45	38	1 1/2"	-24	2"	-32	107	189	35	71,4		210	3000
HSS3232FL45	51	2"	-32	2"	-32	151	245	57	71,4		210	3000
HSS3240FL45	51	2"	-32	2 1/2"	-40	146	243	51	84,1		175	2500

FL90

SAE CODE 61 FLANGE - 90° ELBOW
FLANGIA SAE CODE 61 - CURVA A 90°

SFL90

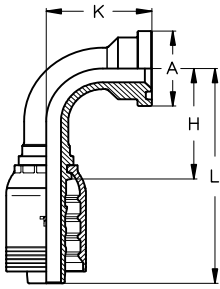

TIEFFE Part.N.	Hose Size			Flange Size Connection		Dimensions (mm)					Maximum W.P.	
	DN	Inch	Dash	Inch	Dash	H	L	K	A		bar	PSI
HSS2016FL90	31,5	1 1/4"	-20	1"	-16	87	154	79	44,5		350	5000
HSS2020FL90	31,5	1 1/4"	-20	1 1/4"	-20	87	154	71	50,8		280	4000
HSS2024FL90	31,5	1 1/4"	-20	1 1/2"	-24	87	154	71	60,4		210	3000
HSS2424FL90	38	1 1/2"	-24	1 1/2"	-24	105	188	83	60,4		210	3000
HSS2432FL90	38	1 1/2"	-24	2"	-32	105	188	81	71,4		210	3000
HSS3232FL90	51	2"	-32	2"	-32	140	237	122	71,4		210	3000
HSS3240FL90	51	2"	-32	2 1/2"	-40	140	237	117	84,1		175	2500

FL 90

LONG DROP

SAE CODE 61 FLANGE - 90° ELBOW - LONG DROP
FLANGIA SAE CODE 61 - CURVA A 90° - LUNGA

SFL90
LONG DROP

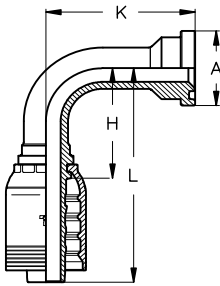

TIEFFE Part.N.	Hose Size			Flange Size Connection		Dimensions (mm)					Maximum W.P.	
	DN	Inch	Dash	Inch	Dash	H	L	K	A		bar	PSI
HSS2020FL90-K91	31,5	1 1/4"	-20	1 1/4"	-20	87	154	91	50,8		280	4000
HSS2020FL90-K102	31,5	1 1/4"	-20	1 1/4"	-20	87	154	102	50,8		280	4000
HSS2020FL90-K112	31,5	1 1/4"	-20	1 1/4"	-20	87	154	112	50,8		280	4000
HSS2020FL90-K130	31,5	1 1/4"	-20	1 1/4"	-20	87	154	130	50,8		280	4000
HSS2020FL90-K168	31,5	1 1/4"	-20	1 1/4"	-20	87	154	168	50,8		280	4000
HSS2024FL90-K118	31,5	1 1/4"	-20	1 1/2"	-24	87	154	118	60,4		210	3000
HSS2024FL90-K130	31,5	1 1/4"	-20	1 1/2"	-24	87	154	130	60,4		210	3000
HSS2424FL90-K148	38	1 1/2"	-24	1 1/2"	-24	105	188	148	60,4		210	3000
HSS2424FL90-K172	38	1 1/2"	-24	1 1/2"	-24	105	188	172	60,4		210	3000
HSS2432FL90-K115	38	1 1/2"	-24	2"	-32	105	188	115	71,4		210	3000
HSS2432FL90-K172	38	1 1/2"	-24	2"	-32	105	188	172	71,4		210	3000
HSS3232FL90-K165	51	2"	-32	2"	-32	140	237	165	71,4		210	3000
HSS3232FL90-K203	51	2"	-32	2"	-32	140	237	203	71,4		210	3000

FL22

SAE CODE 61 FLANGE - 22,5° ELBOW
FLANGIA SAE CODE 61 - CURVA A 22,5°

SFL22,5

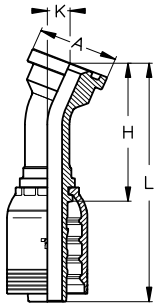

TIEFFE Part.N.	Hose Size			Flange Size Connection		Dimensions (mm)					Maximum W.P.	
	DN	Inch	Dash	Inch	Dash	H	L	K	A		bar	PSI
HSS2020FL22	31,5	1 1/4"	-20	1 1/4"	-20	100	166	13	50,8		280	4000
HSS2024FL22	31,5	1 1/4"	-20	1 1/2"	-24	100	166	13	60,4		210	3000
HSS2424FL22	38	1 1/2"	-24	1 1/2"	-24	118	201	15	60,4		210	3000
HSS2432FL22	38	1 1/2"	-24	2"	-32	116	199	14	71,4		210	3000
HSS3232FL22	51	2"	-32	2"	-32	165	262	22	71,4		210	3000

FL30

SAE CODE 61 FLANGE - 30° ELBOW
FLANGIA SAE CODE 61 - CURVA A 30°

SFL30

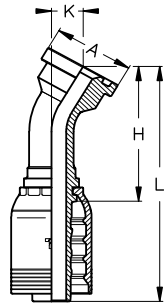

TIEFFE Part.N.	Hose Size			Flange Size Connection		Dimensions (mm)					Maximum W.P.	
	DN	Inch	Dash	Inch	Dash	H	L	K	A		bar	PSI
HSS2020FL30	31,5	1 1/4"	-20	1 1/4"	-20	98	164	19	50,8		280	4000
HSS2024FL30	31,5	1 1/4"	-20	1 1/2"	-24	98	164	19	60,4		210	3000
HSS2424FL30	38	1 1/2"	-24	1 1/2"	-24	116	199	22	60,4		210	3000
HSS2432FL30	38	1 1/2"	-24	2"	-32	114	197	21	71,4		210	3000
HSS3232FL30	51	2"	-32	2"	-32	162	258	31	71,4		210	3000

FP

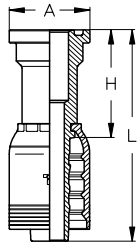

SAE CODE 62 FLANGE FLANGIA SAE CODE 62												SFS	
TIEFFE Part.N.	Hose Size			Flange Size Connection		Dimensions (mm)						Maximum W.P.	
	DN	Inch	Dash	Inch	Dash	H	L	A				bar	PSI
HSS2016FP	31,5	1 1/4"	-20	1"	-16	70	136,5	47,6				415	6000
HSS2020FP	31,5	1 1/4"	-20	1 1/4"	-20	70	136,5	54				415	6000
HSS2024FP	31,5	1 1/4"	-20	1 1/2"	-24	80	146,5	63,5				415	6000
HSS2424FP	38	1 1/2"	-24	1 1/2"	-24	84	116,5	63,5				415	6000
HSS2432FP	38	1 1/2"	-24	2"	-32	99	181,5	79,4				415	6000
HSS3232FP	51	2"	-32	2"	-32	100	196,5	79,4				345	5000

FP45

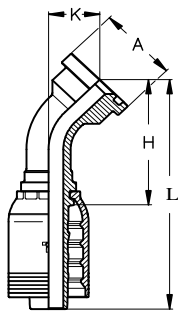

SAE CODE 62 FLANGE - 45° ELBOW FLANGIA SAE CODE 62 - CURVA A 45°												SFS45	
TIEFFE Part.N.	Hose Size			Flange Size Connection		Dimensions (mm)						Maximum W.P.	
	DN	Inch	Dash	Inch	Dash	H	L	K	A			bar	PSI
HSS2016FP45	31,5	1 1/4"	-20	1"	-16	96	163	37	47,6			415	6000
HSS2020FP45	31,5	1 1/4"	-20	1 1/4"	-20	93	160	34	54			415	6000
HSS2024FP45	31,5	1 1/4"	-20	1 1/2"	-24	94	161	35	63,5			415	6000
HSS2424FP45	38	1 1/2"	-24	1 1/2"	-24	112	195	40	63,5			415	6000
HSS2432FP45	38	1 1/2"	-24	2"	-32	115	198	43	79,4			415	6000
HSS3232FP45	51	2"	-32	2"	-32	150	247	56	79,4			345	5000

FP90

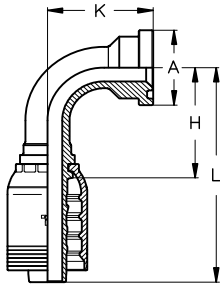

SAE CODE 62 FLANGE - 90° ELBOW FLANGIA SAE CODE 62 - CURVA A 90°												SFS90	
TIEFFE Part.N.	Hose Size			Flange Size Connection		Dimensions (mm)						Maximum W.P.	
	DN	Inch	Dash	Inch	Dash	H	L	K	A			bar	PSI
HSS2016FP90	31,5	1 1/4"	-20	1"	-16	87	154	79	47,6			415	6000
HSS2020FP90	31,5	1 1/4"	-20	1 1/4"	-20	87	154	74	54			415	6000
HSS2024FP90	31,5	1 1/4"	-20	1 1/2"	-24	87	154	76	63,5			415	6000
HSS2424FP90	38	1 1/2"	-24	1 1/2"	-24	105	188	88	63,5			415	6000
HSS2432FP90	38	1 1/2"	-24	2"	-32	105	188	93	79,4			415	6000
HSS3232FP90	51	2"	-32	2"	-32	140	237	123	79,4			345	5000

FP90 □ LONG DR

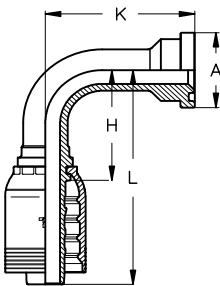

SAE CODE 62 FLANGE - 90° ELBOW - LONG DROP FLANGIA SAE CODE 62 - CURVA A 90° - LUNGA												SFS90 LONG DROP	
TIEFFE Part.N.	Hose Size			Flange Size Connection		Dimensions (mm)						Maximum W.P.	
	DN	Inch	Dash	Inch	Dash	H	L	K	A			bar	PSI
HSS2020FP90-K120	31,5	1 1/4"	-20	1 1/4"	-20	87	154	120	54			415	6000

FP22

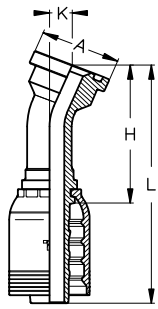

SAE CODE 62 FLANGE - 22,5° ELBOW
FLANGIA SAE CODE 62 - CURVA A 22,5°

SFS22,5

TIEFFE Part.N.	Hose Size			Flange Size Connection		Dimensions (mm)					Maximum W.P.	
	DN	Inch	Dash	Inch	Dash	H	L	K	A		bar	PSI
HSS2020FP22	31,5	1 1/4"	-20	1 1/4"	-20	103	169	15	54		415	6000
HSS2024FP22	31,5	1 1/4"	-20	1 1/2"	-24	104	171	15	63,5		415	6000
HSS2424FP22	38	1 1/2"	-24	1 1/2"	-24	123	206	17	63,5		415	6000
HSS2432FP22	38	1 1/2"	-24	2"	-32	127	210	19	79,4		415	6000
HSS3232FP22	51	2"	-32	2"	-32	166	263	24	79,4		345	5000

FP30

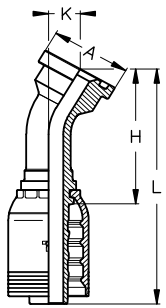

SAE CODE 62 FLANGE - 30° ELBOW
FLANGIA SAE CODE 62 - CURVA A 30°

SFS30

TIEFFE Part.N.	Hose Size			Flange Size Connection		Dimensions (mm)					Maximum W.P.	
	DN	Inch	Dash	Inch	Dash	H	L	K	A		bar	PSI
HSS2020FP30	31,5	1 1/4"	-20	1 1/4"	-20	100	167	20	54		415	6000
HSS2024FP30	31,5	1 1/4"	-20	1 1/2"	-24	102	168	21	63,5		415	6000
HSS2424FP30	38	1 1/2"	-24	1 1/2"	-24	121	203	24	63,5		415	6000
HSS2432FP30	38	1 1/2"	-24	2"	-32	124	207	26	79,4		415	6000
HSS3232FP30	51	2"	-32	2"	-32	162	259	34	79,4		345	5000

FP60

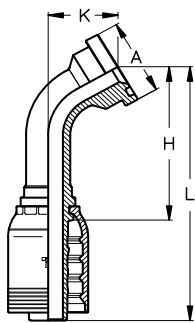

SAE CODE 62 FLANGE - 60° ELBOW
FLANGIA SAE CODE 62 - CURVA A 60°

SFS60

TIEFFE Part.N.	Hose Size			Flange Size Connection		Dimensions (mm)					Maximum W.P.	
	DN	Inch	Dash	Inch	Dash	H	L	K	A		bar	PSI
HSS2020FP60	31,5	1 1/4"	-20	1 1/4"	-20	119	185	47	54		415	6000
HSS2024FP60	31,5	1 1/4"	-20	1 1/2"	-24	120	186	49	63,5		415	6000
HSS2424FP60	38	1 1/2"	-24	1 1/2"	-24	143	225	56	63,5		415	6000
HSS2432FP60	38	1 1/2"	-24	2"	-32	145	228	60	79,4		415	6000
HSS3232FP60	51	2"	-32	2"	-32	193	289	79	79,4		345	5000

FP67

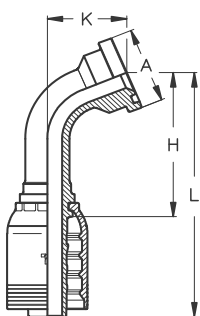

SAE CODE 62 FLANGE - 67,5° ELBOW
FLANGIA SAE CODE 62 - CURVA A 67,5°

SFS67,5

TIEFFE Part.N.	Hose Size			Flange Size Connection		Dimensions (mm)					Maximum W.P.	
	DN	Inch	Dash	Inch	Dash	H	L	K	A		bar	PSI
HSS2020FP67	31,5	1 1/4"	-20	1 1/4"	-20	112	179	54	54		415	6000
HSS2024FP67	31,5	1 1/4"	-20	1 1/2"	-24	113	180	56	63,5		415	6000
HSS2424FP67	38	1 1/2"	-24	1 1/2"	-24	135	217	65	63,5		415	6000
HSS2432FP67	38	1 1/2"	-24	2"	-32	137	219	69	79,4		415	6000
HSS3232FP67	51	2"	-32	2"	-32	182	278	90	79,4		345	5000

YP

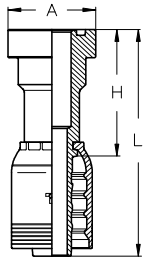

"SUPERCAT" FLANGE FLANGIA "SUPERCAT"											SFS SUPERCAT	
TIEFFE Part.N.	Hose Size			Flange Size Connection		Dimensions (mm)					Maximum W.P.	
	DN	Inch	Dash	Inch	Dash	H	L	A			bar	PSI
HSS2020YP	31,5	1 1/4"	-20	1 1/4"	-20	88	154,4	54			420	6000
HSS2024YP	31,5	1 1/4"	-20	1 1/2"	-24	88	154,5	63,5			420	6000
HSS2424YP	38	1 1/2"	-24	1 1/2"	-24	84	166,5	63,5			420	6000
HSS2432YP	38	1 1/2"	-24	2"	-32	110	192,5	79,4			420	6000
HSS3232YP	51	2"	-32	2"	-32	130	226,5	79,4			350	5000

YP45

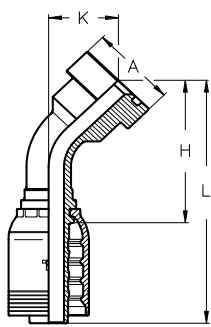

"SUPERCAT" FLANGE - 45° ELBOW FLANGIA "SUPERCAT" - CURVA A 45°											SFS45 SUPERCAT	
TIEFFE Part.N.	Hose Size			Flange Size Connection		Dimensions (mm)					Maximum W.P.	
	DN	Inch	Dash	Inch	Dash	H	L	K	A		bar	PSI
HSS2020YP45	31,5	1 1/4"	-20	1 1/4"	-20	96	162	36	54		420	6000
HSS2024YP45	31,5	1 1/4"	-20	1 1/2"	-24	96	162	36	63,5		420	6000
HSS2424YP45	38	1 1/2"	-24	1 1/2"	-24	114	196	41	63,5		420	6000
HSS2432YP45	38	1 1/2"	-24	2"	-32	116	199	44	79,4		420	6000
HSS3232YP45	51	2"	-32	2"	-32	152	250	57	79,4		350	5000

YP90

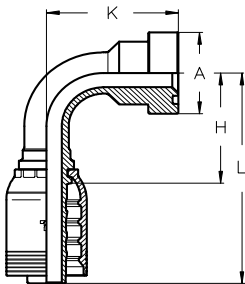

"SUPERCAT" FLANGE - 90° ELBOW FLANGIA "SUPERCAT" - CURVA A 90°											SFS90 SUPERCAT	
TIEFFE Part.N.	Hose Size			Flange Size Connection		Dimensions (mm)					Maximum W.P.	
	DN	Inch	Dash	Inch	Dash	H	L	K	A		bar	PSI
HSS2020YP90	31,5	1 1/4"	-20	1 1/4"	-20	87	154	77	54		420	6000
HSS2024YP90	31,5	1 1/4"	-20	1 1/2"	-24	87	154	78	63,5		420	6000
HSS2424YP90	38	1 1/2"	-24	1 1/2"	-24	105	188	90	63,5		420	6000
HSS2432YP90	38	1 1/2"	-24	2"	-32	105	188	94	79,4		420	6000
HSS3232YP90	51	2"	-32	2"	-32	140	237	125	79,4		350	5000

**YP90
LONG DROP**

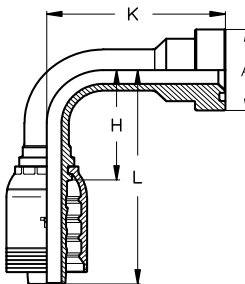

"SUPERCAT" FLANGE - 90° ELBOW - LONG DROP FLANGIA "SUPERCAT" - CURVA A 90° - LUNGA											SFS90 SUPERCAT LONG DROP	
TIEFFE Part.N.	Hose Size			Flange Size Connection		Dimensions (mm)					Maximum W.P.	
	DN	Inch	Dash	Inch	Dash	H	L	K	A		bar	PSI
HSS2020YP90-K150	31,5	1 1/4"	-20	1 1/4"	-20	87	154	150	54		420	6000
HSS2024YP90-K135	31,5	1 1/4"	-20	1 1/2"	-24	87	154	135	63,5		420	6000
HSS2424YP90-K106	38	1 1/2"	24	1 1/2"	-24	105	188	106	63,5		420	6000

YP22

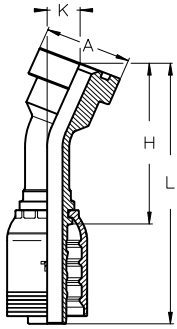

"SUPERCAT" FLANGE - 22,5° ELBOW
FLANGIA "SUPERCAT" - CURVA A 22,5°

SFS22,5
SUPERCAT

TIEFFE Part.N.	Hose Size			Flange Size Connection		Dimensions (mm)						Maximum W.P.	
	DN	Inch	Dash	Inch	Dash	H	L	K	A			bar	PSI
HSS2020YP22	31,5	1 1/4"	-20	1 1/4"	-20	406	172	16	54			420	6000
HSS2024YP22	31,5	1 1/4"	-20	1 1/2"	-24	406	174	16	63,5			420	6000
HSS2424YP22	38	1 1/2"	-24	1 1/2"	-24	125	208	18	63,5			420	6000
HSS2432YP22	38	1 1/2"	-24	2"	-32	129	211	19	79,4			420	6000
HSS3232YP22	51	2"	-32	2"	-32	168	265	25	79,4			350	5000

YP30

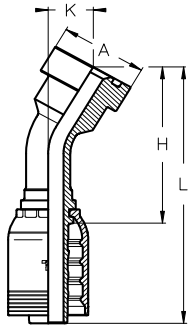

"SUPERCAT" FLANGE - 30° ELBOW
FLANGIA "SUPERCAT" - CURVA A 30°

SFS30
SUPERCAT

TIEFFE Part.N.	Hose Size			Flange Size Connection		Dimensions (mm)						Maximum W.P.	
	DN	Inch	Dash	Inch	Dash	H	L	K	A			bar	PSI
HSS2020YP30	31,5	1 1/4"	-20	1 1/4"	-20	103	170	22	54			420	6000
HSS2024YP30	31,5	1 1/4"	-20	1 1/2"	-24	104	170	23	63,5			420	6000
HSS2424YP30	38	1 1/2"	-24	1 1/2"	-24	123	205	25	63,5			420	6000
HSS2432YP30	38	1 1/2"	-24	2"	-32	126	208	27	79,4			420	6000
HSS3232YP30	51	2"	-32	2"	-32	164	264	35	79,4			350	5000

YP60

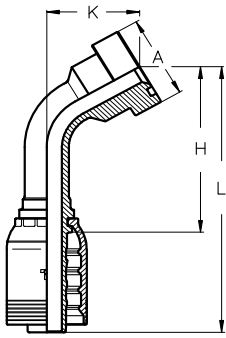

"SUPERCAT" FLANGE - 60° ELBOW
FLANGIA "SUPERCAT" - CURVA A 60°

SFS60
SUPERCAT

TIEFFE Part.N.	Hose Size			Flange Size Connection		Dimensions (mm)					Maximum W.P.	
	DN	Inch	Dash	Inch	Dash	H	L	K	A		bar	PSI
HSS2020YP60	31,5	1 1/4"	-20	1 1/4"	-20	121	187	50	54		420	6000
HSS2024YP60	31,5	1 1/4"	-20	1 1/2"	-24	121	187	51	63,5		420	6000
HSS2424YP60	38	1 1/2"	-24	1 1/2"	-24	144	226	58	63,5		420	6000
HSS2432YP60	38	1 1/2"	-24	2"	-32	146	228	61	79,4		420	6000
HSS3232YP60	51	2"	-32	2"	-32	194	290	81	79,4		350	5000

YP67

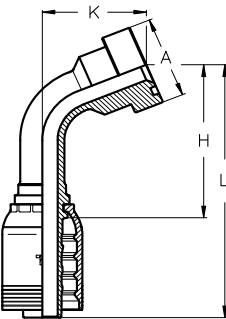

"SUPERCAT" FLANGE - 67,5° ELBOW
FLANGIA "SUPERCAT" - CURVA A 67,5°

SFS67,5
SUPERCAT

TIEFFE Part.N.	Hose Size			Flange Size Connection		Dimensions (mm)					Maximum W.P.	
	DN	Inch	Dash	Inch	Dash	H	L	K	A		bar	PSI
HSS2020YP67	31,5	1 1/4"	-20	1 1/4"	-20	114	181	57	54		420	6000
HSS2024YP67	31,5	1 1/4"	-20	1 1/2"	-24	114	181	58	63,5		420	6000
HSS2424YP67	38	1 1/2"	-24	1 1/2"	-24	137	219	66	63,5		420	6000
HSS2432YP67	38	1 1/2"	-24	2"	-32	138	220	69	79,4		420	6000
HSS3232YP67	51	2"	-32	2"	-32	184	280	92	79,4		350	5000

D'RING SEAL FOR "SUPERCAT" FLANGES
GUARNIZIONI D'RING PER FLANGE "SUPERCAT"

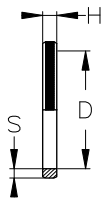

TIEFFE Part.N.	Flange Connection		Dimensions (mm)		
	Inch	Dash	D	H	S
DR20	1 1/4"	-20	38,1	5	3,5
DR24	1 1/2"	-24	44,5	5	3,5
DR32	2"	-32	63,9	5	3,5

MM-S

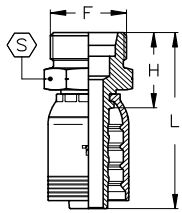

METRIC MALE - 24° CONE SEAT - HEAVY DUTY												CES	
MASCHIO METRICO - SVASATO 24° - SERIE PESANTE													
TIEFFE Part.N.	Hose Size			METRIC 24° Connection		Dimensions (mm)					Maximum W.P.		
	DN	Inch	Dash	F	Pipe	H	L	S			bar	PSI	
HSS20MM30S	31,5	1 1/4"	-20	M42x2	30S	47	113	46			325	4700	
HSS20MM38S	31,5	1 1/4"	-24	M52x2	38S	51	117	55			325	4700	
HSS24MM38S	38	1 1/2"	-24	M52x2	38S	53	135	55			290	4200	

FOS-S

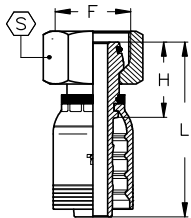

METRIC FEMALE 24° O'RING CONE - HEAVY DUTY - SLIP-ON NUT												DKOS	
FEMMINA METRICA OGIVA 24° O'RING - SERIE PESANTE - DADO LIBERO													
TIEFFE Part.N.	Hose Size			METRIC 24° Connection		Dimensions (mm)					Maximum W.P.		
	DN	Inch	Dash	F	Pipe	H	L	S	O-RING		bar	PSI	
HSS20FOS30S	31,5	1 1/4"	-20	M42x2	30S	43	109	50	25,3x2,4		325	4700	
HSS20FOS38S	31,5	1 1/4"	-20	M52x2	38S	48	115	60	33,3x2,4		325	4700	
HSS24FOS38S	38	1 1/2"	-24	M52x2	38S	51	133	60	33,3x2,4		290	4200	

FOS-S45

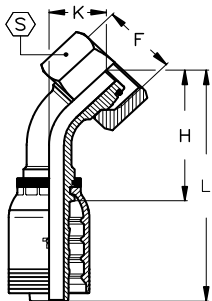

METRIC FEMALE 24° O'RING CONE - 45° ELBOW - HEAVY DUTY - SLIP-ON NUT												DKOS45	
FEMMINA METRICA OGIVA 24° O'RING - CURVA A 45° - SERIE PESANTE - DADO LIBERO													
TIEFFE Part.N.	Hose Size			METRIC 24° Connection		Dimensions (mm)					Maximum W.P.		
	DN	Inch	Dash	F	Pipe	H	L	K	S	O-RING	bar	PSI	
HSS20FOS30S45	31,5	1 1/4"	-20	M42x2	30S	100	166	40	50	25,3x2,4	325	4700	
HSS20FOS38S45	31,5	1 1/4"	-20	M52x2	38S	97	164	38	60	33,3x2,4	325	4700	
HSS24FOS38S45	38	1 1/2"	-24	M52x2	38S	121	203	48	60	33,3x2,4	290	4200	

FOS-S90

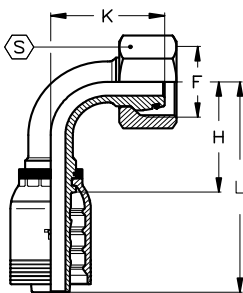

METRIC FEMALE 24° O'RING CONE - 90° ELBOW - HEAVY DUTY - SLIP-ON NUT												DKOS90	
FEMMINA METRICA OGIVA 24° O'RING - CURVA A 90° - SERIE PESANTE - DADO LIBERO													
TIEFFE Part.N.	Hose Size			METRIC 24° Connection		Dimensions (mm)					Maximum W.P.		
	DN	Inch	Dash	F	Pipe	H	L	K	S	O-RING	bar	PSI	
HSS20FOS30S90	31,5	1 1/4"	-20	M42x2	30S	87	154	83	50	25,3x2,4	325	4700	
HSS20FOS38S90	31,5	1 1/4"	-20	M52x2	38S	87	154	80	60	33,3x2,4	325	4700	
HSS24FOS38S90	38	1 1/2"	-24	M52x2	38S	105	188	100	60	33,3x2,4	290	4200	

OUTSIDE SKIVE

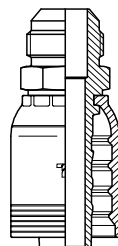

HSS

OUTSIDE SKIVE

RUBBER HOSES STEEL WIRE SPIRAL - TUBI GOMMA SPIRALATI ACCIAIO

Hose Size			ISO 3862 R13 SAE100 R13			ISO 3862 R15 SAE100 R15												Collapse control mandrel Spina controllo collasso				
			"HSS" Fitting Raccordo "HSN"	Skiving length Lungh. di pelatura	Ø Swage (Ref.) Ø Press. (Rif.)	"HSS" Fitting Raccordo "HSN"	Skiving length Lungh. di pelatura	Ø Swage (Ref.) Ø Press. (Rif.)	"HSS" Fitting Raccordo "HSN"	Skiving length Lungh. di pelatura	Ø Swage (Ref.) Ø Press. (Rif.)	"HSS" Fitting Raccordo "HSN"	Skiving length Lungh. di pelatura	Ø Swage (Ref.) Ø Press. (Rif.)	"HSS" Fitting Raccordo "HSN"	Skiving length Lungh. di pelatura	Ø Swage (Ref.) Ø Press. (Rif.)					
DN	Inch	Dash	Part.N.	mm	mm	Part.N.	mm	mm	Part.N.	mm	mm	Part.N.	mm	mm	Part.N.	mm	mm	Part.N.	mm	mm	Part.N.	
31,5	1 1/4"	-20	HSS20	54	51,6	HSS20	54	51,6														
38	1 1/2"	-24	HSS24	69	61	HSS24	69	61														
51	2"	-32	HSS32	80	73																	

BRITISH STANDARD CONNECTIONS - BS5200 / ISO 12151-6

Swivel females - Femmine girevoli	BSP thread <i>Filettatura GAS</i>	TIEFFE end connections <i>Attacchi terminali TIEFFE</i>	Dimensions (mm)		TORQUE VALUES (N.m) <i>COPPIE DI SERRAGGIO (N.m)</i>			
			S	D	Nominal		Maximum	
						+10%		
	1/8"-28	02FGP	14	8,8	10	+10%	13	
	1/4"-19	04FGP-04FGL	19	11,8	20	+10%	25	
	3/8"-19	06FGP-06FGL	22	15,3	35	+10%	45	
	1/2"-14	08FGP-08FGL	27	19,0	60	+10%	80	
	5/8"-14	10FGP-10FGS	30	21,0	70	+10%	90	
	3/4"-14	12FGP-12FGS	32	24,5	115	+10%	140	
	1"-11	16FGP-16FGS	41	30,8	140	+10%	170	
	1 1/4"-11	20FGP-20FGS	50	39,3	210	+10%	280	
	1 1/2"-11	24FGP-24FGS	55	45,3	290	+10%	370	
	2"-11	32FGP-32FGS	70	57,2	400	+10%	500	
		1/4"-19	04FGOL	19	11,8	20	+10%	25
		3/8"-19	06FGOL	22	15,3	35	+10%	45
		1/2"-14	08FGOL	27	19,0	50	+10%	80
		5/8"-14	10FGOS	30	21,0	60	+10%	90
		3/4"-14	12FGOS	32	24,5	85	+10%	140
		1"-11	16FGOS	41	30,8	115	+10%	170
		1 1/4"-11	20FGOS	50	39,3	190	+10%	280
		1 1/2"-11	24FGOS	55	45,3	240	+10%	370
	2"-11	32FGOS	70	57,2	300	+10%	500	
Males - Maschi								
	1/8"-28	02MG	14	9,6				
	1/4"-19	04MG-04MGF	19	13,0				
	3/8"-19	06MG-06MGF	22	16,5				
	1/2"-14	08MG-08MGF	27	20,8				
	5/8"-14	10MG-10MGF	30	22,8				
	3/4"-14	12MG-12MGF	32	26,3				
	1"-11	16MG-16MGF	41	33,1				
	1 1/4"-11	20MG-20MGF	50	41,7				
	1 1/2"-11	24MG	55	47,6				
	2"-11	32MG	70	59,4				

AMERICAN STANDARD CONNECTIONS JIC 37° - SAE J516 / ISO 12151-5

Swivel females - Femmine girevoli	JIC thread <i>Filettatura JIC</i>	TIEFFE end connections <i>Attacchi terminali TIEFFE</i>	Dimensions (mm)		TORQUE VALUES (N.m) <i>COPPIE DI SERRAGGIO (N.m)</i>		
			S	D	Nominal		Maximum
	7/16"-20	04FIP	14	9,9	15	+10%	21
	1/2"-20	05FIP	17	11,5	20	+10%	27
	9/16"-18	06FIP	19	12,9	30	+10%	42
	3/4"-16	08FIP	22	17,5	50	+10%	70
	7/8"-14	10FIP-10FIS	27	20,5	69	+10%	94
	1 1/16"-12	12FIP-12FIS	32	25,0	98	+10%	133
	1 3/16"-12	14FIP-14FIS	36	28,1	118	+10%	163
	1 5/16"-12	16FIP-16FIS	41	31,3	140	+10%	190
	1 5/8"-12	20FIP-20FIS	50	39,0	210	+10%	285
	1 7/8"-12	24FIP-24FIS	60	45,5	290	+10%	380
	2 1/2"-12	32FIP-32FIS	75	61,5	450	+10%	600

Males - Maschi	JIC thread <i>Filettatura JIC</i>	TIEFFE end connections <i>Attacchi terminali TIEFFE</i>	Dimensions (mm)		TORQUE VALUES (N.m) <i>COPPIE DI SERRAGGIO (N.m)</i>		
	7/16"-20	04MI	12	11,0			
	1/2"-20	05MI	14	12,6			
	9/16"-18	06MI	15	14,2			
	3/4"-16	08MI	19	18,9			
	7/8"-14	10MI	24	22,1			
	1 1/16"-12	12MI	27	26,8			
	1 3/16"-12	14MI	32	30,0			
	1 5/16"-12	16MI	34	33,2			
	1 5/8"-12	20MI	42	41,1			
	1 7/8"-12	24MI	50	47,4			
	2 1/2"-12	32MI	65	63,3			

AMERICAN STANDARD CONNECTIONS ORFS - SAE J516 / ISO 12151-1

Swivel females - Femmine girevoli	ORFS thread <i>Filettatura ORFS</i>	TIEFFE end connections <i>Attacchi terminali TIEFFE</i>	Dimensions (mm)		TORQUE VALUES (N.m) <i>COPPIE DI SERRAGGIO (N.m)</i>		
			S	D	Nominal		Maximum
	9/16"-18	04FRS-04FRC	17	12,9	14	±5%	16
	11/16"-16	06FRS-06FRC	22	16,0	24	±5%	27
	13/16"-16	08FRS-08FRC	24	19,2	43	±5%	47
	1"-14	10FRS-10FRC	30	23,7	60	±5%	68
	1 3/16"-12	12FRS-12FRC	36	28,1	90	±5%	95
	1 7/16"-12	16FRS-16FRC	41	34,5	125	±5%	135
	1 11/16"-12	20FRS-20FRC	50	40,9	170	±5%	190
	2"-12	24FRS-24FRC	60	48,7	200	±5%	225

Males - Maschi	ORFS thread <i>Filettatura ORFS</i>	TIEFFE end connections <i>Attacchi terminali TIEFFE</i>	Dimensions (mm)		TORQUE VALUES (N.m) <i>COPPIE DI SERRAGGIO (N.m)</i>		
	9/16"-18	04MRS	17	14,2			
	11/16"-16	06MRS	19	17,3			
	13/16"-16	08MRS	22	20,5			
	1"-14	10MRS	27	25,1			
	1 3/16"-12	12MRS	32	30,0			
	1 7/16"-12	16MRS	41	36,3			
	1 11/16"-12	20MRS	46	42,7			
	2"-12	24MRS	55	50,6			

DIN STANDARD CONNECTIONS - DIN 20066 / ISO 12151-2

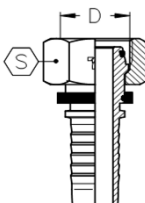
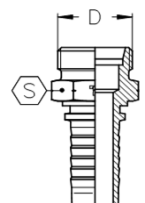
Swivel females - Femmine girevoli	METRIC thread <i>Filettatura METRICA</i>	TIEFFE end connections <i>Attacchi terminali TIEFFE</i>	Dimensions (mm)		TORQUE VALUES (N.m) <i>COPPIE DI SERRAGGIO (N.m)</i>		
			S	D	Nominal		Maximum
						±5%	
	M12x1,5	FOS6L	14	10,5	20	±5%	25
	M14x1,5	FOS8L-FM8L	17	12,5	38	±5%	45
	M16x1,5	FOS10L-FM10L	19	14,5	45	±5%	52
	M18x1,5	FOS12L-FM12L	22	16,5	51	±5%	58
	M22x1,5	FOS15L-FM15L	27	20,5	74	±5%	88
	M26x1,5	FOS18L-FM18L	32	24,5	105	±5%	125
	M30x2	FOS22L	36	28,0	135	±5%	155
	M36x2	FOS28L	41	34,0	166	±5%	192
	M45x2	FOS35L	50	43,0	290	±5%	325
	M52x2	FOS42L	60	50,0	330	±5%	380
	M14x1,5	FOS6S	17	12,5	38	±5%	45
	M16x1,5	FOS8S	19	14,5	45	±5%	52
	M18x1,5	FOS10S	22	16,5	51	±5%	58
	M20x1,5	FOS12S	24	18,5	58	±5%	65
	M22x1,5	FOS14S	27	20,5	74	±5%	88
	M24x1,5	FOS16S	30	22,5	74	±5%	88
	M30x2	FOS20S	36	28,0	135	±5%	155
	M36x2	FOS25S	46	34,0	166	±5%	192
	M42x2	FOS30S	50	40,0	240	±5%	270
	M52x2	FOS38S	60	50,0	330	±5%	380
Males - Maschi							
	M12x1,5	MM6L	12	11,9			
	M14x1,5	MM8L	14	13,9			
	M16x1,5	MM10L	17	15,9			
	M18x1,5	MM12L	19	17,9			
	M22x1,5	MM15L	22	21,9			
	M26x1,5	MM18L	27	25,9			
	M30x2	MM22L	30	29,8			
	M36x2	MM28L	36	35,8			
	M45x2	MM35L	46	44,8			
	M52x2	MM42L	55	51,8			
	M14x1,5	MM6S	14	13,9			
	M16x1,5	MM8S	17	15,9			
	M18x1,5	MM10S	19	17,9			
	M20x1,5	MM12S	22	19,9			
	M22x1,5	MM14S	22	21,9			
	M24x1,5	MM16S	24	23,9			
	M30x2	MM20S	30	29,8			
	M36x2	MM25S	36	35,8			
	M42x2	MM30S	46	41,8			
	M52x2	MM38S	55	51,8			

HOSE ASSEMBLING PROCEDURE
- BY CHECKING INSERT BORE COLLAPSE -

PROCEDURA DI ASSEMBLAGGIO TUBI FLESSIBILI
- METODO DI CONTROLLO DEL COLLASSO FORO -

- 1 - Select the specified hose (A), ferrules (B) and inserts (C) listed in the latest release of TIEFFE hose fittings catalogue. (See Figure 1)

- 1 - Selezionare il tubo flex. (A), le boccole (B) e gli inserti (C) elencati nell'ultima edizione del catalogo TIEFFE. (vedi Figura 1)

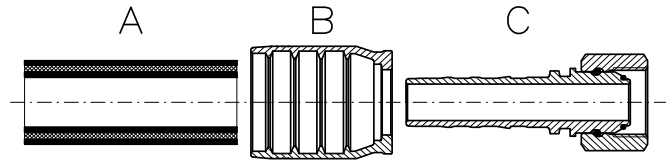

Figure 1

Figura 1

- 2 - Cut the hose squarely using a rotary steel blade (non abrasive) to the required length.
- 3 - **If skiving is required**, remove all rubber cover to the "skiving length" specified in "**SWAGING DATA**" sheets avoiding damages to the steel wires reinforcement.
- 4 - Place the ferrule fully onto the hose. Push the insert fully into the hose. Select "COLLAPSE CONTROL MANDREL" for size and SERIES of TIEFFE inserts. Insert the MANDREL into the insert bore. The "NO GO" part of the MANDREL must fully go into the insert bore. (See Figure 2). Remove the MANDREL.

- 2 - Tagliare il tubo flex. alla lunghezza richiesta, usando una lama rotante di acciaio (non abrasiva).
- 3 - **Se è richiesta la spellatura**, asportare più gomma della copertura possibile, fino alla "lunghezza di spellatura" specificata nelle tabelle "**DATI ASSEMBLAGGIO**", evitando di danneggiare i fili di acciaio del rinforzo.
- 4 - Poizionare la boccola sul tubo flex. Inserire l'inserto nel tubo flex. Selezionare la "SPINA di CONTROLLO COLLASSO" per misura e SERIE dei raccordi TIEFFE. Inserire la SPINA nel foro dell'inserto. La parte "Non Passa" deve entrare completamente nel foro dell'inserto. (Vedi Figura 2). Rimuovere la SPINA.

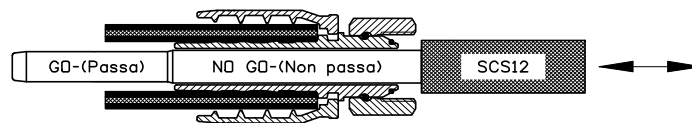

Figure 2

Figura 2

- 5 - Crimp the ferrule to the diameter specified in "**SWAGING DATA**" sheets.
- 6 - Inspect the crimp diameter by measuring it on each pair of dies. All measurements must be taken in the center of ferrule length. All measurements must be according to the specified crimp diameters, within a tolerance $+0,0/-0,2$ mm.
- 7 - Insert the "COLLAPSE CONTROL MANDREL".
- 8 - **If the "NO GO" part of the MANDREL stops in the bore as shown in Figure 3**, crimp diameter and bore collapse are correct.
- 9 - **If the "NO GO" part of the MANDREL goes through to bore**, the crimp diameter must be reduced by increments of 0,1 mm to reach the condition shown in Figure 3.
- 10 - **If the "GO" part of the MANDREL does not go through the bore**, the crimp diameter must be increased (step by step) to reach the condition shown in Figure 3

- 5 - Pressare la boccola al diametro di pressatura specificato nelle tabelle "**DATI ASSEMBLAGGIO**".
- 6 - Controllare il diametro di pressatura misurandolo su ogni coppia di morsetti. Le misure vanno prese al centro della lunghezza della boccola. Tutte le misure prese devono essere in accordo con il diametro di pressatura specificato ($+0,0/-0,2$ mm.).
- 7 - Inserire la "SPINA di CONTROLLO COLLASSO".
- 8 - **Se la parte "Non passa" della "SPINA di CONTROLLO COLLASSO" si blocca nel foro, come evidenziato in Figura 3**, il diametro di pressatura ed il collasso del foro sono corretti.
- 9 - **Se la parte "Non passa" della "SPINA di CONTROLLO COLLASSO" entra completamente nel foro**, il diametro di pressatura deve essere ridotto, di decimo in decimo, fino al verificarsi delle condizioni evidenziate in Figura 3.
- 10 - **Se la parte "Passa" della "SPINA di CONTROLLO COLLASSO" non entra nel foro**, il diametro di pressatura deve essere aumentato, di decimo in decimo, fino al verificarsi delle condizioni evidenziate in Figura 3.

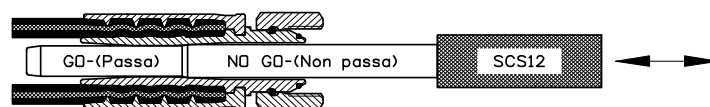
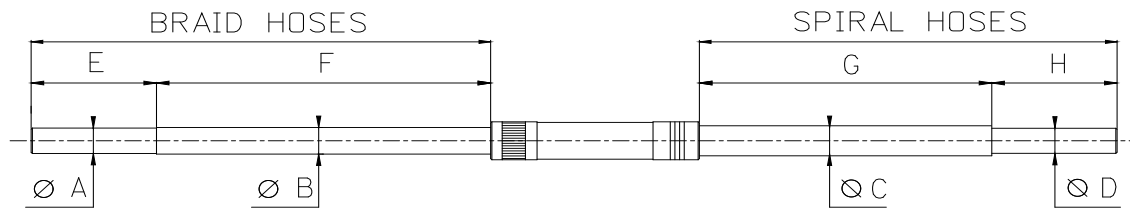
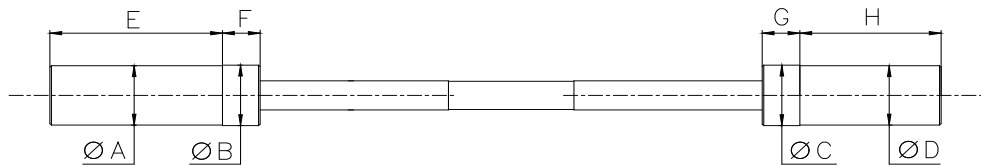

Figure 3

Figura 3

"SCX" COLLAPSE CONTROL MANDREL - SPINE DI CONTROLLO COLLASSO "SCX"

TIEFFE Part.N:	Braid hose							Spiral Hose hose							
	Hose Size			Dimensions (mm)				Dimensions (mm)				Hose Size			
	DN	Inch	Dash	ØA <small>+0,00/-0,05</small>	ØB <small>+0,00/-0,05</small>	E	F	G	H	ØC <small>+0,00/-0,05</small>	ØD <small>+0,00/-0,05</small>	DN	Inch	Dash	
SCX03-05	5	3/16"	-03	2,65	2,85	25	60								
	8	5/16"	-05	5,1	5,3	30	65								
SCX04	6,3	1/4"	-04	3,65	3,85	30	65	65	30	3,65	3,5	6,3	1/4"	-04	
SCX06	10	3/8"	-06	6,3	6,5	30	75	75	30	6,3	6,1	10	3/8"	-06	
SCX08	12,5	1/2"	-08	8,6	9	35	85	85	35	8,6	8,3	12,5	1/2"	-08	
SCX10	16	5/8"	-10	11,2	11,7	40	12	12	40	11,2	10,8	16	5/8"	-10	
SCX12	19	3/4"	-12	13,6	14,1	45	12	12	45	13,6	13,1	19	3/4"	-12	
SCX16	25	1"	-16	19	19,5	55	12	12	55	19	18,4	25	1"	-16	
SCX20	31,5	1 1/4"	-20	24,9	25,4	65	12	12	65	24,9	24,2	31,5	1 1/4"	-20	
SCX24	38	1 1/2"	-24	30,8	31,3	75	12	12	75	30,8	30	38	1 1/2"	-24	
SCX32	51	2"	-32	42	42,5	80	12	12	80	42	41	51	2"	-32	

"SCS" COLLAPSE CONTROL MANDREL - SPINE DI CONTROLLO COLLASSO "SCS"

TIEFFE Part.N.	Hose Size			Dimensions (mm)				Dimensions (mm)				Hose Size		
	DN	Inch	Dash	ØA <small>+0,00/-0,05</small>	ØB <small>+0,00/-0,05</small>	E	F	G	H	ØC <small>+0,00/-0,05</small>	ØD <small>+0,00/-0,05</small>	DN	Inch	Dash
	SCS12-16	19	3/4"	-12	12,6	13,3	55	20	20	60	18,2	17,4	25	1"
SCS20-24	31,5	1 1/4"	-20	22,7	23,6	70	20	20	85	29	28	38	1 1/2"	-24
SCS32	51	2"	-32	37,6	38,8	100	15							

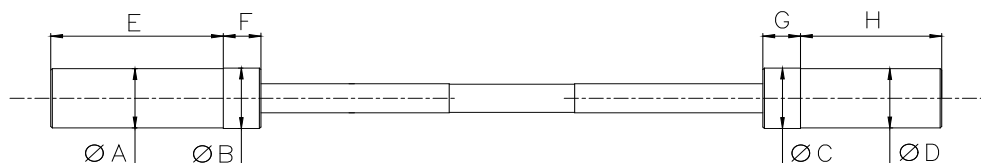
"SCH" COLLAPSE CONTROL MANDREL - SPINE DI CONTROLLO COLLASSO "SCH"

TIEFFE Part.N.	Hose Size			Dimensions (mm)				Dimensions (mm)				Hose Size		
	DN	Inch	Dash	ØA <small>+0,00/-0,05</small>	ØB <small>+0,00/-0,05</small>	E	F	G	H	ØC <small>+0,00/-0,05</small>	ØD <small>+0,00/-0,05</small>	DN	Inch	Dash
	SCH12-16	19	3/4"	-12	12,6	13,1	55	20	20	60	18	17,4	25	1"
SCH20-24	31,5	1 1/4"	-20	23,2	23,9	70	20	20	85	29,8	29	38	1 1/2"	-24
SCH32	51	2"	-32	39,5	40,5	100	15							



TIEFFE S.P.A.

Via dell'Industria 7/11
27010 Cura Carpignano
Pavia - Italy

Tel. (+39) 0382.583020
Fax (+39) 0382.483314

www.tieffe.com
tieffe@tieffe.com

C.F. e Part. IVA: 06256260966 - Capitale Sociale: € 3.330.000,00 i.v.
Reg. Imprese di Pavia n. 06256260966 - R.E.A. n. 261401

