

Tarifa General  
General Price List Tarif Générale  
2012



# DICSA

## Conducciones hidráulicas y neumáticas

Connectique hydraulique et pneumatique  
Hydraulic and pneumatic conducts  
Condutture idrauliche e pneumatiche

Oficinas / Bureau / Offices / Ufficio



Almacén / Entrepôt / Warehouse / Magazzino



Producción / Production / Production / Fabbricazione

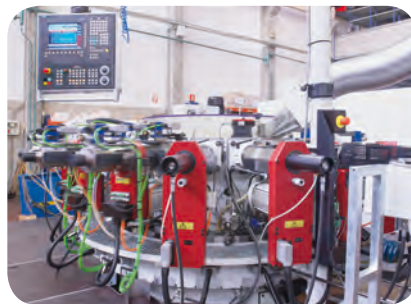

Calidad / Qualité / Quality / Qualità

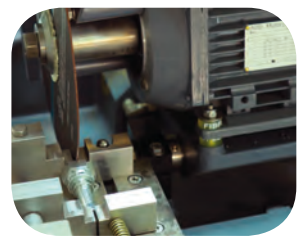

Montaje de latiguillos y tubo rígido / Mounting flexibles and pipe /  
Montage de flexibles et tube rigide / Montaggio di tubi flessibili e tubo rigido

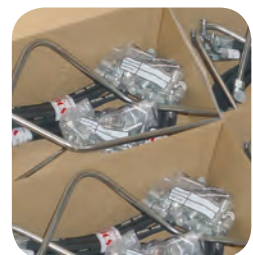

## Flexibles hidráulicos

Flexibles hydrauliques  
Flexible conductions  
Flessibili idrauliche



## Tubo rígido

Conductions rigides  
Pipe conductions  
Tubo rigido



## Accesorios

Accessoires  
Accessories  
Accessori



## Neumática

Pneumatique  
Pneumatic  
Pneumatica





# Flexibles hidráulicos

Flexibles hydrauliques  
Flexible conductions  
Flessibili idrauliche



## Mangueras

Tuyaux  
Hoses  
Tubi flessibili

1

## Racores para tubería flexible

Embouts à sertir  
Flexible hose fittings  
Raccordi per tubi flessibili

2

## Manguera Inox, Racores y Bridas soldables

Tuyau Inox, raccords et brides à souder  
Stainless steel hose, welding fittings and forged flanges  
Tubi Inox, raccordi e flange a saldare

3

## Baja presión

Basse pression  
Low pressure  
Tubi a bassa pressione

4

## Aire acondicionado

Climatisation  
Air conditioned hoses and fittings  
Aria condizionata

5

## Metrología

Test du circuit hydraulique  
Measuring flow  
Test del circuito idraulico

6

## Máquinas tratamiento tubo flexible

Machines pour le montage des flexibles  
Machines for mounting flexibles  
Macchine per l'assemblaggio di tubi flessibili

7

# Mangueras

Tuyaux

Hoses

Tubi flessibili

# 1

Mangueras hidráulicas Triagle Tuyaux hydrauliques Triagle   Hydraulic hoses Triagle   Tubi idraulici Triagle	8
Mangueras hidráulicas TrΔle® Tuyaux hydrauliques TrΔle®   Hydraulic hoses TrΔle®   Tubi idraulici TrΔle®	9
Mangueras PTFE Tuyaux PTFE   PTFE hoses   Tubi PTFE	10
Mangueras termoplásticas Tuyaux thermoplastiques   Thermoplastic hoses   Tubi termoplastici	11
Mangueras industriales Tuyaux industriels   Industrial hoses   Tubi industriali	12



## Mangueras hidráulicas Triagle

Tuyaux hydrauliques Triagle | Hydraulic hoses Triagle | Tubi idraulici Triagle

Hoses

### ▶ **Manguera con malla textil** | Tuyau avec tresse textile | Hose with textile braid | Tubi con teccia tessile

13



MB21

ML7010

MB22

M2503

M7000

MB23

Flexible hose fittings

### ▶ **Manguera 1 y 2 mallas** | Tuyau 1 et 2 tresses | 1 and 2 Braids hoses | Tubi a 1 e 2 trecce metalliche

14



ML2231

ML3509

ML2230

ML3511

Stainless steel hoses  
and fittings

### ▶ **Manguera hidrolavadoras agua caliente** | Tuyau lavage haute pression | Hydrowashing hose for hot water | Tubi per idropulitrici ad acqua calda

14



MC020 G

MC021 A

Low pressure

### ▶ **Manguera 4 y 6 mallas** | Tuyau 4 et 6 tresses | 4 and 6 Braids hoses | Tubi a 4 e 6 trecce metalliche

15



ML4248/ML4290

M4612

ML4569

M4713

M4815

Air conditioned hoses  
and fittings

Measuring flow

Machines for  
mounting flexibles

# Mangueras hidráulicas TrΔle®

Tuyaux hydrauliques TrΔle® | Hydraulic hoses TrΔle® | Tubi idraulici TrΔle®

## ▶ Mangueras hidráulicas TrΔle® | Tuyaux hydrauliques TrΔle® | TrΔle® Hydraulic hoses | Tubi idraulici TrΔle®

16



MSB21



MS3511



MS1SC



MS2230



MS3509



MS2SC



MS4248/MS4290



MS4569

## ▶ Manguera hidrolavadoras agua caliente TrΔle® | Tuyau lavage haute pression TrΔle® | TrΔle® Hydrowashing hose for hot water | Tubi per idropultrici ad acqua calda TrΔle®

17



MSC011



MSC011



MSC02



MSC02

Hoses

Flexible hose fittings

Stainless steel hoses and fittings

Low pressure

Air conditioned hoses and fittings

Measuring flow

Machines for mounting flexibles

# Mangueras PTFE

Tuyaux PTFE | PTFE hoses | Tubi PTFE

## ▶ PTFE liso | PTFE lisse | Smooth PTFE | PTFE liscio

18



M2900



M2912

## ▶ PTFE coarrugado | PTFE convoluté | Convoluted PTFE | PTFE corrugato

18



M2920



M2950

# Mangueras termoplásticas

Tuyaux thermoplastiques | Thermoplastic hoses | Tubi termoplastici

## ▶ **Temoplásticas malla textil** | Thermoplastique tresse textile | Thermoplastic textile braid | Tubi termoplastici con maglia tessile 19



MT07

MT08

MT071

MT27

MT28

MT081

M089K



MP1890

## ▶ **Temoplásticas malla metálica** | Thermoplastique tresse métallique | Thermoplastic metallic braid | Tubi termoplastici con maglia metallica 20



MT09

MT09

MT29

MT29

## ▶ **Limpieza de alcantarillas** | Tuyau hydrocurage | Sewer jetting hose | Tubi per la pulizia di fognature 21



MEC200

M3520

MEC250

Z21200

Hoses

Flexible hose fittings

Stainless steel hoses and fittings

Low pressure

Air conditioned hoses and fittings

Measuring flow

Machines for mounting flexibles

# Mangueras industriales

Tuyaux industriels | Industrial hoses | Tubi industriali

Hoses

## Mangueras para aire y agua | Tuyaux pour air / eau | Air / Water hoses | Tubi aria e acqua



M8000



MA160



MM20



MA1220



MF80



MAS0



ML2250

Flexible hose fittings

Stainless steel hoses and fittings

Low pressure

Air conditioned hoses and fittings

Measuring flow

Machines for mounting flexibles

## Mangueras hidráulicas Triagle

Tuyaux hydrauliques Triagle  
Hydraulic hoses Triagle  
Tubi idraulici Triagle

### SAE 100 R6



SAE 100 R6  
SAE 100 R6  
SAE 100 R6

DN	Ø in	REFERENCIA PART N°	€
1/4"	6	MB2104	6,81
5/16"	8	MB2105	7,37
3/8"	10	MB2106	7,87
1/2"	12	MB2108	8,93
5/8"	16	MB2110	10,18
3/4"	19	MB2112	13,12
1"	25	MB2116	16,99

### SAE 100 R5



SAE 100 R5  
SAE 100 R5  
SAE 100 R5

DN	Ø in	REFERENCIA PART N°	€
3/16"	5	M250304	5,92
1/4"	6	M250305	10,87
5/16"	8	M250306	14,81
13/32"	10	M250308	17,43
1/2"	12	M250310	21,49
5/8"	16	M250312	23,55
7/8"	22	M250316	27,18
1"1/8"	28	M250320	39,80
1"3/8"	35	M250324	43,67
1"13/16"	46	M250332	58,04

### SAE 100 R4

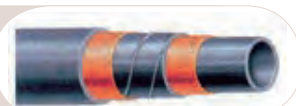

SAE 100 R4  
SAE 100 R4  
SAE 100 R4

DN	Ø in	REFERENCIA PART N°	€
3/4"	19	ML701019	30,93
1"	25	ML701025	33,05
1"1/4"	32	ML701032	37,86
1"1/2"	38	ML701038	42,42
2"	50	ML701050	58,04
2"1/2"	63	ML701063	83,65

### Carbucord 16 bar



Carbucord 16 bar  
Carbucord 16 bar  
Carbucord 16 bar

Ø ext	Ø in	REFERENCIA PART N°	€
41	30	M70003041	34,36
44	32	M70003243	36,17
54	40	M70004054	51,92
64	50	M70005064	79,53

### DIN 20022 2TE / EN 854 2TE



DIN 20022 2TE / EN 854 2TE  
DIN 20022 2TE / EN 854 2TE  
DIN 20022 2TE / EN 854 2TE

DN	Ø in	REFERENCIA PART N°	€
3/16"	5	MB2203	*
1/4"	6	MB2204	*
5/16"	8	MB2205	*
3/8"	10	MB2206	*
1/2"	12	MB2208	*
5/8"	16	MB2210	*
3/4"	19	MB2212	*
1"	25	MB2216	*

### DIN 20022 3TE / EN 854 3TE



DIN 20022 3TE / EN 854 3TE  
DIN 20022 3TE / EN 854 3TE  
DIN 20022 3TE / EN 854 3TE

DN	Ø in	REFERENCIA PART N°	€
3/16"	5	MB2303	*
1/4"	6	MB2304	*
5/16"	8	MB2305	*
3/8"	10	MB2306	*
5/8"	16	MB2310	*
3/4"	19	MB2312	*
1"	25	MB2316	*
1" 1/4"	32	MB2320	*
1" 1/2"	38	MB2324	*

# Mangueras hidráulicas Triagle

Tuyaux hydrauliques Triagle  
Hydraulic hoses Triagle  
Tubi idraulici Triagle

Hoses

Flexible hose fittings

Stainless steel hoses and fittings

Low pressure

Air conditioned hoses and fittings

Measuring flow

Machines for mounting flexibles

## SAE 100 R1A / DIN20022 1ST/EN 853 1ST



SAE R1A / DIN 20022 1ST/EN 853 1ST  
SAE 100 R1A / DIN 20022 1ST/EN 853 1ST  
SAE 100 R1A / DIN 20022 1ST/EN 853 1ST

DN	Ø in	REFERENCIA PART N°	€
1/4"	6	ML223104	5,88
5/16"	8	ML223105	6,69
3/8"	10	ML223106	8,68
1/2"	12	ML223108	9,13
5/8"	16	ML223110	11,92
3/4"	19	ML223112	12,56
1"	25	ML223116	21,74
1" 1/4	32	ML223120	26,23

## SAE 100 R1AT/DIN 20022 1SN/EN 853 1SN



SAE 100 R1AT/DIN 20022 1SN/EN 853 1SN  
SAE 100 R1AT/DIN 20022 1SN/EN 853 1SN  
SAE 100 R1AT/DIN 20022 1SN/EN 853 1SN

DN	Ø in	REFERENCIA PART N°	€
3/16"	5	ML223003	6,75
1/4"	6	ML223004	5,62
5/16"	8	ML223005	6,62
3/8"	10	ML223006	6,94
1/2"	12	ML223008	8,62
5/8"	16	ML223010	10,93
3/4"	19	ML223012	12,93
1"	25	ML223016	18,43
1" 1/4	32	ML223020	30,49
1" 1/2	38	ML223024	35,61
2"	50	ML223032	49,54

## SAE 100 R2A/DIN 20022 2ST/EN 853 2ST



SAE 100 R2A/DIN 20022 2ST/EN 853 2ST  
SAE 100 R2A/DIN 20022 2ST/EN 853 2ST  
SAE 100 R2A/DIN 20022 2ST/EN 853 2ST

DN	Ø in	REFERENCIA PART N°	€
3/16"	5	ML350903	9,56
1/4"	6	ML350904	9,18
5/16"	8	ML350905	10,12
3/8"	10	ML350906	10,43
1/2"	12	ML350908	11,93
5/8"	16	ML350910	15,68
3/4"	19	ML350912	18,06
1"	25	ML350916	27,30
1" 1/4	32	ML350920	42,67
1" 1/2	38	ML350924	50,48
2"	50	ML350932	70,85

## SAE 100 R2AT/DIN 20022 2SN/EN 853 2SN



SAE 100 R2AT/DIN 20022 2SN/EN 853 2SN  
SAE 100 R2AT/DIN 20022 2SN/EN 853 2SN  
SAE 100 R2AT/DIN 20022 2SN/EN 853 2SN

DN	Ø in	REFERENCIA PART N°	€
3/16"	5	ML351103	9,12
1/4"	6	ML351104	7,75
5/16"	8	ML351105	8,31
3/8"	10	ML351106	8,81
1/2"	12	ML351108	10,18
5/8"	16	ML351110	13,93
3/4"	19	ML351112	15,81
1"	25	ML351116	22,68
1" 1/4	32	ML351120	40,61
1" 1/2	38	ML351124	46,17
2"	50	ML351132	62,79

## Superservicio agua caliente 2 mallas gris



Superservice eau chaude 2 tresses gris  
Hot water superservice 2 grey braids  
Superservice acqua calda a 2 maglie grigio

DN	Ø in	REFERENCIA PART N°	€
5/16"	8	MC0205G	7,78
3/8"	10	MC0206G	9,25

## Superservicio agua caliente 2 mallas azul



Superservice eau chaude 2 tresses bleu  
Hot water superservice 2 blue braids  
Superservice acqua calda a 2 maglie azzurro

DN	Ø in	REFERENCIA PART N°	€
5/16"	8	MC0215A	7,78
3/8"	10	MC0216A	9,25

## Mangueras hidráulicas Triagle

Tuyaux hydrauliques Triagle  
Hydraulic hoses Triagle  
Tubi idraulici Triagle

### SAE 100 R9R-R10/DIN 20023 4SP/EN 856 4SP



SAE 100 R9R-R10/DIN 20023 4SP/EN 856 4SP  
SAE 100 R9R-R10/DIN 20023 4SP/EN 856 4SP  
SAE 100 R9R-R10/DIN 20023 4SP/EN 856 4SP

DN	Ø in	REFERENCIA PART N°	€
1/4"	6	ML429004	22,30
3/8"	10	ML429006	25,99
1/2"	12	ML429008	27,68
5/8"	16	ML429010	31,61
3/4"	19	ML429012	32,30
1"	25	ML429016	40,36
1" 1/4	32	ML424820	64,16
1" 1/2	38	ML424824	84,78
2"	50	ML424832	121,58

### DIN 20023 4SH/EN 856 4SH



DIN 20023 4SH/EN 856 4SH  
DIN 20023 4SH/EN 856 4SH  
DIN 20023 4SH/EN 856 4SH

DN	Ø in	REFERENCIA PART N°	€
3/4"	19	ML456912	34,61
1"	25	ML456916	42,48
1" 1/4	32	ML456920	68,35
1" 1/2	38	ML456924	86,72
2"	50	ML456932	125,14

### SAE 100 R12/EN 856 R12



SAE 100 R12/EN 856 R12  
SAE 100 R12/EN 856 R12  
SAE 100 R12/EN 856 R12

DN	Ø in	REFERENCIA PART N°	€
3/8"	10	M461206	26,68
1/2"	12	M461208	20,57
3/4"	19	M461212	27,25
1"	25	M461216	36,41
1" 1/4	32	M461220	47,99
1" 1/2	38	M461224	57,58

### SAE 100 R13/EN 856 R13



SAE 100 R13/EN 856 R13  
SAE 100 R13/EN 856 R13  
SAE 100 R13/EN 856 R13

DN	Ø in	REFERENCIA PART N°	€
3/4"	19	M471312	44,05
1"	25	M471316	57,79
1" 1/4	32	M471320	101,58
1" 1/2	38	M471324	138,13
2"	50	M471332	181,80

### SAE 100 R15/SAE J517 R15



SAE 100 R15/SAE J517 R15  
SAE 100 R15/SAE J517 R15  
SAE 100 R15/SAE J517 R15

DN	Ø in	REFERENCIA PART N°	€
1"	25	M481516	63,85
1" 1/4	32	M481520	111,89
1" 1/2	38	M481524	139,88



# Mangueras hidráulicas TrΔle®

Tuyaux hydrauliques TrΔle®

Hydraulic hoses TrΔle®

Tubi idraulici TrΔle®

Hoses

## Manguera R6



Tuyau R6

R6 Hose

Tubi R6

DN	REFERENCIA PART N°	€
1/4	MSB2104	3,37
5/16	MSB2105	4,25
3/8	MSB2106	5,13
1/2	MSB2108	6,82
5/8	MSB2110	8,35
3/4	MSB2112	10,19
1"	MSB2116	13,56

## Manguera R1AT



Tuyau R1AT

R1AT Hose

Tubi R1AT

DN	Ø in	REFERENCIA PART N°	€
1/4"	6	MS223004	3,89
5/16"	8	MS223005	5,11
3/8"	10	MS223006	5,49
1/2"	12	MS223008	6,48
5/8"	16	MS223010	8,31
3/4"	19	MS223012	10,13
1"	25	MS223016	14,33
1" 1/4	32	MS223020	19,43
1" 1/2	38	MS223024	22,17

## Manguera R2AT



Tuyau R2AT

R2AT Hose

Tubi R2AT

DN	REFERENCIA PART N°	€
1/4"	MS351104	5,26
5/16"	MS351105	6,55
3/8"	MS351106	6,93
1/2"	MS351108	8,23
5/8"	MS351110	10,51
3/4"	MS351112	12,42
1"	MS351116	17,45
1" 1/4	MS351120	24,76
1" 1/2	MS351124	28,96
2"	MS351132	34,90

## Manguera R2A 2ST



Tuyau R2A 2ST

R2A 2ST Hose

Tubi R2A 2ST

DN	REFERENCIA PART N°	€
1/4"	MS350904	5,35
5/16"	MS350905	7,03
3/8"	MS350906	7,84
1/2"	MS350908	9,90
5/8"	MS350910	12,31
3/4"	MS350912	14,29
1"	MS350916	19,63

## 1SC/EN857 1SC



Tuyau 1SC

1SC Hose

Tubi 1SC

DN	Ø in	REFERENCIA PART N°	€
1/4"	6	MS1SC04	3,89
5/16"	8	MS1SC05	5,11
3/8"	10	MS1SC06	5,49
1/2"	12	MS1SC08	6,48
5/8"	16	MS1SC10	8,31
1/2"	19	MS1SC12	10,13
1"	25	MS1SC16	14,33

## 2SC/EN857 2SC



Tuyau 2SC

2SC Hose

Tubi 2SC

DN	Ø in	REFERENCIA PART N°	€
1/4"	6	MS2SC04	5,26
5/16"	8	MS2SC05	6,55
3/8"	10	MS2SC06	6,93
1/2"	12	MS2SC08	8,23
5/8"	16	MS2SC10	10,51
3/4"	19	MS2SC12	12,42
1"	25	MS2SC16	17,45

Flexible hose fittings

Stainless steel hoses  
and fittings

Low pressure

Air conditioned hoses  
and fittings

Measuring flow

Machines for  
mounting flexibles

## Mangueras hidráulicas TrΔle®

Tuyaux hydrauliques TrΔle®

Hydraulic hoses TrΔle®

Tubi idraulici TrΔle®

### Manguera 4SP



Tuyau 4SP  
4SP Hose  
Tubi 4SP

DN	REFERENCIA PART N°	€
3/8"	MS429006	18,98
1/2"	MS429008	20,57
5/8"	MS429010	24,91
3/4"	MS429012	25,76
1"	MS429016	32,85
1"1/4	MS424820	49,90
2"	MS424832	60,10

### Manguera 4SH



Tuyau 4SH  
4SH Hose  
Tubi 4SH

DN	REFERENCIA PART N°	€
3/4"	MS456912	27,84
1"	MS456916	36,95
1"1/4	MS456920	53,72

### Superservicio agua caliente 1 malla negra



Superservice eau chaude 1 tresse noir  
Hot water superservice 1 black braid  
Superservice acqua calda 1 treccia, nero

DN	Ø in	REFERENCIA PART N°	€
1/4"	6	MSC0114N	4,67
5/16"	8	MSC0115N	5,57
3/8"	10	MSC0116N	6,23
1/2"	12	MSC0118N	7,99

### Superservicio agua caliente 2 mallas negra



Superservice eau chaude 2 tresses noir  
Hot water superservice 2 black braids  
Superservice acqua calda 2 trecce, nero

DN	Ø in	REFERENCIA PART N°	€
1/4"	6	MSC0214N	5,43
5/16"	8	MSC0215N	7,03
3/8"	10	MSC0216N	8,03
1/2"	12	MSC0218N	10,26

### Superservicio agua caliente 1 malla Azul

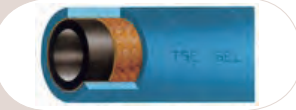

Superservice eau chaude 1 tresse bleu  
Hot water superservice 1 blue braid  
Superservice acqua calda 1 treccia, azzurro

DN	Ø in	REFERENCIA PART N°	€
1/4"	6	MSC0114A	4,90
5/16"	8	MSC0115A	5,85
3/8"	10	MSC0116A	6,55
1/2"	12	MSC0118A	8,38

### Superservicio agua caliente 2 mallas azul



Superservice eau chaude 2 tresses bleu  
Hot water superservice 2 blue braids  
Superservice acqua calda 2 trecce, azzurro

DN	Ø in	REFERENCIA PART N°	€
1/4"	6	MSC0214A	5,50
5/16"	8	MSC0215A	7,33
3/8"	10	MSC0216A	8,43
1/2"	12	MSC0218A	10,77

# Mangueras PTFE

Tuyaux PTFE  
PTFE hoses  
Tubi PTFE

## PTFE Liso 1 malla



FHL (série légère)

FHL (light)

FHL (serie leggera)

DN	Ø in	REFERENCIA PART N°	€
3/16"	5	M290005	15,94
1/4"	6	M290006	13,95
5/16"	8	M290008	18,35
3/8"	9	M290009	19,09
13/32"	10	M290010	24,23
1/2"	13	M290013	26,43
5/8"	16	M290016	36,71
3/4"	19	M290020	45,52
1"	25	M290025	69,74

## PTFE Liso grueso 2 mallas



FHM 2 tresses

FHM 2 Braids

FHM doppia maglia

DN	Ø in	REFERENCIA PART N°	€
1/4"	6	M2901206	25,75
5/16"	8	M2901208	27,52
3/8"	9	M2901209	32,17
1/2"	13	M2901213	45,59
5/8"	16	M2901216	63,46
3/4"	19	M2901219	76,01
1"	25	M2901225	107,54

## PTFE coarugado 1 malla



PTFE convoluté

Convolutated PTFE

Teflon corrugato

DN	Ø in	REFERENCIA PART N°	€
1/4"	6	M292006	34,56
3/8"	10	M292009	44,56
1/2"	13	M292013	50,65
5/8"	16	M292016	58,00
3/4"	19	M292020	67,54
1"	25	M292025	99,11
1"1/4	32	M292032	172,52
1"1/2	38	M292038	222,80
2"	50	M292050	262,08

## PTFE sin malla



PTFE sans tresse

PTFE without braid

PTFE senza maglia

TUBO PIPE	LONGITUD (M) LENGTH (M)	REFERENCIA PART N°	€
2x4	25	M2950204	*
4x6	25	M2950406	*
6x8	25	M2950608	*
2x4	100	M2950204-100	*
4x6	100	M2950406-100	*
6x8	100	M2950608-100	*

Ver precios en p. 313 (NEUMÁTICA) // Prix à la p. 313 (PNEUMATIQUE) // See prices in p. 313 (PNEUMATIC) // Vedere prezzi p. 313 (PNEUMATICA)

## Mangueras termoplásticas

Tuyaux thermoplastiques  
Thermoplastic hoses  
Tubi termoplastici

### SAE 100 R7



SAE 100 R7  
SAE 100 R7  
SAE 100 R7

DN	Ø in	REFERENCIA PART N°	€
1/8"	4	MT07002	3,87
3/16"	5	MT07003	4,35
1/4"	6	MT07004	5,25
5/16"	8	MT07005	7,47
3/8"	10	MT07006	8,06
1/2"	13	MT07008	11,61
5/8"	16	MT07010	17,12
3/4"	20	MT07012	19,29
1"	25	MT07016	29,04

### SAE 100 R7 Bitubo



SAE 100 R7 Jumelé  
SAE 100 R7 Two tubes  
SAE 100 R7 Binato

DN	Ø in	REFERENCIA PART N°	€
3/16"	5	MT27003	9,91
1/4"	6	MT27004	11,82
5/16"	8	MT27005	16,22
3/8"	10	MT27006	17,38
1/2"	13	MT27008	24,49

### SAE 100 R8



SAE 100 R8  
SAE 100 R8  
SAE 100 R8

DN	Ø in	REFERENCIA PART N°	€
3/16"	5	MT08003	8,11
1/4"	6	MT08004	13,52
5/16"	8	MT08005	14,79
3/8"	10	MT08006	19,45
1/2"	13	MT08008	25,76
5/8"	16	MT08010	32,17
3/4"	20	MT08012	41,18
1"	25	MT08016	59,20

### SAE 100 R8 Bitubo



SAE 100 R8 Jumelé  
SAE 100 R8 Two tubes  
SAE 100 R8 Binato

DN	Ø in	REFERENCIA PART N°	€
1/4"	6	MT28004	26,48
5/16"	8	MT28005	28,89
3/8"	10	MT28006	37,56
1/2"	13	MT28008	49,38

### SAE 100 R8 no conductiva



SAE 100 R8 non-conducteur  
SAE 100 R8 non-conductive  
SAE 100 R8 non conduttivo

DN	Ø in	REFERENCIA PART N°	€
1/4"	6	MT08104	12,88
5/16"	8	MT08105	14,15
3/8"	10	MT08106	18,55
1/2"	13	MT08108	24,59
5/8"	16	MT08110	30,74
3/4"	20	MT08112	39,33
1"	25	MT08116	56,55

### SAE 100 R7 no conductiva



SAE 100 R7 non-conducteur  
SAE 100 R7 non-conductive  
SAE 100 R7 non conduttivo

DN	Ø in	REFERENCIA PART N°	€
1/4"	6	MT07104	5,04
5/16"	8	MT07105	7,10
3/8"	10	MT07106	7,69
1/2"	13	MT07108	11,13
5/8"	16	MT07110	16,32
3/4"	20	MT07112	18,44
1"	25	MT07116	27,72

### MICRO-HOSE



MICRO-HOSE  
MICRO-HOSE  
MICRO-HOSE

Ø in	REFERENCIA PART N°	€
2	MT01002	*

Ver p. 122 (Metrologia) // Voir p. 122 (Test du circuit hydraulique) // See p. 122 (Measuring flow) // Vedere p. 122 (Test del circuito idraulico)

## Mangueras termoplásticas

Tuyaux thermoplastiques  
Thermoplastic hoses  
Tubi termoplastici

Hoses

### Termoplásticas Push-on



Thermoplastique Push-on

Thermoplastic Push-on

Tubi termoplastici Push-on

Ø in	REFERENCIA PART N°	€
1/4"	MP189004	5,51
3/8"	MP189006	7,42
1/2"	MP189008	12,03
5/8"	MP189010	16,17
3/4"	MP189012	19,56

Flexible hose fittings

### Elastómero malla metálica



Elastomère 1 tresse métallique

Metallic braid elastomer

Maglia Metallica

DN	Ø in	REFERENCIA PART N°	€
3/16"	5	MT09003	6,41
1/4"	6	MT09004	7,42
5/16"	8	MT09005	8,37
3/8"	10	MT09006	9,65
1/2"	13	MT09008	12,24
5/8"	16	MT09010	16,22
3/4"	20	MT09012	18,29
1"	25	MT09016	25,76

Stainless steel hoses  
and fittings

Low pressure

### Elastómero malla metálica pintura



Elastomère 1 tresse métallique peinture

Paint metallic braid elastomer

Maglia Metallica per vernici

DN	Ø in	REFERENCIA PART N°	€
3/16"	5	MT099003	6,62
1/4"	6	MT099004	7,63
3/8"	10	MT099006	9,91
1/2"	13	MT099008	12,61
3/4"	20	MT099012	18,76

Air conditioned hoses  
and fittings

Measuring flow

### Elastómero malla metálica bitubo



Elastomère 1 tresse métallique jumelé

Metallic braid elastomer 2 tubes

Maglia Metallica Binato

DN	Ø in	REFERENCIA PART N°	€
3/16"	5	MT29003	14,15
1/4"	6	MT29004	16,06
5/16"	8	MT29005	18,02
3/8"	10	MT29006	20,62
1/2"	13	MT29008	25,76

### Elastómero doble malla metálica pintura



Elastomère 2 tresses métalliques peinture

Paint metallic braid 2 tubes elastomer

Doppia Maglia Metallica per vernici

DN	Ø in	REFERENCIA PART N°	€
1/4"	6	MT299004	12,77
3/8"	10	MT299006	18,60
1/2"	13	MT299008	21,52

Machines for  
mounting flexibles

## Mangueras termoplásticas

Tuyaux thermoplastiques  
Thermoplastic hoses  
Tubi termoplastici

### Ecology 200



Ecology 200  
Ecology 200  
Ecology 200

DN	Ø in	REFERENCIA PART N°	€
3/4"	20	MEC20012	27,56
1"	25	MEC20016	36,52
1" 1/4	32	MEC20020	47,06

### Manguera termoplástica 700 bar



Tuyau thermoplastique haute pression 700 bar  
Thermoplastic hose 700 bar  
Tubo termoplastico 700 bar

DN	Ø in	REFERENCIA PART N°	€
1/4"	6	MT70004	21,62
3/8"	10	MT70006	42,48

Ver p. 61 (Conexiones alta presión) / Voir p. 61 (Embouts haute pression) / See p. 61 (High pressure fittings) / Vedere p. 61 (Raccordi altissima pressione)

### Ecology 250



Ecology 250  
Ecology 250  
Ecology 250

DN	Ø in	REFERENCIA PART N°	€
3/4"	20	MEC25012	40,55
1"	25	MEC25016	56,76

### Casquillos para manguera Ecology

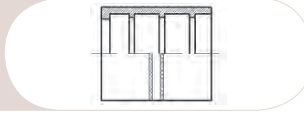

Jupes pour tuyau Ecology  
Ferrules for Ecology hose  
Boccole pressare per tubi Ecologici

DN	REFERENCIA PART N°	€
3/4"	Z212001200	*
1"	Z212001600	*
1"1/4	Z212002000	*

Acero inoxidable AISI 316-L / Acier inoxydable AISI 316-L / Stainless steel AISI 316-L / Acciaio inossidabile AISI 316-L

## Mangueras industriales

Tuyaux industriels  
Industrial hoses  
Tubi industriali

Hoses

Flexible hose fittings

Stainless steel hoses  
and fittings

Low pressure

Air conditioned hoses  
and fittings

Measuring flow

Machines for  
mounting flexibles

### Ariaform aire comprimido y agua-impulsión serie continua



Ariaform refoulement air comprimé et de l'eau  
Ariaform compressed air and water. Continuous serie  
Aria compressa e acqua-impulsi. Serie continua

DN	Ø ext	Ø in	REFERENCIA PART N°	€
1/4"	14	6	M80000614	2,61
5/16"	17	8	M80000817	3,34
3/8"	17	10	M80001017	4,34
1/2"	21	13	M80001321	5,34
5/8"	26	16	M80001626	7,35
3/4"	29	19	M80001929	8,02

### Aire comprimido-impulsión



Air comprimé  
Compressed air  
Aria compressa

Ø ext	Ø in	REFERENCIA PART N°	€
36	25	MA122025	17,77
48	32	MA122032	23,91
56	40	MA122040	29,19
66	51	MA122051	35,67

### Fumigación serie continua



Tuyau fumigation  
Fumigation hose. Continuous serie  
Fumigazione. Serie continua

DN	Ø ext	Ø in	REFERENCIA PART N°	€
3/8"	18	10	MF8010	4,56
1/2"	21	12	MF8012	6,18

### Agua caliente para limpieza industrial

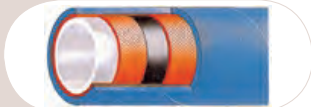

Tuyau pour nettoyage à l'eau chaude  
Industrial cleaning hoses. Hot water  
Acqua calda per pulizia industriale 160°C

DN	Ø ext	Ø in	REFERENCIA PART N°	€
5/8"	28	16	MA1601628	20,24
3/4"	31	19	MA1601931	22,11
1"	38	25	MA1602538	28,32

### Mangueras alimentarias



Tuyaux alimentaires  
Food Hoses  
Tubi alimentare

DN	Ø in	REFERENCIA PART N°	€
1"	25	MAS025	36,94
1" 1/4	32	MAS032	44,22
1" 1/2	38	MAS038	48,16
2"	51	MAS051	62,92
2" 1/2	63	MAS063	79,02
3"	76	MAS076	105,13

### Polivalente serie continua

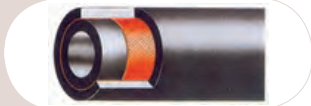

Tuyau polyvalent huiles/carburants  
Multi-function. Continuous serie  
Polivalente. Serie continua

DN	Ø ext	Ø in	REFERENCIA PART N°	€
5/16"	16	8	MM2008	4,15
3/8"	18	10	MM2010	5,21
1/2"	21	13	MM2013	6,35
5/8"	25	16	MM2016	8,74
3/4"	29	19	MM2019	9,62

### Limpieza de alcantarillas malla textil

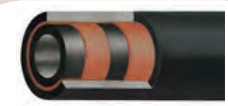

Tuyau hydrocurage avec tresse textile  
Sewer jetting hose with textile braid  
Tubi per la pulizia di fognature con teccia tessile

DN	REFERENCIA PART N°	€
3/4"	ML225012	51,60
1"	ML225016	63,86

**TABLA DE ROSCAS**  
**TABLEAU DES RACCORDS**  
**TABLE PORT THREAD**  
**TABELLE DEI FILETTI**

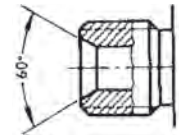
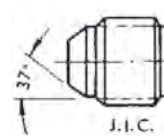
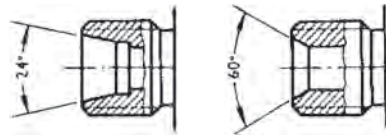

Métrica   Métrique Metrical   Metrica	Ø ext.	Ø int.	Cono 24° 24° Cone	Cono 24° Cono 24°	Cono 60° 60° Cone	Cono 60° Cono 60°	SAE	Ø ext.	Ø int.	BSP	Ø ext.	Ø int.
12 x 1,5	12	10,05	•		•		7/16-20	11,07	10,00	1/4-19	13,16	11,50
14 x 1,5	14	12,05	•		•		1/2-20	12,70	11,60	3/8-19	16,66	14,90
16, x 1,5	16	14,05	•		•		9/16-18	14,25	13,00	1/2-14	20,96	18,60
18 x 1,5	18	16,05	•		•		5/8-18	15,85	14,70	5/8-14	22,91	20,60
20 x 1,5	20	18,05	•		•		3/4-16	19,00	17,60	3/4-14	26,44	24,10
22 x 1,5	22	20,05	•		•		7/8-14	22,17	20,50	1-11	33,25	30,30
24 x 1,5	24	22,05	•		•		1 1/16-12	26,95	25,00	1 1/4-11	41,91	38,90
26 x 1,5	26	24,05	•		•		1 1/16-14	26,95	25,30	1 1/2-11	47,80	44,90
30 x 1,5	30	28,05	•		•		1 5/16-12	33,30	31,30	2-11	59,62	56,70
30 x 2	30	27,40	•				1 5/16-14	33,30	31,60			
36 x 2	36	33,40	•				1 5/8-12	41,42	39,20			
38 x 1,5	38	36,05			•		1 5/8-14	41,22	39,50			
42 x 2	42	39,40	•				1 7/8-12	47,57	45,60			
45 x 1,5	45	43,05			•		1 7/8-14	47,57	45,90			
45 x 2	45	42,40	•				2 1/2-12	63,45	61,50			
52 x 1,5	52	50,05			•		3-12	76,20	74,30			
52 x 2	52	49,40	•									
65 x 2	65	64,40			•							
78 x 2	78	75,40			•							

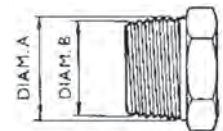

NPT Cónicas   NPT conique Conical NPT   NPT conico	Ø A	Ø B	BSPT Cónicas   BSPT conique Conical BSPT   BSPT conico	Ø A	Ø B
1/8-27	10,59	9,98	1/8-28	10,20	9,48
1/4-18	14,12	13,28	1/4-19	13,90	12,85
3/8-18	17,55	16,71	3/8-19	17,31	16,26
1/2-14	21,84	21,08	1/2-14	21,89	20,55
3/4-14	27,17	26,13	3/4-14	27,30	25,84
1-11,5	33,96	32,74	1-11	34,41	32,65
1 1/4-11,5	42,72	41,47	1 1/4-11	42,91	41,11
1 1/2-11,5	48,81	47,54	1 1/2-11	48,83	47,08
2-11,5	60,88	59,56	2-11	60,94	58,62

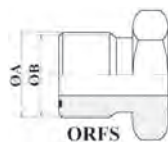

ORFS	Ø B (mm)	Ø A (mm)
9/16" 18h	13,0	14,25
11/16" 16h	15,4	17,40
13/16" 16h	18,6	20,05
1" 14h	23,1	25,30
1" 3/16 12h	27,5	30,10
1" 7/16 12h	33,8	36,40
1" 11/16 12h	40,2	42,80
2" 12h	48,1	50,70



Brida SAE	Ø Ext. 3000 PSI	Ø Ext. 6000 PSI
1/2"	30,2	31,8
3/4"	38,1	41,3
1"	44,5	47,6
1" 1/4	50,8	54,0
1" 1/2	60,3	63,5
2"	71,4	79,4

\* Las bridas 9000 PSI son iguales en Ø a las 6000 PSI, pero con espesor de pletina 14,3 | Les brides 9000 PSI son égales en Ø aux brides 6000 PSI, mais l'épaisseur est de 14,3 mm.  
 9000 PSI flanges have the same Ø as 6000 PSI, but with thickness deck 14,3 | Le flange 9000 PSI hanno il medesimo Ø della serie 6000 PSI, cambia unicamente lo spessore a 14,3 mm.



# Racores para tubería flexible

Embouts à sertir

**Flexible hose fittings**

Raccordi per tubi flessibili



Conexiones Standard CrIII	28
Embouts série Standard CrIII   Standard serie fittings CrIII   Raccordi serie Standard CrIII	
Conexiones Interlock CrIII	31
Embouts à sertir Interlock CrIII   Interlock serie fittings CrIII   Raccordi serie Interlock CrIII	
Conexiones Reusables CrIII	33
Embouts Récuperables CrIII   Reusable serie fittings CrIII   Raccordi serie Recuperabile CrIII	
Conexiones alta presión (700 Bar) CrIII	34
Embouts haute pression 700 Bar CrIII   High pressure 700 Bar fittings CrIII   Raccordi Altissima pressione (700 Bar) CrIII	
Conexiones Standard Zn/Ni	35
Embouts série Standard Zn/Ni   Standard serie fittings Zn/Ni   Raccordi serie Standard Zn/Ni	
Conexiones Interlock Zn/Ni	37
Embouts à sertir Interlock Zn/Ni   Interlock serie fittings Zn/Ni   Raccordi serie Interlock Zn/Ni	

# Serie Standard

Standard serie | Serie Standard | Standard serie

Hoses

Flexible hose fittings

Stainless steel hoses and fittings

Low pressure

Air conditioned hoses and fittings

Measuring flow

Machines for mounting flexibles

► **Una única conexión para una amplia gama de mangueras** | Un seul embout pour une grande gamme de tuyaux | One only fitting for a wide range of hoses | Un solo raccordo per una vasta gamma di tubi

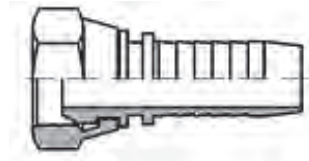

EN 857 1 SC	SUPERSERVICE 155° 1SC	SAE 100 R8 EN855	SAE 100 R7 EN855	Metallic Braid Elastomer	2 Metallic Braids Elastomer	SAE100 R4	SAE 100 R6	Smooth PTFE 1 Braid	Smooth PTFE 2 Braids	Convoluted PTFE
PF23... DI23... 21012...	PF2212... DI2212...	PF23... DI23... 21012...	PF23... DI23... 21012...	PF23... DI23... 21012...	PF1224... DI1224...	PF1224... DI1224... 22003...	PF23... DI23... 21012...	21040...	PF23... DI23... 21040...	21041...

EN 853 1ST SAE 100 R1A	EN 853 1 SN SAE 100 R1AT	EN 853 2SN SAE 100 R2AT	EN 857 2SC SAE 100 R16	SUPERSERVICE 155° 2SC	EN 853 2ST SAE 100 R2A	EN 856 4SP SAE100 R9R	EN 856 SAE 100 R12
22003...	PF2212... DI2212...	PF2212... DI2212...	PF2212... DI2212...	PF2212... DI2212...	PF1224... DI1224...	PF1224... DI1224...	PF1224... DI1224...

# Serie Interlock

Série interlock | Interlock serie | Serie Interlock

► **Una única conexión para toda la gama de mangueras de alta presión** | Un seul raccord pour tous les tubes de très haute pression | One only fitting for all very high pressure tubes | Un solo raccordo per tutti i tubi ad altissima pressione

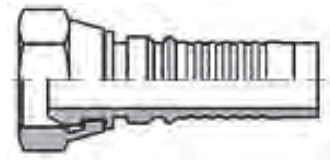

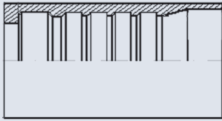
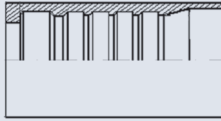
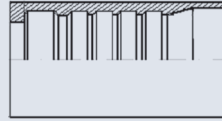
	EN856 4 SH	EN856 SAE100 R 13	EN856 SAE100 R 15	
	 A610... BA610...	 A610... 610...	 A610... 610...	

Hoses

Flexible hose fittings

Stainless steel hoses and fittings

Low pressure

Air conditioned hoses and fittings

Measuring flow

Machines for mounting flexibles

# Conexiones Standard CrIII

Embouts série Standard CrIII | Standard serie fittings CrIII | Raccordi serie Standard CrIII

Hoses

## Casquillos para prensar | Jupes à sertir | Crimping ferrules | Boccole a pressare

39

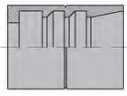

22003

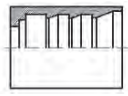

DI1224

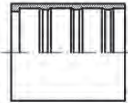

21040

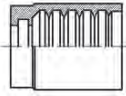

DI2212

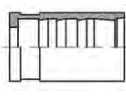

21012/DI2300

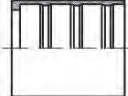

21041

Flexible hose fittings

## Conexiones BSP | Embouts BSP | BSP Fittings | Raccordi BSP

40



24100



24261



24110

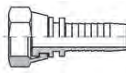

24200



24400



24107

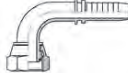

24117

Stainless steel hoses and fittings

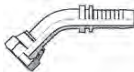

24108

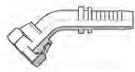

24118

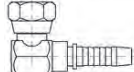

24127



24112



24212

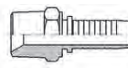

24114

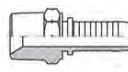

24161

Low pressure

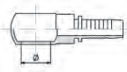

24111

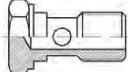

A1090

## Conexiones JIC 37° | Embouts JIC 37° | JIC 37° Fittings | Raccordi JIC 37°

43



24142



24242



24138

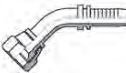

24139



24140

Air conditioned hoses and fittings

## Conexiones Métricas DIN 2353 | Embouts Métriques DIN 2353 | Metric fittings DIN 2353 | Raccordi Metrici DIN 2353

45

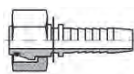

24804

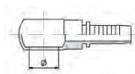

24116



24305

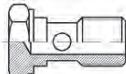

S1092

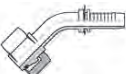

24306



24300

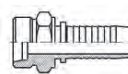

24203

Measuring flow



24190

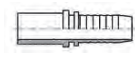

24158



24258



24358



24404

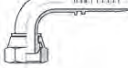

24405



24406

## Conexiones Métricas Serie Japonesa | Embouts Métriques Série Japonaise | Metric fittings Japanese Serie | Raccordi Metrici Serie Giapponese

48

Machines for mounting flexibles



2580496

▶ **Conexiones Métricas Serie Francesa** | Embouts Métriques Série Française | Metric fittings French Serie | Raccordi Metrici Serie Francese

49



24503

2450518

24504

24505

▶ **Conexiones ORFS** | Embouts ORFS | ORFS Fittings | Raccordi ORFS

50



44900

44912

44907

44908

JUNTAS

▶ **Bridas SAE 3000/6000 PSI** | Brides SAE 3000/6000 PSI | 3000/6000 PSI SAE Flanges | Flangia SAE 3000/6000 PSI

51



24182

24183

24184

24282

24283

24284

▶ **Bridas SAE** | Brides SAE | SAE Flanges | Flangia SAE

52

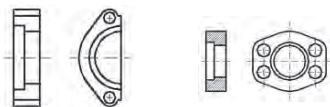

AFS

AFSI

▶ **Juntas para bridas** | Joints pour brides | Seals for flanges | O'Ring per flangia

52



JUNTAS

JBR

▶ **Bridas Caterpillar** | Embouts brides Caterpillar | 9000 PSI Caterpillar Flanges | Flangia Caterpillar

53



G44282

G44284

G44283

▶ **Pletinas de bridas Poclairn** | Embouts brides type Poclairn | Poclairn Flanges | Flangia Poclairn

54

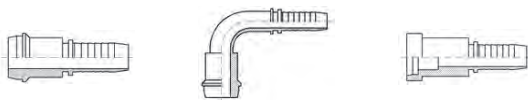

44801

44803

44802

▶ **Bridas Poclairn** | Brides Poclairn | Poclairn Flanges | Flangia Poclairn

54

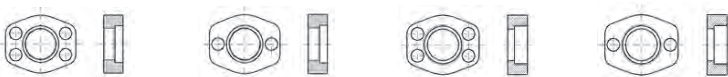

44805

44807

44806

44808

▶ **Racores para hidrolavadoras** | Embouts Karcher | Karcher fittings | Raccordi per idropulitrici



23040



23060



23061

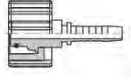

230700



23062

# Conexiones Interlock CrIII

Embouts à sertir Interlock CrIII | Interlock serie fittings CrIII | Raccordi serie Interlock CrIII

▶ **Casquillos** | Jupes | Crimp ferrules | Boccole a pressare

56

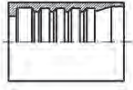

BA610

▶ **Conexiones BSP** | Embouts BSP | BSP Fittings | Raccordi BSP

56



B64100

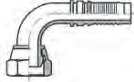

B64107

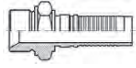

B64112

▶ **Conexiones JIC 37°** | Embouts JIC 37° | JIC 37° Fittings | Raccordi JIC 37°

56



B64142

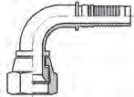

B64138

▶ **Conexiones Métricas DIN 2353** | Embouts Métriques DIN 2353 | Metric fittings DIN 2353 | Raccordi Metrici DIN 2353

57

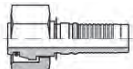

B64204

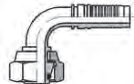

B64205

▶ **Racores para martillo** | Embouts pour marteau | Fittings for hammer | Raccordi per martello

57

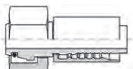

NAM

▶ **Bridas 3000 PSI** | Embouts brides SAE 3000 PSI | 3000 PSI SAE flange | Flangia SAE 3000 PSI

57

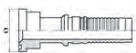

B64182

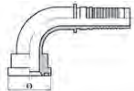

B64183

▶ **Bridas 6000 PSI** | Embouts brides SAE 6000 PSI | 6000 PSI SAE flange | Flangia SAE 6000 PSI

57

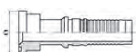

B64282

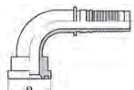

B64283

Hoses

Flexible hose fittings

Stainless steel hoses and fittings

Low pressure

Air conditioned hoses and fittings

Measuring flow

Machines for mounting flexibles



**Bridas Poclairn** | Embouts brides Poclairn | Poclairn Flanges | Flangia Poclairn



64801

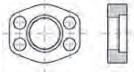

44805



64802



44806

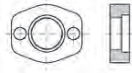

44807



44808

# Conexiones Reusables CrIII

Embouts Récuperables CrIII | Reusable serie fittings CrIII | Raccordi serie Recuperabile CrIII

## Casquillos | Jupes | Ferrules | Boccole recuperabili

59

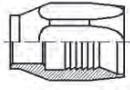

A1G-...R1

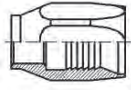

A1G-...R1T

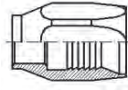

A1G-...R2

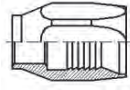

A1G-...R2T

## Conexiones | Embouts | Fittings | Raccordi recuperabili

59



A3G



A90G

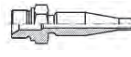

A2G



S2G



AE

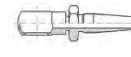

AOG

Hoses

Flexible hose fittings

Stainless steel hoses and fittings

Low pressure

Air conditioned hoses and fittings

Measuring flow

Machines for mounting flexibles

## Conexiones alta presión (700 Bar) CrIII

Embouts haute pression 700 Bar CrIII | High pressure 700 Bar fittings CrIII | Raccordi Altissima pressione (700 Bar) CrIII

### Casquillos | Jupes à sertir | Ferrules | Boccole

61



M3520

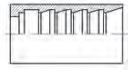

71012

### Conexiones BSP | Embouts BSP | BSP Fittings | Raccordi BSP

61



74100



74112



74161

### Conexiones JIC 37° | Embouts JIC 37° | JIC 37° Fittings | Raccordi JIC 37°

61



74142

# Conexiones Standard Zn/Ni

Embouts série Standard Zn/Ni | Standard serie fittings Zn/Ni | Raccordi serie Standard Zn/Ni

▶ **Casquillos para prensar** | Jupes à sertir | Crimping ferrules | Boccole a pressare 63

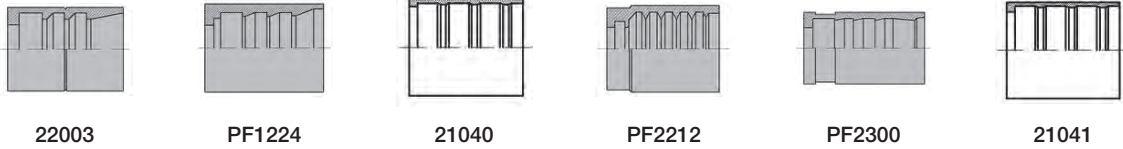

22003      PF1224      21040      PF2212      PF2300      21041

▶ **Conexiones BSP** | Embouts BSP | BSP Fittings | Raccordi BSP 64



G24110      G24117      G24118      G24112      G24212      G24114      G24161

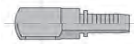

G24111

▶ **Conexiones JIC 37°** | Embouts JIC 37° | JIC 37° Fittings | Raccordi JIC 37° 65



G24140      G24142      G24138      G24139

▶ **Conexiones Métricas DIN 2353** | Embouts Métriques DIN 2353 | Metric fittings DIN 2353 | Raccordi Metrici DIN 2353 67

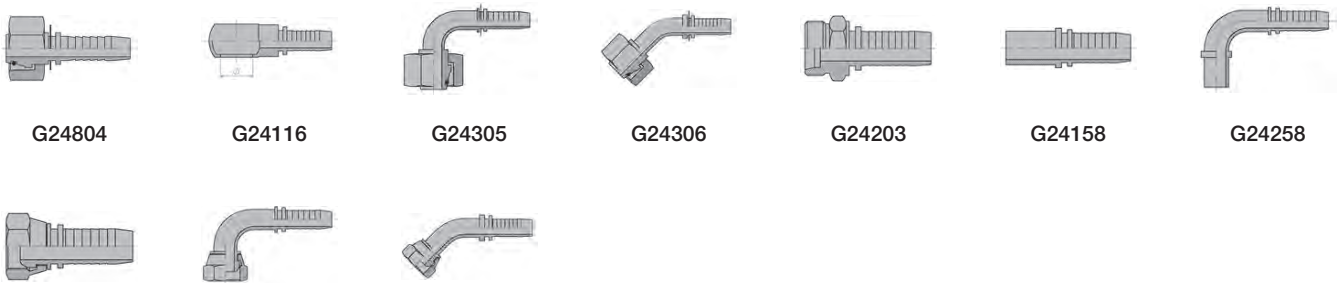

G24804      G24116      G24305      G24306      G24203      G24158      G24258

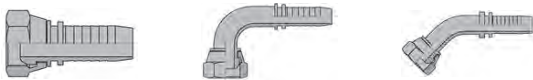

G24404      G24405      G24406

▶ **Conexiones ORFS** | Embouts ORFS | ORFS Fittings | Raccordi ORFS 70



G44900      G44912      G44907      G44908

▶ **Bridas SAE 3000/6000 PSI** | Brides SAE 3000/6000 PSI | 3000/6000 PSI SAE Flanges | Flangia SAE 3000/6000 PSI 71



G24182      G24183      G24184      G24282      G24283      G24284

► **Bridas Caterpillar** | Embouts brides Caterpillar | 9000 PSI Caterpillar Flanges | Flangia Caterpillar

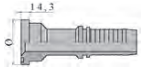

44282



44284



44283

# Conexiones Interlock Zn/Ni

Embouts à sertir Interlock Zn/Ni | Interlock serie fittings Zn/Ni | Raccordi serie Interlock Zn/Ni

▶ **Casquillos** | Jupes | Crimping ferrules | Boccole a pressare

73

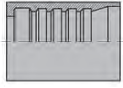

A61010



61010

▶ **Conexiones BSP** | Embouts BSP | BSP Fittings | Raccordi BSP

73



64100

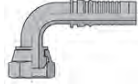

64107



64108

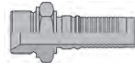

64112



64161

▶ **Conexiones JIC 37°** | Embouts JIC 37° | JIC 37° Fittings | Raccordi JIC 37°

74



64142



64139

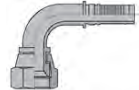

64138



64140

▶ **Conexiones Métricas DIN 2353** | Embouts Métriques DIN 2353 | Metric fittings DIN 2353 | Raccordi Metrici DIN 2353

75

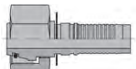

64204



64206



64205



64203

▶ **Conexiones ORFS** | Embouts ORFS | ORFS fittings | Raccordi ORFS

75



64900

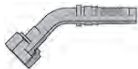

64908

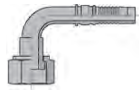

64907

▶ **Bridas SAE 3000/6000 PSI** | Embouts brides SAE 3000/6000 PSI | 3000/6000 PSI SAE Flanges | Flangia SAE 3000/6000 PSI

76



64182



64183



64184

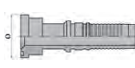

64282



64283



64284

▶ **Bridas Caterpillar** | Embouts brides Caterpillar | 9000 PSI Caterpillar flanges | Flangia Caterpillar 9000 PSI

77



64382



64384



64383

Hoses

Flexible hose fittings

Stainless steel hoses and fittings

Low pressure

Air conditioned hoses and fittings

Measuring flow

Machines for mounting flexibles



## Conexiones Standard CrIII

Embouts série Standard CrIII  
Standard serie fittings CrIII  
Raccordi serie Standard CrIII

### Casquillos R1A/1ST

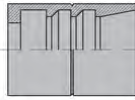

Jupes à sertir pour R1A/1ST  
Ferrules R1A/1ST  
Boccole a pressare per R1A/1ST

DN	REFERENCIA PART N°	€
3/16"	220030300	*
1/4"	220030400	*
5/16"	220030500	*
3/8"	220030600	*
1/2"	220030800	*
5/8"	220031000	*
3/4"	220031200	*
1"	220031600	*
1"1/4	220032000	*
1"1/2	220032400	*
2"	220033200	*

Ver precios en p.63 (Conexiones Standard Zn/Ni) // Prix à la p.63 (Embouts Série Standard Zn/Ni) // See prices in p.63 (Standard Serie Fittings Zn/Ni) // Vedere prezzi p.63 (Raccordi Serie Standard Zn/Ni)

### Casquillos R1AT/ R2AT/1SN/2SN/2SC

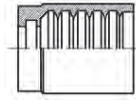

Jupes à sertir R1AT/R2AT/1SN/2SN/2SC  
Ferrules R1AT/R2AT/1SN/2SN/2SC  
Boccole a pressare per R1AT/R2AT/1SN/2SN/2SC

DN	REFERENCIA PART N°	€
3/16"	DI221200300	1,27
1/4"	DI221200400	0,95
5/16"	DI221200500	1,18
3/8"	DI221200600	1,09
1/2"	DI221200800	1,48
5/8"	DI221201000	2,39
3/4"	DI221201200	2,61
1"	DI221201600	4,35
1"1/4	DI221202000	10,73
1"1/2	DI221202400	14,38
2"	DI221203200	23,59

### Casquillos R2A/R9R/2ST/4SP

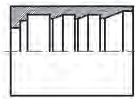

Jupes à sertir R2A/R9R/2ST/4SP  
Ferrules R2A/R9R/2ST/4SP  
Boccole a pressare per R2A/R9R/2ST/4SP

DN	REFERENCIA PART N°	€
3/16"	DI122400300	1,61
1/4"	DI122400400	1,04
5/16"	DI122400500	1,29
3/8"	DI122400600	1,37
1/2"	DI122400800	1,76
5/8"	DI122401000	2,54
3/4"	DI122401200	3,29
1"	DI122401600	5,14
1"1/4	DI122402000	10,32
1"1/2	DI122402400	14,67
2"	DI122403200	24,22

### Casquillos R7, R8 y malla metálica

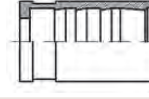

Jupes à sertir R7, R8 et tresse métallique  
Ferrules SAE 100 R7, R8 and metallic braid  
Boccole a pressare per SAE R7, R8 e Treccia Metallica

DN	REFERENCIA PART N°	€
1/8"	210120200	1,48
3/16"	DI2300300	0,94
1/4"	DI2300400	1,00
5/16"	DI2300500	1,20
3/8"	DI2300600	1,23
1/2"	DI2300800	1,65
5/8"	210121000	3,42
3/4"	210121200	3,72
1"	210121600	7,06

### Casquillos Teflón Liso alta presión

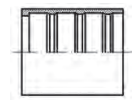

Jupes à sertir pour Teflon Lisse haute pression  
Ferrules for Smooth PTFE  
Boccole a pressare per tubo al Teflon Liscio alta pressione

DN	REFERENCIA PART N°	€
3/16"	210400300	1,62
1/4"	210400400	1,19
5/16"	210400500	1,54
3/8"	210400600	1,35
1/2"	210400800	1,66
5/8"	210401000	2,06
3/4"	210401200	2,61
1"	210401600	4,47

### Casquillos Teflón Coarrugado alta presión

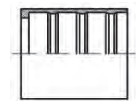

Jupes à sertir Teflon Convoluté haute pression  
Ferrules for Convoluted PTFE  
Boccole a pressare per tubo al Teflon Coarrugado alta pressione

DN	REFERENCIA PART N°	€
1/4"	210410400	1,48
3/8"	210410600	1,83
1/2"	210410800	1,90
5/8"	210411000	2,88
3/4"	210411200	3,09
1"	210411600	4,99
1"1/4	210412000	8,92
1"1/2	210412400	12,36
2"	210413200	20,27



## Conexiones Standard CrIII

Embouts série Standard CrIII

Standard serie fittings CrIII

Raccordi serie Standard CrIII

Hoses

Flexible hose fittings

Stainless steel hoses and fittings

Low pressure

Air conditioned hoses and fittings

Measuring flow

Machines for mounting flexibles

### Hembras giratorias rectas BSP cono 60°

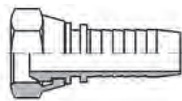

Femelle tournante gaz cyl BSP 60°

BSP Swivel female 60° cone

Femmina diritta BSP sede 60°

DN	ROSCA THREAD	REFERENCIA PART N°	€
1/8"	1/8" BSP	241000202	1,57
3/16"	1/8" BSP	241000203	1,10
1/4"	1/8" BSP	241000204	1,34
3/16"	1/4" BSP	241000403	1,73
1/4"	1/4" BSP	241000404	1,15
5/16"	1/4" BSP	241000405	1,92
3/8"	1/4" BSP	241000406	1,89
1/4"	3/8" BSP	241000604	1,82
5/16"	3/8" BSP	241000605	1,62
3/8"	3/8" BSP	241000606	1,42
1/2"	3/8" BSP	241000608	2,20
1/4"	1/2" BSP	241000804	2,36
3/8"	1/2" BSP	241000806	2,23
1/2"	1/2" BSP	241000808	2,09
5/8"	1/2" BSP	241000810	3,15
1/2"	5/8" BSP	241001008	3,23
5/8"	5/8" BSP	241001010	3,15
1/2"	3/4" BSP	241001208	3,93
5/8"	3/4" BSP	241001210	3,93
3/4"	3/4" BSP	241001212	3,52
3/4"	1" BSP	241001612	7,23
1"	1" BSP	241001616	6,73

Para aquellas mayores de 1" ver con junta // Pour ceux plus grand que 1" voir avec o'ring  
// For those bigger than 1" see with o'ring // Per quelli più grandi di 1" vedere con o'ring

### Hembras giratorias NPSM



Femelle tournante NPSM

NPSM swivel female

Femmina diritta NPSM

DN	ROSCA THREAD	REFERENCIA PART N°	€
1/4 "	1/4" 18h NPSM	242610404	*
3/8 "	3/8" 18h NPSM	242610606	*
1/2"	1/2" 14h NPSM	242610808	*
3/4 "	3/4" 14h NPSM	242611212	*
1"	1" - 11 1/2 h NPSM	242611616	*

### Hembras giratorias rectas BSP cono 60° con junta tórica

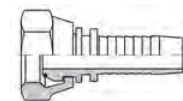

Femelle tournante droit gaz cyl BSP 60° + o'ring

BSP Swivel female 60° with o'ring

Femmina diritta BSP sede 60° con o'ring

DN	ROSCA THREAD	REFERENCIA PART N°	€
1/4"	1/4" BSP	241100404	2,18
3/8"	3/8" BSP	241100606	1,82
1/2"	1/2" BSP	241100808	2,80
5/8"	5/8" BSP	241101010	12,21
5/8"	3/4" BSP	241101210	4,50
3/4"	3/4" BSP	241101212	3,86
1"	1" BSP	241101616	8,72
1"	1" 1/4 BSP	241102016	13,90
1" 1/4"	1" 1/4 BSP	241102020	14,55
1" 1/4"	1" 1/2 BSP	241102420	31,92
1" 1/2"	1" 1/2 BSP	241102424	18,91
1" 1/2"	2" BSP	241103224	53,26
2"	2" BSP	241103232	34,33

### Hembras giratorias rectas BSP asiento plano

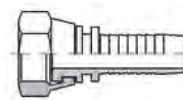

Femelle tournante fond plat BSP

BSP Swivel female flat seat

Femmina diritta BSP sede piana

DN	ROSCA THREAD	REFERENCIA PART N°	€
1/4"	1/4" BSP	242000404	1,50
5/16"	3/8" BSP	242000605	2,89
3/8"	3/8" BSP	242000606	2,05
3/8"	1/2" BSP	242000806	3,23
1/2"	1/2" BSP	242000808	3,54
1/2"	3/4" BSP	242001208	7,52
3/4"	3/4" BSP	242001212	5,19
1"	1" BSP	242001616	8,50
1" 1/4"	1" 1/4 BSP	242002020	15,74
1" 1/2"	1" 1/2 BSP	242002424	20,66

### Hembras giratorias BSP 60° doble hexagono



Femelle tournante BSP cône 60° double hexagonal

BSP Swivel female 60° cone double hex.

Femmina diritta BSP sede 60° doppio esagono

DN	ROSCA THREAD	REFERENCIA PART N°	€
1/4"	1/4" BSP	244000404	2,25
5/16"	3/8" BSP	244000605	2,67
3/8"	3/8" BSP	244000606	2,67
1/2"	1/2" BSP	244000808	3,42
3/4"	3/4" BSP	244001212	6,74
1"	1" BSP	244001616	9,62
1" 1/4"	1" 1/4 BSP	244002020	20,31
1" 1/2"	1" 1/2 BSP	244002424	31,01
2"	2" BSP	244003232	51,32

## Conexiones Standard CrIII

Embouts série Standard CrIII  
Standard serie fittings CrIII  
Raccordi serie Standard CrIII

### Hembras giratorias 90° BSP cono 60°

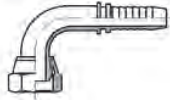

Coude 90° femelle tournante gaz cyl BSP 60°  
90° BSP Swivel female 60° cone  
Femmina a 90° BSP sede 60°

DN	ROSCA THREAD	REFERENCIA PART N°	€
3/16"	1/8" BSP	241070203	2,28
1/4"	1/8" BSP	241070204	1,73
3/16"	1/4" BSP	241070403	2,13
1/4"	1/4" BSP	241070404	1,75
1/4"	3/8" BSP	241070604	2,79
5/16"	3/8" BSP	241070605	2,68
3/8"	3/8" BSP	241070606	2,65
1/4"	1/2" BSP	241070804	4,13
3/8"	1/2" BSP	241070806	3,55
1/2"	1/2" BSP	241070808	3,57
1/2"	5/8" BSP	241071008	9,18
5/8"	5/8" BSP	241071010	6,58
1/2"	3/4" BSP	241071208	6,62
5/8"	3/4" BSP	241071210	7,17
3/4"	3/4" BSP	241071212	5,89
3/4"	1" BSP	241071612	10,88
1"	1" BSP	241071616	10,25

Para aquellas mayores de 1" ver con junta // Pour ceux plus grand que 1" voir avec o'ring  
// For those bigger than 1" see with o'ring // Per quelli più grandi di 1" vedere con o'ring

### Hembras giratorias 90° BSP cono 60° con junta tórica

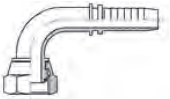

Coude 90° femelle tournante gaz cyl BSP 60° + o'ring  
90° BSP Swivel female 60° cone with o'ring  
Femmina a 90° BSP sede 60° con o'ring

DN	ROSCA THREAD	REFERENCIA PART N°	€
1/4"	1/4" BSP	241170404	4,56
3/8"	3/8" BSP	241170606	5,10
1/2"	1/2" BSP	241170808	7,01
5/8"	5/8" BSP	241171010	26,63
3/4"	3/4" BSP	241171212	13,22
1"	1" BSP	241171616	22,74
1"	1"1/4 BSP	241172016	27,44
1"1/4	1"1/4 BSP	241172020	27,87
1"1/4	1"1/2 BSP	241172420	64,52
1"1/2	1"1/2 BSP	241172424	31,48
2"	2" BSP	241173232	85,35

### Hembras giratorias 45° BSP cono 60°

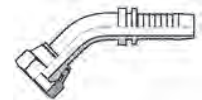

Coude 45° femelle tournante gaz cyl BSP 60°  
45° BSP Swivel female 60° cone  
Femmina a 45° BSP sede 60°

DN	ROSCA THREAD	REFERENCIA PART N°	€
3/16"	1/8" BSP	241080203	5,60
1/4"	1/8" BSP	241080204	7,09
3/16"	1/4" BSP	241080403	5,86
1/4"	1/4" BSP	241080404	2,28
1/4"	3/8" BSP	241080604	2,52
5/16"	3/8" BSP	241080605	4,81
3/8"	3/8" BSP	241080606	2,91
3/8"	1/2" BSP	241080806	4,33
1/2"	1/2" BSP	241080808	3,91
1/2"	5/8" BSP	241081008	10,19
5/8"	5/8" BSP	241081010	8,12
5/8"	3/4" BSP	241081210	11,14
3/4"	3/4" BSP	241081212	7,42
3/4"	1" BSP	241081612	18,27
1"	1" BSP	241081616	13,16

Para aquellas mayores de 1" ver con junta // Pour ceux plus grand que 1" voir avec o'ring  
// For those bigger than 1" see with o'ring // Per quelli più grandi di 1" vedere con o'ring

### Hembras giratorias 45° BSP cono 60° con junta tórica



Coude 45° femelle tournante gaz cyl BSP 60° + o'ring  
45° BSP Swivel female 60° cone with o'ring  
Femmina a 45° BSP sede 60° con o'ring

DN	ROSCA THREAD	REFERENCIA PART N°	€
1/4"	1/4" BSP	241180404	4,21
3/8"	3/8" BSP	241180606	5,41
1/2"	1/2" BSP	241180808	6,83
5/8"	5/8" BSP	241181010	27,09
5/8"	3/4" BSP	241181210	10,72
3/4"	3/4" BSP	241181212	11,43
1"	1" BSP	241181616	17,14
1"	1"1/4 BSP	241182016	44,08
1"1/4	1"1/4 BSP	241182020	24,16
1"1/2	1"1/2 BSP	241182424	19,91
1"1/2	2" BSP	241183224	123,05
2"	2" BSP	241183232	39,90

### Hembras giratorias 90° BSP cono 60° (compactas)

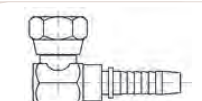

Coude 90° femelle tournante compact gaz cyl BSP 60°  
90° BSP Swivel female 60° cone (compact)  
Femmina a 90° BSP sede 60° (compatta)

DN	ROSCA THREAD	REFERENCIA PART N°	€
1/4"	1/4" BSP	241270404	3,54
3/8"	3/8" BSP	241270606	4,64
1/2"	1/2" BSP	241270808	5,82
3/4"	3/4" BSP	241271212	13,22

## Conexiones Standard CrIII

Embouts série Standard CrIII  
Standard serie fittings CrIII  
Raccordi serie Standard CrIII

Hoses

Flexible hose fittings

Stainless steel hoses and fittings

Low pressure

Air conditioned hoses and fittings

Measuring flow

Machines for mounting flexibles

### Macho rosca cilíndrica BSP cono 60°



Mâle fixe gaz cyl BSP 60°  
BSP Male parallel 60° cone  
Maschio BSP cilindrico sede 60°

DN	ROSCA THREAD	REFERENCIA PART N°	€
3/16"	1/8" BSP	241120203	1,18
1/4"	1/8" BSP	241120204	1,34
1/8"	1/4" BSP	241120402	6,81
3/16"	1/4" BSP	241120403	3,55
1/4"	1/4" BSP	241120404	1,38
3/8"	1/4" BSP	241120406	2,64
1/4"	3/8" BSP	241120604	2,28
5/16"	3/8" BSP	241120605	2,11
3/8"	3/8" BSP	241120606	1,75
1/2"	3/8" BSP	241120608	2,36
1/4"	1/2" BSP	241120804	2,68
3/8"	1/2" BSP	241120806	2,37
1/2"	1/2" BSP	241120808	2,45
1/2"	5/8" BSP	241121008	8,63
5/8"	5/8" BSP	241121010	4,09
1/2"	3/4" BSP	241121208	4,64
5/8"	3/4" BSP	241121210	5,02
3/4"	3/4" BSP	241121212	4,32
3/4"	1" BSP	241121612	9,75
1"	1" BSP	241121616	7,20
1"	1"1/4 BSP	241122016	27,09
1"1/4"	1"1/4 BSP	241122020	16,19
1"1/2"	1"1/2 BSP	241122424	19,67
2"	2" BSP	241123232	42,19

### Macho rosca cónica BSPT

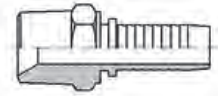

Mâle fixe gaz conique BSPT  
BSPT Male tapered  
Maschio BSPT conico

DN	ROSCA THREAD	REFERENCIA PART N°	€
3/16"	1/8" BSPT	241140203	2,98
1/4"	1/8" BSPT	241140204	1,18
1/4"	1/4" BSPT	241140404	1,18
1/4"	3/8" BSPT	241140604	1,86
5/16"	3/8" BSPT	241140605	1,86
3/8"	3/8" BSPT	241140606	1,73
3/8"	1/2" BSPT	241140806	2,28
1/2"	1/2" BSPT	241140808	2,58
5/8"	3/4" BSPT	241141210	10,47
3/4"	3/4" BSPT	241141212	3,93
3/4"	1" BSPT	241141612	13,68
1"	1" BSPT	241141616	9,29
1"	1"1/4 BSPT	241142016	24,34
1"1/4"	1"1/4 BSPT	241142020	17,56
1"1/2"	1"1/2 BSPT	241142424	17,31
2"	2" BSPT	241143232	43,38

### Macho rosca cilíndrica BSP asiento plano

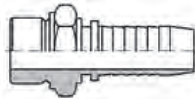

Mâle fixe gaz cyl fond plat  
BSP Male flat seat  
Maschio BSP cilindrico sede piana

DN	ROSCA THREAD	REFERENCIA PART N°	€
1/4"	1/4" BSP	242120404	3,41
3/8"	3/8" BSP	242120606	4,45
3/8"	1/2" BSP	242120806	4,70
1/2"	1/2" BSP	242120808	5,18

### Macho rosca cónica NPT

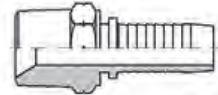

Mâle fixe gaz conique NPT  
NPT Male thread  
Maschio NPT conico

DN	ROSCA THREAD	REFERENCIA PART N°	€
3/16"	1/8" NPT	241610203	2,76
1/4"	1/8" NPT	241610204	2,30
1/4"	1/4" NPT	241610404	1,44
1/4"	3/8" NPT	241610604	2,18
5/16"	3/8" NPT	241610605	2,18
3/8"	3/8" NPT	241610606	2,23
1/2"	3/8" NPT	241610608	3,62
3/8"	1/2" NPT	241610806	2,65
1/2"	1/2" NPT	241610808	2,65
5/8"	1/2" NPT	241610810	5,44
1/2"	3/4" NPT	241611208	10,80
3/4"	3/4" NPT	241611212	3,90
3/4"	1" NPT	241611612	11,94
1"	1" NPT	241611616	7,25
1"	1"1/4 NPT	241612016	21,12
1"1/4"	1"1/4 NPT	241612020	14,67
1"1/2"	1"1/2 NPT	241612424	19,50
2"	2" NPT	241613232	37,15

## Conexiones Standard CrIII

Embouts série Standard CrIII  
Standard serie fittings CrIII  
Raccordi serie Standard CrIII

### Orientable BSP

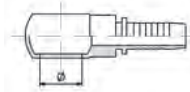

Embout Banjo droit gaz  
Banjo BSP  
Raccordo ad occhio BSP

DN	Ø	REFERENCIA PART N°	€
3/16"	1/4" BSP	241110403	2,91
1/4"	1/4" BSP	241110404	2,05
5/16"	1/4" BSP	241110405	2,83
3/8"	1/4" BSP	241110406	2,83
1/4"	3/8" BSP	241110604	3,06
5/16"	3/8" BSP	241110605	3,20
3/8"	3/8" BSP	241110606	2,97
1/2"	3/8" BSP	241110608	3,20
3/8"	1/2" BSP	241110806	5,19
1/2"	1/2" BSP	241110808	5,19
5/8"	5/8" BSP	241111010	26,88
1/2"	3/4" BSP	241111208	8,84
5/8"	3/4" BSP	241111210	11,33
3/4"	3/4" BSP	241111212	11,49
1"	1" BSP	241111616	23,21

### Tornillo orientable simple BSP

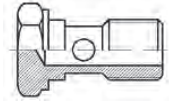

Vis creuse simple pour banjo filetage gaz BSP  
BSP bolt for Banjo  
Bullone forato BSP

ROSCA THREAD	REFERENCIA PART N°	€
1/8" BSP	A109002	*
1/4" BSP	A109004	*
3/8" BSP	A109006	*
1/2" BSP	A109008	*
3/4" BSP	A109012	*
1" BSP	A109016	*
1" 1/4 BSP	A109020	*
1" 1/2 BSP	A109024	*

Ver precios en p.243 (ADAPTADORES BSP) // Prix à la p.243 (ADAPTEURS BSP) //  
See prices in p.243 (BSP ADAPTORS) // Vedere prezzi p.243 (ADATTATORI BSP)

### Hembras giratorias rectas JIC 37°



Femelle tournante droite JIC cône 37°  
JIC Swivel female 37° cone  
Femmina diritta JIC 37°

DN	ROSCA THREAD	REFERENCIA PART N°	€
3/16"	7/16" 20h UNF	241420703	1,73
1/4"	7/16" 20h UNF	241420704	1,35
1/4"	1/2" 20h UNF	241420804	1,35
5/16"	1/2" 20h UNF	241420805	1,89
1/4"	9/16" 18h UNF	241420904	1,42
5/16"	9/16" 18h UNF	241420905	1,35
3/8"	9/16" 18h UNF	241420906	1,42
3/8"	5/8" 18h UNF	241421006	2,36
5/16"	3/4" 16h UNF	241421205	2,36
3/8"	3/4" 16h UNF	241421206	2,16
1/2"	3/4" 16h UNF	241421208	2,02
3/8"	7/8" 14h UNF	241421406	2,83
1/2"	7/8" 14h UNF	241421408	2,77
5/8"	7/8" 14h UNF	241421410	3,04
1/2"	1"1/16 12h UNF	241421708	4,33
5/8"	1"1/16 12h UNF	241421710	4,20
3/4"	1"1/16 12h UNF	241421712	4,05
1"	1"1/16 12h UNF	241421716	7,24
3/4"	1"5/16 12h UNF	241422112	7,76
1"	1"5/16 12h UNF	241422116	7,76
1"	1"5/8 12h UNF	241422616	17,94
1"1/4	1"5/8 12h UNF	241422620	13,82
1"1/4	1"7/8 12h UNF	241423020	34,67
1"1/2	1"7/8 12h UNF	241423024	19,28
2"	2"1/2 12h UNF	241424032	33,05

### Hembras giratorias rectas JIC 37° doble hexagono



Femelle JIC 37° double hexagonal  
JIC swivel female 37° cone double hex.  
Femmina diritta JIC 37° doppio esagono

DN	ROSCA THREAD	REFERENCIA PART N°	€
1/4"	7/16" 20h UNF	242420704	1,97
1/4"	1/2" 20h UNF	242420804	2,16
5/16"	9/16" 18h UNF	242420905	2,66
3/8"	9/16" 18h UNF	242420906	2,66
3/8"	3/4" 16h UNF	242421206	2,95
1/2"	3/4" 16h UNF	242421208	3,44
1/2"	7/8" 14h UNF	242421408	3,93
3/4"	1"1/16 12h UN	242421712	5,90
1"	1"5/16 12h UN	242422116	9,05
1"1/4	1"5/8 12h UN	242422620	19,18
1"1/2	1"7/8 12h UN	242423024	29,51
2"	2"1/2 12h UN	242424032	49,18

## Conexiones Standard CrIII

Embouts série Standard CrIII  
Standard serie fittings CrIII  
Raccordi serie Standard CrIII

Hoses

Flexible hose fittings

Stainless steel hoses  
and fittings

Low pressure

Air conditioned hoses  
and fittings

Measuring flow

Machines for  
mounting flexibles

### Hembras giratorias 90° JIC 37°

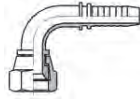

Coude 90° femelle tournante cône JIC 37°  
90° JIC Swivel female 37° cone  
Femmina a 90° JIC 37°

DN	ROSCA THREAD	REFERENCIA PART N°	€
3/16"	7/16" 20h UNF	241380703	4,19
1/4"	7/16" 20h UNF	241380704	2,00
1/4"	1/2" 20h UNF	241380804	3,23
1/4"	9/16" 18h UNF	241380904	2,76
5/16"	9/16" 18h UNF	241380905	3,73
3/8"	9/16" 18h UNF	241380906	2,91
3/8"	5/8" 18h UNF	241381006	5,63
3/8"	3/4" 16h UNF	241381206	3,62
1/2"	3/4" 16h UNF	241381208	3,78
3/8"	7/8" 14h UNF	241381406	7,06
1/2"	7/8" 14h UNF	241381408	5,12
5/8"	7/8" 14h UNF	241381410	7,44
1/2"	1"1/16 12h UNF	241381708	13,32
5/8"	1"1/16 12h UNF	241381710	7,87
3/4"	1"1/16 12h UNF	241381712	7,04
3/4"	1"5/16 12h UNF	241382112	14,88
1"	1"5/16 12h UNF	241382116	14,01
1"	1"5/8 12h UNF	241382616	24,59
1"1/4	1"5/8 12h UNF	241382620	33,76
1"1/4	1"7/8 12h UNF	241383020	58,66
1"1/2	1"7/8 12h UNF	241383024	34,43
2"	2"1/2 12h UNF	241384032	117,34

### Hembras giratorias 45° JIC 37°

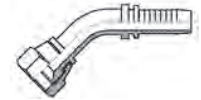

Coude 45° femelle tournante cône JIC 37°  
45° JIC swivel female 37° cone  
Femmina a 45° JIC 37°

DN	ROSCA THREAD	REFERENCIA PART N°	€
1/4"	7/16" 20h UNF	241390704	3,25
1/4"	1/2" 20h UNF	241390804	3,99
1/4"	9/16" 18h UNF	241390904	3,82
5/16"	9/16" 18h UNF	241390905	5,20
3/8"	9/16" 18h UNF	241390906	3,82
3/8"	3/4" 16h UNF	241391206	4,74
1/2"	3/4" 16h UNF	241391208	5,58
1/2"	7/8" 14h UNF	241391408	6,92
5/8"	7/8" 14h UNF	241391410	8,10
1/2"	1"1/16 12h UNF	241391708	14,93
5/8"	1"1/16 12h UNF	241391710	10,19
3/4"	1"1/16 12h UNF	241391712	13,54
3/4"	1"5/16 12h UNF	241392112	18,33
1"	1"5/16 12h UNF	241392116	17,70
1"	1"5/8 12h UNF	241392616	26,86
1"1/4	1"5/8 12h UNF	241392620	36,24
1"1/4	1"7/8 12h UNF	241393020	60,19
1"1/2	1"7/8 12h UNF	241393024	61,21
2"	2"1/2 12h UNF	241394032	117,34

### Macho JIC 37°



Mâle fixe JIC cône 37°  
Male JIC 37° cone  
Maschio JIC 37°

DN	ROSCA THREAD	REFERENCIA PART N°	€
1/4"	7/16" 20h UNF	241400704	1,10
1/4"	1/2" 20h UNF	241400804	2,03
1/4"	9/16" 18h UNF	241400904	1,57
5/16"	9/16" 18h UNF	241400905	1,79
3/8"	9/16" 18h UNF	241400906	1,57
3/8"	3/4" 16h UNF	241401206	2,13
1/2"	3/4" 16h UNF	241401208	2,36
3/8"	7/8" 14h UNF	241401406	3,02
1/2"	7/8" 14h UNF	241401408	2,55
5/8"	7/8" 14h UNF	241401410	3,12
1/2"	1"1/16 12h UNF	241401708	7,42
5/8"	1"1/16 12h UNF	241401710	4,23
3/4"	1"1/16 12h UNF	241401712	4,55
3/4"	1"5/16 12h UNF	241402112	7,25
1"	1"5/16 12h UNF	241402116	9,10
1"	1"5/8 12h UNF	241402616	16,85
1"1/4	1"5/8 12h UNF	241402620	18,64
1"1/4	1"7/8 12h UNF	241403020	28,01
1"1/2	1"7/8 12h UNF	241403024	32,40
2"	2"1/2 12h UNF	241404032	47,75

## Conexiones Standard CrIII

Embouts série Standard CrIII  
Standard serie fittings CrIII  
Raccordi serie Standard CrIII

### Hembras giratorias Métricas cono 24° con junta tórica

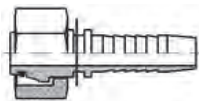

Femelle tournante Métrique cône 24° + o'ring Série Allemande

Metric swivel female 24° cone with o'ring

Femmina Metrica sede 24° con o'ring

DN	TUBO PIPE	SERIE	ROSCA THREAD	REFERENCIA PART N°	€
3/16"	6	L	12X1,5	24804120603	1,81
1/4"	6	L	12X1,5	24804120604	1,36
1/4"	8	L	14X1,5	24804140804	1,24
1/4"	10	L	16X1,5	24804161004	1,42
5/16"	10	L	16X1,5	24804161005	1,75
3/8"	10	L	16X1,5	24804161006	1,89
1/4"	12	L	18X1,5	24804181204	1,89
5/16"	12	L	18X1,5	24804181205	1,71
3/8"	12	L	18X1,5	24804181206	1,60
3/8"	15	L	22X1,5	24804221506	2,71
1/2"	15	L	22X1,5	24804221508	2,16
1/2"	18	L	26X1,5	24804261808	3,65
5/8"	18	L	26X1,5	24804261810	3,27
3/4"	22	L	30X2	24804302212	4,30
1"	28	L	36X2	24804362816	8,14
1" 1/4	35	L	45X2	24804453520	12,45
1" 1/2	42	L	52X2	24804524224	20,72
3/16"	8	S	16X1,5	24804160803	2,13
1/4"	8	S	16X1,5	24804160804	1,67
1/4"	10	S	18X1,5	24804181004	1,62
5/16"	12	S	20X1,5	24804201205	1,67
3/8"	12	S	20X1,5	24804201206	1,96
3/8"	14	S	22X1,5	24804221406	2,68
1/2"	16	S	24X1,5	24804241608	2,97
5/8"	20	S	30X2	24804302010	4,41
3/4"	20	S	30X2	24804302012	5,27
3/4"	25	S	36X2	24804362512	8,16
1"	25	S	36X2	24804362516	11,41
1"	30	S	42X2	24804423016	12,24
1" 1/4	38	S	52X2	24804523820	19,44

### Orientable Métrico

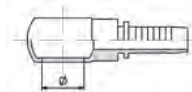

Embout Banjo droit Métrique

Banjo Metric

Raccordo ad occhio Metrico

DN	Ø	REFERENCIA PART N°	€
3/16"	M10X1	241161003	2,05
1/4"	M10X1	241161004	2,13
1/8"	M12X1	241161202	10,15
3/16"	M12X1.5	241161203	2,83
1/4"	M12X1.5	241161204	2,55
1/4"	M14X1.5	241161404	2,56
5/16"	M14X1.5	241161405	3,04
3/8"	M14X1.5	241161406	2,91
5/16"	M16X1.5	241161605	4,74
3/8"	M16X1.5	241161606	3,06
3/8"	M18X1.5	241161806	4,72
1/2"	M18X1.5	241161808	4,72
1/2"	M22X1.5	241162208	6,75
5/8"	M22X1.5	241162210	7,24
5/8"	M26X1.5	241162610	25,77
3/4"	M30X2	241163012	54,88

### Hembras giratorias 90° Métricas cono 24° con junta tórica

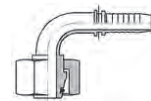

Coude 90° femelle tournante Métrique cône 24° + o'ring Série Allemande

90° Metric swivel female 24° cone with o'ring

Femmina Metrica a 90° sede 24° con o'ring

DN	TUBO PIPE	SERIE	ROSCA THREAD	REFERENCIA PART N°	€
3/16"	6	L	12X1,5	24305120603	1,97
1/4"	6	L	12X1,5	24305120604	2,20
1/4"	8	L	14X1,5	24305140804	2,47
1/4"	10	L	16X1,5	24305161004	2,68
5/16"	10	L	16X1,5	24305161005	2,33
3/8"	10	L	16X1,5	24305161006	2,56
5/16"	12	L	18X1,5	24305181205	3,04
3/8"	12	L	18X1,5	24305181206	2,86
3/8"	15	L	22X1,5	24305221506	4,72
1/2"	15	L	22X1,5	24305221508	3,84
5/8"	18	L	26X1,5	24305261810	5,80
3/4"	22	L	30X2	24305302212	7,94
1"	28	L	36X2	24305362816	16,41
1" 1/4	35	L	45X2	24305453520	26,80
1" 1/2	42	L	52X2	24305524224	43,67
1/4"	8	S	16X1,5	24305160804	2,75
1/4"	10	S	18X1,5	24305181004	2,60
5/16"	10	S	18X1,5	24305181005	7,57
5/16"	12	S	20X1,5	24305201205	3,92
3/8"	12	S	20X1,5	24305201206	2,71
3/8"	14	S	22X1,5	24305221406	4,49
1/2"	16	S	24X1,5	24305241608	4,72
5/8"	20	S	30X2	24305302010	7,87
3/4"	20	S	30X2	24305302012	11,60
3/4"	25	S	36X2	24305362512	15,04
1"	25	S	36X2	24305362516	15,75
1"	30	S	42X2	24305423016	21,51
1" 1/4	38	S	52X2	24305523820	34,53

### Tornillo orientable simple rosca Métrica

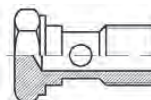

Vis creuse simple pour banjo filetage métrique

Metric bolt for Banjo

Bullone forato Metrico

ROSCA THREAD	REFERENCIA PART N°	€
M8x1	S109208	*
M10x1	S109210	*
M12x1.5	S109212	*
M14x1.5	S109214	*
M16x1.5	S109216	*
M18x1.5	S109218	*
M22x1.5	S109222	*
M26x1.5	S109226	*
M30x1.5	S109230	*

Ver precios en p.244 (ADAPTADORES BSP) // Prix à la p.244 (ADAPTEURS BSP) //  
See prices in p.244 (BSP ADAPTORS) // Vedere prezzi p.244 (ADATTATORI BSP)

## Conexiones Standard CrIII

Embouts série Standard CrIII  
Standard serie fittings CrIII  
Raccordi serie Standard CrIII

Hoses

Flexible hose fittings

Stainless steel hoses and fittings

Low pressure

Air conditioned hoses and fittings

Measuring flow

Machines for mounting flexibles

### Hembras giratorias 45° Métricas cono 24° con junta tórica

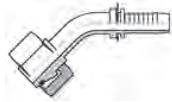

Coude 45° femelle tournante Métrique cône 24°+ o'ring Série Allemande  
45° Metric swivel female 24° cone with o'ring  
Femmina Metrica a 45° sede 24° con o'ring

DN	TUBO PIPE	SERIE	ROSCA THREAD	REFERENCIA PART N°	€
1/4"	6	L	12X1,5	24306120604	5,35
1/4"	8	L	14X1,5	24306140804	2,44
1/4"	10	L	16X1,5	24306161004	2,69
5/16"	10	L	16X1,5	24306161005	3,16
3/8"	10	L	16X1,5	24306161006	2,91
5/16"	12	L	18X1,5	24306181205	4,54
3/8"	12	L	18X1,5	24306181206	2,84
1/2"	15	L	22X1,5	24306221508	4,58
5/8"	18	L	26X1,5	24306261810	8,53
3/4"	22	L	30X2	24306302212	9,25
1"	28	L	36X2	24306362816	14,09
1" 1/4	35	L	45X2	24306453520	26,51
1" 1/2	42	L	52X2	24306524224	39,07
1/4"	8	S	16X1,5	24306160804	4,08
1/4"	10	S	18X1,5	24306181004	5,42
5/16"	12	S	20X1,5	24306201205	3,92
3/8"	12	S	20X1,5	24306201206	4,38
3/8"	14	S	22X1,5	24306221406	4,49
1/2"	16	S	24X1,5	24306241608	4,41
5/8"	20	S	30X2	24306302010	9,04
3/4"	20	S	30X2	24306302012	9,47
3/4"	25	S	36X2	24306362512	13,18
1"	25	S	36X2	24306362516	14,09
1"	30	S	42X2	24306423016	21,47
1" 1/4	38	S	52X2	24306523820	34,53

### Espigas de prensar dobles



Embout double jonction  
Double crimp standpipe  
Giunzione tubo-tubo

DN	REFERENCIA PART N°	€
1/4"	243000404	1,37
5/16"	243000505	2,14
3/8"	243000606	2,22
1/2"	243000808	2,82
3/4"	243001212	4,95
1"	243001616	9,62

### Machos Métricos cono 24°

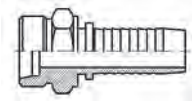

Mâle fixe Métrique cône 24°  
Metric stud 24° cone  
Maschio Metrico sede 24°

DN	TUBO PIPE	SERIE	ROSCA THREAD	REFERENCIA PART N°	€
3/16"	6	L	12X1,5	24203120603	1,18
1/4"	6	L	12X1,5	24203120604	2,12
1/4"	8	L	14X1,5	24203140804	1,35
1/4"	10	L	16X1,5	24203161004	1,82
5/16"	10	L	16X1,5	24203161005	1,48
3/8"	10	L	16X1,5	24203161006	1,60
1/4"	12	L	18X1,5	24203181204	1,57
5/16"	12	L	18X1,5	24203181205	1,81
3/8"	12	L	18X1,5	24203181206	1,55
3/8"	15	L	22X1,5	24203221506	2,36
1/2"	15	L	22X1,5	24203221508	2,02
1/2"	18	L	26X1,5	24203261808	3,46
5/8"	18	L	26X1,5	24203261810	3,06
3/4"	22	L	30X2	24203302212	6,40
1"	28	L	36X2	24203362816	9,56
1" 1/4	35	L	45X2	24203453520	13,19
1" 1/2	42	L	52X2	24203524224	21,06
1/4"	8	S	16X1,5	24203160804	1,65
1/4"	10	S	18X1,5	24203181004	2,59
5/16"	10	S	18X1,5	24203181005	1,89
3/8"	10	S	18X1,5	24203181006	3,67
5/16"	12	S	20X1,5	24203201205	2,68
3/8"	12	S	20X1,5	24203201206	2,13
3/8"	14	S	22X1,5	24203221406	2,86
1/2"	16	S	24X1,5	24203241608	2,75
5/8"	20	S	30X2	24203302010	4,96
3/4"	20	S	30X2	24203302012	8,00
3/4"	25	S	36X2	24203362512	10,66
1"	25	S	36X2	24203362516	9,75
1"	30	S	42X2	24203423016	13,74
1" 1/4	38	S	52X2	24203523820	21,83

### Machos Stecko



Mâle fixe Stecko  
Stecko male connections  
Maschio Stecko

DN	STECKO	REFERENCIA PART N°	€
1/4"	1/4"	241900404	2,24
3/8"	3/8"	241900606	3,74
1/2"	1/2"	241900808	6,82
3/4"	3/4"	241901212	7,22

## Conexiones Standard CrIII

Embouts série Standard CrIII  
Standard serie fittings CrIII  
Raccordi serie Standard CrIII

### Espiga lisa recta Métrica



Embout lisse droit Métrique  
Metric standpipe  
Estremità tubolare diritta Metrica

DN	TUBO PIPE	REFERENCIA PART N°	€
1/8"	6	241580602 L	1,18
3/16"	6	241580603 L	1,02
1/4"	6	241580604 L	1,18
3/16"	8	241580803 L	2,17
1/4"	8	241580804 L	1,31
5/16"	8	241580805 L	3,24
5/16"	10	241581005 L	1,26
3/8"	10	241581006 L	1,42
3/8"	12	241581206 L	1,28
1/2"	12	241581208 L	5,10
3/8"	15	241581506 L	1,89
1/2"	15	241581508 L	1,99
1/2"	18	241581808 L	1,73
5/8"	18	241581810 L	2,83
3/4"	22	241582212 L	6,01
1"	28	241582816 L	6,32
1"1/4	35	241583520 L	10,41
1"1/2	42	241584224 L	13,46
1/4"	10	241581004 S	1,10
1/4"	12	241581204 S	1,42
5/16"	12	241581205 S	1,42
3/8"	14	241581406 S	1,74
1/2"	14	241581408 S	2,36
1/2"	16	241581608 S	2,17
5/8"	20	241582010 S	5,24
3/4"	20	241582012 S	4,26
3/4"	25	241582512 S	5,81
1"	25	241582516 S	6,69
1"	30	241583016 S	6,41
1"1/4	38	241583820 S	14,00

### Espiga lisa a 90° Métrica

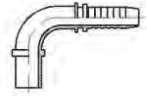

Embout lisse coude 90° Métrique  
90° Metric standpipe  
Estremità tubolare a 90° Metrica

DN	TUBO PIPE	REFERENCIA PART N°	€
1/8"	6	242580602 L	17,30
3/16"	6	242580603 L	4,80
1/4"	6	242580604 L	3,58
3/16"	8	242580803 L	7,39
1/4"	8	242580804 L	3,91
3/8"	10	242581006 L	5,22
1/4"	12	242581204 L	8,93
3/8"	12	242581206 L	4,28
1/2"	15	242581508 L	6,67
1/2"	18	242581808 L	6,65
5/8"	18	242581810 L	10,98
5/8"	22	242582210 L	13,28
3/4"	22	242582212 L	10,46
1"	28	242582816 L	26,41
1"1/4	35	242583520 L	34,90
1/4"	10	242581004 S	5,76
5/16"	12	242581205 S	5,29
3/8"	14	242581406 S	4,83
1/2"	14	242581408 S	7,03
1/2"	16	242581608 S	7,50
5/8"	20	242582010 S	14,69
3/4"	20	242582012 S	12,18
3/4"	25	242582512 S	14,97
1"	30	242583016 S	25,71

### Espiga lisa a 45° Métrica

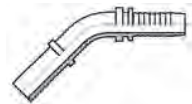

Embout lisse coude 45° Métrique  
45° Metric standpipe  
Estremità tubolare a 45° Metrica

DN	TUBO PIPE	REFERENCIA PART N°	€
3/16"	6	243580603 L	7,83
1/4"	8	243580804 L	5,76
5/16"	10	243581005 L	8,53
3/8"	10	243581006 L	7,35
3/8"	12	243581206 L	6,66
1/2"	15	243581508 L	7,96
5/8"	18	243581810 L	10,98
3/4"	22	243582212 L	17,00
1/4"	10	243581004 S	5,76
5/16"	12	243581205 S	9,39
3/8"	14	243581406 S	11,04
1/2"	16	243581608 S	9,69
3/4"	20	243582012 S	13,75
3/4"	25	243582512 S	24,31



## Conexiones Standard CrIII

Embouts série Standard CrIII  
Standard serie fittings CrIII  
Raccordi serie Standard CrIII

Hoses

Flexible hose fittings

Stainless steel hoses  
and fittings

Low pressure

Air conditioned hoses  
and fittings

Measuring flow

Machines for  
mounting flexibles

### Hembras giratorias Métricas cono 24°/60°

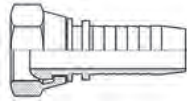

Femelle tournante Métrique cône 24°-60°  
Metric swivel female 24°/60° cone  
Femmina Metrica Multiseal 24°/60°

DN	TUBO PIPE	ROSCA THREAD	REFERENCIA PART N°	€
1/4"	8L	M14X1.5	244049511	1,51
1/4"	10L	M16X1.5	244049520	1,98
5/16"	10L	M16X1.5	244049523	1,62
3/8"	10L	M16X1.5	244049524	2,22
5/16"	12L	M18X1.5	244049525	3,09
3/8"	12L	M18X1.5	244049535	1,88
3/8"	15L	M22X1.5	244049552	3,13
1/2"	15L	M22X1.5	244049555	2,50
5/8"	18L	M26X1.5	244049571	4,40

### Hembras giratorias 90° Métricas cono 24°/60°

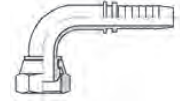

Femelle tournante coude 90° Métrique cône 24°-60°  
90° Metric swivel female 24°/60° cone  
Femmina Metrica a 90° Multiseal 24°/60°

DN	TUBO PIPE	ROSCA THREAD	REFERENCIA PART N°	€
1/4"	8L	M14X1.5	244059511	1,81
1/4"	10L	M16X1.5	244059520	2,15
5/16"	10L	M16X1.5	244059523	2,15
3/8"	10L	M16X1.5	244059524	2,41
5/16"	12L	M18X1.5	244059525	2,49
3/8"	12L	M18X1.5	244059535	2,49
3/8"	15L	M22X1.5	244059552	8,17
1/2"	15L	M22X1.5	244059555	4,21
5/8"	18L	M26X1.5	244059571	5,50

### Hembras giratorias 45° Métricas cono 24°/60°

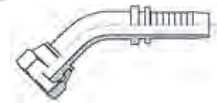

Femelle tournante coude 45° Métrique cône 24°-60°  
45° Metric swivel female 24°/60° cone  
Femmina Metrica a 45° Multiseal 24°/60°

DN	TUBO PIPE	ROSCA THREAD	REFERENCIA PART N°	€
1/4"	8L	M14X1.5	244069511	3,87
5/16"	10L	M16X1.5	244069523	4,66
3/8"	10L	M16X1.5	244069524	6,36
5/16"	12L	M18X1.5	244069525	5,97
3/8"	12L	M18X1.5	244069535	4,01
1/2"	15L	M22X1.5	244069555	7,26
5/8"	18L	M26X1.5	244069571	13,96

### Hembras giratorias rectas Komatsu cono 60°



Femelle tournante droite Komatsu Métrique (cône 60°)  
Komatsu swivel female 60° cone  
Femmina Komatsu sede 60°

DN	ROSCA THREAD	REFERENCIA PART N°	€
1/4"	M14X1.5	258049625	3,54
3/8"	M18X1.5	258049635	4,56
1/2"	M22X1.5	258049655	6,06
5/8"	M24X1.5	258049665	9,05
3/4"	M30X1.5	258049684	11,10
1"	M33X1.5	258049685	13,14

## Conexiones Standard CrIII

Embouts série Standard CrIII  
Standard serie fittings CrIII  
Raccordi serie Standard CrIII

### Macho Métrico cono 24° serie francesa

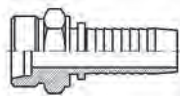

Mâle fixe gaz Série Française Métrique 24°

Metric stud 24° cone French Serie

Maschio Metrico sede 24°

DN	TUBO PIPE	ROSCA THREAD	REFERENCIA PART N°	€
1/4"	13.2	M20X1.5	245032013204	1,97
5/16"	13.2	M20X1.5	245032013205	1,69
3/8"	13.2	M20X1.5	245032013206	1,69
5/16"	16.7	M24X1.5	245032416705	2,95
3/8"	16.7	M24X1.5	245032416706	2,95
1/2"	16.7	M24X1.5	245032416708	2,95
5/8"	21.2	M30X1,5	245033021210	4,92
3/4"	21.2	M30X1,5	245033021212	4,92
3/4"	26.7	M36X1.5	245033626712	7,87
1"	33.5	M45X1.5	245034533516	12,79

### Macho Métrico válvula agrícola



Mâle fixe gaz Métrique pour valve agricole

Metric stud for agricultural valve

Maschio Metrico per valvola agricola

DN	ROSCA THREAD	REFERENCIA PART N°	€
1/4"	M18X1.5	245051804	3,09
5/16"	M18X1.5	245051805	3,09
3/8"	M18X1.5	245051806	3,43

### Hembra giratoria recta Métrica cono 24° serie francesa

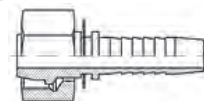

Femelle tournante gaz Série Française Métrique 24°

Metric swivel female 24° cone French Serie

Femmina Metrica sede 24°

DN	TUBO PIPE	ROSCA THREAD	REFERENCIA PART N°	€
1/4"	13.2	M20X1.5	245042013204	2,16
5/16"	13.2	M20X1.5	245042013205	2,20
3/8"	13.2	M20X1.5	245042013206	2,20
5/16"	16.7	M24X1.5	245042416705	3,46
3/8"	16.7	M24X1.5	245042416706	3,46
1/2"	16.7	M24X1.5	245042416708	3,46
5/8"	21.2	M30X1.5	245043021210	5,59
3/4"	26.7	M36X1.5	245043626712	8,89
1"	33.5	M45X1.5	245044533516	14,79

### Hembra giratoria 90° Métrica cono 24° serie francesa

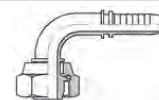

Femelle tournante gaz coude 90° Série Française Métrique 24°

90° Metric swivel female 24° cone French Serie

Femmina Metrica a 90° sede 24°

DN	TUBO PIPE	ROSCA THREAD	REFERENCIA PART N°	€
5/16"	13.2	M20X1.5	245052013205	4,41
3/8"	13.2	M20X1.5	245052013206	4,41
1/2"	16.7	M24X1.5	245052416708	5,90
5/8"	21.2	M30X1.5	245053021210	10,86
3/4"	26.7	M36X1.5	245053626712	16,76

## Conexiones Standard CrIII

Embouts série Standard CrIII  
Standard serie fittings CrIII  
Raccordi serie Standard CrIII

Hoses

### Hembra giratoria recta ORFS asiento plano



Femelle tournante série Caterpillar-ORFS fond plat  
ORFS Swivel female straight flat seat  
Femmina diritta sede piana ORFS

DN	ROSCA THREAD	REFERENCIA PART N°	€
1/4"	9/16" 18h UNF	449000404	2,06
1/4"	11/16" 16h UNF	449000604	2,49
5/16"	11/16" 16h UNF	449000605	2,49
3/8"	11/16" 16h UNF	449000606	2,58
3/8"	13/16" 16h UNF	449000806	3,01
1/2"	13/16" 16h UNF	449000808	3,01
1/2"	1" 14h UNF	449001008	5,16
5/8"	1" 14h UNF	449001010	5,16
1/2"	1" 3/16 12h UNF	449001208	7,05
3/4"	1" 3/16 12h UNF	449001212	7,05
3/4"	1" 7/16 12h UNF	449001612	9,97
1"	1" 7/16 12h UNF	449001616	10,14
1"1/4	1" 11/16 12h UNF	449002020	19,34
1"1/2	2" 12h UNF	449002424	27,94

### Hembra giratoria 90° ORFS asiento plano

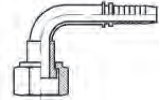

Femelle tournante coude 90° série Caterpillar-ORFS fond plat  
90° ORFS Swivel female flat seat  
Femmina a 90° sede piana ORFS

DN	ROSCA THREAD	REFERENCIA PART N°	€
1/4"	9/16" 18h UNF	449070404	2,87
5/16"	11/16" 16h UNF	449070605	3,75
3/8"	11/16" 16h UNF	449070606	3,35
3/8"	13/16" 16h UNF	449070806	5,07
1/2"	13/16" 16h UNF	449070808	6,52
1/2"	1-14h UNF	449071008	7,76
5/8"	1" 14h UNF	449071010	7,76
1/2"	1 3/16-12h UNF	449071208	10,72
3/4"	1" 3/16 12h UNF	449071212	9,59
3/4"	1" 7/16 12h UNF	449071612	16,85
1"	1" 7/16 12h UNF	449071616	16,85
1"1/4	1" 11/16 12h UNF	449072020	30,57
1"1/2	2" 12h UNF	449072424	42,79

Flexible hose fittings

Stainless steel hoses  
and fittings

### Machos ORFS asiento plano con junta tórica



Mâle fixe série Caterpillar-ORFS fond plat + o'ring  
ORFS Male flat seat + o'ring  
Maschio ORFS sede piana con o'ring

DN	ROSCA THREAD	REFERENCIA PART N°	€
1/4"	9/16" 18h UNF	449120404	6,11
1/4"	11/16" 16h UNF	449120604	11,35
5/16"	11/16" 16h UNF	449120605	11,35
3/8"	11/16" 16h UNF	449120606	6,21
1/2"	13/16" 16h UNF	449120808	6,41
5/8"	1" 14h UNF	449121010	13,32
3/4"	1" 3/16 12h UNF	449121212	14,66
1"	1" 7/16 12h UNF	449121616	24,34
1"1/4	1" 11/16-12h UNF	449122020	27,09

### Hembra giratoria 45° ORFS asiento plano

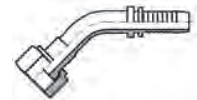

Femelle tournante coude 45° série Caterpillar-ORFS fond plat  
45° ORFS Swivel female  
Femmina a 45° sede piana ORFS

DN	ROSCA THREAD	REFERENCIA PART N°	€
1/4"	9/16" 18h UNF	449080404	3,15
3/8"	11/16" 16h UNF	449080606	3,93
3/8"	13/16" 16h UNF	449080806	5,12
1/2"	13/16" 16h UNF	449080808	5,12
1/2"	1" - 14h UNF	449081008	7,87
5/8"	1" 14h UNF	449081010	7,87
3/4"	1" 3/16 12h UNF	449081212	11,80
1"	1" 7/16 12h UNF	449081616	19,67
1"1/4	1" 11/16 12h UNF	449082020	28,53
1"1/2	2" 12h UNF	449082424	79,90

Low pressure

Air conditioned hoses  
and fittings

Measuring flow

### Juntas tóricas para ORFS



O'ringos pour ORFS  
O'ringos for ORFS  
O'ringos per raccordi ORFS

Ø in	REFERENCIA PART N°	€
9.25	9.25X1.78	0,07
7.65	7.65X1.78	0,06
12.42	12.42X1.78	0,08
15.60	15.60X1.78	0,09
18.77	18.77X1.78	0,11
23.52	23.52X1.78	0,15
29.87	29.87X1.78	0,19
37.82	37.82X1.78	0,25

Machines for  
mounting flexibles

## Conexiones Standard CrIII

Embouts série Standard CrIII  
Standard serie fittings CrIII  
Raccordi serie Standard CrIII

### Brida recta SAE 3000 PSI

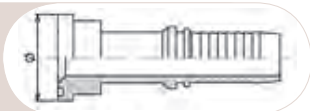

Bride SAE droite série 3000 PSI  
3000 PSI SAE Straight flange  
Flangia diritta SAE 3000 PSI

DN	Ø	REFERENCIA PART N°	€
1/2"	30.2	241820808	4,98
1/2"	38.1	241821208	7,61
5/8"	38.1	241821210	8,62
3/4"	38.1	241821212	9,33
3/4"	44.5	241821612	12,68
1"	44.5	241821616	12,78
1"	50.8	241822016	18,47
1"1/4	50.8	241822020	19,17
1"1/4	60.3	241822420	28,20
1"1/2	60.3	241822424	28,20
1"1/2	71.4	241823224	56,02
2"	71.4	241823232	50,72

### Brida recta SAE 6000 PSI

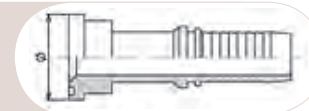

Bride SAE droite série 6000 PSI  
6000 PSI SAE Straight flange  
Flangia diritta SAE 6000 PSI

DN	Ø	REFERENCIA PART N°	€
1/2"	31.8	242820808	5,89
1/2"	41.3	242821208	8,62
5/8"	41.3	242821210	9,14
3/4"	41.3	242821212	9,95
3/4"	47.6	242821612	14,00
1"	47.6	242821616	14,41
1"	54	242822016	19,07
1"1/4	54	242822020	20,09
1"1/4	63.5	242822420	29,22
1"1/2	63.5	242822424	30,94
1"1/2	79.4	242823224	84,94
2"	79.4	242823232	57,95

### Brida a 90° SAE 3000 PSI

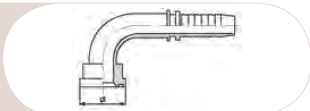

Bride SAE coude 90° série 3000 PSI  
3000 PSI SAE 90° Flange  
Flangia a 90° SAE 3000 PSI

DN	Ø	REFERENCIA PART N°	€
1/2"	30.2	241830808	6,89
1/2"	38.1	241831208	9,86
5/8"	38.1	241831210	9,86
3/4"	38.1	241831212	9,86
3/4"	44.5	241831612	17,21
1"	44.5	241831616	17,21
1"	50.8	241832016	24,18
1"1/4	50.8	241832020	24,18
1"1/4	60.3	241832420	36,26
1"1/2	60.3	241832424	36,26
1"1/2	71.4	241833224	103,73
2"	71.4	241833232	71,03

### Brida a 90° SAE 6000 PSI

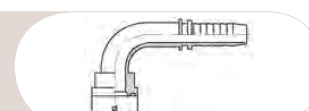

Bride SAE coude 90° série 6000 PSI  
6000 PSI SAE 90° Flange  
Flangia a 90° SAE 6000 PSI

DN	Ø	REFERENCIA PART N°	€
1/2"	31.8	242830808	7,49
1/2"	41.3	242831208	23,88
5/8"	41.3	242831210	27,18
3/4"	41.3	242831212	10,39
3/4"	47.6	242831612	17,81
1"	47.6	242831616	17,81
1"	54	242832016	25,02
1"1/4	54	242832020	25,02
1"1/4	63.5	242832420	72,55
1"1/2	63.5	242832424	37,96
1"1/2	79.4	242833224	143,26

### Brida a 45° SAE 3000 PSI

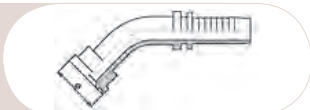

Bride SAE coude 45° série 3000 PSI  
3000 PSI SAE 45° Flange  
Flangia a 45° SAE 3000 PSI

DN	Ø	REFERENCIA PART N°	€
1/2"	30.2	241840808	6,89
1/2"	38.1	241841208	9,86
5/8"	38.1	241841210	9,86
3/4"	38.1	241841212	9,86
3/4"	44.5	241841612	17,21
1"	44.5	241841616	17,21
1"	50.8	241842016	24,18
1"1/4	50.8	241842020	24,18
1"1/4	60.3	241842420	50,75
1"1/2	60.3	241842424	36,26
1"1/2	71.4	241843224	98,72
2"	71.4	241843232	71,03

### Brida a 45° SAE 6000 PSI

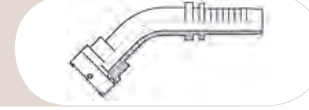

Bride SAE coude 45° série 6000 PSI  
6000 PSI SAE 45° Flange  
Flangia a 45° SAE 6000 PSI

DN	Ø	REFERENCIA PART N°	€
1/2"	31.8	242840808	7,49
1/2"	41.3	242841208	23,88
5/8"	41.3	242841210	10,39
3/4"	41.3	242841212	10,39
3/4"	47.6	242841612	17,81
1"	47.6	242841616	17,81
1"	54	242842016	25,02
1"1/4	54	242842020	25,02
1"1/4	63.5	242842420	66,76
1"1/2	63.5	242842424	37,96
1"1/2	79.4	242843224	142,74
2"	79.4	242843232	133,16

## Conexiones Standard CrIII

Embouts série Standard CrIII  
Standard serie fittings CrIII  
Raccordi serie Standard CrIII

Hoses

### Bridas SAE partidas (semibridas)

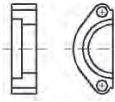

Demi-brides rectangulaires de fixation SAE  
3000/6000 PSI SAE Split flanges  
Semiflangia SAE 3000/6000 PSI

SERIE	TAMAÑO SIZE	REFERENCIA PART N°	€
3000 PSI	1/2"	<b>AFS301</b>	<b>6,00</b>
3000 PSI	3/4"	<b>AFS302</b>	<b>6,80</b>
3000 PSI	1"	<b>AFS303</b>	<b>6,33</b>
3000 PSI	1"1/4	<b>AFS304</b>	<b>8,28</b>
3000 PSI	1"1/2	<b>AFS305</b>	<b>10,92</b>
3000 PSI	2"	<b>AFS306</b>	<b>14,47</b>
3000 PSI	2"1/2	<b>AFS307</b>	<b>29,37</b>
3000 PSI	3"	<b>AFS308</b>	<b>47,91</b>
3000 PSI	3"1/2	<b>AFS309</b>	<b>74,41</b>
3000 PSI	4"	<b>AFS310</b>	<b>93,95</b>
3000 PSI	5"	<b>AFS311</b>	<b>117,93</b>
6000 PSI	1/2"	<b>AFS601</b>	<b>5,04</b>
6000 PSI	3/4"	<b>AFS602</b>	<b>7,79</b>
6000 PSI	1"	<b>AFS603</b>	<b>11,90</b>
6000 PSI	1"1/4	<b>AFS604</b>	<b>18,64</b>
6000 PSI	1"1/2	<b>AFS605</b>	<b>29,64</b>
6000 PSI	2"	<b>AFS606</b>	<b>44,11</b>

### Bridas SAE enteras (monoblock)

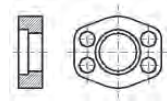

Brides monobloc rectangulaires de fixation SAE  
3000/6000 PSI SAE Flanges  
Flangia SAE 3000/6000 PSI

SERIE	TAMAÑO SIZE	REFERENCIA PART N°	€
3000 PSI	1/2"	<b>AFSI301</b>	<b>4,40</b>
3000 PSI	3/4"	<b>AFSI302</b>	<b>5,76</b>
3000 PSI	1"	<b>AFSI303</b>	<b>6,56</b>
3000 PSI	1"1/4	<b>AFSI304</b>	<b>8,24</b>
3000 PSI	1"1/2	<b>AFSI305</b>	<b>11,12</b>
3000 PSI	2"	<b>AFSI306</b>	<b>14,56</b>
3000 PSI	2"1/2	<b>AFSI307</b>	<b>27,60</b>
3000 PSI	3"	<b>AFSI308</b>	<b>43,81</b>
3000 PSI	3"1/2	<b>AFSI309</b>	<b>74,41</b>
3000 PSI	4"	<b>AFSI310</b>	<b>93,95</b>
3000 PSI	5"	<b>AFSI311</b>	<b>117,93</b>
6000 PSI	1/2"	<b>AFSI601</b>	<b>4,88</b>
6000 PSI	3/4"	<b>AFSI602</b>	<b>7,92</b>
6000 PSI	1"	<b>AFSI603</b>	<b>12,08</b>
6000 PSI	1"1/4	<b>AFSI604</b>	<b>16,08</b>
6000 PSI	1"1/2	<b>AFSI605</b>	<b>26,56</b>
6000 PSI	2"	<b>AFSI606</b>	<b>41,77</b>

Flexible hose fittings

Stainless steel hoses  
and fittings

Low pressure

### Junta tórica para brida SAE



O'rings pour bride série 3000/6000 PSI  
O'rings for 3000/6000 PSI SAE flanges  
O'rings per flangia SAE

Ø in	REFERENCIA PART N°	€
18.64	<b>18.64X3.53</b>	<b>0,17</b>
24.99	<b>24.99X3.53</b>	<b>0,22</b>
47.22	<b>47.22X3.53</b>	<b>0,45</b>
56.74	<b>56.74X3.53</b>	<b>0,55</b>
32.92	<b>32.92X3.53</b>	<b>0,29</b>

### Juntas para bridas



Jointes pour bride série 3000/6000  
Seals for 3000/6000 PSI flange  
Guarnizioni per flangia SAE 3000/6000 PSI

Ø ext	Ø in	REFERENCIA PART N°	€
25.40	17.02	<b>JBR08</b>	<b>2,87</b>
31.72	23.36	<b>JBR12</b>	<b>2,97</b>
39.62	31.24	<b>JBR16</b>	<b>3,10</b>
44.45	36.07	<b>JBR20</b>	<b>3,65</b>
53.98	45.34	<b>JBR24</b>	<b>3,85</b>
63.50	54.86	<b>JBR32</b>	<b>4,03</b>

Air conditioned hoses  
and fittings

Measuring flow

Machines for  
mounting flexibles

## Conexiones Standard CrIII

Embouts série Standard CrIII  
Standard serie fittings CrIII  
Raccordi serie Standard CrIII

### Brida recta Caterpillar 9000 PSI

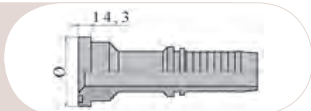

Bride tournante droite Caterpillar série 9000 PSI  
9000 PSI Caterpillar straight Flange  
Flangia diritta Caterpillar

DN	Ø	REFERENCIA PART N°	€
3/4"	41.3	G442821212	*
3/4"	47.6	G442821612	*
1"	47.6	G442821616	*
1"	54	G442822016	*
1"1/4	54	G442822020	*
1"1/2	63.5	G442822424	*

Ver p.72 (Conexiones Standard Zn/Ni) // Voir p.72 (Embouts Série Standard Zn/Ni) // See p.72 (Standard Serie Fittings Zn/Ni) // Vedere p.72 (Raccordi Serie Standard Zn/Ni)

### Brida a 90° Caterpillar 9000 PSI

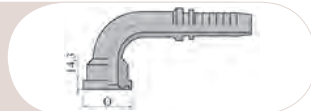

Bride tournante coude 90° Caterpillar série 9000 PSI  
9000 PSI Caterpillar 90° Flange  
Flangia a 90° Caterpillar

DN	Ø	REFERENCIA PART N°	€
3/4"	41.3	G442831212	*
3/4"	47.6	G442831612	*
1"	47.6	G442831616	*
1"	54	G442832016	*
1"1/4	54	G442832020	*
1"1/2	63.5	G442832424	*

Ver p.72 (Conexiones Standard Zn/Ni) // Voir p.72 (Embouts Série Standard Zn/Ni) // See p.72 (Standard Serie Fittings Zn/Ni) // Vedere p.72 (Raccordi Serie Standard Zn/Ni)

### Brida a 45° Caterpillar 9000 PSI

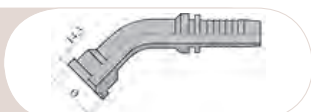

Bride tournante coude 45° Caterpillar série 9000 PSI  
9000 PSI Caterpillar 45° Flange  
Flangia a 45° Caterpillar

DN	Ø	REFERENCIA PART N°	€
3/4"	41.3	G442841212	*
3/4"	47.6	G442841612	*
1"	47.6	G442841616	*
1"	54	G442842016	*
1"1/4	54	G442842020	*
1"1/2	63.5	G442842424	*

Ver p.72 (Conexiones Standard Zn/Ni) // Voir p.72 (Embouts Série Standard Zn/Ni) // See p.72 (Standard Serie Fittings Zn/Ni) // Vedere p.72 (Raccordi Serie Standard Zn/Ni)

## Conexiones Standard CrIII

Embouts série Standard CrIII  
Standard serie fittings CrIII  
Raccordi serie Standard CrIII

Hoses

Flexible hose fittings

Stainless steel hoses  
and fittings

Low pressure

Air conditioned hoses  
and fittings

Measuring flow

Machines for  
mounting flexibles

### Espiga para brida macho Poclairn

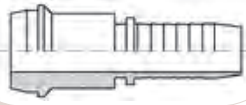

Embout bride mâle Poclairn  
Poclairn male flange

Inserto per flangia maschio Poclairn

DN	Ø	REFERENCIA PART N°	€
1/2"	1/2"	448010808	9,31
5/8"	5/8"	448011010	11,09
3/4"	3/4"	448011212 *	14,81
1"	1"	448011616 *	18,19
1"1/4	1"1/4	448012020 *	23,78

Hasta fin existencias. \*Ver alternativa p.58 (Conexiones Interlock)/Jusqu'à la fin du stock. \*Voir alternative p.58 (Interlock)/Until end of stock. \*See alternative p.58 (Interlock Fittings)/Fino ad esaurimento scorta. \*Vedere alternativa p.58 (Interlock)

### Espiga a 90° brida macho Poclairn

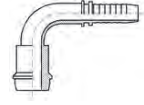

Embout bride coude 90° macho Poclairn  
90° Poclairn female flange standpipe  
Inserto per flangia a 90° Poclairn

DN	Ø	REFERENCIA PART N°	€
1/2"	1/2"	448030808	17,11
1"1/4	1"1/4	448032020 *	47,24

Hasta fin existencias. \*Ver alternativa p.58 (Conexiones Interlock)/Jusqu'à la fin du stock. \*Voir alternative p.58 (Interlock)/Until end of stock. \*See alternative p.58 (Interlock Fittings)/Fino ad esaurimento scorta. \*Vedere alternativa p.58 (Interlock)

### Espiga para brida hembra Poclairn

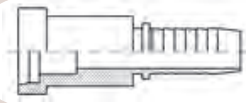

Embout bride femelle Poclairn  
Poclairn female flange  
Inserto per flangia femmina Poclairn

DN	Ø	REFERENCIA PART N°	€
5/8"	5/8"	448021010	11,09
3/4"	3/4"	448021212 *	14,81
1"1/4	1"1/4	448022020 *	23,78

Hasta fin existencias. \*Ver alternativa p.58 (Conexiones Interlock)/Jusqu'à la fin du stock. \*Voir alternative p.58 (Interlock)/Until end of stock. \*See alternative p.58 (Interlock Fittings)/Fino ad esaurimento scorta. \*Vedere alternativa p.58 (Interlock)

### Brida entera macho Poclairn 4 agujeros

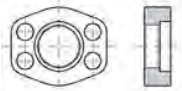

Bride rectangulaire de fixation mâle Poclairn-4 trous  
Male Poclairn flange 4 holes  
Flangia intera maschio Poclairn 4 fori

TUBO PIPE	REFERENCIA PART N°	€
1/2"	448050808 *	12,80
5/8"	448051010 *	13,30
3/4"	448051212	23,08
1"	448051616	27,52
1" 1/4	448052020	36,55

\*Hasta fin de existencias. / Jusqu'à la fin du stock. / Until end of stock. / Fino ad esaurimento scorta.

### Brida entera hembra Poclairn 4 agujeros



Bride rectangulaire de fixation femelle Poclairn 4 trous  
Female Poclairn flange 4 holes  
Flangia intera femmina Poclairn 4 fori

TUBO PIPE	REFERENCIA PART N°	€
1/2"	448060808 *	12,80
3/4"	448061212	32,08
1"	448061616	36,50
1" 1/4	448062020	45,54

\*Hasta fin de existencias. / Jusqu'à la fin du stock. / Until end of stock. / Fino ad esaurimento scorta.

### Brida entera macho Poclairn 2 agujeros

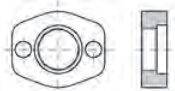

Bride ovale fixation mâle Poclairn 2 trous  
Male Poclairn flange 2 holes  
Flangia intera maschio Poclairn 2 fori

TUBO PIPE	REFERENCIA PART N°	€
1/2"	448070808	18,50
5/8"	448071010	19,21
3/4"	448071212	22,65
1"	448071616	24,80
1"1/4	448072020	39,50

### Brida entera hembra Poclairn 2 agujeros

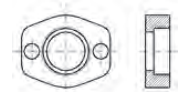

Bride ovale fixation femelle Poclairn 2 trous  
Female Poclairn flange 2 holes  
Flangia intera femmina Poclairn 2 fori

TUBO PIPE	REFERENCIA PART N°	€
5/8"	448081010	19,50
3/4"	448081212	26,15
1"	448081616	19,35
1"1/4	448082020	21,05

## Conexiones Standard CrIII

Embouts série Standard CrIII  
Standard serie fittings CrIII  
Raccordi serie Standard CrIII

55

### Macho pistola hidrolavadora

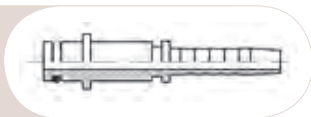

Mâle fixe spécial pistolet-hydroneurotoyage  
Male terminal steel hydro-wash  
Maschio pistola idropulitrice

DN	REFERENCIA PART N°	€
1/4"	230400400	1,55

### Empuñaduras de goma negras



Poignée hydroneurotoyage de gomme noire  
Handle with black rubber  
Manopola di gomma nera

DN	REFERENCIA PART N°	€
1/4"	230600400	1,30
5/16"	230600500	1,66
3/8"	230600600	1,51

### Empuñaduras de goma grises



Poignée hydroneurotoyage de gomme grise  
Handle with grey rubber  
Manopola di gomma grigia

DN	REFERENCIA PART N°	€
1/4"	230610400	1,97
5/16"	230610500	2,54
3/8"	230610600	2,23

### Terminal Karcher acero

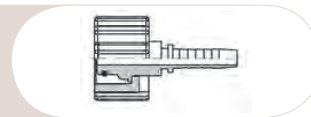

Embout femelle tournante acier spécial hydroneurotoyage  
Swivel female steel hydro-wash  
Femmina in acciaio per idropulitrici

TUBO PIPE	ROSCA THREAD	Descripción Description	REFERENCIA PART N°	€
1/4"	M22X1.5	STD	230700400	4,24
5/16"	M22X1.5	STD	230700500	4,29
3/8"	M22X1.5	STD	230700600	4,79
5/16"	M22X1.5	Larga/Long	230720500	4,72
3/8"	M22X1.5	Larga/Long	230720600	5,03

### Empuñaduras de goma azules



Poignée hydroneurotoyage de gomme bleue  
Handle with blue rubber  
Manopola di gomma azzurra

DN	REFERENCIA PART N°	€
1/4"	230620400	2,02
5/16"	230620500	2,54
3/8"	230620600	2,23

Hoses

Flexible hose fittings

Stainless steel hoses  
and fittings

Low pressure

Air conditioned hoses  
and fittings

Measuring flow

Machines for  
mounting flexibles



## Conexiones Interlock CrIII

Embouts à sertir Interlock CrIII  
Interlock serie fittings CrIII  
Raccordi serie Interlock CrIII

### Casquillos 4SH



Juqe à sertir DIN 20023 4SH  
Ferrules DIN 20023-4SH  
Boccola Interlock 4SH

DN	REFERENCIA PART N°	€
3/4"	BA610101200	6,30
1"	BA610101600	10,51
1"1/4	BA610102000	18,14

### Hembras giratorias rectas BSP cono 60°



Femelle fournante gaz cyl BSP 60° + o'ring  
BSP swivel female 60° cone  
Femmina diritta BSP sede 60° con o'ring

DN	ROSCA THREAD	REFERENCIA PART N°	€
3/4"	3/4" BSP	B641001212	5,37
1"	1" BSP	B641001616	12,26
1"1/4	1"1/4 BSP	B641002020	16,55

### Macho rosca cilindrica BSP cono 60°

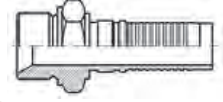

Mâle fixe gaz cyl BSP 60°  
BSP Male 60° cone  
Maschio cilindrico BSP sede 60°

DN	ROSCA THREAD	REFERENCIA PART N°	€
3/4"	3/4" BSP	B641121212	7,36
1"	1" BSP	B641121616	12,95
1"1/4	1"1/4 BSP	B641122020	18,78

### Hembras giratorias 90° BSP cono 60°

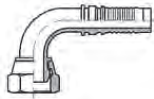

Femelle tournante coude 90° gaz cyl BSP 60° + o'ring  
90° BSP swivel female 60° cone  
Femmina a 90° BSP sede 60° con o'ring

DN	ROSCA THREAD	REFERENCIA PART N°	€
3/4"	3/4" BSP	B641071212	10,65
1"	1" BSP	B641071616	20,69
1"1/4	1"1/4 BSP	B641072020	30,58

### Hembras giratorias rectas JIC 37°



Femelle tournante JIC 37°  
JIC 37° swivel female  
Femmina diritta JIC 37°

DN	ROSCA THREAD	REFERENCIA PART N°	€
3/4"	1"1/16 12h UNF	B641421712	4,60
1"	1"5/16 12h UNF	B641422116	9,20
1"1/4	1"5/8 12h UNF	B641422620	15,25

### Hembras giratorias 90° JIC 37°

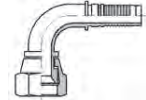

Femelle tournante coude 90° JIC 37°  
90° JIC 37° swivel female  
Femmina a 90° JIC 37°

DN	ROSCA THREAD	REFERENCIA PART N°	€
3/4"	1"1/16 12h UNF	B641381712	*
1"	1"5/16 12h UNF	B641382116	*
1"1/4	1"5/8 12h UNF	B641382620	*
1"1/2	1"7/8 12h UNF	B641383024	*
2"	2"1/2 12h UNF	B641384032	*

## Conexiones Interlock CrIII

Embouts à sertir Interlock CrIII  
Interlock serie fittings CrIII  
Raccordi serie Interlock CrIII

57

Hoses

Flexible hose fittings

Stainless steel hoses and fittings

Low pressure

Air conditioned hoses and fittings

Measuring flow

Machines for mounting flexibles

### Hembra giratoria recta métrica cono 24° con junta tórica

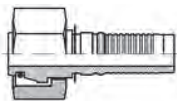

Femelle tournante métrique 24° + o´ring  
Metric swivel female 24° seat with o´ring  
Femmina metrica sede 24° con o´ring

DN	TUBO PIPE	SERIE	ROSCA THREAD	REFERENCIA PART N°	€
3/4"	20	S	M30X2	B64204302012	8,81
3/4"	25	S	M36X2	B64204362512	9,20
1"	30	S	M42X2	B64204423016	14,56
1"1/4	38	S	M52X2	B64204523820	23,76

### Hembra giratoria 90° métrica cono 24° con junta tórica

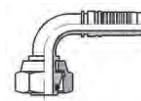

Femelle tournante coude 90° métrique 24° + o´ring  
90° Metric swivel female 24° seat with o´ring  
Femmina a 90° Metrica sede 24° con o´ring

DN	TUBO PIPE	SERIE	ROSCA THREAD	REFERENCIA PART N°	€
3/4"	20	S	M30X2	B64205302012	*
3/4"	25	S	M36X2	B64205362512	*
1"	30	S	M42X2	B64205423016	*
1"1/4	38	S	M52X2	B64205523820	*

### Racores para martillo

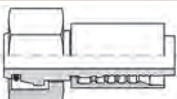

Embouts pour marteau  
Fittings for hammer  
Raccordi per martello

DN	TUBO PIPE	SERIE	ROSCA THREAD	REFERENCIA PART N°	€
3/4"	25	S	M36X2	NAM362512	43,73
1"	30	S	M42X2	NAM423016	52,42
1 1/4"	38	S	M52X2	NAM523820	81,46

Se venden con casquillo incluido // Avec jupe incluse // With ferrule included // Con boccola inclusa

### Brida SAE 3000 PSI

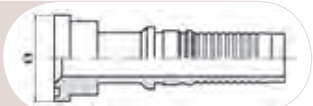

Bride SAE droite série 3000 PSI  
3000 PSI SAE straight flange  
Flangia SAE 3000 PSI

DN	Ø	REFERENCIA PART N°	€
3/4"	38.1	B641821212	9,27
1"	44.5	B641821616	14,64
1"1/4	50.8	B641822020	22,22

### Brida 90° SAE 3000 PSI

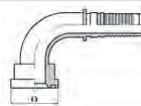

Bride SAE coude 90° série 3000 PSI  
90° 3000 PSI SAE flange  
Flangia a 90° SAE 3000 PSI

DN	Ø	REFERENCIA PART N°	€
3/4"	38.1	B641831212	15,56
1"	44.5	B641831616	19,93
1"1/4	50.8	B641832020	27,59

### Brida SAE 6000 PSI

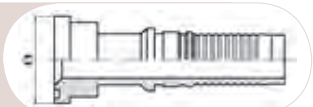

Bride SAE droite série 6000 PSI  
6000 PSI SAE straight flange  
Flangia SAE 6000 PSI

DN	Ø	REFERENCIA PART N°	€
3/4"	41.3	B642821212	10,35
1"	47.6	B642821616	15,63
1"1/4	54	B642822020	24,14

### Brida 90° SAE 6000 PSI

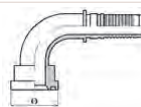

Bride SAE coude 90° serie 6000 PSI  
90° 6000 PSI SAE flange  
Flangia 90° SAE 6000 PSI

DN	Ø	REFERENCIA PART N°	€
3/4"	41.3	B642831212	13,79
1"	47.6	B642831616	21,46
1"1/4	54	B642832020	31,73

## Conexiones Interlock CrIII

Embouts à sertir Interlock CrIII  
Interlock serie fittings CrIII  
Raccordi serie Interlock CrIII

Hoses

### Espiga para brida macho Poclairn



Embout bride mâle Poclairn

Poclairn male flange

Inserto per flangia maschio Poclairn 4SH

DN	Ø	REFERENCIA PART N°	€
3/4"	3/4"	648011212	19,70
1"	1"	648011616	24,01
1"1/4	1"1/4	648012020	35,02

### Brida entera hembra Poclairn 4 agujeros

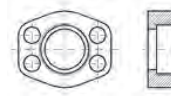

Bride rectangulaire de fixation femelle Poclairn-4 trous

Female Poclairn flange 4 holes

Flangia intera femmina Poclairn 4 fori

TUBO PIPE	REFERENCIA PART N°	€
1/2"	448060808 *	12,80
3/4"	448061212	32,08
1"	448061616	36,50
1" 1/4	448062020	45,54

Flexible hose fittings

Stainless steel hoses  
and fittings

### Brida entera macho Poclairn 4 agujeros

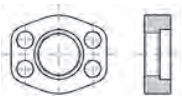

Bride rectangulaire de fixation mâle Poclairn-4 trous

Male Poclairn flange 4 holes

Flangia intera maschio Poclairn 4 fori

TUBO PIPE	REFERENCIA PART N°	€
1/2"	448050808 *	12,80
5/8"	448051010 *	13,30
3/4"	448051212	23,08
1"	448051616	27,52
1" 1/4	448052020	36,55

### Brida entera macho Poclairn 2 agujeros

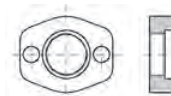

Bride ovale fixation mâle Poclairn 2 trous

Male Poclairn flange 2 holes

Flangia intera maschio Poclairn 2 fori

TUBO PIPE	REFERENCIA PART N°	€
1/2"	448070808	18,50
5/8"	448071010	19,21
3/4"	448071212	22,65
1"	448071616	24,80
1"1/4	448072020	39,50

Low pressure

Air conditioned hoses  
and fittings

Measuring flow

### Espiga para brida hembra Poclairn



Embout bride femelle Poclairn

Poclairn female flange

Inserto per flangia femmina Poclairn 4SH

DN	Ø	REFERENCIA PART N°	€
3/4"	3/4"	648021212	19,70
1"	1"	648021616	24,01
1"1/4	1"1/4	648022020	35,02

### Brida entera hembra Poclairn 2 agujeros



Bride ovale fixation femelle Poclairn 2 trous

Female Poclairn flange 2 holes

Flangia intera femmina Poclairn 2 fori

TUBO PIPE	REFERENCIA PART N°	€
5/8"	448081010	19,50
3/4"	448081212	26,15
1"	448081616	19,35
1"1/4	448082020	21,05

Machines for  
mounting flexibles

## Conexiones Reusables CrIII

Embouts Récuperables CrIII

Reusable serie fittings CrIII

Raccordi serie Recuperabile CrIII

### Casquillos R1A

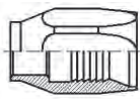

Jupes à visser R1A

Ferrules R1A

Boccola R1A

DN	REFERENCIA PART N°	€
1/4"	A1G-4 R1	3,04
3/8"	A1G-6 R1	3,88
1/2"	A1G-8 R1	4,83
5/8"	A1G-10 R1	9,30
3/4"	A1G-12 R1	9,83

### Casquillos R2A

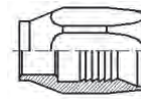

Jupes à visser R2A

Ferrules R2A

Boccola R2A

DN	REFERENCIA PART N°	€
1/4"	A1G-4 R2	3,04
5/16"	A1G-5 R2	3,13
3/8"	A1G-6 R2	3,86
1/2"	A1G-8 R2	5,07
5/8"	A1G-10 R2	9,30
3/4"	A1G-12 R2	9,83
1"	A1G-16 R2	24,53

### Casquillos R1AT

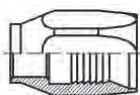

Jupes à visser R1AT

Ferrules R1AT

Boccola R1AT

DN	REFERENCIA PART N°	€
1/4"	A1G-4 R1T	4,34
3/8"	A1G-6 R1T	6,75
1/2"	A1G-8 R1T	6,63

### Casquillos R2AT

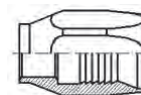

Jupes à visser R2AT

Ferrules R2AT

Boccola R2AT

DN	REFERENCIA PART N°	€
1/4	A1G-4 R2T	4,01
3/8"	A1G-6 R2T	5,36
1/2"	A1G-8 R2T	6,04

### Hembras giratorias rectas BSP cono 60°



Femelle tournante gaz cyl BSP 60°

BSP Swivel female 60° cone

Femmina diritta recuperabile BSP sede 60°

DN	ROSCA THREAD	REFERENCIA PART N°	€
1/4"	1/4" BSP	A3G-4	3,63
1/4"	3/8" BSP	A3G-6-4	6,34
5/16"	3/8" BSP	A3G-6-5	6,34
3/8"	3/8" BSP	A3G-6	4,71
3/8"	1/2" BSP	A3G-8-6	9,17
1/2"	1/2" BSP	A3G-8	6,45
5/8"	5/8" BSP	A3G-10	14,05
1/2"	3/4" BSP	A3G-12-8	14,17
3/4"	3/4" BSP	A3G-12	13,81
5/8"	3/4" BSP	A3G 12-10	20,83
1"	1" BSP	A3G-16	23,67

### Hembras giratorias 90° BSP cono 60°

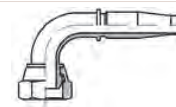

Femelle tournante coude 90° gaz cyl BSP 60°

BSP 90° Swept elbow 60° cone

Femmina a 90° recuperabile BSP sede 60°

DN	ROSCA THREAD	REFERENCIA PART N°	€
1/4"	1/4" BSP	A90G-4	6,34
5/16"	3/8" BSP	A90G-6-5	7,07
3/8"	3/8" BSP	A90G-6	7,08
3/8"	1/2" BSP	A90G-8-6	9,01
1/2"	1/2" BSP	A90G-8	9,44
1/2"	3/4" BSP	A90G-12-8	13,05
3/4"	3/4" BSP	A90G-12	16,14
3/4"	1" BSP	A90G-16-12	22,40
1"	1" BSP	A90G-16	29,63

## Conexiones Reusables CrIII

Embouts Récuperables CrIII

Reusable serie fittings CrIII

Raccordi serie Recuperabile CrIII

### Machos rosca cilíndrica BSP cono 60°

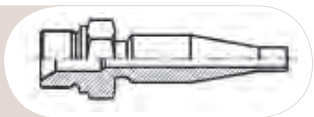

Mâle gaz cyl BSP 60°  
BSP Male parallel 60° cone  
Maschio cilindrico recuperabile BSP sede 60°

DN	ROSCA THREAD	REFERENCIA PART N°	€
1/4"	1/4" BSP	A2G-4	2,64
1/4"	3/8" BSP	A2G-6-4	4,37
5/16"	3/8" BSP	A2G-6-5	4,37
3/8"	3/8" BSP	A2G-6	3,71
3/8"	1/2" BSP	A2G-8-6	6,07
1/2"	1/2" BSP	A2G-8	5,17
5/8"	5/8" BSP	A2G-10	9,10
1/2"	3/4" BSP	A2G-12-8	9,98
3/4"	3/4" BSP	A2G-12	9,98
5/8"	3/4" BSP	A2G-12-10	9,99
3/4"	1" BSP	A2G-16-12	17,51
1"	1" BSP	A2G-16	17,52

### Espigas lisas Métricas



Embout lisse Métrique  
Metric Standpipe  
Estremitá tubolare Metrica recuperabile

DN	TUBO PIPE	REFERENCIA PART N°	€
1/4"	6	AE 6-4	8,84
1/4"	8	AE 8-4	8,84
1/4"	10	AE 10-4	10,04
5/16"	10	AE 10-5	10,04
3/8"	10	AE 10-6	13,25
5/16"	12	AE 12-5	13,25
3/8"	12	AE 12-6	13,25
1/2"	15	AE 15-8	15,34
1/2"	16	AE 16-8	15,34
5/8"	18	AE 18-10	18,22
5/8"	20	AE 20-10	18,22
3/4"	22	AE 22-12	21,79
3/4"	25	AE 25-12	21,79

### Machos Stecko

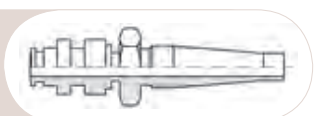

Mâle Stecko  
Male Stecko connections  
Maschio Stecko recuperabile

DN	STECKO	REFERENCIA PART N°	€
1/4"	1/4"	S2G-4	3,62
1/4"	3/8"	S2G-6-4	6,19
1/2"	1/2"	S2G-8	3,00

Hasta fin de existencias // Jusqu'à la fin du stock // Until end of stock // Fino ad esaurimento scorta

### Orientables BSP



Banjo droit tube gaz cyl BSP  
Banjo BSP  
Raccordo ad occhio BSP recuperabile

DN	Ø	REFERENCIA PART N°	€
1/4"	1/4" BSP	AOG-4	6,84
5/16"	3/8" BSP	AOG-6-5	8,92
3/8"	3/8" BSP	AOG-6	8,91
3/8"	1/2" BSP	AOG-8-6	12,64
1/2"	1/2" BSP	AOG-8	12,64
1/2"	3/4" BSP	AOG-12-8	26,94
3/4"	3/4" BSP	AOG-12	24,93
3/4"	1" BSP	AOG-16-12	46,67
1"	1" BSP	AOG-16	54,81

## Conexiones alta presión (700 Bar) CrIII

Embouts haute pression 700 Bar CrIII  
High pressure 700 Bar fittings CrIII  
Raccordi Altissima pressione (700 Bar) CrIII

### Manguera termoplástica 700 bar



Tuyau thermoplastique haute pression 700 bar  
Thermoplastic hose 700 bar  
Tubo termoplastico 700 bar

DN	Ø in	REFERENCIA PART N°	€
1/4"	6	MT70004	21,62
3/8"	10	MT70006	42,48

### Casquillos manguera 700 bar tipo M352

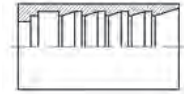

Jupes à sertir thermoplastique 700 bar type M352  
Ferrules for thermoplastic hose 700 bar  
Boccole per tubo termoplastico 700 bar tipo M352

DN	REFERENCIA PART N°	€
1/4"	710120400	1,45
3/8"	710120600	2,44

### Hembra giratoria recta BSP 60°

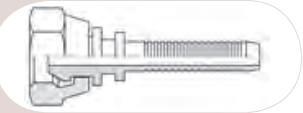

Embout thermoplastique 700 bar femelle tournante gaz cyl BSP 60°  
BSP Swivel female 60° cone  
Femmina diritta BSP sede 60°

DN	ROSCA THREAD	REFERENCIA PART N°	€
1/4"	1/4" BSP	741000404	5,04

### Macho NPT

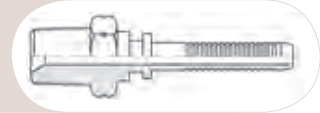

Embout thermoplastique 700 bar mâle fixe gaz conique NPT  
NPT Male thread  
Maschio conico NPT

DN	ROSCA THREAD	REFERENCIA PART N°	€
1/4"	1/4" NPT	741610404	2,51
1/4"	3/8" NPT	741610604	3,84
3/8"	3/8" NPT	741610606	2,97

### Macho BSP 60°



Embout thermoplastique 700 bar mâle fixe gaz cyl BSP 60°  
BSP Male parallel 60° cone  
Maschio cilindrico BSP sede 60°

DN	ROSCA THREAD	REFERENCIA PART N°	€
1/4"	1/4" BSP	741120404	3,76
3/8"	3/8" BSP	741120606	3,66

### Hembra giratoria recta JIC 37°

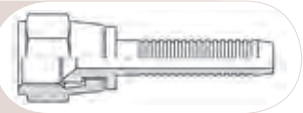

Femelle tournante droite JIC 74°  
JIC Swivel female 37° cone  
Femmina JIC 37°

DN	ROSCA THREAD	REFERENCIA PART N°	€
1/4"	9/16" UNF	741420904	24,29

## Nuevo tratamiento superficial: zincado ecológico Zn/Ni

New surface treatment: ecological Zn/Ni coating

Nouveau traitement de surface: passivation écologique Zn/Ni

Nuovo trattamento superficiale: zincatura ecologica Zn/Ni

- Solución ecológica sin Cromo
- Color gris mate
- Super resistente a la corrosión
- No se alteran las propiedades mecánicas de las piezas

- Ecological Chromium-free solution
- Matt grey color
- Extra resistance to corrosion
- Tightening torque value unchanged

- Solution écologique sans Chrome
- Couleur gris mat
- Très résistant à la corrosion
- Les propriétés mécaniques des pièces ne sont pas modifiées

- Soluzione ecologica senza Cromo
- Colore grigio opaco
- Super resistenza alla corrosione
- Non viene alterata la proprietà
- meccanica degli articoli

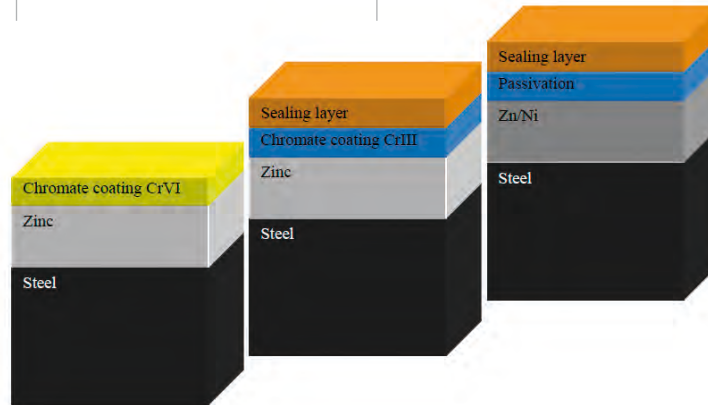

Ensayos en niebla salina

- artículos no prensados: Zn/Ni: > 700 horas
- artículos prensados: Zn/Ni: > 350 horas

Salt spray results

- non swaged parts: Zn/Ni: > 700 hours
- swaged parts: Zn/Ni: > 350 hours

Essais brouillard salin

- articles non sertis: Zn/Ni: > 700 heures
- articles sertis: Zn/Ni: > 350 heures

Prova in nebbia salina

- articoli non pressati: Zn/Ni: > 700 ore
- articoli pressati: Zn/Ni: > 350 ore



Este nuevo tratamiento solo está disponible en Racores para tubería flexible y Racores DIN 2353.

This new treatment is only available for flexible hose fittings and DIN 2353 pipe fittings.

Ce nouveau traitement est disponible uniquement pour les embouts de flexibles et les raccords DIN 2353.

Questo nuovo trattamento è disponibile solo nei raccordi per tubo flessibile e Raccordi DIN 2353.

## Conexiones Standard Zn/Ni

Embouts série Standard Zn/Ni  
Standard serie fittings Zn/Ni  
Raccordi serie Standard Zn/Ni

### Casquillos R1A

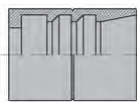

Jupes à sertir pour R1A

Ferrules R1A

Boccole a pressare per R1A

DN	REFERENCIA PART N°	€
3/16"	220030300	1,42
1/4"	220030400	1,20
5/16"	220030500	1,19
3/8"	220030600	1,35
1/2"	220030800	1,85
5/8"	220031000	2,48
3/4"	220031200	3,27
1"	220031600	5,42
1"1/4	220032000	11,06
1"1/2	220032400	13,69
2"	220033200	27,97

### Casquillos R1AT/ R2AT/1SN/2SN/2SC

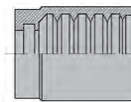

Jupes à sertir R1AT/R2AT/1SN/2SN/2SC

Ferrules R1AT/R2AT/2SC1SN/2SN

Boccole a pressare per R1AT/R2AT/1SN/2SN/2SC

DN	REFERENCIA PART N°	€
3/16"	PF221200300	1,27
1/4"	PF221200400	1,14
5/16"	PF221200500	1,20
3/8"	PF221200600	1,35
1/2"	PF221200800	1,62
5/8"	PF221201000	2,39
3/4"	PF221201200	3,40
1"	PF221201600	5,93
1"1/4	PF221202000	13,88
1"1/2	PF221202400	17,59
2"	PF221203200	33,72

### Casquillos R2A-2ST / DIN 20023 4SP

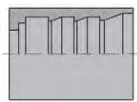

Jupes à sertir R2A-2ST / DIN 20023 4SP

Ferrules R2A-2ST / DIN 20023 4SP

Boccole a pressare per R2A-2ST / DIN 20023 4 SP

DN	REFERENCIA PART N°	€
3/16"	PF122400300	1,61
1/4"	PF122400400	1,10
5/16"	PF122400500	1,29
3/8"	PF122400600	1,49
1/2"	PF122400800	1,88
5/8"	PF122401000	2,61
3/4"	PF122401200	3,71
1"	PF122401600	6,28
1"1/4	PF122402000	12,92
1"1/2	PF122402400	17,59
2"	PF122403200	35,01

### Casquillos R7, R8 y malla metálica

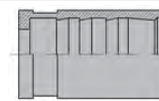

Jupes à sertir R7, R8 et tresse métallique

Ferrules SAE 100 R7, R8 and metallic braid

Boccole a pressare per SAE R7, R8 e Treccia Metallica

DN	REFERENCIA PART N°	€
3/16"	PF2300300	0,94
1/4"	PF2300400	1,00
5/16"	PF2300500	1,20
3/8"	PF2300600	1,23
1/2"	PF2300800	1,65

### Casquillos Teflón Liso alta presión

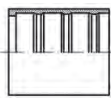

Jupes à sertir pour Teflon Lisse haute pression

Ferrules for Smooth PTFE

Boccole a pressare per tubo al Teflon Liscio alta pressione

DN	REFERENCIA PART N°	€
3/16"	210400300	*
1/4"	210400400	*
5/16"	210400500	*
3/8"	210400600	*
1/2"	210400800	*
5/8"	210401000	*
3/4"	210401200	*
1"	210401600	*

### Casquillos Teflón Corrugado alta presión

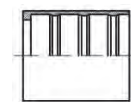

Jupes à sertir Teflon Convoluté haute pression

Ferrules for Convoluted PTFE

Boccole a pressare per tubo al Teflon Corrugato alta pressione

DN	REFERENCIA PART N°	€
1/4"	210410400	*
3/8"	210410600	*
1/2"	210410800	*
5/8"	210411000	*
3/4"	210411200	*
1"	210411600	*
1"1/4	210412000	*
1"1/2	210412400	*
2"	210413200	*

Ver precios en p.39 (Conexiones Standard CrIII) // Prix à la p.39 (Embouts Série Standard CrIII) // See prices in p.39 (Standard Serie Fittings CrIII) // Vedere prezzi p.39 (Raccordi Serie Standard CrIII)

Ver precios en p.39 (Conexiones Standard CrIII) // Prix à la p.39 (Embouts Série Standard CrIII) // See prices in p.39 (Standard Serie Fittings CrIII) // Vedere prezzi p.39 (Raccordi Serie Standard CrIII)



## Conexiones Standard Zn/Ni

Embouts série Standard Zn/Ni  
Standard serie fittings Zn/Ni  
Raccordi serie Standard Zn/Ni

### Hembras giratorias rectas BSP cono 60° con junta tórica

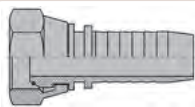

Femelle tournante droite gaz cyl BSP 60° + o'ring  
BSP Swivel female 60° with o'ring  
Femmina diritta BSP sede 60° con o'ring

DN	ROSCA THREAD	REFERENCIA PART N°	€
1/4"	1/4" BSP	G241100404L	2,18
3/8"	3/8" BSP	G241100606L	3,52
1/2"	1/2" BSP	G241100808L	3,40
5/8"	5/8" BSP	G241101010	12,21
3/4"	3/4" BSP	G241101212	6,06
1"	1" BSP	G241101616	10,80
1"	1"1/4 BSP	G241102016L	21,03
1"1/4"	1"1/4 BSP	G241102020	18,09
1"1/4"	1"1/2 BSP	G241102420	31,92
1"1/2"	1"1/2 BSP	G241102424	31,00
1"1/2"	2" BSP	G241103224	53,26
2"	2" BSP	G241103232	49,59

Referencias "...L" con tuerca libre//Les références "...L" sont avec écrou libre//  
The Referencias "...L" are with loose nut//I codici "...L", sono con dado libero

### Hembras giratorias 90° BSP cono 60° con junta tórica

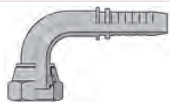

Coude 90° femelle tournante gaz cyl BSP 60° + o'ring  
90° BSP Swivel female 60° cone with o'ring  
Femmina a 90° BSP sede 60° con o'ring

DN	ROSCA THREAD	REFERENCIA PART N°	€
1/4"	1/4" BSP	G241170404L	4,56
3/8"	3/8" BSP	G241170606L	5,10
1/2"	1/2" BSP	G241170808L	7,01
5/8"	5/8" BSP	G241171010	26,63
3/4"	3/4" BSP	G241171212	13,22
1"	1" BSP	G241171616	22,74
1"	1"1/4 BSP	G241172016L	44,08
1"1/4"	1"1/4 BSP	G241172020	40,87
1"1/4"	1"1/2 BSP	G241172420	64,52
1"1/2"	1"1/2 BSP	G241172424	57,40
2"	2" BSP	G241173232	112,78

Referencias "...L" con tuerca libre//Les références "...L" sont avec écrou libre//  
The Referencias "...L" are with loose nut//I codici "...L", sono con dado libero

### Hembras giratorias 45° BSP cono 60° con junta tórica

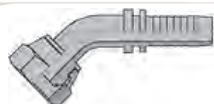

Coude 45° femelle tournante gaz cyl BSP 60° + o'ring  
45° BSP Swivel female 60° cone with o'ring  
Femmina a 45° BSP sede 60° con o'ring

DN	ROSCA THREAD	REFERENCIA PART N°	€
1/4"	1/4" BSP	G241180404L	4,21
3/8"	3/8" BSP	G241180606L	5,41
1/2"	1/2" BSP	G241180808L	6,83
5/8"	5/8" BSP	G241181010	27,09
3/4"	3/4" BSP	G241181212	14,47
1"	1" BSP	G241181616	22,87
1"	1"1/4 BSP	G241182016L	44,08
1"1/4"	1"1/4 BSP	G241182020	40,87
1"1/2"	1"1/2 BSP	G241182424	59,93
1"1/2"	2" BSP	G241183224	123,05
2"	2" BSP	G241183232	101,93

Referencias "...L" con tuerca libre//Les références "...L" sont avec écrou libre//  
The Referencias "...L" are with loose nut//I codici "...L", sono con dado libero

### Macho rosca cilíndrica BSP cono 60°

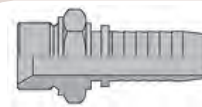

Mâle fixe gaz cyl BSP 60°  
BSP Male parallel 60° cone  
Maschio BSP cilindrico sede 60°

DN	ROSCA THREAD	REFERENCIA PART N°	€
1/4"	1/4" BSP	G241120404	2,10
1/4"	3/8" BSP	G241120604	2,78
5/16"	3/8" BSP	G241120605	2,72
3/8"	3/8" BSP	G241120606	2,35
1/2"	3/8" BSP	G241120608	3,16
3/8"	1/2" BSP	G241120806	3,23
1/2"	1/2" BSP	G241120808	3,35
1/2"	5/8" BSP	G241121008	8,63
5/8"	5/8" BSP	G241121010	8,63
1/2"	3/4" BSP	G241121208	9,70
5/8"	3/4" BSP	G241121210	8,59
3/4"	3/4" BSP	G241121212	5,41
3/4"	1" BSP	G241121612	12,34
1"	1" BSP	G241121616	11,77
1"	1"1/4 BSP	G241122016	27,09
1"1/4"	1"1/4 BSP	G241122020	19,89
1"1/2"	1"1/2 BSP	G241122424	25,25
2"	2" BSP	G241123232	47,96

### Macho rosca cilíndrica BSP asiento plano

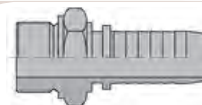

Mâle fixe gaz cyl fond plat  
BSP Male flat seat  
Maschio BSP cilindrico sede piana

DN	ROSCA THREAD	REFERENCIA PART N°	€
1/4"	1/4" BSP	G242120404	3,41
3/8"	3/8" BSP	G242120606	4,45
3/8"	1/2" BSP	G242120806	4,70
1/2"	1/2" BSP	G242120808	5,18

### Macho rosca cónica BSPT

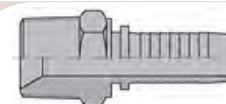

Mâle fixe gaz conique BSPT  
BSPT Male tapered  
Maschio BSPT conico

DN	ROSCA THREAD	REFERENCIA PART N°	€
3/16"	1/8" BSPT	G241140203	2,98
1/4"	1/8" BSPT	G241140204	2,20
1/4"	1/4" BSPT	G241140404	2,30
1/4"	3/8" BSPT	G241140604	3,78
5/16"	3/8" BSPT	G241140605	3,14
3/8"	3/8" BSPT	G241140606	2,44
3/8"	1/2" BSPT	G241140806	3,00
1/2"	1/2" BSPT	G241140808	3,31
5/8"	3/4" BSPT	G241141210	10,47
3/4"	3/4" BSPT	G241141212	5,22
3/4"	1" BSPT	G241141612	13,68
1"	1" BSPT	G241141616	12,18
1"	1"1/4 BSPT	G241142016	24,34
1"1/4"	1"1/4 BSPT	G241142020	19,74
1"1/2"	1"1/2 BSPT	G241142424	23,88
2"	2" BSPT	G241143232	45,46

Embouts série Standard Zn/Ni  
Standard serie fittings Zn/Ni  
Raccordi serie Standard Zn/Ni

## Macho rosca cónica NPT

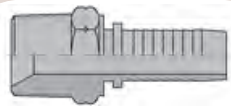

Mâle fixe gaz conique NPT  
NPT Male thread  
Maschio NPT conico

DN	ROSCA THREAD	REFERENCIA PART N°	€
3/16"	1/8" NPT	G241610203	2,76
1/4"	1/8" NPT	G241610204	2,30
1/4"	1/4" NPT	G241610404	1,84
1/4"	3/8" NPT	G241610604	3,12
5/16"	3/8" NPT	G241610605	2,94
3/8"	3/8" NPT	G241610606	2,76
1/2"	3/8" NPT	G241610608	3,62
3/8"	1/2" NPT	G241610806	3,08
1/2"	1/2" NPT	G241610808	3,08
5/8"	1/2" NPT	G241610810	5,44
1/2"	3/4" NPT	G241611208	10,80
3/4"	3/4" NPT	G241611212	5,62
3/4"	1" NPT	G241611612	11,94
1"	1" NPT	G241611616	12,63
1"	1"1/4 NPT	G241612016	21,12
1"1/4"	1"1/4 NPT	G241612020	18,14
1"1/2"	1"1/2 NPT	G241612424	23,88
2"	2" NPT	G241613232	47,29

## Orientable BSP

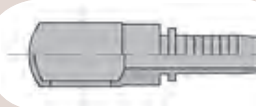

Embout Banjo droit gaz  
Banjo BSP  
Raccordo ad occhio BSP

DN	Ø	REFERENCIA PART N°	€
1/4"	1/4" BSP	G241110404	3,58
5/16"	3/8" BSP	G241110605	4,65
3/8"	3/8" BSP	G241110606	4,53
3/8"	1/2" BSP	G241110806	7,42
1/2"	1/2" BSP	G241110808	7,42
5/8"	5/8" BSP	G241111010	26,88
5/8"	3/4" BSP	G241111210	27,24
3/4"	3/4" BSP	G241111212	27,24
1"	1" BSP	G241111616	67,49

## Macho JIC 37°



Mâle fixe JIC cône 37°  
Male JIC 37° cone  
Maschio JIC 37°

DN	ROSCA THREAD	REFERENCIA PART N°	€
1/4"	7/16" 20h UNF	G241400704	2,05
1/4"	1/2" 20h UNF	G241400804	2,41
1/4"	9/16" 18h UNF	G241400904	2,51
5/16"	9/16" 18h UNF	G241400905	2,37
3/8"	9/16" 18h UNF	G241400906	2,00
3/8"	3/4" 16h UNF	G241401206	2,64
1/2"	3/4" 16h UNF	G241401208	2,82
3/8"	7/8" 14h UNF	G241401406	3,88
1/2"	7/8" 14h UNF	G241401408	3,04
5/8"	7/8" 14h UNF	G241401410	3,74
1/2"	1"1/16 12h UNF	G241401708	7,42
5/8"	1"1/16 12h UNF	G241401710	7,20
3/4"	1"1/16 12h UNF	G241401712	7,34
3/4"	1"1/16 12h UNF	G241402112	7,34
3/4"	1"1/16 12h UNF	G241402116	7,34
1"	1"5/8 12h UNF	G241402616	16,85
1"1/4"	1"5/8 12h UNF	G241402620	18,64
1"1/4"	1"7/8 12h UNF	G241403020	28,01
1"1/2"	1"7/8 12h UNF	G241403024	32,40
2"	2"1/2 12h UNF	G241404032	47,75

## Hembras giratorias rectas JIC 37°



Femelle tournante droite JIC cône 37°  
JIC Swivel female 37° cone  
Femmina diritta JIC 37°

DN	ROSCA THREAD	REFERENCIA PART N°	€
3/16"	7/16" 20h UNF	G241420703	2,30
1/4"	7/16" 20h UNF	G241420704	1,53
1/4"	1/2" 20h UNF	G241420804	1,69
5/16"	1/2" 20h UNF	G241420805	2,85
1/4"	9/16" 18h UNF	G241420904	1,61
5/16"	9/16" 18h UNF	G241420905	1,84
3/8"	9/16" 18h UNF	G241420906	1,86
3/8"	3/4" 16h UNF	G241421206	2,39
1/2"	3/4" 16h UNF	G241421208	2,59
3/8"	7/8" 14h UNF	G241421406	4,08
1/2"	7/8" 14h UNF	G241421408	3,09
5/8"	7/8" 14h UNF	G241421410	3,56
1/2"	1"1/16 12h UNF	G241421708	6,63
5/8"	1"1/16 12h UNF	G241421710	4,67
3/4"	1"1/16 12h UNF	G241421712	4,86
1"	1"1/16 12h UNF	G241421716	13,74
3/4"	1"5/16 12h UNF	G241422112	8,93
1"	1"5/16 12h UNF	G241422116	8,75
1"	1"5/8 12h UNF	G241422616	17,94
1"1/4"	1"5/8 12h UNF	G241422620	16,46
1"1/4"	1"7/8 12h UNF	G241423020	34,67
1"1/2"	1"7/8 12h UNF	G241423024	28,32
2"	2"1/2 12h UNF	G241424032	63,77

## Conexiones Standard Zn/Ni

Embouts série Standard Zn/Ni  
Standard serie fittings Zn/Ni  
Raccordi serie Standard Zn/Ni

Hoses

Flexible hose fittings

Stainless steel hoses  
and fittings

Low pressure

Air conditioned hoses  
and fittings

Measuring flow

Machines for  
mounting flexibles

### Hembras giratorias 90° JIC 37°

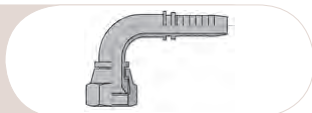

Coude 90° femelle tournante cône JIC 37°  
90° JIC Swivel female 37° cone  
Femmina a 90° JIC 37°

DN	ROSCA THREAD	REFERENCIA PART N°	€
3/16"	7/16" 20h UNF	<b>G241380703</b>	<b>4,34</b>
1/4"	7/16" 20h UNF	<b>G241380704</b>	<b>3,12</b>
1/4"	1/2" 20h UNF	<b>G241380804</b>	<b>3,93</b>
1/4"	9/16" 18h UNF	<b>G241380904</b>	<b>3,56</b>
5/16"	9/16" 18h UNF	<b>G241380905</b>	<b>3,73</b>
3/8"	9/16" 18h UNF	<b>G241380906</b>	<b>3,73</b>
3/8"	3/4" 16h UNF	<b>G241381206</b>	<b>4,59</b>
1/2"	3/4" 16h UNF	<b>G241381208</b>	<b>5,10</b>
3/8"	7/8" 14h UNF	<b>G241381406</b>	<b>7,14</b>
1/2"	7/8" 14h UNF	<b>G241381408</b>	<b>5,10</b>
5/8"	7/8" 14h UNF	<b>G241381410</b>	<b>9,14</b>
1/2"	1"1/16 12h UNF	<b>G241381708</b>	<b>13,78</b>
5/8"	1"1/16 12h UNF	<b>G241381710</b>	<b>9,59</b>
3/4"	1"1/16 12h UNF	<b>G241381712</b>	<b>10,05</b>
3/4"	1"5/16 12h UNF	<b>G241382112</b>	<b>19,29</b>
1"	1"5/16 12h UNF	<b>G241382116</b>	<b>18,54</b>
1"	1"5/8 12h UNF	<b>G241382616</b>	<b>39,73</b>
1"1/4	1"5/8 12h UNF	<b>G241382620</b>	<b>33,76</b>
1"1/4	1"7/8 12h UNF	<b>G241383020</b>	<b>58,66</b>
1"1/2	1"7/8 12h UNF	<b>G241383024</b>	<b>56,37</b>
2"	2"1/2 12h UNF	<b>G241384032</b>	<b>117,34</b>

### Hembras giratorias 45° JIC 37°

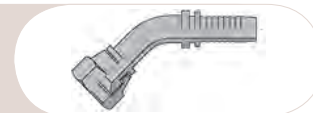

Coude 45° femelle tournante cône JIC 37°  
45° JIC swivel female 37° cone  
Femmina a 45° JIC 37°

DN	ROSCA THREAD	REFERENCIA PART N°	€
1/4"	7/16" 20h UNF	<b>G241390704</b>	<b>3,25</b>
1/4"	1/2" 20h UNF	<b>G241390804</b>	<b>4,64</b>
1/4"	9/16" 18h UNF	<b>G241390904</b>	<b>3,82</b>
5/16"	9/16" 18h UNF	<b>G241390905</b>	<b>5,20</b>
3/8"	9/16" 18h UNF	<b>G241390906</b>	<b>3,82</b>
3/8"	3/4" 16h UNF	<b>G241391206</b>	<b>4,74</b>
1/2"	3/4" 16h UNF	<b>G241391208</b>	<b>5,58</b>
1/2"	7/8" 14h UNF	<b>G241391408</b>	<b>6,92</b>
5/8"	7/8" 14h UNF	<b>G241391410</b>	<b>8,10</b>
1/2"	1"1/16 12h UNF	<b>G241391708</b>	<b>14,93</b>
5/8"	1"1/16 12h UNF	<b>G241391710</b>	<b>10,19</b>
3/4"	1"1/16 12h UNF	<b>G241391712</b>	<b>13,54</b>
3/4"	1"5/16 12h UNF	<b>G241392112</b>	<b>18,33</b>
1"	1"5/16 12h UNF	<b>G241392116</b>	<b>17,70</b>
1"	1"5/8 12h UNF	<b>G241392616</b>	<b>37,19</b>
1"1/4	1"5/8 12h UNF	<b>G241392620</b>	<b>36,24</b>
1"1/4	1"7/8 12h UNF	<b>G241393020</b>	<b>60,19</b>
1"1/2	1"7/8 12h UNF	<b>G241393024</b>	<b>61,21</b>
2"	2"1/2 12h UNF	<b>G241394032</b>	<b>117,34</b>

Embouts série Standard Zn/Ni  
Standard serie fittings Zn/Ni  
Raccordi serie Standard Zn/Ni

## Hembras giratorias Métricas cono 24° con junta tórica

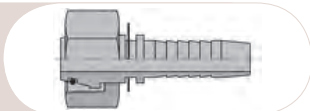

Femelle tournante droite Métrique cône 24° + o'ring Série Allemagne  
Metric swivel female 24° cone with o'ring  
Femmina Metrica sede 24° con o'ring

DN	TUBO PIPE	SERIE	ROSCA THREAD	REFERENCIA PART N°	€
3/16"	6	L	12X1,5	G24804120603	2,55
1/4"	6	L	12X1,5	G24804120604	2,81
1/4"	8	L	14X1,5	G24804140804	1,60
1/4"	10	L	16X1,5	G24804161004	1,84
5/16"	10	L	16X1,5	G24804161005	1,67
3/8"	10	L	16X1,5	G24804161006	2,70
1/4"	12	L	18X1,5	G24804181204	2,70
5/16"	12	L	18X1,5	G24804181205	2,50
3/8"	12	L	18X1,5	G24804181206	1,93
3/8"	15	L	22X1,5	G24804221506	3,43
1/2"	15	L	22X1,5	G24804221508	2,81
1/2"	18	L	26X1,5	G24804261808	6,17
5/8"	18	L	26X1,5	G24804261810	4,60
3/4"	22	L	30X2	G24804302212	6,19
1"	28	L	36X2	G24804362816	9,41
1" 1/4	35	L	45X2	G24804453520	16,94
1" 1/2	42	L	52X2	G24804524224	24,21
3/16"	8	S	16X1,5	G24804160803	3,93
1/4"	8	S	16X1,5	G24804160804	1,99
1/4"	10	S	18X1,5	G24804181004	2,18
5/16"	12	S	20X1,5	G24804201205	2,35
3/8"	12	S	20X1,5	G24804201206	2,33
3/8"	14	S	22X1,5	G24804221406	3,31
1/2"	16	S	24X1,5	G24804241608	3,50
5/8"	20	S	30X2	G24804302010	6,06
3/4"	20	S	30X2	G24804302012	8,15
3/4"	25	S	36X2	G24804362512	9,89
1"	25	S	36X2	G24804362516	16,20
1"	30	S	42X2	G24804423016	16,05
1" 1/4	38	S	52X2	G24804523820	22,98

## Orientable Métrico

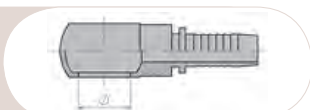

Embout Banjo droit Métrique  
Banjo Metric  
Raccordo ad occhio Metrico

DN	Ø	REFERENCIA PART N°	€
1/4"	M12X1.5	G241161204	3,91
1/4"	M14X1.5	G241161404	4,06
5/16"	M14X1.5	G241161405	4,01
3/8"	M14X1.5	G241161406	4,09
5/16"	M16X1.5	G241161605	4,74
3/8"	M16X1.5	G241161606	5,00
3/8"	M18X1.5	G241161806	6,06
1/2"	M18X1.5	G241161808	6,06
1/2"	M22X1.5	G241162208	8,23
5/8"	M22X1.5	G241162210	13,50
5/8"	M26X1.5	G241162610	25,77
3/4"	M30X2	G241163012	54,88

## Hembras giratorias 90° Métricas cono 24° con junta tórica

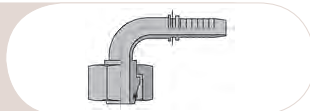

Coude 90° femelle tournante Métrique cône 24° + o'ring Série Allemagne  
90° Metric swivel female 24° cone with o'ring  
Femmina Metrica a 90° sede 24° con o'ring

DN	TUBO PIPE	SERIE	ROSCA THREAD	REFERENCIA PART N°	€
3/16"	6	L	12X1,5	G24305120603	5,10
1/4"	6	L	12X1,5	G24305120604	4,85
1/4"	8	L	14X1,5	G24305140804	2,97
1/4"	10	L	16X1,5	G24305161004	3,56
5/16"	10	L	16X1,5	G24305161005	3,47
3/8"	10	L	16X1,5	G24305161006	5,62
5/16"	12	L	18X1,5	G24305181205	4,34
3/8"	12	L	18X1,5	G24305181206	3,55
1/2"	15	L	22X1,5	G24305221508	5,00
5/8"	18	L	26X1,5	G24305261810	7,95
3/4"	22	L	30X2	G24305302212	10,45
1"	28	L	36X2	G24305362816	19,55
1" 1/4	35	L	45X2	G24305453520	33,30
1" 1/2	42	L	52X2	G24305524224	52,80
1/4"	8	S	16X1,5	G24305160804	3,88
1/4"	10	S	18X1,5	G24305181004	4,19
5/16"	12	S	20X1,5	G24305201205	4,34
3/8"	12	S	20X1,5	G24305201206	4,34
3/8"	14	S	22X1,5	G24305221406	5,60
1/2"	16	S	24X1,5	G24305241608	5,61
5/8"	20	S	30X2	G24305302010	9,50
3/4"	20	S	30X2	G24305302012	12,75
3/4"	25	S	36X2	G24305362512	16,68
1"	25	S	36X2	G24305362516	27,74
1"	30	S	42X2	G24305423016	25,00
1" 1/4	38	S	52X2	G24305523820	43,88

## Hembras giratorias 45° Métricas cono 24° con junta tórica

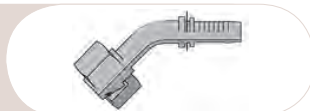

Coude 45° femelle tournante Métrique cône 24° + o'ring Série Allemagne  
45° Metric swivel female 24° cone with o'ring  
Femmina Metrica a 45° sede 24° con o'ring

DN	TUBO PIPE	SERIE	ROSCA THREAD	REFERENCIA PART N°	€
1/4"	8	L	14X1,5	G24306140804	3,07
1/4"	10	L	16X1,5	G24306161004	4,18
5/16"	10	L	16X1,5	G24306161005	3,47
3/8"	10	L	16X1,5	G24306161006	6,63
3/8"	12	L	18X1,5	G24306181206	3,53
1/2"	15	L	22X1,5	G24306221508	5,00
5/8"	18	L	26X1,5	G24306261810	8,17
3/4"	22	L	30X2	G24306302212	10,45
1"	28	L	36X2	G24306362816	20,62
1" 1/4	35	L	45X2	G24306453520	33,76
1" 1/2	42	L	52X2	G24306524224	46,84
1/4"	8	S	16X1,5	G24306160804	4,08
1/4"	10	S	18X1,5	G24306181004	5,42
5/16"	12	S	20X1,5	G24306201205	4,59
3/8"	12	S	20X1,5	G24306201206	5,28
3/8"	14	S	22X1,5	G24306221406	6,48
1/2"	16	S	24X1,5	G24306241608	6,11
5/8"	20	S	30X2	G24306302010	11,30
3/4"	20	S	30X2	G24306302012	15,30
3/4"	25	S	36X2	G24306362512	16,68
1"	25	S	36X2	G24306362516	26,02
1"	30	S	42X2	G24306423016	25,49
1" 1/4	38	S	52X2	G24306523820	43,88

## Conexiones Standard Zn/Ni

Embouts série Standard Zn/Ni  
Standard serie fittings Zn/Ni  
Raccordi serie Standard Zn/Ni

Hoses

Flexible hose fittings

Stainless steel hoses and fittings

Low pressure

Air conditioned hoses and fittings

Measuring flow

Machines for mounting flexibles

### Machos Métricos cono 24°

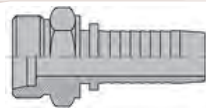

Mâle fixe Métrique cône 24°

Metric stud 24° cone

Maschio Metrico sede 24°

DN	TUBO PIPE	SERIE	ROSCA THREAD	REFERENCIA PART N°	€
3/16"	6	L	12X1,5	G24203120603	2,81
1/4"	6	L	12X1,5	G24203120604	2,55
1/4"	8	L	14X1,5	G24203140804	1,64
1/4"	10	L	16X1,5	G24203161004	2,30
5/16"	10	L	16X1,5	G24203161005	1,74
3/8"	10	L	16X1,5	G24203161006	1,93
1/4"	12	L	18X1,5	G24203181204	3,31
5/16"	12	L	18X1,5	G24203181205	2,48
3/8"	12	L	18X1,5	G24203181206	1,71
3/8"	15	L	22X1,5	G24203221506	3,29
1/2"	15	L	22X1,5	G24203221508	2,57
1/2"	18	L	26X1,5	G24203261808	6,80
5/8"	18	L	26X1,5	G24203261810	3,73
3/4"	22	L	30X2	G24203302212	6,40
1"	28	L	36X2	G24203362816	11,57
1" 1/4	35	L	45X2	G24203453520	15,55
1" 1/2	42	L	52X2	G24203524224	24,80
1/4"	8	S	16X1,5	G24203160804	2,59
1/4"	10	S	18X1,5	G24203181004	2,59
5/16"	10	S	18X1,5	G24203181005	3,07
3/8"	10	S	18X1,5	G24203181006	3,67
5/16"	12	S	20X1,5	G24203201205	2,68
3/8"	12	S	20X1,5	G24203201206	2,80
3/8"	14	S	22X1,5	G24203221406	3,44
1/2"	16	S	24X1,5	G24203241608	4,01
5/8"	20	S	30X2	G24203302010	6,49
3/4"	20	S	30X2	G24203302012	8,96
3/4"	25	S	36X2	G24203362512	10,66
1"	25	S	36X2	G24203362516	14,25
1"	30	S	42X2	G24203423016	16,80
1" 1/4	38	S	52X2	G24203523820	24,24

### Espiga lisa recta Métrica

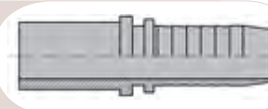

Embout lisse droit Métrique

Metric standpipe

Estremitá tubolare diritta Metrica

DN	TUBO PIPE	REFERENCIA PART N°	€
3/16"	6	G241580603	2,35
1/4"	6	G241580604	1,34
1/4"	8	G241580804	1,47
3/8"	10	G241581006	1,40
3/8"	12	G241581206	1,38
3/8"	15	G241581506	2,57
1/2"	15	G241581508	1,99
1/2"	18	G241581808	3,23
5/8"	18	G241581810	3,49
3/4"	22	G241582212	6,01
1"	28	G241582816	8,32
1" 1/4	35	G241583520	14,23
1" 1/2	42	G241584224	19,29
1/4"	10	G241581004	1,34
1/4"	12	G241581204	2,11
5/16"	12	G241581205	1,56
3/8"	14	G241581406	1,74
1/2"	14	G241581408	2,81
1/2"	16	G241581608	2,17
5/8"	20	G241582010	5,24
3/4"	20	G241582012	4,26
3/4"	25	G241582512	5,81
1"	25	G241582516	10,03
1"	30	G241583016	10,34
1" 1/4	38	G241583820	14,00

### Espiga lisa a 90° Métrica

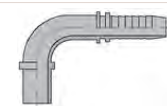

Embout lisse coude 90° Métrique

90° Metric standpipe

Estremitá tubolare a 90° Metrica

DN	TUBO PIPE	REFERENCIA PART N°	€
3/16"	6	G242580603	4,79
1/4"	6	G242580604	3,58
1/4"	8	G242580804	3,91
3/8"	10	G242581006	5,22
3/8"	12	G242581206	4,28
1/2"	15	G242581508	6,67
1/2"	18	G242581808	6,65
5/8"	18	G242581810	10,93
5/8"	22	G242582210	13,28
3/4"	22	G242582212	10,46
1"	28	G242582816	26,41
1" 1/4	35	G242583520	34,90
1/4"	10	G242581004	3,91
5/16"	12	G242581205	5,29
3/8"	14	G242581406	4,83
1/2"	14	G242581408	7,03
1/2"	16	G242581608	7,50
5/8"	20	G242582010	14,69
3/4"	20	G242582012	12,18
3/4"	25	G242582512	14,97
1"	30	G242583016	25,71

## Conexiones Standard Zn/Ni

Embouts série Standard Zn/Ni  
Standard serie fittings Zn/Ni  
Raccordi serie Standard Zn/Ni

### Hembras giratorias Métricas cono 24°/60°



Femelle tournante Métrique cône 24°-60°  
Metric swivel female 24°/60° cone  
Femmina Metrica Multiseal 24°/60°

DN	TUBO PIPE	ROSCA THREAD	REFERENCIA PART N°	€
1/4"	8L	M14X1.5	G244049511	1,60
1/4"	10L	M16X1.5	G244049520	2,09
5/16"	10L	M16X1.5	G244049523	1,71
3/8"	10L	M16X1.5	G244049524	2,35
5/16"	12L	M18X1.5	G244049525	3,27
3/8"	12L	M18X1.5	G244049535	1,99
3/8"	15L	M22X1.5	G244049552	3,31
1/2"	15L	M22X1.5	G244049555	2,65
5/8"	18L	M26X1.5	G244049571	4,65

### Hembras giratorias 90° Métricas cono 24°/60°

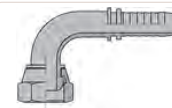

Femelle tournante coude 90° Métrique cône 24°-60°  
90° Metric swivel female 24°/60° cone  
Femmina Metrica a 90° Multiseal 24°/60°

DN	TUBO PIPE	ROSCA THREAD	REFERENCIA PART N°	€
1/4"	8L	M14X1.5	G244059511	3,21
1/4"	10L	M16X1.5	G244059520	4,55
5/16"	10L	M16X1.5	G244059523	4,04
3/8"	10L	M16X1.5	G244059524	6,36
5/16"	12L	M18X1.5	G244059525	5,97
3/8"	12L	M18X1.5	G244059535	4,13
3/8"	15L	M22X1.5	G244059552	8,17
1/2"	15L	M22X1.5	G244059555	5,88
5/8"	18L	M26X1.5	G244059571	12,73

### Hembras giratorias 45° Métricas cono 24°/60°

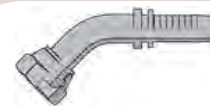

Femelle tournante coude 45° Métrique cône 24°-60°  
45° Metric swivel female 24°/60° cone  
Femmina Metrica a 45° Multiseal 24°/60°

DN	TUBO PIPE	ROSCA THREAD	REFERENCIA PART N°	€
1/4"	8L	M14X1.5	G244069511	3,87
5/16"	10L	M16X1.5	G244069523	4,66
3/8"	10L	M16X1.5	G244069524	6,36
5/16"	12L	M18X1.5	G244069525	5,97
3/8"	12L	M18X1.5	G244069535	4,01
1/2"	15L	M22X1.5	G244069555	7,26
5/8"	18L	M26X1.5	G244069571	13,96

## Conexiones Standard Zn/Ni

Embouts série Standard Zn/Ni  
Standard serie fittings Zn/Ni  
Raccordi serie Standard Zn/Ni

Hoses

Flexible hose fittings

Stainless steel hoses  
and fittings

Low pressure

Air conditioned hoses  
and fittings

Measuring flow

Machines for  
mounting flexibles

### Hembra giratoria recta ORFS asiento plano

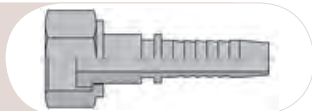

Femelle tournante série Caterpillar-ORFS fond plat  
ORFS Swivel female straight flat seat  
Femmina diritta sede piana ORFS

DN	ROSCA THREAD	REFERENCIA PART N°	€
1/4"	9/16" 18h UNF	G449000404	2,76
1/4"	11/16" 16h UNF	G449000604	4,09
5/16"	11/16" 16h UNF	G449000605	4,22
3/8"	11/16" 16h UNF	G449000606	3,45
3/8"	13/16" 16h UNF	G449000806	4,96
1/2"	13/16" 16h UNF	G449000808	4,13
1/2"	1" 14h UNF	G449001008	6,21
5/8"	1" 14h UNF	G449001010	6,43
1/2"	1" 3/16 12h UNF	G449001208	13,74
3/4"	1" 3/16 12h UNF	G449001212	8,72
3/4"	1" 7/16 12h UNF	G449001612	20,30
1"	1" 7/16 12h UNF	G449001616	18,37
1"1/4	1" 11/16 12h UNF	G449002020	24,34
1"1/2	2" 12h UNF	G449002424	40,87

### Hembra giratoria 90° ORFS asiento plano

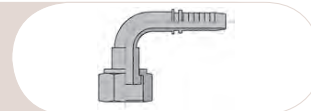

Femelle tournante coude 90° série Caterpillar-ORFS fond plat  
90° ORFS Swivel female flat seat  
Femmina a 90° sede piana ORFS

DN	ROSCA THREAD	REFERENCIA PART N°	€
1/4"	9/16" 18h UNF	G449070404	5,48
5/16"	11/16" 16h UNF	G449070605	8,17
3/8"	11/16" 16h UNF	G449070606	4,96
3/8"	13/16" 16h UNF	G449070806	7,71
1/2"	13/16" 16h UNF	G449070808	6,52
1/2"	1-14h UNF	G449071008	15,61
5/8"	1" 14h UNF	G449071010	12,86
1/2"	1 3/16-12h UNF	G449071208	23,95
3/4"	1" 3/16 12h UNF	G449071212	15,67
3/4"	1" 7/16 12h UNF	G449071612	27,71
1"	1" 7/16 12h UNF	G449071616	28,47
1"1/4	1" 11/16 12h UNF	G449072020	44,54

### Machos ORFS asiento plano con junta tórica

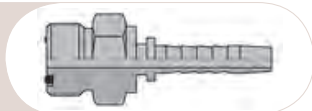

Mâle fixe série Caterpillar-ORFS fond plat + o'ring  
ORFS Male flat seat + o'ring  
Maschio ORFS sede piana con o'ring

DN	ROSCA THREAD	REFERENCIA PART N°	€
1/4"	9/16" 18h UNF	G449120404	6,11
1/4"	11/16" 16h UNF	G449120604	11,35
5/16"	11/16" 16h UNF	G449120605	11,35
3/8"	11/16" 16h UNF	G449120606	6,21
1/2"	13/16" 16h UNF	G449120808	6,41
5/8"	1" 14h UNF	G449121010	13,32
3/4"	1" 3/16 12h UNF	G449121212	14,66
1"	1" 7/16 12h UNF	G449121616	24,34
1"1/4	1" 11/16-12h UNF	G449122020	27,09

### Hembra giratoria 45° ORFS asiento plano

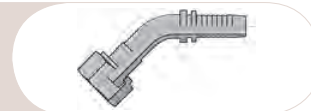

Femelle tournante coude 45° série Caterpillar-ORFS fond plat  
45° ORFS Swivel female  
Femmina a 45° sede piana ORFS

DN	ROSCA THREAD	REFERENCIA PART N°	€
1/4"	9/16" 18h UNF	G449080404	5,14
3/8"	11/16" 16h UNF	G449080606	5,23
3/8"	13/16" 16h UNF	G449080806	8,41
1/2"	13/16" 16h UNF	G449080808	6,67
1/2"	1" - 14h UNF	G449081008	13,68
5/8"	1" 14h UNF	G449081010	12,86
3/4"	1" 3/16 12h UNF	G449081212	16,03
1"	1" 7/16 12h UNF	G449081616	28,01
1"1/4	1" 11/16 12h UNF	G449082020	44,54

# Conexiones Standard Zn/Ni

Embouts série Standard Zn/Ni  
Standard serie fittings Zn/Ni  
Raccordi serie Standard Zn/Ni

## Brida recta SAE 3000 PSI

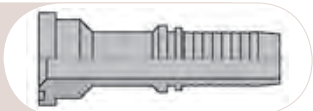

Bride SAE droite série 3000 PSI  
3000 PSI SAE Straight flange  
Flangia diritta SAE 3000 PSI

DN	Ø	REFERENCIA PART N°	€
1/2"	30.2	G241820808	10,52
1/2"	38.1	G241821208	15,15
5/8"	38.1	G241821210	20,66
3/4"	38.1	G241821212	12,14
3/4"	44.5	G241821612	16,51
1"	44.5	G241821616	16,81
1"	50.8	G241822016	23,42
1 1/4"	50.8	G241822020	23,51
1 1/4"	60.3	G241822420	33,06
1 1/2"	60.3	G241822424	33,98
1 1/2"	71.4	G241823224	56,02
2"	71.4	G241823232	57,85

## Brida recta SAE 6000 PSI

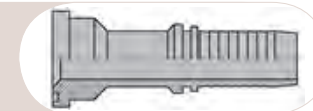

Bride SAE droite série 6000 PSI  
6000 PSI SAE Straight flange  
Flangia diritta SAE 6000 PSI

DN	Ø	REFERENCIA PART N°	€
1/2"	31.8	G242820808	12,95
1/2"	41.3	G242821208	18,83
5/8"	41.3	G242821210	22,04
3/4"	41.3	G242821212	15,85
3/4"	47.6	G242821612	19,74
1"	47.6	G242821616	20,98
1"	54	G242822016	27,09
1 1/4"	54	G242822020	30,88
1 1/4"	63.5	G242822420	44,91
1 1/2"	63.5	G242822424	44,54
1 1/2"	79.4	G242823224	84,94
2"	79.4	G242823232	82,86

## Brida a 90° SAE 3000 PSI

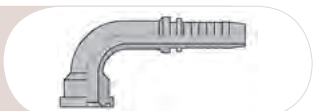

Bride SAE coude 90° série 3000 PSI  
3000 PSI SAE 90° Flange  
Flangia a 90° SAE 3000 PSI

DN	Ø	REFERENCIA PART N°	€
1/2"	30.2	G241830808	13,70
1/2"	38.1	G241831208	20,66
5/8"	38.1	G241831210	24,80
3/4"	38.1	G241831212	16,86
3/4"	44.5	G241831612	20,20
1"	44.5	G241831616	23,97
1"	50.8	G241832016	35,57
1 1/4"	50.8	G241832020	38,46
1 1/4"	60.3	G241832420	56,02
1 1/2"	60.3	G241832424	57,40
1 1/2"	71.4	G241833224	103,73
2"	71.4	G241833232	112,41

## Brida a 90° SAE 6000 PSI



Bride SAE coude 90° série 6000 PSI  
6000 PSI SAE 90° Flange  
Flangia a 90° SAE 6000 PSI

DN	Ø	REFERENCIA PART N°	€
1/2"	31.8	G242830808	14,90
1/2"	41.3	G242831208	23,88
5/8"	41.3	G242831210	27,18
3/4"	41.3	G242831212	18,62
3/4"	47.6	G242831612	24,80
1"	47.6	G242831616	26,96
1"	54	G242832016	40,22
1 1/4"	54	G242832020	43,75
1 1/4"	63.5	G242832420	72,55
1 1/2"	63.5	G242832424	77,60
1 1/2"	79.4	G242833224	143,26

## Brida a 45° SAE 3000 PSI

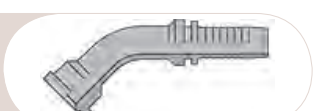

Bride SAE coude 45° série 3000 PSI  
3000 PSI SAE 45° Flange  
Flangia a 45° SAE 3000 PSI

DN	Ø	REFERENCIA PART N°	€
1/2"	30.2	G241840808	15,61
1/2"	38.1	G241841208	21,58
5/8"	38.1	G241841210	33,06
3/4"	38.1	G241841212	16,53
3/4"	44.5	G241841612	20,44
1"	44.5	G241841616	21,58
1"	50.8	G241842016	29,85
1 1/4"	50.8	G241842020	32,38
1 1/4"	60.3	G241842420	50,75
1 1/2"	60.3	G241842424	53,26
1 1/2"	71.4	G241843224	98,72
2"	71.4	G241843232	96,42

## Brida a 45° SAE 6000 PSI

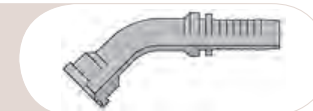

Bride SAE coude 45° série 6000 PSI  
6000 PSI SAE 45° Flange  
Flangia a 45° SAE 6000 PSI

DN	Ø	REFERENCIA PART N°	€
1/2"	31.8	G242840808	16,53
1/2"	41.3	G242841208	23,88
5/8"	41.3	G242841210	35,82
3/4"	41.3	G242841212	18,70
3/4"	47.6	G242841612	25,05
1"	47.6	G242841616	24,34
1"	54	G242842016	38,11
1 1/4"	54	G242842020	41,42
1 1/4"	63.5	G242842420	66,76
1 1/2"	63.5	G242842424	75,46
1 1/2"	79.4	G242843224	142,74
2"	79.4	G242843232	133,16



## Conexiones Standard Zn/Ni

Embouts série Standard Zn/Ni  
Standard serie fittings Zn/Ni  
Raccordi serie Standard Zn/Ni

Hoses

Flexible hose fittings

Stainless steel hoses  
and fittings

Low pressure

Air conditioned hoses  
and fittings

Measuring flow

Machines for  
mounting flexibles

### Brida recta Caterpillar 9000 PSI

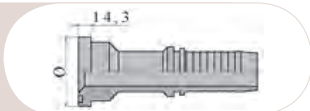

Bride tournante droite Caterpillar série 9000 PSI  
9000 PSI Caterpillar straight Flange  
Flangia diritta Caterpillar

DN	Ø	REFERENCIA PART N°	€
3/4"	41.3	G442821212	20,02
3/4"	47.6	G442821612	25,95
1"	47.6	G442821616	26,13
1"	54	G442822016	38,94
1"1/4	54	G442822020	38,94
1"1/2	63.5	G442822424	57,25

### Brida a 90° Caterpillar 9000 PSI

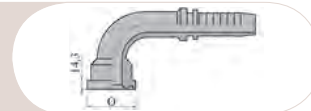

Bride tournante coude 90° Caterpillar série 9000 PSI  
9000 PSI Caterpillar 90° Flange  
Flangia a 90° Caterpillar

DN	Ø	REFERENCIA PART N°	€
3/4"	41.3	G442831212	29,07
3/4"	47.6	G442831612	44,43
1"	47.6	G442831616	37,52
1"	54	G442832016	51,33
1"1/4	54	G442832020	59,23
1"1/2	63.5	G442832424	86,16

### Brida a 45° Caterpillar 9000 PSI

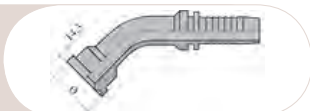

Bride tournante coude 45° Caterpillar série 9000 PSI  
9000 PSI Caterpillar 45° Flange  
Flangia a 45° Caterpillar

DN	Ø	REFERENCIA PART N°	€
3/4"	41.3	G442841212	29,07
3/4"	47.6	G442841612	44,43
1"	47.6	G442841616	38,28
1"	54	G442842016	57,63
1"1/4	54	G442842020	58,61
1"1/2	63.5	G442842424	82,37

## Conexiones Interlock Zn/Ni

Embouts à sertir Interlock Zn/Ni  
Interlock serie fittings Zn/Ni  
Raccordi serie Interlock Zn/Ni

73

### Casquillos 4SH



Juqe à sertir DIN 20023 4SH  
Ferrules DIN 20023-4SH  
Boccola Interlock 4SH

DN	Descripción Description	REFERENCIA PART N°	€
3/4"	4SH / R13 / R15	A610101200	6,30
1"	4SH / R13 / R15	A610101600	10,51
1"1/4	4SH	A610102000	18,14
1"1/2	4SH	A610102400	27,37
2"	4SH	A610103200	46,84

### Casquillos R13-R15



Juqe à sertir DIN 20023 R13/R15  
Ferrules SAE 100 R13/R15  
Boccola Interlock R13/R15

DN	Descripción Description	REFERENCIA PART N°	€
1"1/4	R13 / R15	610102000	21,90
1"1/2	R13 / R15	610102400	38,86
2"	R13	610103200	53,23

### Hembras giratorias rectas BSP cono 60°



Femelle tournante gaz cyl BSP 60° + o'ring  
BSP Swivel female 60° cone  
Femmina diritta BSP sede 60° con o'ring

DN	ROSCA THREAD	REFERENCIA PART N°	€
3/4"	3/4" BSP	641001212	14,69
1"	1" BSP	641001616	20,57
1"1/4	1"1/4 BSP	641002020	31,68
1"1/2	1"1/2 BSP	641002424	39,95
2"	2" BSP	641003232	78,97

### Hembras giratorias 45° BSP cono 60°

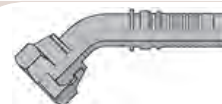

Femelle tournante coude 45° gaz cyl BSP 60° + o'ring  
45° BSP Swivel female 60° cone  
Femmina a 45° BSP sede 60° con o'ring

DN	ROSCA THREAD	REFERENCIA PART N°	€
3/4"	3/4" BSP	641081212	27,55
1"	1" BSP	641081616	38,37
1"1/4	1"1/4 BSP	641082020	57,07
1"1/2	1"1/2 BSP	641082424	85,11
2"	2" BSP	641083232	177,10

### Hembras giratorias 90° BSP cono 60°

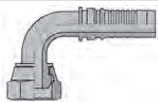

Femelle tournante coude 90° gaz cyl BSP 60°+ o'ring  
90° BSP Swivel female 60° cone  
Femmina a 90° BSP sede 60° con o'ring

DN	ROSCA THREAD	REFERENCIA PART N°	€
3/4"	3/4" BSP	641071212	24,14
1"	1" BSP	641071616	36,73
1"1/4	1"1/4 BSP	641072020	51,65
1"1/2	1"1/2 BSP	641072424	90,03
2"	2" BSP	641073232	152,67

### Macho rosca cilíndrica BSP cono 60°

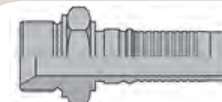

Mâle fixe gaz cyl BSP 60°  
BSP Male 60° cone  
Maschio cilindrico BSP sede 60°

DN	ROSCA THREAD	REFERENCIA PART N°	€
3/4"	3/4" BSP	641121212	15,74
1"	1" BSP	641121616	21,65
1"1/4	1"1/4 BSP	641122020	33,45
1"1/2	1"1/2 BSP	641122424	40,83
2"	2" BSP	641123232	81,17

Por razones logísticas y de producción, estos productos se suministrarán según disponibilidad (Zn/Ni; CrIII). Las referencias más estándar (equivalentes a la serie B, ver págs. (56-58), se suministrarán habitualmente en Zn/Ni. / Pour des raisons logistiques et de fabrication, les produits (Zn/Ni; CrIII) seront fournis selon disponibilité. Les références standard, équivalentes à la série B, voir pages (56-58), seront fournies normalement en Zn/Ni. / For logistics and manufacturing reasons, products (Zn/Ni; CrIII) will be supplied upon availability, Standard references, equivalent to B series, see pages (56-58), will, usually, be supplied in Zn/Ni. / Per ragioni di logistica e di produzione, questi articoli saranno forniti secondo la disponibilità (Zn/Ni; CrIII) i codici più standard (equivalenti alla serie B, vedere pagine (56-58), saranno forniti abitualmente in Zn/Ni.

\* Consultar | Sur demande | On request | Su richiesta

Hoses

Flexible hose fittings

Stainless steel hoses  
and fittings

Low pressure

Air conditioned hoses  
and fittings

Measuring flow

Machines for  
mounting flexibles

## Conexiones Interlock Zn/Ni

Embouts à sertir Interlock Zn/Ni  
Interlock serie fittings Zn/Ni  
Raccordi serie Interlock Zn/Ni

Hoses

### Macho rosca NPT



Mâle fixe NPT

NPT Male thread

Maschio conico NPT

DN	ROSCA THREAD	REFERENCIA PART N°	€
3/4"	3/4" NPT	641611212	15,74
1"	1" NPT	641611616	20,66
1"1/4	1"1/4 NPT	641612020	30,01
1"1/2	1"1/2 NPT	641612424	36,41
2"	2" NPT	641613232	69,18

Flexible hose fittings

Stainless steel hoses  
and fittings

### Hembras giratorias rectas JIC 37°



Femelle tournante JIC 37°

JIC 37° Swivel female

Femmina diritta JIC 37°

DN	ROSCA THREAD	REFERENCIA PART N°	€
3/4"	1"1/16 12h UNF	641421712	15,72
1"	1"5/16 12h UNF	641422116	21,90
1"1/4	1"5/8 12h UNF	641422620	32,49
1"1/2	1"7/8 12h UNF	641423024	45,04
2"	2"1/2 12h UNF	641424032	79,54

Low pressure

### Hembras giratorias 90° JIC 37°

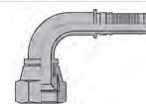

Femelle tournante coude 90° JIC 37°

90° JIC 37° Swivel female

Femmina a 90° JIC 37°

DN	ROSCA THREAD	REFERENCIA PART N°	€
3/4"	1"1/16 12h UNF	641381712	28,28
1"	1"5/16 12h UNF	641382116	41,82
1"1/4	1"5/8 12h UNF	641382620	61,50
1"1/2	1"7/8 12h UNF	641383024	100,73
2"	2"1/2 12h UNF	641384032	178,26

Air conditioned hoses  
and fittings

Measuring flow

### Hembras giratorias 45° JIC 37°

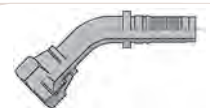

Femelle tournante coude 45° JIC 37°

45° JIC 37° Swivel female

Femmina a 45° JIC 37°

DN	ROSCA THREAD	REFERENCIA PART N°	€
3/4"	1"1/16 12h UNF	641391712	30,01
1"	1"5/16 12h UNF	641392116	37,39
1"1/4	1"5/8 12h UNF	641392620	60,41
1"1/2	1"7/8 12h UNF	641393024	100,73
2"	2"1/2 12h UNF	641394032	178,26

Machines for  
mounting flexibles

### Macho JIC 37°

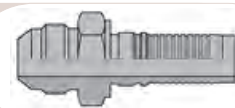

Mâle fixe JIC 37°

JIC 37° male

Maschio JIC 37°

DN	ROSCA THREAD	REFERENCIA PART N°	€
3/4"	1"1/16 12h UNF	641401712	12,85
1"	1"5/16 12h UNF	641402116	21,15
1"1/4	1"5/8 12h UNF	641402620	31,98
1"1/2	1"7/8 12h UNF	641403024	38,94
2"	2"1/2 12h UNF	641404032	73,84

Por razones logísticas y de producción, estos productos se suministrarán según disponibilidad (Zn/Ni; CrIII). Las referencias más estándar (equivalentes a la serie B, ver págs. (56-58), se suministrarán habitualmente en Zn/Ni. / Pour des raisons logistiques et de fabrication, les produits (Zn/Ni; CrIII) seront fournis selon disponibilité. Les références standard, équivalentes à la série B, voir pages (56-58), seront fournies normalement en Zn/Ni. / For logistics and manufacturing reasons, products (Zn/Ni; CrIII) will be supplied upon availability, Standard references, equivalent to B series, see pages (56-58), will, usually, be supplied in Zn/Ni. / Per ragioni di logistica e di produzione, questi articoli saranno forniti secondo la disponibilità (Zn/Ni; CrIII) i codici più standard (equivalenti alla serie B, vedere pagine (56-58), saranno forniti abitualmente in Zn/Ni.

## Conexiones Interlock Zn/Ni

Embouts à sertir Interlock Zn/Ni  
Interlock serie fittings Zn/Ni  
Raccordi serie Interlock Zn/Ni

75

Hoses

Flexible hose fittings

Stainless steel hoses and fittings

Low pressure

Air conditioned hoses and fittings

Measuring flow

Machines for mounting flexibles

### Hembra giratoria recta Métrica cono 24° con junta tórica

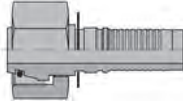

Femelle tournante Métrique 24° + o'ring  
Metric swivel female 24° seat with o'ring  
Femmina Metrica sede 24° con o'ring

DN	TUBO PIPE	SERIE	ROSCA THREAD	REFERENCIA PART N°	€
3/4"	20	S	M30X2	64204302012	18,35
3/4"	25	S	M36X2	64204362512	18,83
1"	30	S	M42X2	64204423016	20,77
1 1/4"	38	S	M52X2	64204523820	31,22

### Hembra giratoria 90° Métrica cono 24° con junta tórica

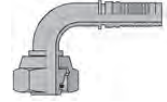

Femelle tournante coude 90° Métrique + o'ring  
90° Metric swivel female 24° seat with o'ring  
Femmina a 90° Metrica sede 24° con o'ring

DN	TUBO PIPE	SERIE	ROSCA THREAD	REFERENCIA PART N°	€
3/4"	20	S	M30X2	64205302012	29,76
3/4"	25	S	M36X2	64205362512	27,99
1"	30	S	M42X2	64205423016	36,27
1 1/4"	38	S	M52X2	64205523820	55,10

### Hembra giratoria 45° Métrica cono 24° con junta tórica



Femelle tournante coude 45° Métrique + o'ring  
45° Metric swivel female 24° seat with o'ring  
Femmina a 45° sede 24° con o'ring

DN	TUBO PIPE	SERIE	ROSCA THREAD	REFERENCIA PART N°	€
3/4"	20	S	M30X2	64206302012	35,70
3/4"	25	S	M36X2	64206362512	29,99
1"	30	S	M42X2	64206423016	38,86
1 1/4"	38	S	M52X2	64206523820	59,03

### Macho rosca Métrica cono 24° con junta tórica

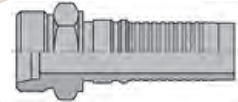

Mâle fixe Métrique 24° série lourde  
Metric male stud 24° cone  
Maschio Metrico sede 24°

DN	TUBO PIPE	SERIE	ROSCA THREAD	REFERENCIA PART N°	€
3/4"	20	S	M30X2	64203302012	16,75
3/4"	25	S	M36X2	64203362512	18,79
1"	30	S	M42X2	64203423016	24,60
1 1/4"	38	S	M52X2	64203523820	34,44

### Hembras rectas ORFS



Femelle droite ORFS  
ORFS Swivel female  
Femmina diritta ORFS Interlock

TUBO PIPE	ROSCA THREAD	REFERENCIA PART N°	€
3/4"	1" 3/16	649001212	16,59
1"	1" 7/16	649001616	31,98
1" 1/4"	1" 11/16	649002020	37,88
1" 1/2"	2"	649002424	60,37

### Codos 90° ORFS

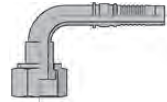

Coude 90° femelle ORFS  
90° ORFS Swivel female  
Curva a 90° ORFS Interlock

TUBO PIPE	ROSCA THREAD	REFERENCIA PART N°	€
3/4"	1" 3/16	649071212	27,14
1"	1" 7/16	649071616	39,36
1" 1/4"	1" 11/16	649072020	52,15
1" 1/2"	2"	649072424	77,83

### Codos 45° ORFS



Coude 45° femelle ORFS  
45° ORFS Swivel female  
Curva a 45° ORFS Interlock

TUBO PIPE	ROSCA THREAD	REFERENCIA PART N°	€
3/4"	1" 3/16	649081212	27,14
1"	1" 7/16	649081616	39,36
1" 1/4"	1" 11/16	649082020	52,15
1" 1/2"	2"	649082424	77,83

Por razones logísticas y de producción, estos productos se suministrarán según disponibilidad (Zn/Ni; CrIII). Las referencias más estándar (equivalentes a la serie B, ver págs. (56-58), se suministrarán habitualmente en Zn/Ni. / Pour des raisons logistiques et de fabrication, les produits (Zn/Ni; CrIII) seront fournis selon disponibilité. Les références standard, équivalentes à la série B, voir pages (56-58), seront fournies normalement en Zn/Ni. / For logistics and manufacturing reasons, products (Zn/Ni; CrIII) will be supplied upon availability. Standard references, equivalent to B series, see pages (56-58), will, usually, be supplied in Zn/Ni. / Per ragioni di logistica e di produzione, questi articoli saranno forniti secondo la disponibilità (Zn/Ni; CrIII) i codici più standard (equivalenti alla serie B, vedere pagine (56-58), saranno forniti abitualmente in Zn/Ni.

## Conexiones Interlock Zn/Ni

Embouts à sertir Interlock Zn/Ni  
Interlock serie fittings Zn/Ni  
Raccordi serie Interlock Zn/Ni

Hoses

### Brida SAE 3000 PSI



Bride SAE droite série 3000 PSI  
3000 PSI SAE Straight flange  
Flangia SAE 3000 PSI

DN	Ø	REFERENCIA PART N°	€
3/4"	38.1	641821212	18,04
3/4"	44.5	641821612	26,07
1"	44.5	641821616	24,60
1"	50.8	641822016	33,95
1 1/4"	50.8	641822020	34,93
1 1/4"	60.3	641822420	45,75
1 1/2"	60.3	641822424	48,70
1 1/2"	71.4	641823224	78,71
2"	71.4	641823232	71,33

### Brida SAE 6000 PSI

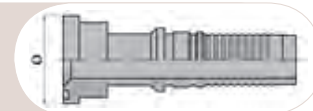

Bride SAE droite série 6000 PSI  
6000 PSI SAE Straight flange  
Flangia SAE 6000 PSI

DN	Ø	REFERENCIA PART N°	€
3/4"	41.3	642821212	17,97
3/4"	47.6	642821612	25,25
1"	47.6	642821616	27,09
1"	54	642822016	33,52
1 1/4"	54	642822020	33,69
1 1/4"	63.5	642822420	51,43
1 1/2"	63.5	642822424	48,29
1 1/2"	79.4	642823224	92,98
2"	79.4	642823232	98,39

Flexible hose fittings

Stainless steel hoses  
and fittings

Low pressure

Air conditioned hoses  
and fittings

Measuring flow

Machines for  
mounting flexibles

### Brida a 90° SAE 3000 PSI

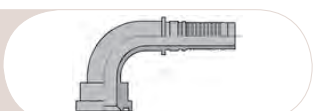

Bride SAE coude 90° série 3000 PSI  
90° 3000 PSI SAE Flange  
Flangia a 90° SAE 3000 PSI

DN	Ø	REFERENCIA PART N°	€
3/4"	38.1	641831212	26,57
3/4"	44.5	641831612	35,18
1"	44.5	641831616	35,18
1"	50.8	641832016	44,77
1 1/4"	50.8	641832020	53,13
1 1/4"	60.3	641832420	73,79
1 1/2"	60.3	641832424	83,63
1 1/2"	71.4	641833224	127,91
2"	71.4	641833232	152,51

### Brida a 90° SAE 6000 PSI

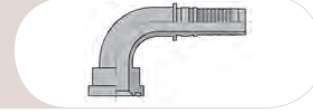

Bride SAE coude 90° série 6000 PSI  
90° 6000 PSI SAE Flange  
Flangia a 90° SAE 6000 PSI

DN	Ø	REFERENCIA PART N°	€
3/4"	41.3	642831212	24,70
3/4"	47.6	642831612	34,44
1"	47.6	642831616	35,82
1"	54	642832016	51,66
1 1/4"	54	642832020	50,79
1 1/4"	63.5	642832420	80,19
1 1/2"	63.5	642832424	86,09
1 1/2"	79.4	642833224	155,46
2"	79.4	642833232	184,31

### Brida a 45° SAE 3000 PSI

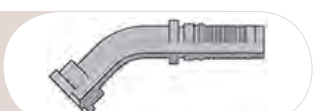

Bride SAE coude 45° série 3000 PSI  
45° 3000 PSI SAE Flange  
Flangia a 45° SAE 3000 PSI

DN	Ø	REFERENCIA PART N°	€
3/4"	38.1	641841212	26,57
3/4"	44.5	641841612	35,18
1"	44.5	641841616	35,18
1 1/4"	50.8	641842020	53,13
1 1/4"	60.3	641842420	73,79
1 1/2"	60.3	641842424	83,63
1 1/2"	71.4	641843224	127,91
2"	71.4	641843232	152,51

### Brida a 45° SAE 6000 PSI



Bride SAE coude 45° série 6000 PSI  
45° 6000 PSI SAE Flange  
Flangia a 45° SAE 6000 PSI

DN	Ø	REFERENCIA PART N°	€
3/4"	41.3	642841212	27,55
3/4"	47.6	642841612	36,89
1"	47.6	642841616	38,37
1"	54	642842016	51,66
1 1/4"	54	642842020	57,07
1 1/4"	63.5	642842420	76,74
1 1/2"	63.5	642842424	86,09
1 1/2"	79.4	642843224	156,44
2"	79.4	642843232	162,35

Por razones logísticas y de producción, estos productos se suministrarán según disponibilidad (Zn/Ni; CrIII). Las referencias más estándar (equivalentes a la serie B, ver págs. (56-58), se suministrarán habitualmente en Zn/Ni. / Pour des raisons logistiques et de fabrication, les produits (Zn/Ni; CrIII) seront fournis selon disponibilité. Les références standard, équivalentes à la série B, voir pages (56-58), seront fournies normalement en Zn/Ni. / For logistics and manufacturing reasons, products (Zn/Ni; CrIII) will be supplied upon availability. Standard references, equivalent to B series, see pages (56-58), will, usually, be supplied in Zn/Ni. / Per ragioni di logistica e di produzione, questi articoli saranno forniti secondo la disponibilità (Zn/Ni; CrIII) i codici più standard (equivalenti alla serie B, vedere pagine (56-58), saranno forniti abitualmente in Zn/Ni.

## Conexiones Interlock Zn/Ni

Embouts à sertir Interlock Zn/Ni  
Interlock serie fittings Zn/Ni  
Raccordi serie Interlock Zn/Ni

### Brida Caterpillar 9000 PSI

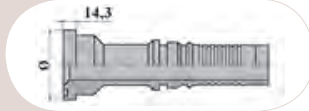

Bride droite Caterpillar série 9000 PSI  
9000 PSI Caterpillar Straight flange  
Flangia Caterpillar 9000 PSI

DN	Ø	REFERENCIA PART N°	€
3/4"	41.3	643821212	24,03
1"	47.6	643821616	31,94
1"	54	643822016	42,64
1"1/4	54	643822020	42,49
1"1/4	63.5	643822420	59,06
1"1/2	63.5	643822424	61,44

### Brida a 90° Caterpillar 9000 PSI

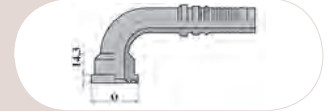

Bride coude 90° Caterpillar série 9000 PSI  
90° 9000 PSI Caterpillar Flange  
Flangia a 90° Caterpillar 9000 PSI

DN	Ø	REFERENCIA PART N°	€
3/4"	41.3	643831212	34,14
3/4"	47.6	643831612	43,51
1"	47.6	643831616	48,00
1"	54	643832016	60,20
1"1/4	54	643832020	65,02
1"1/4	63.5	643832420	98,27
1"1/2	63.5	643832424	94,90

### Brida a 45° Caterpillar 9000 PSI

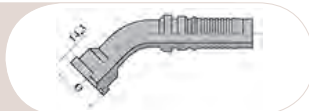

Bride coude 45° Caterpillar série 9000 PSI  
45° 9000 PSI Caterpillar Flange  
Flangia a 45° Caterpillar 9000 PSI

DN	Ø	REFERENCIA PART N°	€
3/4"	41.3	643841212	33,77
3/4"	47.6	643841612	43,51
1"	47.6	643841616	48,00
1"	54	643842016	60,20
1"1/4	54	643842020	65,02
1"1/4	63.5	643842420	98,27
1"1/2	63.5	643842424	94,90

Hoses

Flexible hose fittings

Stainless steel hoses  
and fittings

Low pressure

Air conditioned hoses  
and fittings

Measuring flow

Machines for  
mounting flexibles

Por razones logísticas y de producción, estos productos se suministrarán según disponibilidad (Zn/Ni; CrIII). Las referencias más estándar (equivalentes a la serie B, ver págs. (56-58), se suministrarán habitualmente en Zn/Ni. / Pour des raisons logistiques et de fabrication, les produits (Zn/Ni; CrIII) seront fournis selon disponibilité. Les références standard, équivalentes à la série B, voir pages (56-58), seront fournies normalement en Zn/Ni. / For logistics and manufacturing reasons, products (Zn/Ni; CrIII) will be supplied upon availability, Standard references, equivalent to B series, see pages (56-58), will, usually, be supplied in Zn/Ni. / Per ragioni di logistica e di produzione, questi articoli saranno forniti secondo la disponibilità (Zn/Ni; CrIII) i codici più standard (equivalenti alla serie B, vedere pagine (56-58), saranno forniti abitualmente in Zn/Ni.

# Tabla de prensados para mangueras hidráulicas

Tableau sertissage pour les tuyaux hydrauliques | Crimping table for hydraulic hoses |  
Tabella di pressatura per tubi idraulici

Tolerancias de prensado | Tolerance de sertissage | Crimping tolerances | Toleranza di pressatura  
1/8" - 3/8" : + 0 / - 0,2 | 1/2" - 2" 1/2 : + 0 / - 0,4

Manguera   Tuyaux Hose   Tubo	DN (mm) Pulgadas   Pouces   Inches   Inch Gauga   Piges   Gauge   size	5	6	8	10	12	16	19	25	31	38	51
EN 857 1SC MS1SC	Casquillo   Jupe   Ferrule   Boccola	-	PF23	PF23	PF23	PF23	-	-	-	-	-	-
	Ø Ext. casquillo   Jupe   Ferrule   Boccola	-	DI23	DI23	DI23	DI23	-	-	-	-	-	-
	Ø Ext. manguera   Tuyaux   Hose   Tubo Ø Prensado   Sertissage   Crimping   Pressatura	-	13	14	16,5	19,5	-	-	-	-	-	-
EN 857 2SC MS2SC	Casquillo   Jupe   Ferrule   Boccola	-	PF2212	PF2212	PF2212	PF2212	-	-	-	-	-	-
	Ø Ext. casquillo   Jupe   Ferrule   Boccola	-	DI2212	DI2212	DI2212	DI2212	-	-	-	-	-	-
	Ø Ext. manguera   Tuyaux   Hose   Tubo Ø Prensado   Sertissage   Crimping   Pressatura	-	23	24	26	29	-	-	-	-	-	-
SAE 100 R1AT EN 853 1SN MS2230 / ML2230	Casquillo   Jupe   Ferrule   Boccola	PF2212	PF2212	PF2212	PF2212	PF2212	PF2212	PF2212	PF2212	PF2212	PF2212	PF2212
	Ø Ext. casquillo   Jupe/Ferrule   Boccola	DI2212	DI2212	DI2212	DI2212	DI2212	DI2212	DI2212	DI2212	DI2212	DI2212	DI2212
	Ø Ext. manguera   Tuyaux   Hose   Tubo	21	23	24	26	29	33	37	46	59	67	80
	Ø Prensado   Sertissage   Crimping   Pressatura	11,5	13,5	15,4	17,5	20,3	23,9	28,2	36	44	50,3	64
	Pelado ext.   Denudage ext.   Outside Skive   Pelatura esterna	15,7	18,1	19,2	20,8	23,1	27,5	31,5	39,5	48,8	57	70
SAE 100 R2AT EN 853 2SN ML3511 / MS3511	Casquillo   Jupe   Ferrule   Boccola	PF2212	PF2212	PF2212	PF2212	PF2212	PF2212	PF2212	PF2212	PF2212	PF2212	PF2212
	Ø Ext. casquillo   Jupe   Ferrule   Boccola	DI2212	DI2212	DI2212	DI2212	DI2212	DI2212	DI2212	DI2212	DI2212	DI2212	DI2212
	Ø Ext. manguera   Tuyaux   Hose   Tubo	21	23	24	26	29	33	37	46	59	67	80
	Ø Prensado   Sertissage   Crimping   Pressatura	13,2	14,8	16,6	18,9	22	25,3	29	37	47,5	54,3	66,7
	Pelado ext.   Denudage ext.   Outside Skive   Pelatura esterna	16,2	18,8	19,8	22	24,2	28,7	32,6	40,5	51,8	60	72,5
SAE 100 R1A EN 853 1ST ML2231	Casquillo   Jupe   Ferrule   Boccola	22003	22003	22003	22003	22003	22003	22003	22003	22003	22003	22003
	Ø Ext. casquillo   Jupe   Ferrule   Boccola	18	20	21	24	28	31	35	42	52	58	71
	Ø Prensado   Sertissage   Crimping   Pressatura	15,5	17,8	18,8	21,7	25,2	28,8	32,5	38,8	49	55	66
	Pelado ext.   Denudage ext.   Outside Skive   Pelatura esterna	22,5	22,5	22,5	22,5	26	27	31	39	45	50	58
SAE 100 R2A EN 853 2ST ML3509 / MS3509	Casquillo   Jupe   Ferrule   Boccola	PF1224	PF1224	PF1224	PF1224	PF1224	PF1224	PF1224	PF1224	PF1224	PF1224	PF1224
	Ø Ext. casquillo   Jupe   Ferrule   Boccola	DH1224	DH1224	DH1224	DH1224	DH1224	DH1224	DH1224	DH1224	DH1224	DH1224	DH1224
	Ø Ext. manguera   Tuyaux   Hose   Tubo	21	22	23	26	30	33	38	46	57	65	79
	Ø Prensado   Sertissage   Crimping   Pressatura	18,2	17,6	20	22,5	26,3	29,1	33,8	42,2	51	59	72,3
SAE 100 R9R-R10 EN 856 4SP MS4290 / MS4248 ML4290 / ML4248	Casquillo   Jupe   Ferrule   Boccola	-	PF1224	-	PF1224	PF1224	PF1224	PF1224	PF1224	PF1224	PF1224	PF1224
	Ø Ext. casquillo   Jupe   Ferrule   Boccola	-	DH1224	-	DH1224	DH1224	DH1224	DH1224	DH1224	DH1224	DH1224	DH1224
	Ø Prensado   Sertissage   Crimping   Pressatura	-	22	-	26	30	33	38	46	57	65	79
	Pelado ext.   Denudage ext.   Outside Skive   Pelatura esterna	-	18,8	-	23,4	26,5	29,7	34,4	42,2	51,7	59,7	73
SAE 100 R12 EN 856 R12 M4612	Casquillo   Jupe   Ferrule   Boccola	-	-	-	-	PF1224	PF1224	PF1224	PF1224	PF1224	PF1224	
	Ø Ext. casquillo   Jupe   Ferrule   Boccola	-	-	-	-	DI1224	DI1224	DI1224	DI1224	DI1224	DI1224	
	Ø prensado   Sertissage   Crimping   Pressatura	-	-	-	-	30	33	38	46	57	65	
	Pelado ext.   Denudage ext.   Outside Skive   Pelatura esterna	-	-	-	-	26,7	29,3	34,4	42,2	50,5	59,7	
Limpieza alcantarillas Tuyau hydrocurage Sewer jetting hose Tubi per la pulizia di fognature ML2250	Casquillo   Jupe   Ferrule   Boccola							Z21200	Z21200			
	Ø Ext. casquillo   Jupe   Ferrule   Boccola							42	49			
	Ø Ext. manguera   Tuyaux   Hose   Tubo							31,5	39,8			
	Ø Ext. manguera   Tuyaux   Hose   Tubo							37,2	45			

NOTA: Las tablas de prensado DICSА son siempre orientativas | Les tableaux de sertissage DICSА sont toujours à titre indicatif | DICSА's crimping tables are intended as a guide | Le tabella di pressatura DICSА sono sempre orientative.

Los diámetros de prensado han sido validados para estos diámetros exteriores de manguera. Por lo tanto, éstos diámetros pueden variar dependiendo de la manguera | Les diámetros de sertissage ont été vérifiés pour les diámetros de tuyau indiqués. Par conséquent, les diámetros de sertissage peuvent être différents pour d'autres types de tuyau | Crimping diameters have been validated for these outer diameters of the hoses. Therefore, these diameters can change depending on the hose | I diámetro di pressatura sono stati testati per questi diámetro esterni di tubo. Saranno quindi passibili di variazione con il variare Della natura dei tubi.

## Tabla de prensados para mangueras hidráulicas

Tableau sertissage pour les tuyaux hydrauliques | Crimping table for hydraulic hoses |  
Tabella di pressatura per tubi idraulici

Tolerancias de prensado | Tolerance de sertissage | Crimping tolerances | Toleranza di pressatura  
1/8" - 3/8" : + 0 / - 0,2 | 1/2" - 2" 1/2 : + 0 / - 0,4

Manguera   Tuyaux Hose   Tubo	DN (mm)	5	6	8	10	12	16	19	25	31	38	51
	Pulgadas   Pouces   Inches   Inch	3/16"	1/4"	5/16"	3/8"	1/2"	5/8"	3/4"	1"	1 1/4"	1 1/2"	2"
	Galga   Piges   Gauge   size	03	04	05	06	08	10	12	16	20	24	32
EN 856 4SH	Casquillo   Jupe   Ferrule   Boccia	-	-	-	-	-	-	A61010	A61010	A61010	A61010	A61010
	Ø Ext. casquillo   Jupe   Ferrule   Boccia							40	47	56	63	80
Conex. interlock	Ø Prensado   Sertissage   Crimping   Pressatura							<b>35,5</b>	<b>42</b>	<b>50</b>	<b>57</b>	<b>74</b>
ML4569 / MS4569	Pelado int.   Denudage int.   Inn. Skive   Pelatura interna							17	18	21	24	26
	Pelado ext.   Denudage ext.   Outside Skive   Pelatura esterna							52	57	64	77	82
SAE 100 R13	Casquillo   Jupe   Ferrule   Boccia	-	-	-	-	-	-	A61010	A61010	61010	61010	61010
	Ø Ext. casquillo   Jupe   Ferrule   Boccia							40	47	61	70	85
EN 856 R13	Ø Ext. manguera   Tuyaux   Hose   Tubo							32,1	38,3	49,7	57,2	70,8
Conex. interlock	Ø Prensado   Sertissage   Crimping   Pressatura							<b>36</b>	<b>42,5</b>	<b>55</b>	<b>64</b>	<b>79</b>
M4713	Pelado int.   Denudage int.   Inn. Skive   Pelatura interna							17	18	21	24	26
	Pelado ext.   Denudage ext.   Outside Skive   Pelatura esterna							52	57	64	77	82
SAE 100 R15	Casquillo   Jupe   Ferrule   Boccia	-	-	-	-	-	-	A61010	A61010	61010	61010	-
	Ø Ext. casquillo   Jupe   Ferrule   Boccia							40	47	61	70	
EN856	Ø Prensado   Sertissage   Crimping   Pressatura							<b>35,5</b>	<b>42</b>	<b>54,5</b>	<b>64</b>	
Conex. interlock	Pelado int.   Denudage int.   Inn. Skive   Pelatura interna							17	18	21	24	
	Pelado ext.   Denudage ext.   Outside Skive   Pelatura esterna							52	57	64	77	
M4815												

NOTA: Las tablas de prensado DICSA son siempre orientativas | Les tableaux de sertissage DICSA sont toujours à titre indicatif | DICSA's crimping tables are intended as a guide | Le tabbelle di pressatura DICSA sono sempre orientative.

Los diámetros de prensado han sido validados para estos diámetros exteriores de manguera. Por lo tanto, éstos diámetros pueden variar dependiendo de la manguera | Les diámetros de sertissage ont été vérifiés pour les diámetros de tuyau indiqués. Par conséquent, les diámetros de sertissage peuvent être différents pour d'autres types de tuyau | Crimping diameters have been validated for these outer diameters of the hoses. Therefore, these diameters can change depending on the hose | I diametri di pressatura sono stati testati per questi diametri esterni di tubo. Saranno quindi passibili di variazione con il variare Della natura dei tubi.





Gama de productos. Para más información soliciten nuestros catálogos generales o visiten nuestra página web  
Gamme de produits. Pour plus d'information, nous vous prions de nous demander nos catalogues generaux ou visiter notre web-site  
Products range. For any further information, please, ask for our general catalogues or visit our web-site  
Gamma di Prodotti. Per ulteriori información di ricuidete il nostri cataloghi o visitate la Nostra pagina web

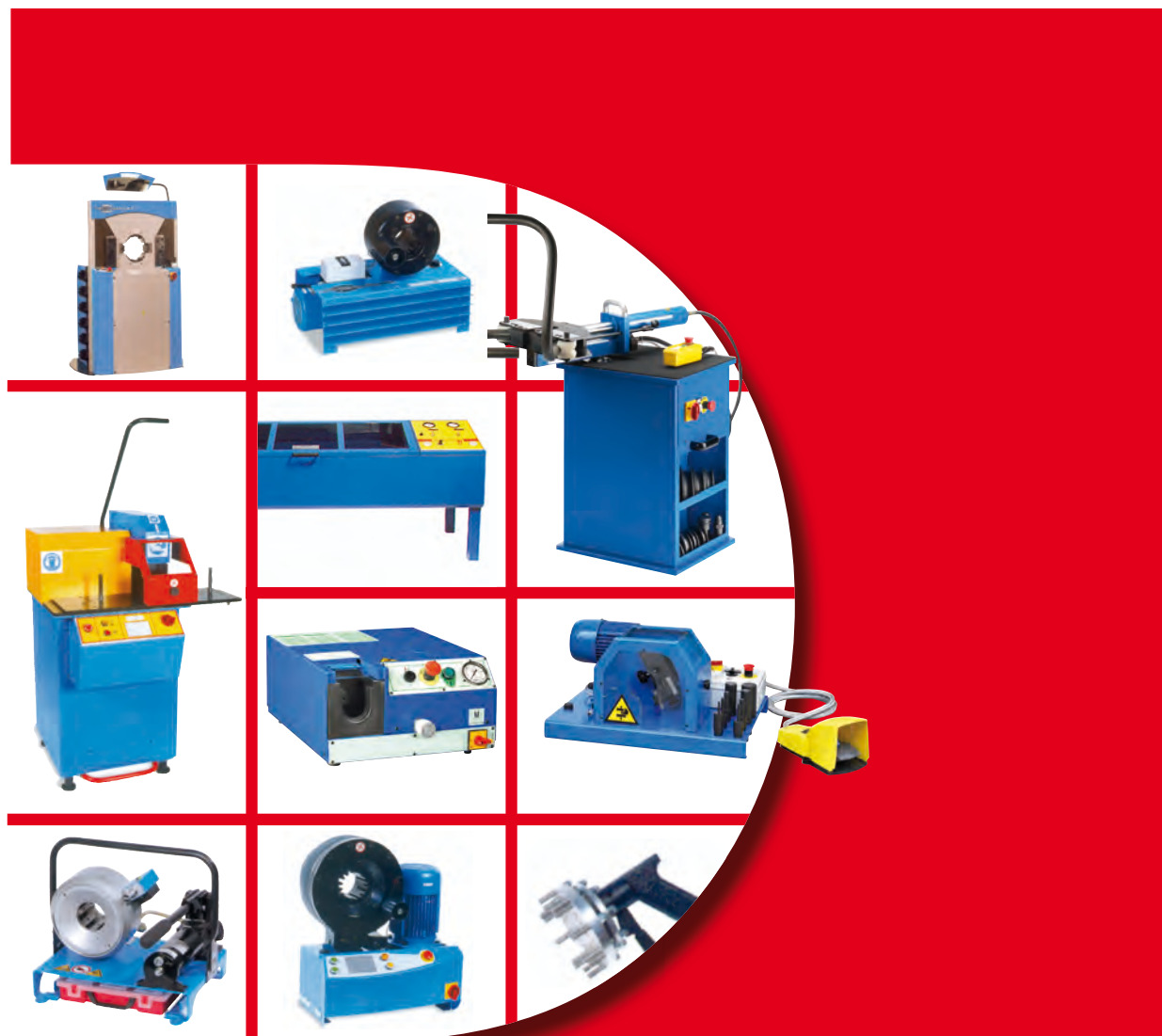

# DICSA

Máquinas para el montaje de latiguillos y tubo rígido  
Machines for mounting flexible and pipe  
Machines pour le montage des flexibles et tubes rigides

[www.dicsaes.com](http://www.dicsaes.com)

# Manguera Inox, Racores y Bridas soldables

Tuyau Inox, raccords et brides à souder

Stainless steel hose, welding fittings and forged flanges

Tubi Inox, raccordi e flange a saldare

# 3

Manguera Inox, Racores y Bidas soldables

Tuyau Inox, raccords et brides à souder | Stainless steel hose, welding fittings and forged flanges  
| Tubi Inox, raccordi e flange a saldare

84

## Manguera Inox, Racores y Bridas soldables

Tuyau Inox, raccords et brides à souder | Stainless steel hose, welding fittings and forged flanges | Tubi Inox, raccordi e flange a saldare

Hoses

Flexible hose fittings

Stainless steel hoses and fittings

Low pressure

Air conditioned hoses and fittings

Measuring flow

Machines for mounting flexibles

### ▶ Mangueras Inox coarrugado | Tuyaux inox onduleux | Convoluted stainless steel hoses | Tubi Inox corrugato

85



M93211



M93212



M93161



M304

### ▶ Racores soldables BSP | Raccords à souder BSP | BSP Welding fittings | Raccordi a saldare BSP

86

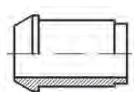

A1278

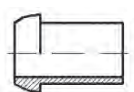

A1273

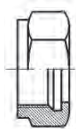

A1270

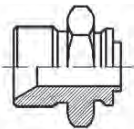

A1035

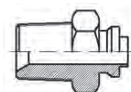

A1032

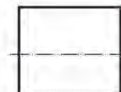

81070

### ▶ Bridas fijas para soldar | Brides DIN à souder fixes | Fixed Forged flanges | Flangia a saldare

87



BPN162633



BANSAWN150

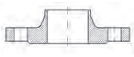

BPN402635



BANSAWN300

### ▶ Conjunto brida DIN 2642 | Ensemble brides tournantes DIN 2642 | DIN 2642 swivel flanges set | Flangia girevole DIN 2642

88

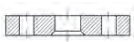

BPN102642

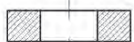

ABARO2642



ABTUB

### ▶ Conjunto brida DIN 2656 | Ensemble brides tournantes DIN 2656 | DIN 2656 swivel flanges set | Flangia girevole DIN 2656

89

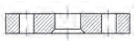

BPN402656

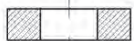

ABARO2656



ABTUB

### ▶ Conjunto brida ANSI-ASA | Ensemble brides ANSI-ASA | ANSI-ASA swivel flanges set | Flangia girevole ANSI-ASA

90



BANSASO150



BANSASO300

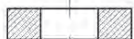

ABAROANSA



ABTUB

## Manguera Inox, Racores y Bridas soldables

Tuyau Inox, raccords et brides à souder  
Stainless steel hose, welding fittings and forged flanges  
Tubi Inox, raccordi e flange a saldare

### Inox coarrugado AISI 321 con una malla AISI 304



Inox onduleux AISI 321 avec une tresse inox AISI 304

Convoluted S.S. AISI 321 hose with one braid S.S. AISI 304

Tubo in Inox corrugato 321 con una maglia AISI 304

DN	TUBO PIPE	REFERENCIA PART N°	€
6	1/4"	M93211006	8,43
10	3/8"	M93211010	9,27
12	1/2"	M93211012	10,12
16	5/8"	M93211016	16,02
20	3/4"	M93211020	20,23
25	1"	M93211025	26,13
32	1" 1/4	M93211032	30,35
40	1" 1/2	M93211040	39,20
50	2"	M93211050	55,22
65	2" 1/2	M93211065	77,56
80	3"	M93211080	89,78
100	4"	M93211100	116,33

### Inox coarrugado AISI 321 con dos mallas AISI 304



Inox onduleux AISI 321 avec deux tresses inox AISI 304

Convoluted S.S. AISI 321 hose with two braids S.S. AISI 304

Tubo in Inox corrugato 321 con due maglie AISI 304

DN	TUBO PIPE	REFERENCIA PART N°	€
6	1/4"	M93212006	10,96
10	3/8"	M93212010	12,65
12	1/2"	M93212012	13,91
20	3/4"	M93212020	28,66
25	1"	M93212025	36,25
32	1" 1/4	M93212032	42,99
40	1" 1/2	M93212040	56,90
50	2"	M93212050	80,51
65	2" 1/2	M93212065	109,17
80	3"	M93212080	125,61
100	4"	M93212100	163,54

### Inox coarrugado AISI 316 con una malla AISI 316



Inox onduleux AISI 316 avec une tresse inox AISI 316

Convoluted S.S. AISI 316 hose with one braid S.S. AISI 316

Tubo in Inox corrugato 316 con una maglia AISI 316

DN	TUBO PIPE	REFERENCIA PART N°	€
6	1/4"	M93161006	11,38
10	3/8"	M93161010	13,49
12	1/2"	M93161012	16,02
20	3/4"	M93161020	30,35
25	1"	M93161025	35,83
32	1" 1/4	M93161032	54,80
40	1" 1/2	M93161040	63,23
50	2"	M93161050	84,30
65	2" 1/2	M93161065	113,80
80	3"	M93161080	132,35
100	4"	M93161100	174,08

### Malla inox 304

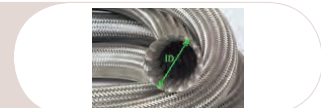

Tresse inox 304

AISI 304 braid

Maglia di acciaio Inox 304

Ø in	REFERENCIA PART N°	€
9.6 mm	M304009.6	3,45
12.3 mm	M304012.3	3,83
14.3 mm	M304014.3	4,22
16.7 mm	M304016.7	4,60
21.6 mm	M304021.6	8,81
26.8 mm	M304026.8	9,96
32.2 mm	M304032.2	11,88
41.1 mm	M304041.1	17,63
49.8 mm	M304049.8	21,46
80.8 mm	M304080.8	39,08
60.3 mm	M304060.3	27,59

## Manguera Inox, Racores y Bridas soldables

Tuyau Inox, raccords et brides à souder  
Stainless steel hose, welding fittings and forged flanges  
Tubi Inox, raccordi e flange a saldare

Hoses

Flexible hose fittings

Stainless steel hoses and fittings

Low pressure

Air conditioned hoses and fittings

Measuring flow

Machines for mounting flexibles

### Cono ajuste 60° con guía

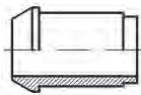

Collet cône 60° à souder (bw) + guide  
Welding nipple 60° cone for BSP nut with guide  
Ogiva a saldare sede 60° per dado BSP con guida

DN	ROSCA THREAD	REFERENCIA PART N°	€
1/4"	1/4" BSP	A127804	0,58
3/8"	3/8" BSP	A127806	0,58
1/2"	1/2" BSP	A127808	1,22
3/4"	3/4" BSP	A127812	1,79
1"	1" BSP	A127816	2,14
1" 1/4	1"1/4 BSP	A127820	4,86
1"1/2	1"1/2 BSP	A127824	6,82
2"	2" BSP	A127832	11,75
2"1/2	2"1/2 BSP	A127840 **	31,35

\*\* Hasta fin de existencias // Jusqu'à la fin du stock // Until end of stock // Fino ad esaurimento scorta

### Macho BSP cono 60° con guía

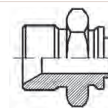

Mamelon hexagonal gaz cyl BSP à souder (bw) + guide  
Welding adaptor BSP 60°  
Maschio BSP a saldare sede 60° con guida

DN	ROSCA THREAD	REFERENCIA PART N°	€
1/4"	1/4" BSP	A103504	0,99
3/8"	3/8" BSP	A103506	1,15
1/2"	1/2" BSP	A103508	1,64
3/4"	3/4" BSP	A103512	2,72
1"	1" BSP	A103516	3,94
1"1/4	1"1/4 BSP	A103520	9,04
1"1/2	1"1/2 BSP	A103524	12,65
2"	2" BSP	A103532	26,37

### Macho cónico BSPT con guía

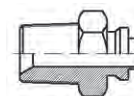

Mamelon hexagonal gaz conique à souder (bw) + guide  
Welding adaptor BSPT  
Maschio conico BSPT con guida

DN	ROSCA THREAD	REFERENCIA PART N°	€
1/4"	1/4" BSPT	A103204	1,89
3/8"	3/8" BSPT	A103206	2,14
1/2"	1/2" BSPT	A103208	2,88
3/4"	3/4" BSPT	A103212	3,41
1"	1" BSPT	A103216	5,34
1"1/4	1"1/4 BSPT	A103220	13,56
1"1/2	1"1/2 BSPT	A103224	13,39
2"	2" BSPT	A103232	18,65
2"1/2	2"1/2 BSPT	A103240	56,20

### Cono ajuste sin guía

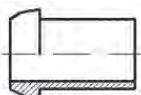

Collet à souder sans guide  
Welding nipple without guide  
Ogiva a saldare BSP

DN	ROSCA THREAD	REFERENCIA PART N°	€
1/4"	1/4" BSP	A127304	0,49
3/8"	3/8" BSP	A127306	0,49
1/2"	1/2" BSP	A127308	0,90
3/4"	3/4" BSP	A127312	1,07
1"	1" BSP	A127316	1,89
1"1/4	1"1/4 BSP	A127320	2,71
1"1/2	1"1/2 BSP	A127324	4,77
2"	2" BSP	A127332	6,74

### Tuerca cono ajuste rosca BSP



Écrou gaz pour collet à souder bw (60°)  
BSP nut for welding nipple 60° cone  
Dado BSP per ogiva a saldare

ROSCA THREAD	REFERENCIA PART N°	€
1/4" BSP	A127004	0,79
3/8" BSP	A127006	0,74
1/2" BSP	A127008	0,94
3/4" BSP	A127012	1,07
1" BSP	A127016	2,38
1"1/4 BSP	A127020	4,93
1"1/2 BSP	A127024	6,57
2" BSP	A127032	10,19
2"1/2 BSP	A127040 **	18,78

\*\* Hasta fin de existencias // Jusqu'à la fin du stock // Until end of stock // Fino ad esaurimento scorta

### Casquillo soldable Inox coarugado

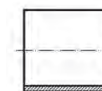

Jupe à souder Inox convoluté  
Convuluted SS welding ferrule  
Boccola a saldare per inox corrugato

DN	Ø in	REFERENCIA PART N°	€
1/4"	14	810700400	*
3/8"	19	810700600	*
1/2"	22	810700800	*
5/8"	25	810701000	*
3/4"	30	810701200	*
1"	38	810701600	*
1"1/4	47.8	810702000	*
1"1/2	56.1	810702400	*
2"	70	810703200	*
2"1/2	84.8	810704000	*
3"	108.2	810704800	*
4"	125	810706400	*

Acero inoxidable AISI 316-L / Acier inoxydable AISI 316-L / Stainless steel AISI 316-L / Acciao inossidabile AISI 316-L

## Manguera Inox, Racores y Bridas soldables

Tuyau Inox, raccords et brides à souder  
Stainless steel hose, welding fittings and forged flanges  
Tubi Inox, raccordi e flange a saldare

### Brida fija DIN 2633 PN 10/16

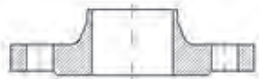

Bride fixe avec collerette DIN 2633 PN 10/16 à souder  
Fixed forged flange DIN 2633 PN 10/16  
Flangia fissa a saldare DIN 2633 PN 10/16

DN	REFERENCIA PART N°	€
3/8"	BPN16263306	8,52
1/2"	BPN16263308	11,82
3/4"	BPN16263312	18,53
1"	BPN16263316	19,80
1" 1/4	BPN16263320	20,26
1" 1/2	BPN16263324	22,50
2"	BPN16263332	30,36
2" 1/2	BPN16263340	36,77
3"	BPN16263348	44,42
4"	BPN16263364	55,88

### Brida fija DIN 2635 PN 40

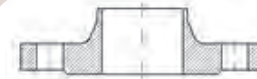

Bride fixe avec collerette DIN 2635 PN 40 à souder  
Fixed forged flange DIN 2635 PN 40  
Flangia fissa a saldare DIN 2635 PN 40

DN	REFERENCIA PART N°	€
3/8"	BPN40263506	8,94
1/2"	BPN40263508	12,41
3/4"	BPN40263512	19,45
1"	BPN40263516	20,79
1" 1/4	BPN40263520	21,27
1" 1/2	BPN40263524	23,62
2"	BPN40263532	31,87
2" 1/2	BPN40263540	38,61
3"	BPN40263548	46,63
4"	BPN40263564	58,67

### Brida ANSI-ASA Neck 150 LBS



Bride ANSI-ASA w. Neck 150 LBS  
Flange ANSI-ASA w. Neck 150 LBS  
Flangia ANSI-ASA 150 LBS

DN	REFERENCIA PART N°	€
1/2"	BANSAWN15008	13,00
3/4"	BANSAWN15012	20,38
1"	BANSAWN15016	21,78
1" 1/4	BANSAWN15020	22,28
1" 1/2	BANSAWN15024	24,75
2"	BANSAWN15032	31,87
2" 1/2	BANSAWN15040	40,45
3"	BANSAWN15048	48,85
4"	BANSAWN15064	61,47

### Brida ANSI-ASA Neck 300 LBS



Bride ANSI-ASA w. Neck 300 LBS  
Flange ANSI-ASA w. Neck 300 LBS  
Flangia ANSI-ASA Neck 300 LBS

DN	REFERENCIA PART N°	€
1/2"	BANSAWN30008	12,64
3/4"	BANSAWN30012	19,83
1"	BANSAWN30016	21,18
1" 1/4	BANSAWN30020	21,62
1" 1/2	BANSAWN30024	24,06
2"	BANSAWN30032	32,47
2" 1/2	BANSAWN30040	39,34
3"	BANSAWN30048	47,52
4"	BANSAWN30064	59,80



## Manguera Inox, Racores y Bidas soldables

Tuyau Inox, raccords et brides à souder  
Stainless steel hose, welding fittings and forged flanges  
Tubi Inox, raccordi e flange a saldare

Hoses

Flexible hose fittings

Stainless steel hoses  
and fittings

Low pressure

Air conditioned hoses  
and fittings

Measuring flow

Machines for  
mounting flexibles

### Brida loca DIN 2642 PN 10/16

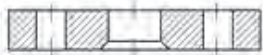

Bride plate tournante DIN 2642 PN 10/16 à souder  
Swivel forged flange DIN 2642 PN 10/16  
Flangia girevole a saldare DIN 2642 PN 10/16

DN	REFERENCIA PART N°	€
1/2"	BPN10264208	7,14
3/4"	BPN10264212	8,36
1"	BPN10264216	11,83
1" 1/4	BPN10264220	17,02
1" 1/2	BPN10264224	19,32
2"	BPN10264232	22,86
2" 1/2	BPN10264240	27,26
3"	BPN10264248	34,54
4"	BPN10264264	43,20

### Tubo soldar brida ANSI-DIN



Tube à souder brides ANSI-DIN  
Tube for welding flanges ANSI-DIN  
Tubo per flangia a saldare ANSI-DIN

DN	REFERENCIA PART N°	€
3/8"	ABTUB006	1,74
1/2"	ABTUB008	1,83
3/4"	ABTUB012	2,31
1"	ABTUB016	3,07
1" 1/4	ABTUB020	3,76
1" 1/2	ABTUB024	4,62
2"	ABTUB032	6,14
2" 1/2	ABTUB040	6,51
3"	ABTUB048	7,88
4"	ABTUB064	12,00

### Aro para brida DIN 2642

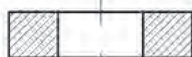

Collet épais pour bride DIN 2642  
Ring for flange DIN 2642  
Anello per flangia DIN 2642

DN	REFERENCIA PART N°	€
3/8"	ABARO264206	3,99
1/2"	ABARO264208	5,20
3/4"	ABARO264212	5,93
1"	ABARO264216	7,62
1" 1/4	ABARO264220	8,73
1" 1/2	ABARO264224	10,93
2"	ABARO264232	13,91
2" 1/2	ABARO264240	16,51
3"	ABARO264248	20,82
4"	ABARO264264	52,50

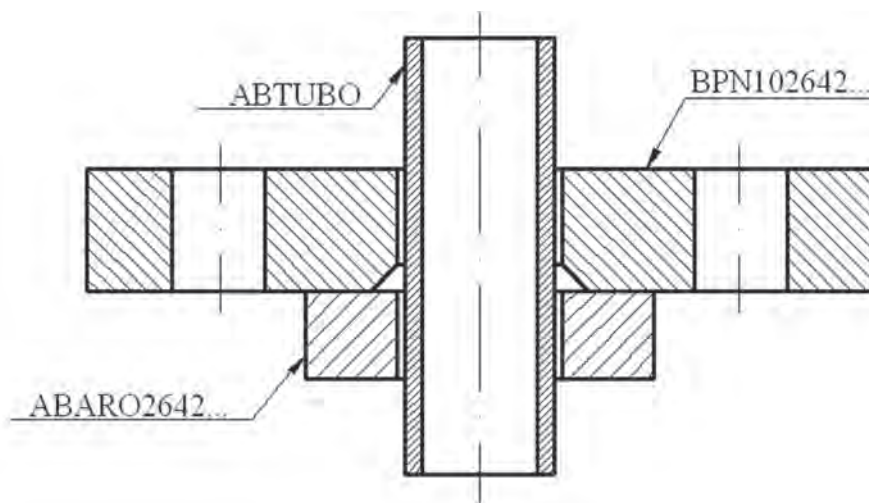

## Manguera Inox, Racores y Bidas soldables

Tuyau Inox, raccords et brides à souder  
Stainless steel hose, welding fittings and forged flanges  
Tubi Inox, raccordi e flange a saldare

### Brida loca DIN 2656 PN 40



Bride plate tournante DIN 2656 PN 40 à souder  
Swivel forged flange DIN 2656 PN 40  
Flangia girevole a saldare DIN 2656 PN 40

DN	REFERENCIA PART N°	€
3/8"	BPN40265606	4,91
1/2"	BPN40265608	5,20
3/4"	BPN40265612	5,94
1"	BPN40265616	6,62
1" 1/4	BPN40265620	8,59
1" 1/2	BPN40265624	11,62
2"	BPN40265632	13,92
2" 1/2	BPN40265640	18,92
3"	BPN40265648	23,82
4"	BPN40265664	33,15

### Tubo soldar brida ANSI-DIN



Tube à souder brides ANSI-DIN  
Tube for welding flanges ANSI-DIN  
Tubo per flangia a saldare ANSI-DIN

DN	REFERENCIA PART N°	€
3/8"	ABTUB006	1,74
1/2"	ABTUB008	1,83
3/4"	ABTUB012	2,31
1"	ABTUB016	3,07
1" 1/4	ABTUB020	3,76
1" 1/2	ABTUB024	4,62
2"	ABTUB032	6,14
2" 1/2	ABTUB040	6,51
3"	ABTUB048	7,88
4"	ABTUB064	12,00

### Aro para brida DIN 2656

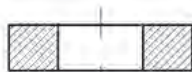

Collet épais pour brida DIN 2656  
Ring for flange DIN 2656  
Anello per flangia DIN 2656

DN	REFERENCIA PART N°	€
3/8"	ABARO265606	4,91
1/2"	ABARO265608	5,20
3/4"	ABARO265612	4,94
1"	ABARO265616	6,62
1" 1/4	ABARO265620	5,59
1" 1/2	ABARO265624	11,62
2"	ABARO265632	13,92
2" 1/2	ABARO265640	18,92
3"	ABARO265648	23,82

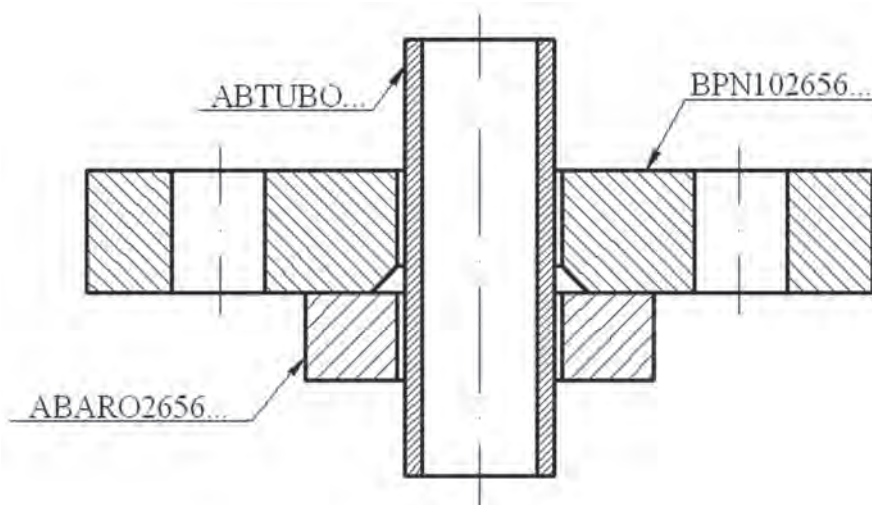

## Manguera Inox, Racores y Bridas soldables

Tuyau Inox, raccords et brides à souder  
Stainless steel hose, welding fittings and forged flanges  
Tubi Inox, raccordi e flange a saldare

Hoses

Flexible hose fittings

Stainless steel hoses and fittings

Low pressure

Air conditioned hoses and fittings

Measuring flow

Machines for mounting flexibles

### Brida ANSI-ASA 150 LBS



Bride tourn. ANSI-ASA 150 LBS  
Swivel flange ANSI-ASA 150 LBS  
Flangia ANSI-ASA 150 LBS

DN	REFERENCIA PART N°	€
1/2"	BANSASO15008	8,85
3/4"	BANSASO15012	9,20
1"	BANSASO15016	13,00
1" 1/4	BANSASO15020	18,71
1" 1/2	BANSASO15024	21,25
2"	BANSASO15032	25,14
2" 1/2	BANSASO15040	29,98
3"	BANSASO15048	37,98
4"	BANSASO15064	47,52

### Aro para brida ANSI-ASA 150/300 LBS

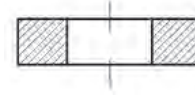

Collet épais pour bride ANSI-ASA  
Tube for welding flanges ANSI-ASA  
Anello per flangia ANSI-ASA 150/300 LBS

DN	REFERENCIA PART N°	€
1/2"	ABAROANSA08	3,22
3/4"	ABAROANSA12	3,76
1"	ABAROANSA16	5,10
1" 1/4	ABAROANSA20	5,74
1" 1/2	ABAROANSA24	7,71
2"	ABAROANSA32	11,03
2" 1/2	ABAROANSA40	15,08
3"	ABAROANSA48	19,37
4"	ABAROANSA64	23,68

### Brida ANSI-ASA 300 LBS



Bride tourn. ANSI-ASA 300 LBS  
Swivel flange ANSI-ASA 300 LBS  
Flangia ANSI-ASA 300 LBS

DN	REFERENCIA PART N°	€
1/2"	BANSASO30008	9,66
3/4"	BANSASO30012	13,65
1"	BANSASO30016	13,91
1" 1/4	BANSASO30020	20,01
1" 1/2	BANSASO30024	22,73
2"	BANSASO30032	26,40
2" 1/2	BANSASO30040	31,48
3"	BANSASO30048	39,88
4"	BANSASO30064	66,41

### Tubo soldar brida ANSI-DIN



Tube à souder brides ANSI-DIN  
Tube for welding flanges ANSI-DIN  
Tubo per flangia a saldare ANSI-DIN

DN	REFERENCIA PART N°	€
3/8"	ABTUB006	1,74
1/2"	ABTUB008	1,83
3/4"	ABTUB012	2,31
1"	ABTUB016	3,07
1" 1/4	ABTUB020	3,76
1" 1/2	ABTUB024	4,62
2"	ABTUB032	6,14
2" 1/2	ABTUB040	6,51
3"	ABTUB048	7,88
4"	ABTUB064	12,00

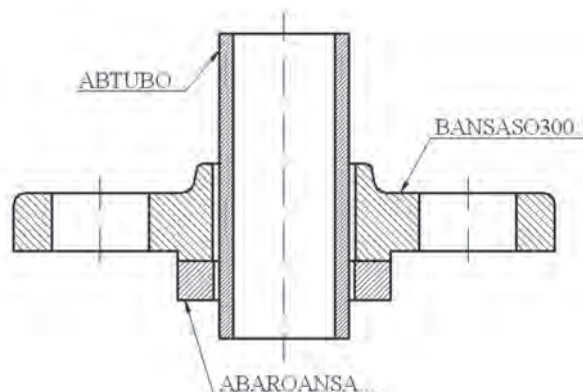
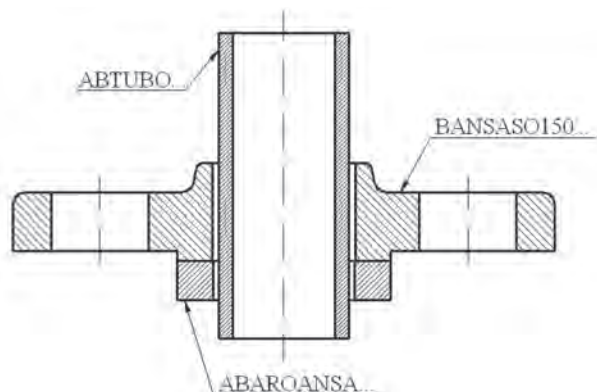

**Inox coarrugado** | Inox onduleux  
Convoluté stainless steel | Inox corrugato



Baja presión

Basse pression

Low pressure

Tubi a bassa pressione

# 4

Manguera baja presión

Tuyau basse pression | Low pressure hose | Tubi bassa pressione

94

Racores baja presión

Raccords basse pression | Low pressure fittings | Raccordi bassa pressione

95

## Manguera baja presión

Tuyau basse pression | Low pressure hose | Tubi bassa pressione

► **Mangueras de caucho sintético (gasoil)** | Tuyaux de caoutchouc synthétique (gas-oil) | Synthetic rubber hoses (diesel oil) | Tubi di caucciú sintético (diesel)



M100



M110

# Racores baja presión

Raccords basse pression | Low pressure fittings | Raccordi bassa pressione

## Casquillos (campanillas) | Jupes basse pression | Sleeves | Boccole (in acciaio sottile)

98



A5010

## Conexiones BSP | Embouts BSP basse pression | BSP Fittings | Raccordi BSP

98



D5030



D5052



D5050



D5042



D5040



D5091

## Conexiones Métricas | Embouts Métriques basse pression | Metric fittings | Raccordi Metrici

100



D5070



D5082



D5080



D5090



D5062



D5060



D5085



D5020

Hoses

Flexible hose fittings

Stainless steel hoses and fittings

Low pressure

Air conditioned hoses and fittings

Measuring flow

Machines for mounting flexibles



## Conexiones baja presión

Embouts basse pression | Low pressure fittings | Raccordi bassa pressione

Hoses

Flexible hose fittings

Stainless steel hoses  
and fittings

Low pressure

Air conditioned hoses  
and fittings

Measuring flow

Machines for  
mounting flexibles

- **Máquina prensar tubería baja presión. Ref. PMMBP** | Machine à sertir tuyaux basse pression  
Low pressure hoses crimping machine | Macchina pressatubi bassa pressione. Rif. PMMBP

### Características | Caractéristiques | Features | Caratteristiche

- **Peso** | Poids | Weight | Peso: **22 kg.**
- **Medidas (mm)** | Mesures | Measures | Misure:  
Máquina: Largo: 270 - Ancho: 130 - Alto: 260 | Machine: Longueur: 270 - Largeur: 130 - Hauteur: 260  
Machine: Length: 270 - Width: 130 - Height: 260 | Macchina: Lunghezza: 270 - Larghezza: 130 - Altezza: 260
- **Palanca apriete: Ø 33 - Longitud: 750**  
Levier: Ø 33 | Lever: Ø 33 | Leva: Ø 33
- **Tres juegos de grapas intercambiables** | 3 jeux de mors interchangeables  
3 sets of interchangeable clamps | Tre serie di morsetti
- **Ø máx. de abertura** | Ø max. d'ouverture | Ø max. opening | Ø max. apertura: **56 mm.**
- **Ø máx. de campana** | Ø max. de jupe | Ø max. ferrule | Ø max. boccola: **40 mm.**
- **Ø ext. máx. de campana** | Ø ext. de jupe | Ø ext. ferrule | Ø esterno max. boccola: **40 mm.**
- **Ø ext. mín. de campana** | Ø ext. min. de jupe | Ø ext. min. ferrule | Ø esterno min. boccola: **10 mm.**
- **Ø de prensado según grapas mm.** | Ø sertissage selon mors mm  
Crimping Ø According Clamps mm. | Ø di pressatura secondo morsetti mm.:  
**Grandes** | Grandes | Big | Grande: **Máx. 37 - Mín. 21**  
**Medianas** | Moyennes | Medium | Media: **Máx. 25 - Mín. 13**  
**Pequeñas** | Petites | Small | Piccola: **Máx. 17 - Mín. 6**



- **Máquina prensar tubería baja presión. Ref. PMBP-HF** | Machine à sertir tuyaux basse pression  
Low pressure hoses crimping | Macchina pressatubi bassa pressione. Rif. PMBP-HF

### Características | Caractéristiques | Features | Caratteristiche

- **Peso** | Poids | Weight | Peso: **40 kg.**
- **Medidas (mm)** | Mesures | Measures | Misure:  
Máquina: Largo: 330 - Ancho: 130 - Alto: 740 | Machine: Longueur: 330 - Largeur: 130 - Hauteur: 740  
Machine: Length: 330 - Width: 130 - Height: 740 | Macchina: Lunghezza: 330 - Larghezza: 130 - Altezza: 740
- **Dos posiciones de apriete** | 2 positions de sertissage  
2 crimping positions | Due posizioni di chiusura  
**Hacia garras** ①  **Hacia manetas** ②  
Vers Mors | Vers Poignées  
To Clamps | To Handles  
Verso morsetto | Verso manopole
- **Dos juegos de grapas intercambiables** | 2 jeux de mors interchangeables  
2 sets of interchangeable clamps | Due serie di morsetti
- **Apertura máx. con garras grandes** | Overture max. avec mors grands  
Max. Opening with Big Clamps | Massima apertura con morsetto grande  

	Pos. 1	Pos. 2
<b>Máx.</b>	<b>41</b>	<b>37</b>
<b>Mín.</b>	<b>23</b>	<b>21</b>
- **Apertura máx. con garras pequeñas** | Overture max. avec mors petits  
Max. Opening with Small Clamps | Massima apertura con morsetto piccolo  

	Pos. 1	Pos. 2
<b>Máx.</b>	<b>31</b>	<b>26</b>
<b>Mín.</b>	<b>10</b>	<b>9</b>



## Manguera baja presión

Tuyau basse pression  
Low pressure hose  
Tubi bassa pressione

### Manguera de caucho sintético con una malla de acero galvanizado

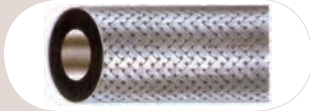

Tuyau de caoutchouc synthétique avec une tresse d'acier galvanisé  
Synthetic rubber hose with a galvanized steel braided  
Tubo di caucciú sintético con una maglia di acciaio galvanizzato

Ø in	REFERENCIA PART N°	€
5	M10005	4,17
6	M10006	4,89
7	M10007	5,15
8	M10008	5,87
9	M10009	6,64
12	M10012	9,58
14	M10014	10,45
15	M10015	12,51
18	M10018	17,65
20	M10020	16,69
22	M10022	18,49
25	M10025	21,78
30	M10030	27,76
40	M10040	69,01
50	M10050	92,65

### Manguera de caucho sintético con una malla textil de alta tenacidad



Tuyau de caoutchouc synthétique avec une tresse textile d'haute tenacité  
Synthetic rubber hose with a textile braided high toughness  
Tubo di caucciú sintético con una maglia tessile ad alta resistenza

Ø in	REFERENCIA PART N°	€
4	M11004	3,76
5	M11005	4,12
6	M11006	4,74
7	M11007	5,30
8	M11008	5,20
9	M11009	6,64
12	M11012	10,09

## Racores baja presión

Raccords basse pression  
Low pressure fittings  
Raccordi bassa pressione

Hoses

Flexible hose fittings

Stainless steel hoses  
and fittings

Low pressure

Air conditioned hoses  
and fittings

Measuring flow

Machines for  
mounting flexibles

### Campanillas de plancha para manguera de baja presión



Jupes acier doux malléable pour tuyau basse pression

Sleeves for low pressure hose

Boccola in acciaio sottile per tubo bassa pressione

Ø in	REFERENCIA PART N°	€
10,5	A50101050000	0,29
12	A50101200000	0,31
13,5	A50101350000	0,32
14,5	A50101450000	0,33
15,5	A50101550000	0,35
17	A50101700000	0,42
18,5	A50101850000	0,43
20,5	A50102050000	0,52
22,5	A50102250000	0,60
24,5	A50102450000	0,69
26	A50102600000	0,80
28	A50102800000	0,84
30	A50103000000	1,27
33	A50103300000	1,22
42	A50104200000	4,66
56	A50105600000	5,76
61	A50106100000	7,29
71	A50107100000	8,44

### Tuerca BSP

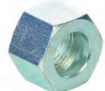

Ecrou BSP

BSP Nut

Dado BSP

ROSCA THREAD	REFERENCIA PART N°	€
1/4" BSP	D50300400000	0,69
3/8" BSP	D50300600000	0,76
1/2" BSP	D50300800000	1,07
3/4" BSP	D50301200000	1,49
1" BSP	D50301600000	2,57
1" 1/4 BSP	D50302000000	6,93
1" 1/2 BSP	D50302400000	8,17
2" BSP	D50303200000	14,00

### Boquilla asiento cónico 60° (BSP) baja presión



Nipple embout femelle BSP 60° basse pression

BSP Nipple 60° cone low pressure

Inserto cono 60° BSP bassa pressione

TUBO PIPE	TUERCA NUT	REFERENCIA PART N°	€
5-6	1/4"	D50520405000	1,14
7-8	1/4"	D50520407000	0,82
7-8	3/8"	D50520607000	1,16
9-10	3/8"	D50520609000	0,89
12-13	1/2"	D50520812000	0,96
15-16	1/2"	D50520815000	0,96
15-16	3/4"	D50521216000	1,88
19-20	3/4"	D50521220000	1,44
19-20	1"	D50521620000	3,82
25	1"	D50521625000	3,02
30	1" 1/4	D50522030000	6,18
40	1" 1/2	D50522440000	10,09
50	2"	D50523250000	16,81

## Racores baja presión

Raccords basse pression  
Low pressure fittings  
Raccordi bassa pressione

### Boquilla asiento plano (BSP) baja presión



Nipple embout femelle fond plat BSP basse pression  
BSP Nipple flat seat  
Inserto faccia piana BSP bassa pressione

TUBO PIPE	TUERCA NUT	REFERENCIA PART N°	€
5-6	1/4"	D50500405000	1,20
7-8	1/4"	D50500407000	1,18
9-10	3/8"	D50500609000	1,26
12-13	1/2"	D50500812000	1,33
15-16	1/2"	D50500815000	1,40
15-16	3/4"	D50501216000	1,88
19-20	3/4"	D50501220000	1,88
19-20	1"	D50501620000	3,82
25	1"	D50501625000	3,61
30	1" 1/4	D50502030000	7,46
40	1" 1/2	D50502440000	14,37
50	2"	D50503250000	20,54

### Macho BSP rosca cilíndrica asiento cónico 60°



Embout mâle fixe BSP cône 60° basse pression  
BSP Cylindrical male low pressure 60° cone  
Maschio BSP cilindrico sede conica 60° bassa pressione

TUBO PIPE	ROSCA THREAD	REFERENCIA PART N°	€
5-6	1/4"	D50420405000	2,09
7-8	1/4"	D50420407000	2,13
7-8	3/8"	D50420607000	2,28
9-10	3/8"	D50420609000	2,06
12-13	3/8"	D50420612000	2,68
12-13	1/2"	D50420812000	3,91
15-16	1/2"	D50420815000	2,77
15-16	3/4"	D50421216000	4,07
19-20	3/4"	D50421220000	3,28
19-20	1"	D50421620000	8,21
25	1"	D50421625000	5,19
30	1" 1/4	D50422030000	17,31
40	1" 1/2	D50422440000	20,82
50	2"	D50423250000	29,92

### Macho BSP rosca cilíndrica asiento plano



Embout mâle gaz fond plat basse pression  
Low pressure BSP cylindrical male flat seat  
Maschio BSP cilindrico sede piana bassa pressione

TUBO PIPE	ROSCA THREAD	REFERENCIA PART N°	€
5-6	1/8"	D50400205000	1,49
5-6	1/4"	D50400405000	2,09
7-8	1/4"	D50400407000	2,01
7-8	3/8"	D50400607000	2,28
9-10	3/8"	D50400609000	2,28
12-13	1/2"	D50400812000	2,55
15-16	1/2"	D50400815000	2,77
15-16	3/4"	D50401216000	4,07
19-20	3/4"	D50401220000	3,96
19-20	1"	D50401620000	7,14
25	1"	D50401625000	6,57
30	1" 1/4	D50402030000	18,74
40	1" 1/2	D50402440000	22,16
50	2"	D50403250000	30,49

### Codo 90° baja gas cono 60°



Embout femelle 90° gaz cyl BSP 60° basse pression  
90° BSP Swivel female 60° cone low pressure  
Femmina a 90° sede 60° bassa pressione

TUBO PIPE	ROSCA THREAD	REFERENCIA PART N°	€
5-6	1/4"	D50910405000	5,62
7-8	1/4"	D50910407000	5,62
7-8	3/8"	D50910607000	4,80
9-10	3/8"	D50910609000	7,40
12-13	1/2"	D50910812000	8,14
15-16	1/2"	D50910815000	8,14
15-16	3/4"	D50911216000	17,05
19-20	3/4"	D50911220000	16,62
19-20	1"	D50911620000	25,07
25	1"	D50911625000	22,39
30	1" 1/4	D50912030000	58,98

## Racores baja presión

Raccords basse pression  
Low pressure fittings  
Raccordi bassa pressione

### Tuerca Métrica



Écrou métrique  
Metric nut  
Dado Metrico

ROSCA THREAD	REFERENCIA PART N°	€
M10X1	D50701000000	0,88
M12X1,5	D507012000000	0,98
M14X1,5	D507014000000	1,23
M16X1,5	D507016000000	1,33
M18X1,5	D507018000000	1,58
M22X1,5	D507022000000	2,12
M26X1,5	D507026000000	2,87

### Boquilla en codo 90° asiento cónico 60° (métrico) baja presión



Nipple en embout femelle 90° DIN métrique cône 60° basse pression  
Nipple in 90° metric swivel female tapered seat low pressure  
Femmina a 90° Metrica sede conica 60°

TUBO PIPE	ROSCA THREAD	REFERENCIA PART N°	€
5-6	10X1	D50901006000	6,40
7-8	12X1,5	D50901207000	6,82
9-10	14X1,5	D50901409000	7,14
9-10	16X1,5	D50901609000	7,97
9-10	18X1,5	D50901810000	8,40
15-16	22X1,5	D50902215000	10,62
15-16	26X1,5	D50902615000	34,24

### Boquilla asiento cónico 60° (Métrica) baja presión



Nipple pour embout femelle DIN métrique cône 60° basse pression  
Metric nipple 60° cone low pressure  
Inserto cono 60° Metrico bassa pressione

TUBO PIPE	TUERCA NUT	REFERENCIA PART N°	€
5-6	10X1	D50821005000	1,27
7-8	12X1,5	D50821207000	1,42
9-10	14X1,5	D50821409000	1,49
9-10	18X1,5	D50821810000	1,92
12-13	22X1,5	D50822212000	2,12
15-16	22X1,5	D50822215000	2,12
12-13	26X1,5	D50822612000	3,57
15-16	26X1,5	D50822615000	3,57

### Macho rosca Métrica asiento cónico 60° baja presión



Embout mâle DIN métrique cône 60° basse pression  
Metric cylindrical male 60° cone  
Maschio Metrico sede conica 60° bassa pressione

TUBO PIPE	ROSCA THREAD	REFERENCIA PART N°	€
5-6	10X1	D50621005000	1,39
7-8	12X1,5	D50621207000	1,75
9-10	14X1,5	D50621409000	2,62
9-10	16X1,5	D50621609000	3,02
12-13	16X1,5	D50621612000	3,32
9-10	18X1,5	D50621810000	3,69
12-13	22X1,5	D50622212000	4,35
15-16	22X1,5	D50622215000	4,35
12-13	26X1,5	D50622612000	4,98
15-16	26X1,5	D50622615000	4,98

### Boquilla asiento plano (Métrica) baja presión



Nipple pour embout femelle métrique fond plat basse pression  
Metric nipple flat seat low pressure  
Inserto faccia piana bassa pressione

TUBO PIPE	TUERCA NUT	REFERENCIA PART N°	€
5-6	10X1	D50801005000	1,28
7-8	12X1,5	D50801207000	1,42
9-10	14X1,5	D50801409000	1,49
9-10	16X1,5	D50801609000	1,34
9-10	18X1,5	D50801810000	1,34
12-13	22X1,5	D50802212000	2,12
15-16	22X1,5	D50802215000	1,59
12-13	26X1,5	D50802612000	3,57
15-16	26X1,5	D50802615000	3,57

### Macho rosca Métrica asiento plano baja presión



Embout mâle métrique fond plat basse pression  
Metric cyl male flat seat low pressure  
Maschio Metrico sede piana bassa pressione

TUBO PIPE	ROSCA THREAD	REFERENCIA PART N°	€
5-6	10X1	D50601005000	2,19
7-8	12X1,5	D50601207000	2,52
9-10	14X1,5	D50601409000	2,62
9-10	16X1,5	D50601609000	3,02
12-13	16X1,5	D50601612000	2,60
9-10	18X1,5	D50601810000	3,69
12-13	22X1,5	D50602212000	2,45
15-16	22X1,5	D50602215000	2,45
12-13	26X1,5	D50602612000	4,99
15-16	26X1,5	D50602615000	4,99

## Racores baja presión

Raccords basse pression  
Low pressure fittings  
Raccordi bassa pressione

### Espiga lisa Métrica baja presión



Embout lisse métrique basse pression  
Metric standpipe low pressure  
Estremitá tubolare Metrica bassa pressione

TUBO PIPE		REFERENCIA PART N°	€
5-6	4	D50850405000	4,61
5-6	6	D50850606000	2,62
5-6	8	D50850806000	2,62
7-8	8	D50850808000	2,62
7-8	10	D50851008000	2,82
9-10	10	D50851010000	2,82
12-13	12	D50851212000	2,94
15-16	15	D50851515000	4,69
15-16	18	D50851815000	4,74

### Orientable métrico baja presión



Embout banjo métrique basse pression  
Low pressure metric banjo  
Raccordo ad occhio Metrico bassa pressione

TUBO PIPE	Ø	REFERENCIA PART N°	€
5-6	8	D50200805	3,62
7-8	8	D50200807	3,62
5-6	10	D50201005	3,96
7-8	10	D50201007	3,96
9-10	10	D50201009	4,03
5-6	12	D50201205	4,12
7-8	12	D50201207	4,12
9-10	12	D50201209	4,12
5-6	14	D50201405	4,25
7-8	14	D50201407	4,25
9-10	14	D50201409	4,25

# Aire acondicionado

Climatisation

Air conditioning hoses and fittings

Aria condizionata





# Mangueras

Tuyaux | Hoses | Tubi

Hoses

Flexible hose fittings

Stainless steel hoses and fittings

Low pressure

Air conditioned hoses and fittings

Measuring flow

Machines for mounting flexibles



**Mangueras Freón Barrier N (polivalente) Freón 134, 12, 14...** | Tuyaux Freon Barrier N (Polyvalent) Freón 134, 12, 14... | Air Conditioning Barrier N Hose | Tubo Freón Barrier N (polivalente) Freón 134, 12, 14...

Tubo   Tuyau DN Hose   Tubi	Galga   Pige Gauge   Size	Referencia   Référence Part No.   Codice	€
BARRIER N 5/16	6	M520006	11,88
BARRIER N 13/32	8	M520008	13,97
BARRIER N 1/2	10	M520010	15,91
BARRIER N 5/8	12	M520012	17,46

► **Está compuesta por dos capas de caucho NBR con una fina capa de nylon entre ellas. Una malla textil resistente al calor y elementos químicos. Cubierta exterior de EPDM.**

Ce tuyau est composé de deux nappes de caoutchouc NBR avec une fine couche de nylon entre elles. Une tresse textile qui résiste à la chaleur et aux éléments chimiques. Revêtement extérieur d'EPDM.

This hose is manufactured with a thin nylon layer between two layers of rubber NBR. One textile braid reinforcement resistant to heat and chemical elements. Outer cover of EPDM.

É composto da due strati di gomma NBR con un sottile strato di nylon nel mezzo. Una maglia tessile resistente al calore e agli elementi chimici. Rivestimento esterno di EPDM.

**Aplicaciones** | Applications | Applicazioni | Applicazioni

**Utilización con refrigerantes HFC-134a y CFC-12** | Utilisation avec réfrigérants HFC-134a et CFC-12  
Using with refrigerants HFC-134a and CFC-12 | Utilizzo con refrigeranti HFC-134a e CFC-12

**Temperatura de trabajo** | Température | Working pressure | Temperatura di lavoro

**-30 / 95 °C**

DN		5/16" (8 mm)	13/32" (10 mm)	1/2" (13 mm)	5/8" (16 mm)
Diámetro interior   Diamètre intérieur Inner diameter   Diametro interno	(in)	0.322	0.418	0.512	0.637
	(mm)	8.2	10.6	13	16.2
Diámetro exterior   Diamètre extérieur Outer diameter   Diametro esterno	(in)	0.750	0.906	1	1.125
	(mm)	19.1	23	25.4	28.6
Presión de rotura   Pression de rupture Burst pressure   Pressione di rottura	(psi)	2000	2000	2000	1750
	(bar)	140	140	140	122

► **Presna manual** | Presse manuelle | Manual Press Machine | Pressa manuale

**Presna Freón. Ref. V001040 (sin juegos de mordazas)** | Presse Freon. Ref. V001040 | Air conditioning hose crimping machine | Presse Freon Rif. V001040 (senza serie di morsetti)

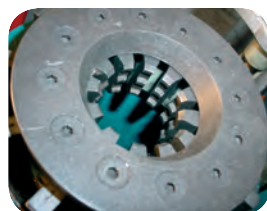
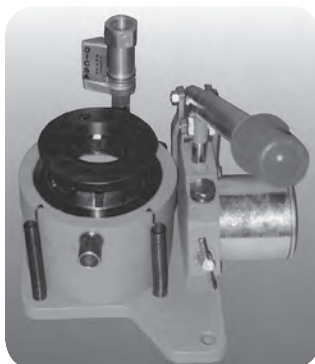





















► **Presnas eléctricas** | Presse électrique | Electric Press Machine | Pressa elettriche



**Disponemos de garras de freón para las presnas SE 25 - PE 25 / 32 / 38 / 50 / 4-50 - PE 180 - PES 50...** | Nous avons mors de freon pour les presses SE 25 - PE 25 / 32 / 38 / 50 / 4-50 - PE 180 - PES 50... | We have air conditioning clamps for the following machines SE 25 - PE 25 / 32 / 38 / 50 / 4-50 - PE 180 - PES 50... | Disponiamo di morsetti da Freon per le presse SE25 - PE 25 / 32 / 38 / 50 / 4-50 - PE 180 - PES 50...

## Racores aire acondicionado

Raccords climatisation | Air conditioning fittings | Raccordi aria condizionata

- ▶ **Rotalock sin válvula** | Raccords Rotalock sans vanne | Rotalock without valve | Raccordi Rotalock senza valvola 107
- 



- FXR
FX90
FX45
FXA90
- 
- ▶ **Rotalock con válvula** | Raccords Rotalock avec vanne | Rotalock with valve | Raccordi Rotalock con valvola 107
- 



- FXRV
FX45V
FX90V
FXAV90
- 
- ▶ **Racores de unión** | Raccord union | Couplings | Raccordi di unione 108
- 

- 134 URTV
URT
- 
- ▶ **Hembras con junta tórica sin válvula** | Femelles tournantes avec joint vert sans vanne | Swivel female with green joint | Femmine con o'ring senza valvola 108
- 

- FOR
FO45
FO90
- 
- ▶ **Hembras con junta tórica con válvula** | Femelles tournantes avec joint vert et avec vanne | Swivel female with green joint with valve | Femmine con o'ring e valvola 108
- 

- FORV
FO90V
FO45V
- 
- ▶ **Machos con junta tórica** | Mâles avec joint vert | Males with green joint | Maschi con o'ring 109
- 

- MOR
MO45
MO90
- 
- ▶ **Adaptadores** | Adapteurs climatisation pour Freón | Adaptors | Adattatori 109
- 

- BRV
BORV

Hoses

Flexible hose fittings

Stainless steel hoses  
and fittings

Low pressure

Air conditioned hoses  
and fittings

Measuring flow

Machines for  
mounting flexibles

Hoses

▶ **Conexiones rosca SAE** | Femelles tournantes SAE | Swivel females SAE | Raccordi SAE

110



FSR



FS90



FS45

Flexible hose fittings

▶ **Conexiones con válvula para Freón 12** | Embouts climatisation pour Freón 12 avec vanne | Fittings with valve for air conditioning 12 | Raccordi con valvola per Freon 12

110



FXRV



FXAV90



URTV



FX90V

Stainless steel hoses and fittings

▶ **Juntas tóricas para racores Freón 134** | Joints toriques spéciaux pour Freón 134 | Joints for air conditioning 134 fittings | O'rings per raccordi per Freon 134

111



\* FREON

Low pressure

▶ **Racores recuperables** | Raccords climatisation récupérables | Reusable fittings | Raccordi recuperabili

111



CRF

Air conditioned hoses and fittings

Measuring flow

Machines for mounting flexibles

## Racores aire acondicionado

Raccords climatisation  
Air conditioning fittings  
Raccordi aria condizionata

### Hembra recta con junta Rotalock



Femelle climatisation droite Rotalock avec raccord tube "o" compresseur  
Straight female with Rotalock joint  
Femmina diritta con guarnizione Rotalock

DN	ROSCA THREAD	REFERENCIA PART N°	€
13/32"	1" 14h UNS	<b>FXR 1108</b>	<b>11,47</b>
1/2"	1" 14h UNS	<b>FXR 1110</b>	<b>11,88</b>
5/8"	1" 14h UNS	<b>FXR 1112</b>	<b>17,06</b>

### Hembra 90° con junta Rotalock



Femelle climatisation 90° Rotalock avec raccord tube 90° "o" compresseur  
90° Female with Rotalock joint  
Femmina a 90° con guarnizione Rotalock

DN	ROSCA THREAD	REFERENCIA PART N°	€
13/32"	1" 14h UNS	<b>FX90 1108</b>	<b>12,83</b>
1/2"	1" 14h UNS	<b>FX90 1110</b>	<b>13,65</b>
5/8"	1" 14h UNS	<b>FX90 1112</b>	<b>19,52</b>

### Hembra recta con junta Rotalock y válvula 134



Femelle droite Rotalock avec joint et vanne pour 134  
Straight female with Rotalock joint and 134 valve  
Femmina diritta con guarnizione Rotalock e valvola 134

DN	ROSCA THREAD	REFERENCIA PART N°	€
13/32"	1" 14h UNS	<b>134 FXRV 1108</b>	<b>20,88</b>
1/2"	1" 14h UNS	<b>134 FXRV 1110</b>	<b>21,43</b>
5/8"	1" 14h UNS	<b>134 FXRV 1112</b>	<b>23,61</b>

### Hembra 45° con junta Rotalock y válvula 134



Femelle 45° Rotalock avec joint et vanne pour 134  
45° Female with Rotalock joint and 134 valve  
Femmina a 45° con guarnizione Rotalock e valvola 134

DN	ROSCA THREAD	REFERENCIA PART N°	€
13/32"	1" 14h UNS	<b>134 FX45V 1108</b>	<b>23,34</b>
1/2"	1" 14h UNS	<b>134 FX45V 1110</b>	<b>22,39</b>

### Hembra 45° con junta Rotalock



Femelle climatisation 45° Rotalock avec raccord tube 45° "o" compresseur  
45° Female with Rotalock joint  
Femmina a 45° con guarnizione Rotalock

DN	ROSCA THREAD	REFERENCIA PART N°	€
13/32"	1" 14h UNS	<b>FX45 1108</b>	<b>12,69</b>
1/2"	1" 14h UNS	<b>FX45 1110</b>	<b>13,65</b>
5/8"	1" 14h UNS	<b>FX45 1112</b>	<b>19,38</b>

### Hembra especial 90° con junta Rotalock



Femelle climatisation spéciale 90° rotalock avec raccord tube 90° spécial "o" compresseur  
90° Special female with Rotalock joint  
Femmina a 90° speciale con guarnizione Rotalock

DN	ROSCA THREAD	REFERENCIA PART N°	€
13/32"	1" 14h UNS	<b>FXA90 1108</b>	<b>20,07</b>
1/2"	1" 14h UNS	<b>FXA90 1110</b>	<b>20,34</b>

### Hembra 90° con junta Rotalock y válvula 134



Femelle 90° Rotalock avec joint et vanne pour 134  
90° Female with Rotalock joint and 134 valve  
Femmina a 90° con guarnizione Rotalock e valvola 134

DN	ROSCA THREAD	REFERENCIA PART N°	€
13/32"	1" 14h UNS	<b>134 FX90V 1108</b>	<b>21,98</b>
1/2"	1" 14h UNS	<b>134 FX90V 1110</b>	<b>22,52</b>
5/8"	1" 14h UNS	<b>134 FX90V 1112</b>	<b>26,07</b>

### Hembra especial 90° con junta Rotalock y válvula 134



Femelle climatisation spéciale 90° Rotalock avec joint et vanne pour 134  
90° special Female with Rotalock joint and 134 valve  
Femmina a 90° speciale con guarnizione Rotalock e valvola 134

DN	ROSCA THREAD	REFERENCIA PART N°	€
13/32"	1" 14h UNS	<b>134 FXAV90 1108</b>	<b>26,75</b>
1/2"	1" 14h UNS	<b>134 FXAV90 1110</b>	<b>27,03</b>

## Racores aire acondicionado

Raccords climatisation  
Air conditioning fittings  
Raccordi aria condizionata

Hoses

### Racor de unión con válvula 134



Raccord d'union climatisation avec vanne pour splicer vanne pour r134  
134 valve coupling  
Raccordo di unione tubi con valvola 134

DN	REFERENCIA PART N°	€
5/16"	134 URTV 0006	21,16
13/32"	134 URTV 0008	22,52
1/2"	134 URTV 0010	22,66
5/8"	134 URTV 0012	22,93

Flexible hose fittings

### Racor de unión



Raccord d'union climatisation splicer  
Hose-hose coupling  
Raccordo di unione tubo-tubo

DN	REFERENCIA PART N°	€
5/16"	URT 0006	9,69
13/32"	URT 0008	9,96
1/2"	URT 0010	11,33
5/8"	URT 0012	11,88

Stainless steel hoses  
and fittings

### Hembra giratoria recta con junta verde



Femelle tournante avec joint vert  
Straight swivel female with green joint  
Femmina diritta con o'ring verde

DN	ROSCA THREAD	REFERENCIA PART N°	€
5/16"	5/8" 18h UNF	FOR 0606	8,05
13/32"	3/4" 16h UNF	FOR 0808	8,60
1/2"	7/8" 14h UNF	FOR 1010	9,83
5/8"	7/8" 14h UNF	FOR 1012	10,92
5/8"	1" 1/16 12h UNF	FOR 1212	12,97

Low pressure

### Hembra giratoria 90° con junta verde



Femelle tournante 90° avec joint vert  
90° swivel female with green joint  
Femmina a 90° con o'ring verde

DN	ROSCA THREAD	REFERENCIA PART N°	€
5/16"	5/8" 18h UNF	FO90 0606	9,15
13/32"	3/4" 16h UNF	FO90 0808	9,69
1/2"	7/8" 14h UNF	FO90 1010	10,51
5/8"	7/8" 14h UNF	FO90 1012	11,47
5/8"	1" 1/16 12h UNF	FO90 1212	13,92

Air conditioned hoses  
and fittings

### Hembra giratoria 45° con junta verde



Femelle tournante 45° avec joint vert  
45° swivel female with green joint  
Femmina a 45° con o'ring verde

DN	ROSCA THREAD	REFERENCIA PART N°	€
5/16"	5/8" 18h UNF	FO45 0606	8,87
13/32"	3/4" 16h UNF	FO45 0808	9,69
1/2"	7/8" 14h UNF	FO45 1010	10,51
5/8"	7/8" 14h UNF	FO45 1012	11,47
5/8"	1" 1/16 12h UNF	FO45 1212	13,92

Measuring flow

### Hembra orientable recta con válvula



Femelle tournante avec joint vert et vanne pour 134  
Straight swivel female with green joint and valve  
Femmina diritta con o'ring verde e valvola 134

DN	ROSCA THREAD	REFERENCIA PART N°	€
5/16"	5/8" 18h UNF	FORV 0606	17,47
13/32"	3/4" 16h UNF	FORV 0808	18,02
1/2"	7/8" 14h UNF	FORV 1010	18,56
5/8"	7/8" 14h UNF	FORV 1012	19,66
5/8"	1" 1/16 12h UNF	FORV 1212	22,25

Machines for  
mounting flexibles

### Hembra orientable 90° con válvula



Femelle tournante 90° avec joint vert et vanne pour 134  
90° Swivel female with green joint and valve  
Femmina a 90° con o'ring verde e valvola 134

DN	ROSCA THREAD	REFERENCIA PART N°	€
5/16"	5/8" 18h UNF	FO90V 0606	19,38
13/32"	3/4" 16h UNF	FO90V 0808	20,20
1/2"	7/8" 14h UNF	FO90V 1010	20,34
5/8"	7/8" 14h UNF	FO90V 1012	20,34
5/8"	1" 1/16 12h UNF	FO90V 1212	24,57

## Racores aire acondicionado

Raccords climatisation  
Air conditioning fittings  
Raccordi aria condizionata

### Hembra orientable 45° con válvula



Femelle tournante 45° avec joint vert et vanne pour 134  
45° Swivel female with green joint and valve  
Femmina a 45° con o'ring verde e valvola 134

DN	ROSCA THREAD	REFERENCIA PART N°	€
5/16"	5/8" 18h UNF	FO45V 0606	18,43
13/32"	3/4" 16h UNF	FO45V 0808	19,25
1/2"	7/8" 14h UNF	FO45V 1010	19,66
5/8"	7/8" 14h UNF	FO45V 1012	20,34
5/8"	1" 1/16 12h UNF	FO45V 1212	24,43

### Macho recto con junta tórica



Mâle tournant avec joint vert  
Straight male with green joint  
Maschio diritto con o'ring

DN	ROSCA THREAD	REFERENCIA PART N°	€
5/16"	5/8" 18h UNF	MOR 0606	8,05
13/32"	3/4" 16h UNF	MOR 0808	8,60
1/2"	7/8" 14h UNF	MOR 1010	10,24
5/8"	7/8" 14h UNF	MOR 1012	11,79
5/8"	1" 1/16 12h UNF	MOR 1212	13,24

### Macho 90° con junta tórica



Mâle tournant 90° avec joint vert  
90° Male with green joint  
Maschio a 90° con o'ring

DN	ROSCA THREAD	REFERENCIA PART N°	€
5/16"	5/8" 18h UNF	MO90 0606	9,15
13/32"	3/4" 16h UNF	MO90 0808	9,83
1/2"	7/8" 14h UNF	MO90 1010	11,19
5/8"	7/8" 14h UNF	MO90 1012	12,56
5/8"	1" 1/16 12h UNF	MO90 1212	14,47

### Macho 45° con junta tórica



Mâle tournant 45° avec joint vert  
45° Male with green joint  
Maschio a 45° con o'ring

DN	ROSCA THREAD	REFERENCIA PART N°	€
5/16"	5/8" 18h UNF	MO45 0606	9,15
13/32"	3/4" 16h UNF	MO45 0808	9,69
1/2"	7/8" 14h UNF	MO45 1010	10,92
5/8"	7/8" 14h UNF	MO45 1012	12,56
5/8"	1" 1/16 12h UNF	MO45 1212	14,33

### Adaptador en codo con válvula macho (para hembra con junta) - hembra Rotalock



Adapteur coude compact mâle-femelle Rotalock avec vanne  
Elbow adaptor with male valve - Rotalock female  
Adattatore a 90° con valvola maschio (per femmina con guarnizione) - femmina Rotalock

ROSCA THREAD	REFERENCIA PART N°	€	
1" 14h UNS	M 3/4" 16h UNF	BRV 0808	20,75
1" 14h UNS	M 7/8" 14h UNF	BRV 1010	21,00

### Adaptador en codo con válvula macho (para hembra SAE) - hembra Rotalock



Adapteur coude compact mâle (pour femelle SAE) x femelle Rotalock avec vanne  
Elbow adaptor with male valve SAE - Rotalock female  
Adattatore a 90° con valvola maschio (per femmina SAE) - femmina Rotalock

ROSCA THREAD	REFERENCIA PART N°	€	
1" 14h UNS	M 3/4" 16h UNF	BORV 0808	18,45
1" 14h UNS	M 7/8" 14h UNF	BORV 1010	18,60

## Racores aire acondicionado

Raccords climatisation  
Air conditioning fittings  
Raccordi aria condizionata

Hoses

### Hembra giratoria recta



Femelle tournante SAE droite  
Straight swivel female SAE  
Femmina diritta SAE

DN	ROSCA THREAD	REFERENCIA PART N°	€
5/16"	5/8" 18h UNF	<b>FSR 0606</b>	<b>10,65</b>
13/32"	3/4" 16h UNF	<b>FSR 0808</b>	<b>11,60</b>
1/2"	7/8" 14h UNF	<b>FSR 1010</b>	<b>12,97</b>

Flexible hose fittings

### Codo 45° hembra giratoria



Femelle tournante 45° SAE  
45° Swivel female SAE  
Femmina a 45° SAE

DN	ROSCA THREAD	REFERENCIA PART N°	€
5/16"	5/8" 18h UNF	<b>FS45 0606</b>	<b>11,47</b>
13/32"	3/4" 16h UNF	<b>FS45 0808</b>	<b>12,83</b>
1/2"	7/8" 14h UNF	<b>FS45 1010</b>	<b>13,65</b>

Stainless steel hoses  
and fittings

### Codo 90° hembra giratoria



Femelle tournante 90° SAE  
90° Swivel female SAE  
Femmina a 90° SAE

DN	ROSCA THREAD	REFERENCIA PART N°	€
5/16"	5/8" 18h UNF	<b>FS90 0606</b>	<b>11,60</b>
13/32"	3/4" 16h UNF	<b>FS90 0808</b>	<b>12,83</b>
1/2"	7/8" 14h UNF	<b>FS90 1010</b>	<b>13,79</b>

Low pressure

### Hembra recta con junta Rotalock y válvula



Femelle droite Rotalock avec joint et vanne pour R12  
Straight female with Rotalock joint and valve  
Femmina diritta con guarnizione Rotalock e valvola

DN	ROSCA THREAD	REFERENCIA PART N°	€
13/32"	1" 14h UNS	<b>FXRV 1108</b>	<b>18,02</b>
1/2"	1" 14h UNS	<b>FXRV 1110</b>	<b>19,95</b>

Air conditioned hoses  
and fittings

### Racor de unión con válvula



Raccord union avec vanne pour R14 splicer vanne pour R12  
Union fitting with valve  
Raccordi de unione con valvola

DN	REFERENCIA PART N°	€
5/16"	<b>URTV 0006</b>	<b>15,83</b>
13/32"	<b>URTV 0008</b>	<b>16,24</b>
1/2"	<b>URTV 0010</b>	<b>16,79</b>

Measuring flow

### Hembra especial 90° con junta Rotalock y válvula



Femelle spéciale 90° Rotalock avec joint et vanne pour R12  
90° Special female with Rotalock joint and valve  
Femmina a 90° speciale con guarnizione Rotalock e valvola

DN	ROSCA THREAD	REFERENCIA PART N°	€
13/32"	1" 14h UNS	<b>FXAV90 1108</b>	<b>25,94</b>
1/2"	1" 14h UNS	<b>FXAV90 1110</b>	<b>26,21</b>

Machines for  
mounting flexibles

### Hembra 90° con junta Rotalock y válvula



Femelle 90° Rotalock avec joint et vanne pour R12  
90° Female with Rotalock joint and valve  
Femmina a 90° con guarnizione Rotalock e valvola

DN	ROSCA THREAD	REFERENCIA PART N°	€
13/32"	1" 14h UNS	<b>FX90V 1108</b>	<b>19,79</b>
1/2"	1" 14h UNS	<b>FX90V 1110</b>	<b>20,75</b>

## Racores aire acondicionado

Raccords climatisation  
Air conditioning fittings  
Raccordi aria condizionata

### Junta tórica para racores Freón 134



Joint torique spécial pour Freon 134  
Joints for air conditioning 134 fittings  
O'ring per raccordi per Freon 134

DN	REFERENCIA PART N°	€
5/16	7.65X1.78 FREON	0,70
13/32	10.82X1.78 FREON	0,80
1/2	14X1.78 FREON	1,00
5/8	18.77X1.78 FREON	1,25

### Racores recuperables cargadoras



Raccords climatisation récupérables pour chargeurs  
Reusable fittings for loaders  
Raccordi recuperabili per carico

DN	ROSCA THREAD	Descripción Description	REFERENCIA PART N°	€
3/16"	7/16"	H.G. 90°	CRFC900703	14,00
3/16"	7/16"	Casquillo	CRFM003	4,25
3/16"	7/16"	H.G. Recta	CRFTL0703	5,75

Para manguera Barrier // Pour tuyaux Barrier // For Barrier hose // Per tubi  
Barrier

Hoses

Flexible hose fittings

Stainless steel hoses  
and fittings

Low pressure

Air conditioned hoses  
and fittings

Measuring flow

Machines for  
mounting flexibles



# Metrología

Test du circuit hydraulique  
**Measuring flow**  
Test per circuiti idraulici.

# 6

Racores de control	114
Prises de contrôle   Checking fittings   Prese di pressione	
Tomas de manómetros	115
Embouts manomètres   Manometers fittings   Raccordi per manometri	
Manómetros y vacuómetros	116
Manomètres et vacuomètres   Manometers and vacuum gauges   Manometri e vacuometri	
Medidores de caudal	117
Débitmètres   Flow tester   Indicatori di flusso	

# Racores de control

Prises de contrôle | Checking fittings | Prese di pressione

Hoses

▶ **Tomas de presión 16x1.5** | Prises de pression 16x1.5 | Check couplings for manometers 16x1.5 | Prese di pressione 16x1.5 119



MPL M



MPL

Flexible hose fittings

▶ **Tomas de presión 16x2** | Prises de pression 16x2 | Check couplings for manometers 16x2 | Prese di pressione 16x2 119



MPR C/J



MPR G



MPR BSPT



MPR NPT



MPR M



MPR A

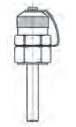

MPR TUB



MPR UNF



MPR TLM CM



MPR M CM

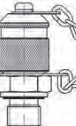

MPR CJ CM

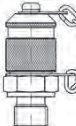

MPR G CM



MPR DL CM



27C/28C

Stainless steel hoses and fittings

▶ **Accesorios / adaptadores** | Accessoires / adapteurs minimes | Accessoires / adaptors | Accessori / adattatori 121

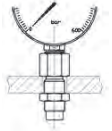

MPR PT BSP

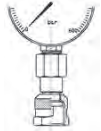

MPD BSP



MPD 90 BSP

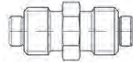

MPU



MPR PT

Low pressure

Air conditioned hoses and fittings

Measuring flow

Machines for mounting flexibles

# Tomas de manómetros

Embouts manomètres | Manometers fittings | Raccordi per manometri

► **Mangueras para tomas de manómetro** | Tuyaux capillaires minimes | Hoses for check couplings for manometers | Tubi per prese di pressione **122**



M089K

► **Conexiones para prensar** | Embouts à sertir minimes | Crimp fittings | Raccordi a pressare **122**

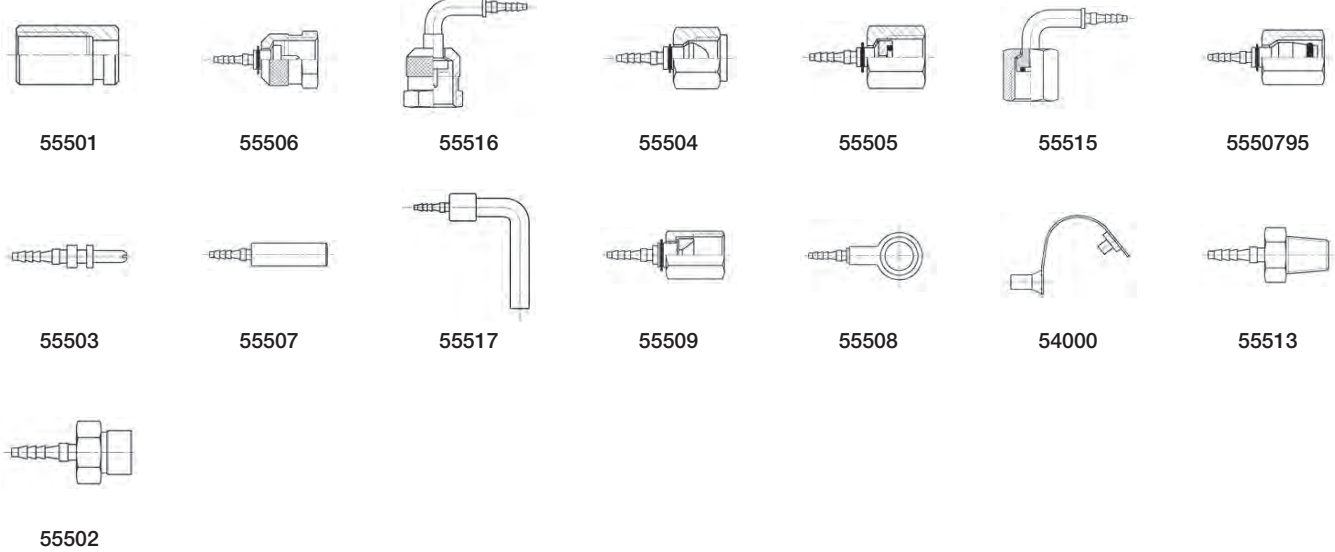

Hoses

Flexible hose fittings

Stainless steel hoses and fittings

Low pressure

Air conditioned hoses and fittings

Measuring flow

Machines for mounting flexibles

## Manómetros y vacuómetros

Manomètres et vacuomètres | Manometers and vacuum gauges | Manometri e vacuometri

Hoses

### ▶ Manómetros | Manomètres | Manometers | Manometri

124



MFI63...V



MFI63...-DB



MFI100...V



MFI100...-DB



MFI CO

Flexible hose fittings

### ▶ Vacuómetros | Vacuomètres | Vacuum gauges | Vacuometri

125



VAC6304



MFI VA

Stainless steel hoses  
and fittings

### ▶ Equipos de medición | Équipes de mesure | Check cases | Valigetta per rilevamento di pressione

125



CBOX0001



CBOX0002

Low pressure

Air conditioned hoses  
and fittings

Measuring flow

Machines for  
mounting flexibles

# Medidores de caudal

Débitmètres | Flow tester | Indicatori di flusso

## ▶ Caudalímetros 250 bar | Débitmètres 250 bar | Flow tester 250 bar | Flussostati 250 bar

126



WPB3A6H



WPB4A6H



WPB5A6H

## ▶ Caudalímetros 300-400 bar | Débitmètres 300-400 bar | Flow tester 300-400 bar | Flussostati 300-400 bar

126



FT5758



FT6068



FT5594

## ▶ Foto-tacómetro | Photo-tachymètre | Photo-tachometer | Foto-tachimetro

126



DT

Hoses

Flexible hose fittings

Stainless steel hoses and fittings

Low pressure

Air conditioned hoses and fittings

Measuring flow

Machines for mounting flexibles



## Racores de control

Prises de contrôle  
Checking fittings  
Prese di pressione

### Racor de control rosca Métrica DIN 3852



Prise de pression métrique  
Check coupling male metric thread  
Presse di pressione Metrica DIN 3852

ROSCA THREAD	Descripción Description	REFERENCIA PART N°	€
M10X1	16x1.5	<b>MPL M 10X1 CM</b>	<b>17,51</b>

Otras figuras, consultar//Pour d'autres figures, consultez-nous// For other designs, please consult us//Per altre figure, vi preghiamo di consultarci

### Racor de control rosca BSP (metálico)



Prise de pression BSP (métallique)  
Check coupling BSP (metallic)  
Presse di pressione BSP (metallico)

ROSCA THREAD	Descripción Description	REFERENCIA PART N°	€
1/8" BSP	16x1.5	<b>MPL 1/8 G CM</b>	<b>16,90</b>
1/4" BSP	16x1.5	<b>MPL 1/4 G CM</b>	<b>18,08</b>

Otras figuras, consultar//Pour d'autres figures, consultez-nous// For other designs, please consult us//Per altre figure, vi preghiamo di consultarci

### Racor de control rosca BSP con junta tórica



Prise de pression avec o'ring capouchon plastique  
Check coupling male thread BSP with o'ring  
Presse di pressione BSP con o'ring

ROSCA THREAD	Descripción Description	REFERENCIA PART N°	€
1/8" BSP	16x2	<b>MPR 1/8 C/J</b>	<b>7,80</b>
1/4" BSP	16x2	<b>MPR 1/4 C/J</b>	<b>7,63</b>
3/8" BSP	16x2	<b>MPR 3/8 C/J</b>	<b>7,80</b>
1/2" BSP	16x2	<b>MPR 1/2 C/J</b>	<b>8,16</b>

### Racor de control rosca NPT



Prise de pression NPTF avec capouchon plastique  
Check coupling male thread NPT  
Presse di pressione NPTF

ROSCA THREAD	Descripción Description	REFERENCIA PART N°	€
1/8" NPT	16x2	<b>MPR 1/8 NPT</b>	<b>7,88</b>
1/4" NPT	16x2	<b>MPR 1/4 NPT</b>	<b>7,88</b>
3/8" NPT	16x2	<b>MPR 3/8 NPT</b>	<b>9,61</b>

### Racor de control rosca BSP



Prise de pression avec capouchon plastique  
Check coupling male thread BSP  
Presse di pressione BSP

ROSCA THREAD	Descripción Description	REFERENCIA PART N°	€
1/8" BSP	16x2	<b>MPR 1/8 G</b>	<b>7,88</b>
1/4" BSP	16x2	<b>MPR 1/4 G</b>	<b>7,88</b>
3/8" BSP	16x2	<b>MPR 3/8 G</b>	<b>8,06</b>
1/4" BSP	16x2	<b>MPR 1/2 G</b>	<b>22,05</b>

### Racor de control rosca Métrica DIN 3852



Prise de pression métrique avec capouchon plastique  
Check coupling male metric thread  
Presse di pressione Metrica DIN 3852

ROSCA THREAD	Descripción Description	REFERENCIA PART N°	€
M12X1.5	16x2	<b>MPR M12X1.5</b>	<b>7,88</b>
M14X1.5	16x2	<b>MPR M14X1.5</b>	<b>7,88</b>
M16X1.5	16x2	<b>MPR M16X1.5</b>	<b>7,87</b>

### Racor de control rosca cónica BSPT



Prise de pression BSPT avec capouchon plastique  
Check coupling male BSP tapered  
Presse di pressione conica BSPT

ROSCA THREAD	Descripción Description	REFERENCIA PART N°	€
1/8" BSPT	16x2	<b>MPR 1/8 BSPT</b>	<b>7,88</b>
1/4" BSPT	16x2	<b>MPR 1/4 BSPT</b>	<b>7,88</b>
3/8" BSPT	16x2	<b>MPR 3/8 BSPT</b>	<b>16,75</b>

### Racor de control rosca Métrica (cónica)



Prise de pression métrique avec capouchon plastique  
Check coupling male metric thread  
Presse di pressione Metrica (conica)

ROSCA THREAD	Descripción Description	REFERENCIA PART N°	€
M8X1	16x2	<b>MPR A 8X1</b>	<b>7,80</b>
M10X1	16x2	<b>MPR A 10X1</b>	<b>7,80</b>
M10X1.25	16x2	<b>MPR A 10X1.25</b>	<b>7,80</b>



## Racores de control

Prises de contrôle  
Checking fittings  
Prese di pressione

Hoses

### Racor de control tubular Métrico



Prise de pression avec embout lisse capouchon plastique  
Check coupling male metric tubular  
Presse di pressione con tubolare Metrico

TUBO PIPE	Descripción Description	REFERENCIA PART N°	€
6	16x2	MPR TUB.6	7,63
8	16x2	MPR TUB.8	7,63
10	16x2	MPR TUB.10	7,63
12	16x2	MPR TUB.12	7,63
15	16x2	MPR TUB.15	7,77

Flexible hose fittings

### Racor de control rosca BSP con junta tórica (metálico)



Prise de pression BSP avec o'ring (métallique)  
Check coupling BSP with o'ring (metallic)  
Presse di pressione BSP con o-ring (metallico)

ROSCA THREAD	Descripción Description	REFERENCIA PART N°	€
1/8" BSP	16x2	MPR 1/8 C/J CM	13,12
1/4" BSP	16x2	MPR 1/4 C/J CM	13,12

Stainless steel hoses  
and fittings

### Racor de control rosca SAE - UNF



Prise de pression filetage SAE/UNF avec capouchon plastique  
Check coupling male thread UNF  
Presse di controllo SAE - UNF

ROSCA THREAD	Descripción Description	REFERENCIA PART N°	€
7/16" 20h UNF	16x2	MPR 7/16 UNF	7,80
1/2" 20h UNF	16x2	MPR 1/2 UNF	7,80
9/16" 18h UNF	16x2	MPR 9/16 UNF	7,80

Low pressure

### Racor de control rosca BSP (metálico)



Prise de pression BSP (métallique)  
Check coupling BSP (metallic)  
Presse di pressione BSP (metallico)

ROSCA THREAD	Descripción Description	REFERENCIA PART N°	€
1/8" BSP	16x2	MPR 1/8 G CM	15,59
1/4" BSP	16x2	MPR 1/4 G CM	12,95

Air conditioned hoses  
and fittings

### Racor de control hembra giratoria Métrica con junta (metálico)



Prise de pression femelle tournante Métrique + o'ring (métallique)  
Check coupling Metric swivel female + o'ring (metallic)  
Presse di pressione femmina girevole Metrica con o'ring

TUBO PIPE	ROSCA THREAD	D. D.	REFERENCIA PART N°	€
6L	M12X1.5	16x2	MPR TLM 6L CM	15,88
8L	M14X1.5	16x2	MPR TLM 8L CM	13,80
10L	M16X1.5	16x2	MPR TLM 10L CM	16,90
12L	M18X1.5	16x2	MPR TLM 12L CM	15,56
15L	M22X1.5	16x2	MPR TLM 15L CM	15,43

Otras medidas, consultar//Pour d'autres dimensions, consultez-nous// For other dimensions, please consult us//Per altre dimensioni, vi preghiamo di consultarci

Measuring flow

### Racor de control intermedio (metálico)

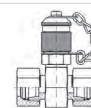

Prise de pression intermédiaire (métallique)  
Half-way check coupling (metallic)  
Presse di pressione intermedio (metallico)

TUBO PIPE	Descripción Description	REFERENCIA PART N°	€
6L	16x2	MPR DL 6 CM	22,96
8L	16x2	MPR DL 8 CM	21,33
10L	16x2	MPR DL 10 CM	23,87
12L	16x2	MPR DL 12 CM	24,11
15L	16x2	MPR DL 15 CM	25,25

Machines for  
mounting flexibles

### Racor de control macho Métrico con junta (metálico)



Prise de pression mâle + o'ring (métallique)  
Check coupling metric male + o'ring (metallic)  
Presse di pressione maschio Metrico con o'ring

ROSCA THREAD	Descripción Description	REFERENCIA PART N°	€
M10X1	16x2	MPR M 10X1 CM	8,49
M12X1.5	16x2	MPR M 12X1.5 CM	8,49

### Capuchón protector toma de presión



Capouchon plastique Minimesse  
Protective cap - check coupling for manometer  
Cappuccio di protezione per presa di pressione

CAPUCHON CAPS	REFERENCIA PART N°	€
ACERO	27CA0000	2,66
PLASTICO	28CP0000	1,46

## Racores de control

Prises de contrôle  
Checking fittings  
Prese di pressione

### Conex. manómetro-pasatabiques BSP

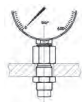

Prise de pression passe cloison sans capuchon

Check coupling BSP bulkhead for manometer

Raccordo Manometro - passaparete maschio BSP

ROSCA THREAD	REFERENCIA PART N°	€
1/4" BSP	<b>MPR PT 1/4 BSP</b>	<b>10,40</b>
1/2" BSP	<b>MPR PT 1/2 BSP</b>	<b>13,86</b>

### Conex. manómetro M-M

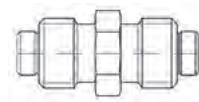

Prise de pression manomètre Mâle-Mâle

Male-Male check coupling for manometer

Adattatore M-M presa di pressione per manometro

ROSCA THREAD		REFERENCIA PART N°	€
M16X2	M16X1.5	<b>MPU 16X2</b>	<b>17,66</b>
M16X1.5	M16X1.5	<b>MPU 16X1.5</b>	<b>17,42</b>

### Conex. manómetro - toma de control



Raccord de contrôle direct à manomètre sans capuchon

Check coupling for manometer

Raccordo manometro - presa di pressione

ROSCA THREAD	REFERENCIA PART N°	€
1/4" BSP	<b>MPD 1/4 BSP</b>	<b>11,78</b>
1/2" BSP	<b>MPD 1/2 BSP</b>	<b>15,78</b>

### Conex. manómetro-hembra 90° BSP



Raccord de contrôle 90° orientable sans capuchon direct à manomètre

Check coupling 90° BSP swivel female for manometer

Raccordo manometro - femmina a 90° BSP

ROSCA THREAD	REFERENCIA PART N°	€
1/4" BSP	<b>MPD 90 1/4 BSP</b>	<b>14,32</b>
1/2" BSP	<b>MPD 90 1/2 BSP</b>	<b>16,82</b>

### Conex. Métrica para manómetros



Prise de contrôle métrique pour manomètre

Metric check coupling for manometer

Presa de pressione metrica per manometro

TUBO PIPE	ROSCA THREAD	REFERENCIA PART N°	€
8S	M16X1.5	<b>MPR PT 16X1.5</b>	<b>16,80</b>
10S	M18X1.5	<b>MPR PT 18X1.5</b>	<b>26,47</b>

## Tomas de manómetros

Embouts manomètres  
Manometers fittings  
Raccordi per manometri

Hoses

### Mangueras Minimes



Tuyaux Minimes

"Micro-Hose" hose

Micro-tubo per presa di pressione

Ø in	REFERENCIA PART N°	€
2	MT01002	3,17

Flexible hose fittings

### Casquillo manguera Minimes

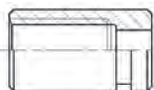

Jupe pour tuyau Minimes

Micro-hose ferrules

Boccola per Micro-tubo

DN	REFERENCIA PART N°	€
2	555010100	0,69

Stainless steel hoses and fittings

### Hembra asiento plano con junta manómetro

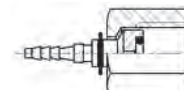

Embout femelle tournante fond plat + o'ring pour manomètre Minimes

Swivel female flat seat with o'ring for manometer Micro-hose

Femmina sede piana con o'ring per manometro

DN	ROSCA THREAD	REFERENCIA PART N°	€
2	1/4" BSP	555050404	5,19
2	1/2" BSP	555050808	8,32

Low pressure

### Hembra giratoria de control

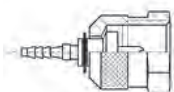

Embout femelle tournante de control Métrique Minimes

Check Metric swivel female Micro-hose

Presa di pressione femmina

DN	ROSCA THREAD	REFERENCIA PART N°	€
2	M16X1.5	555069521	5,03
2	M16X2	555069523	5,34

Air conditioned hoses and fittings

### Codo 90° hembra asiento plano con junta manómetro



Coude 90° prise de pression femelle fond plat avec o'ring

90° Swivel female flat seat with o'ring for manometer

Presa di pressione femmina 90° faccia piana con o-ring per manometro

DN	ROSCA THREAD	REFERENCIA PART N°	€
2	1/4 BSP	555150404	32,93

### Codo 90° hembra giratoria de control

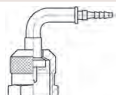

Coude 90° prise de pression femelle tournante

90° Swivel female check coupling

Presa di pressione femmina 90° girevole

DN	ROSCA THREAD	REFERENCIA PART N°	€
2	M16X2	555169523	33,20

Measuring flow

### Hembra giratoria Métrica con junta

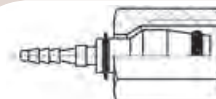

Embout femelle tournante Métrique 24° pour raccord de control + o'ring minimes

Metric swivel female with o'ring

Femmina Metrica 24° con o'ring

DN	TUBO PIPE	ROSCA THREAD	REFERENCIA PART N°	€
2	6L	M12X1.5	555079510	4,50
2	6S	M14X1.5	555079511	4,69
2	8L	M14X1.5	555079512	4,86
2	8S	M16X1.5	555079523	5,03
2	10L	M16X1.5	555079525	6,87

### Hembra giratoria recta BSP

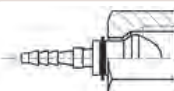

Embout femelle tournante gaz cyl BSP 60° Minimes

Straight swivel female BSP 60° cone Micro-hose

Femmina girevole BSP

DN	ROSCA THREAD	REFERENCIA PART N°	€
2	1/8" BSP	555040202	5,34
2	1/4" BSP	555040404	5,19
2	3/8" BSP	555040606	9,36

Machines for mounting flexibles

### Macho de control

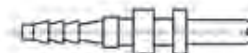

Embout mâle manomètre

Straight Micro-hose check male

Presa di pressione maschio

DN	REFERENCIA PART N°	€
2	555030325	4,17

## Tomas de manómetros

Embouts manomètres  
Manometers fittings  
Raccordi per manometri

### Espiga lisa Métrica

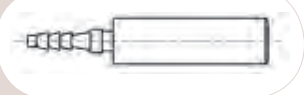

Embout lisse Métrique Minimes  
Metric standpipe Micro-hose  
Estremità tubolare Metrica

DN	TUBO PIPE	REFERENCIA PART N°	€
2	6	555070600	3,40
2	8	555070800	3,65

### Orientable Métrico

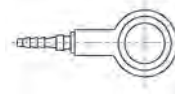

Embout Banjo Métrique Minimes  
Metric Banjo Micro-hose  
Raccordo ad occhio Metrico

DN	ROSCA THREAD	REFERENCIA PART N°	€
2	M10X1	555081000	13,86

### Espiga a 90° lisa Métrica

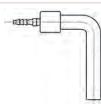

Embout lisse coude 90° Métrique Minimes  
90° Metric standpipe Micro-hose  
Estremità tubolare a 90° Metrica

DN	TUBO PIPE	REFERENCIA PART N°	€
2	6	555170600	8,64

### Hembra giratoria recta JIC 37°

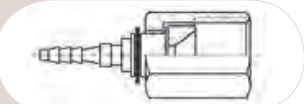

Embout femelle tournante JIC 37° Minimes  
Straight swivel female JIC 37° Micro-hose  
Femmina diritta JIC 37°

DN	ROSCA THREAD	REFERENCIA PART N°	€
2	7/16" 20h UNF	555090700	4,17
2	1/2" 20h UNF	555090800	5,54

### Protector de polvo



Protecteur de poussière  
Dust protector  
Protezione per polvere

Descripción Description	REFERENCIA PART N°	€
PLASTICO	54000000P	0,44

### Macho NPT

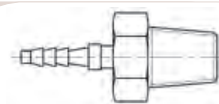

Mâle NPT  
Male NPT  
Maschio NPT

DN	ROSCA THREAD	REFERENCIA PART N°	€
2	1/8" NPT	555130200	6,94

### Macho BSP

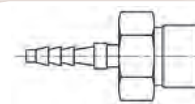

Mâle BSP  
BSP Male  
Maschio BSP

DN	ROSCA THREAD	REFERENCIA PART N°	€
2	M16X2	555020404	34,86

# Manómetros y vacuómetros

Manomètres et vacuomètres  
Manometers and vacuum gauges  
Manometri e vacuometri

Hoses

Flexible hose fittings

Stainless steel hoses and fittings

Low pressure

Air conditioned hoses and fittings

Measuring flow

Machines for mounting flexibles

## Manómetro DN 63 vertical



Manomètre DN 63 sortie verticale

Manometer DN 63 vertical connection with glycerin

Manometro DN 63 radiale a bagno di glicerina

ROSCA THREAD	ESCALA (bar) SCALE (bar)	REFERENCIA PART N°	€
1/4" BSP	0-1	MF16304001V	19,04
1/4" BSP	0-2.5	MF163042.5V	16,64
1/4" BSP	0-4	MF16304004V	16,64
1/4" BSP	0-6	MF16304006V	16,64
1/4" BSP	0-10	MF16304010V	16,64
1/4" BSP	0-12	MF16304012V	16,64
1/4" BSP	0-16	MF16304016V	16,64
1/4" BSP	0-20	MF16304020V	16,64
1/4" BSP	0-25	MF16304025V	16,64
1/4" BSP	0-40	MF16304040V	16,64
1/4" BSP	0-60	MF16304060V	18,68
1/4" BSP	0-100	MF16304100V	18,68
1/4" BSP	0-160	MF16304160V	18,68
1/4" BSP	0-250	MF16304250V	18,68
1/4" BSP	0-315	MF16304315V	18,68
1/4" BSP	0-400	MF16304400V	18,68
1/4" BSP	0-600	MF16304600V	19,67

## Manómetro DN 100 vertical



Manomètre DN 100 sortie verticale

Manometer DN 100 vertical connection with glycerin

Manometro DN 100 radiale a bagno di glicerina

ROSCA THREAD	ESCALA (bar) SCALE (bar)	REFERENCIA PART N°	€
1/2" BSP	0-1	MF110008001V	40,67
1/2" BSP	0-2.5	MF11000802.5V	39,33
1/2" BSP	0-4	MF110008004V	39,33
1/2" BSP	0-6	MF110008006V	39,33
1/2" BSP	0-10	MF110008010V	39,33
1/2" BSP	0-12	MF110008012V	39,33
1/2" BSP	0-16	MF110008016V	39,33
1/2" BSP	0-20	MF110008020V	39,33
1/2" BSP	0-25	MF110008025V	39,33
1/2" BSP	0-40	MF110008040V	39,33
1/2" BSP	0-60	MF110008060V	40,58
1/2" BSP	0-100	MF110008100V	40,58
1/2" BSP	0-160	MF110008160V	40,58
1/2" BSP	0-250	MF110008250V	40,58
1/2" BSP	0-315	MF110008315V	40,58
1/2" BSP	0-400	MF110008400V	40,58
1/2" BSP	0-600	MF110008600V	43,61

## Manómetro DN 100 dorsal



Manomètre DN 100 sortie arrière

Manometer DN 100 rear connection with glycerin

Manometro DN 100 assiale flangiato a bagno di glicerina

ROSCA THREAD	ESCALA (bar) SCALE (bar)	REFERENCIA PART N°	€
1/2" BSP	0-1	MF110008001-DB	44,74
1/2" BSP	0-2.5	MF1100082.5-DB	44,09
1/2" BSP	0-4	MF110008004-DB	44,09
1/2" BSP	0-6	MF110008006-DB	44,09
1/2" BSP	0-10	MF110008010-DB	44,09
1/2" BSP	0-16	MF110008016-DB	44,09
1/2" BSP	0-25	MF110008025-DB	44,09
1/2" BSP	0-40	MF110008040-DB	44,09
1/2" BSP	0-60	MF110008060-DB	45,48
1/2" BSP	0-100	MF110008100-DB	45,48
1/2" BSP	0-160	MF110008160-DB	45,48
1/2" BSP	0-250	MF110008250-DB	45,48
1/2" BSP	0-315	MF110008315-DB	45,48
1/2" BSP	0-400	MF110008400-DB	45,48
1/2" BSP	0-600	MF110008600-DB	47,97

## Manómetro DN 63 dorsal



Manomètre DN 63 sortie arrière

Manometer DN 63 rear connection with glycerin

Manometro DN 63 assiale flangiato a bagno di glicerina

ROSCA THREAD	ESCALA (bar) SCALE (bar)	REFERENCIA PART N°	€
1/4" BSP	0-1	MF16304001-DB	21,63
1/4" BSP	0-2.5	MF163042.5-DB	19,93
1/4" BSP	0-4	MF16304004-DB	19,93
1/4" BSP	0-6	MF16304006-DB	19,93
1/4" BSP	0-10	MF16304010-DB	19,93
1/4" BSP	0-12	MF16304012-DB	19,93
1/4" BSP	0-16	MF16304016-DB	19,93
1/4" BSP	0-20	MF16304020-DB	19,93
1/4" BSP	0-25	MF16304025-DB	19,93
1/4" BSP	0-40	MF16304040-DB	19,93
1/4" BSP	0-60	MF16304060-DB	22,07
1/4" BSP	0-100	MF16304100-DB	22,07
1/4" BSP	0-160	MF16304160-DB	22,07
1/4" BSP	0-250	MF16304250-DB	22,07
1/4" BSP	0-315	MF16304315-DB	22,07
1/4" BSP	0-400	MF16304400-DB	22,07
1/4" BSP	0-600	MF16304600-DB	22,43

## Manómetro de colores



Manomètre à couleurs

Pressure gauges in colours

Manometro a colori

ROSCA THREAD	ESCALA (bar) SCALE (bar)	REFERENCIA PART N°	€
1/8	0-6	MF1 CO 06	7,20

## Manómetros y vacuómetros

Manomètres et vacuomètres  
Manometers and vacuum gauges  
Manometri e vacuometri

### Vacuómetro DN 63 con glicerina



Vacuomètre DN 63 avec glycerine  
Vacuum gauge DN 63 with glycerin  
Vacuometro DN 63 a bagno di glicerina

ROSCA THREAD	ESCALA (bar) SCALE (bar)	REFERENCIA PART N°	€
1/4" BSP	-1-0	VAC6304-01I	19,47
1/4" BSP	-76-0	VAC6304-76I	19,47

### Vacuómetro de colores



Vacuomètre à couleurs  
Vacuum gauges in colours  
Vacuometro a colori

ROSCA THREAD	ESCALA (bar) SCALE (bar)	REFERENCIA PART N°	€
1/8	-1-0	MFI VA 01	11,06

### Maletín dos manómetros + accesorios tipo 1



Coffre 2 manomètres + accessoires type 1  
Check case 2 manometers + accessories type 1  
Valigetta con due manometri + accessori tipo 1

TAMAÑO SIZE	ESCALA (bar) SCALE (bar)	REFERENCIA PART N°	€
320X280X119	0-160; 0-315	CBOX0001	231,43

### Maletín tres manómetros + accesorios tipo 2



Coffre 3 manomètres + accessoires type 2  
Check case 3 manometers + accessories type 2  
Valigetta con tre manometri + accessori tipo 2

TAMAÑO SIZE	ESCALA (bar) SCALE (bar)	REFERENCIA PART N°	€
320x280x119	0-100; 0-250; 0-400	CBOX0002	342,72



2 MANOMETERS 1/4 0-160  
0-315

1 MPR 1/4 C/J  
1 MPR 3/8 C/J  
1 MPR 1/4 NPT  
1 MPR A 10X1  
1 MPD 1/4 BSP  
1 STEEL CAP  
1 MPD 90 1/4 BSP  
1 HOSE ASSEMBLY TL-TL 16X2 1.5 MTS



3 MANOMETERS 0-100  
0-250  
0-400

1 MPR 1/4 C/J  
1 MPR 3/8 C/J  
1 MPR 1/4 NPT  
1 MPR A 10X1  
1 MPD 1/4 BSP  
1 MPD 1/2 BSP  
1 STEEL CAP  
1 MPR PT 1/4 BSP  
1 HOSE ASSEMBLY 1000 mm TL-TL 16X2  
1 HOSE ASSEMBLY 2000 mm TL-TL 16X2

## Medidores de caudal

Débitmètres  
Flow tester  
Indicatori di flusso

Hoses

### Caudalímetro 250 bar tipo 3 - 1/2"



Débitmètre 250 bar type 3-1/2"  
Flow tester type 3-1/2"  
Flussostato 250 bar tipo 3-1/2"

ESCALA (l/min) SCALE (l/min)	REFERENCIA PART N°	€
0-56	WPB3A6HT15	684,83

### Caudalímetro 250 bar tipo 5 - 1 1/2"



Débitmètre 250 bar type 5-1 1/2"  
Flow tester type 5-1 1/2"  
Flussostato 250 bar tipo 5-1 1/2"

ESCALA (l/min) SCALE (l/min)	REFERENCIA PART N°	€
0-550	WPB5A6HY99	2.249,70

Flexible hose fittings

### Caudalímetro 250 bar tipo 4 - 1"



Débitmètre 250 bar type 4-1"  
Flow tester type 4-1"  
Flussostato 250 bar tipo 4-1"

ESCALA (l/min) SCALE (l/min)	REFERENCIA PART N°	€
0-150	WPB4A6HV40	978,90

Stainless steel hoses  
and fittings

### Caudalímetro 400 bar Tipo 57



Débitmètre 400 bar Type 57  
Flow tester 400 bar Type 57  
Flussostato 400 bar Tipo 57

ESCALA (l/min) SCALE (l/min)	REFERENCIA PART N°	€
0-30	FT5758-01	1.198,52
0-60	FT5758-02	1.311,23
0-120	FT5758-03	1.423,93

Low pressure

### Caudalímetro 300 bar Tipo 60



Débitmètre 300 bar Type 60  
Flow tester 300 bar Type 60  
Flussostato 300 bar Tipo 60

ESCALA (l/min) SCALE (l/min)	REFERENCIA PART N°	€
0-200	FT6068-01	2.413,53
0-400	FT6068-03	3.015,54

Air conditioned hoses  
and fittings

### Caudalímetro 400 bar con caja



Débitmètre 400 bar avec boîte  
Flow tester 400 bar with box  
Flussostato 400 bar con cassa

ESCALA (l/min) SCALE (l/min)	REFERENCIA PART N°	€
0-120	FT5594-03	3.128,25
0-180	FT5594-09	3.463,61

Measuring flow

### Foto-tacómetro



Photo-tachymètre  
Photo-tachometer  
Foto-tachimetro

Descripción Description	REFERENCIA PART N°	€
Foto-tacómetro digital	DT2238	422,48

Machines for  
mounting flexibles

► Tomas de presión para circuitos ya existentes

Prises de pression pour circuits | Measuring connectors for assembled installations  
 Presa di pressione per circuiti già esistenti

► **Montaje en tubos con presión SC1** | Montage sur tubes avec pression SC1 | SC1 for mounting on pressurized pipes | Montaggio su tubi in pressione SC1



**Sensor de presión** | Capteur de pression | Pressure sensor | Sensore di pressione

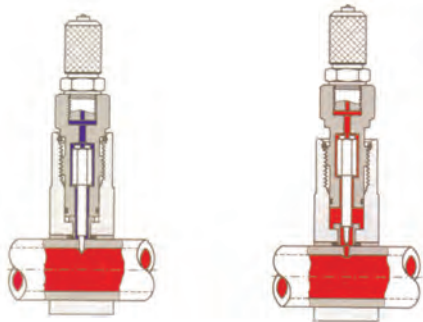

► **Montaje en tubos sin presión SC2** | Montage en tubes sans pression SC2 | SC2 for mounting on non-pressurized pipes | Montaggio su tubi non in pressione SC2



**Sensor de temperatura** | Capteur de température | Temperature sensor | Sensore di temperatura  
**Sensor de presión** | Capteur de pression | Pressure sensor | Sensore di pressione  
**Sensor de caudal** | Capteur de débit | Flow rate sensor | Sensore di portata

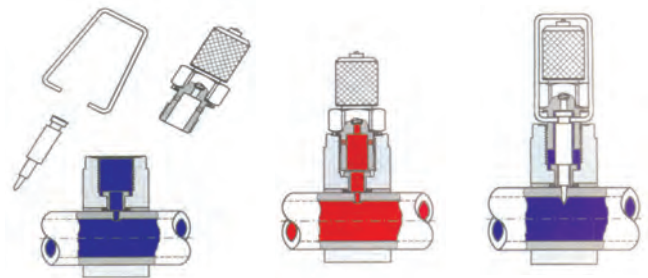

Hoses

Flexible hose fittings

Stainless steel hoses and fittings

Low pressure

Air conditioned hoses and fittings

Measuring flow

Machines for mounting flexibles



## Tomas de presión para circuitos ya existentes

Prises de pression pour circuits | Measuring connectors for assembled installations  
Presa di pressione per circuiti già esistenti

**Toma de manómetro SC1 para instalación en tubos con presión** | Prise de pression SC1 pour tubes à pression | Measuring connector SC1 for mounting on pressurized pipes | Porta manometro SC1 per installazione su tubi pressione



Referencia Référence Part number Codice	Ø Ext. (mm)	Presión máx. Pression max. Max. pressure Pressione max. (Bar)	€
SC1A10	10	630	356,57
SC1A12	12	630	356,57
SC1A14	14	630	356,57
SC1A15	15	630	356,57
SC1A16	16	630	356,57
SC1A18	18	630	356,57
SC1A20	20	630	376,63
SC1A22	22	630	376,63
SC1A25	25	630	376,63
SC1A28	28	630	376,63
SC1A30	30	630	392,23
SC1A35	35	630	392,23
SC1A38	38	630	392,23
SC1A42	42	630	392,23

**Toma de manómetro SC2 para instalación en tubos sin presión** | Prise de pression SC2 pour tubes sans pression | Measuring connector SC2 for mounting on non-pressurized pipes | Porta manometro SC2 per installazione su tubi senza pressione



Referencia Référence Part number Codice	Ø Ext. (mm)	Presión máx. Pression max. Max. pressure Pressione max. (Bar)	€
SC2A10	10	630	218,40
SC2A12	12	630	218,40
SC2A14	14	630	218,40
SC2A15	15	630	218,40
SC2A16	16	630	218,40
SC2A18	18	630	218,40
SC2A20	20	630	247,37
SC2A22	22	630	247,37
SC2A25	25	630	247,37
SC2A28	28	630	247,37
SC2A30	30	630	276,34
SC2A35	35	630	276,34
SC2A38	38	630	276,34
SC2A42	42	630	276,34

### Sensores | Capteurs | Sensors | Sensori

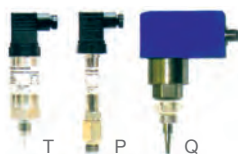

Referencia Référence Part number Codice	Descripción Description Description Descrizione	Presión máx. Pression max. Max. pressure Pressione max. (Bar)	€
TS1A1203/8	Sensor temperatura para SC2 Capteur de temperature pour SC2 Temperature sensor suitable for SC2 Sensore di temperatura	630	797,83
DS1A4001/4	Sensor presión para SC1 Capteur de temperature pour SC1 Pressure sensor suitable for SC1 Sensore di pressione per SC1	630	842,40
DS1A4003/8	Sensor presión para SC2 Capteur de pression pour SC2 Pressure sensor suitable for SC2 Sensore di pressione per SC2	630	842,40
QS2B0083/8	Sensor de caudal para SC2 * <i>Calibración, consultar</i> Capteur de flux pour SC2 * <i>Calibrage, consulter</i> Flow rate sensor suitable for SCS * <i>Calibration service, on request</i> Sensore di portata per SC2 * <i>Regolazione a richiesta</i>	630	1.938,86

### Maletín servicios hidráulicos | Coffret pour services hydrauliques | Hydraulic services suitcase | Valigetta servizi idraulici



Referencia Référence Part number Codice	Contenido Contenu Contents Contenuto	€
MSC01	8 x SC1	2.861,49
MSC02	8 x SC2	1.880,91
MSC03	3 x SC1 + 3 x SC2 2 x sensores DS/TS	3.342,86

**Kit de medida con indicador digital (2 inputs analógicos) | Kit de mesure avec indicateur numérique (2 intrants analogique) | Measurement kit with digital gauge | Kit di misurazione con indicatore digitale (2 entrate analogiche)**



Referencia Référence Part number Codice	€
FM1B	2.450

Gama de productos. Para más información soliciten nuestros catálogos generales o visiten nuestra página web  
Gamme de produits. Pour plus d'information, nous vous prions de nous demander nos catalogues generaux ou visiter notre web-site  
Products range. For any further information, please, ask for our general catalogues or visit our web-site  
Gamma di Prodotti. Per ulteriori información di ricuidete il nostri cataloghi o visitate la Nostra pagina web

## COMPONENTES / COMPOSANTS / COMPONENTS / COMPONENTI

PROGRAMA  
HIDRÁULICO  
HYDRAULIC PROGRAM



LÍNEA / RANGE



SERVICIO HIDRÁULICO  
DISTRIBUCIÓN OFICIAL  
HYDRAULIC SERVICE  
OFFICIAL DISTRIBUTION

*Roquet* 

 **SAUER**  
**DANFOSS**

 **JUNTAS BESMA, S.A.**



7

# Máquinas para flexibles. Prensas manuales

Machines pour flexibles. Presses manuelles | Machines for flexibles. Manual crimping machines | Macchine per tubi flessibili. Presse manuale

Hoses

Flexible hose fittings

Stainless steel hoses and fittings

Low pressure

Air conditioned hoses and fittings

Measuring flow

Machines for mounting flexibles

V001040



PHM2 12 (3/4" R2) - PHM2 16 (1" R2)

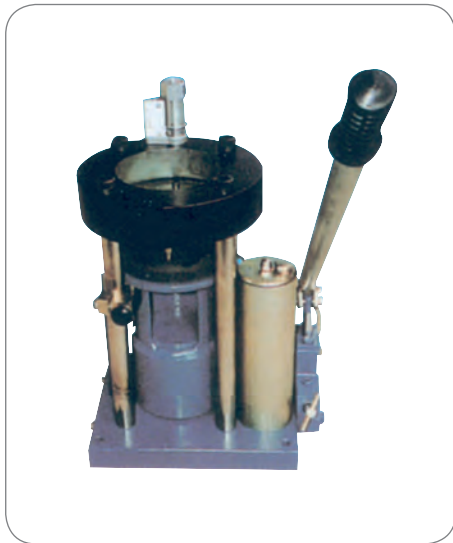

PEA 16 (1" R2)



SM2



90 t   +22 mm   75 mm

S2P



90 t   +22 mm   75 mm

PM18



80 t   +20 mm   59 mm

# Máquinas para flexibles. Prensas horizontales sobre mesa

Machines pour flexibles. Presses horizontales avec support | Machines for flexibles. Horizontal crimping machines with support | Macchine per tubi flessibili. Presse orizzontale sul tavolo

Hoses

Flexible hose fittings

Stainless steel hoses and fittings

Low pressure

Air conditioned hoses and fittings

Measuring flow

Machines for mounting flexibles

SE 25 (12 4SP)



120 t +18 mm 98 mm

PE 28 1" 1/4 4 SP)



137 t +28 mm 100 mm

PE 32 1" 1/4 6 SP)



207 t +38 mm 118 mm

PE 38 (2" 4 SP)



204 t +38 mm 118 mm

PE 58 (2" 6 SP)



305 t +54 mm 180 mm

SPEBDEG



HM 220



140 t +35 mm 105 mm

PES 32 (1" 1/4 4 SP)



140 t +45 mm 124 mm

PES 50 (2" 6 SP)T



280 t +70 mm 147 mm

# Máquinas para flexibles. Prensas horizontales

Machines pour flexibles. Presses horizontales | Machines for flexibles. Horizontal crimping machines | Macchine per tubi flessibili. Presse orizzontale

Hoses

Flexible hose fittings

Stainless steel hoses and fittings

Low pressure

Air conditioned hoses and fittings

Measuring flow

Machines for mounting flexibles

▶ PES 125 (3" 6 SP)



400 t +85 mm 212 mm

▶ PESO 320 (6")



320 t +55 mm 260 mm

▶ PE 280 (6")



400 t +50 mm 285 mm

▶ Taller móvil para montaje de latiguillos | Atelier mobile pour montage des flexibles | Mobile workshop for hose assembly | Officina mobile per raccordatura tubi



▶ PE 28 / PE 38



▶ CHMT 20



▶ HST 50



▶ Bateria | Batterie | Battery | Batteria



325 x 165 x 238 / 26,5 kg

# ▶ Máquinas para flexibles. Cortadoras

Machines pour flexibles. Tronçonneuse | Machines for flexibles. Cutting machines | Macchine per tubi flessibili. Taglierine

▶ **CHMT-20**



▶ **CHM4-32D (2")**



▶ **TS 50 (2" 6SP)**



▶ **MN500SW (hasta 1" 1/2)**



▶ **MN450 (hasta 3/4")**



Hoses

Flexible hose fittings

Stainless steel hoses and fittings

Low pressure

Air conditioned hoses and fittings

Measuring flow

Machines for mounting flexibles



## Máquinas para flexibles. Otras máquinas

Machines pour flexibles. D'autres machines | Machines for flexibles. Other machines | Macchine per tubi flessibili. Altre macchine

Hoses

Flexible hose fittings

Stainless steel hoses and fittings

Low pressure

Air conditioned hoses and fittings

Measuring flow

Machines for mounting flexibles

- ▶ **Banco de pruebas BE 1500 / BE 2500** | Banque d'essais BE 1500 / BE 2500  
Testing bank BE 1500 / BE 2500 | Banco de prova BE 1500 / BE 2500



Opcional | Optionnel |  
Optional | Opzionale

- ▶ **Marcadora MMJ 50** | Machine de marquage  
Marking machine | Marcatrice



- ▶ **INSERT 02 P**



- ▶ **PEP 158**



102 t   +28 mm   156 mm

- ▶ **Banco limpieza RG1** | Banque de nettoyage  
Cleaning bank | Banca per la pulizia



- ▶ **Banco limpieza portátil RG2**  
Banque de nettoyage portable  
Portable cleaning bank  
Banca per la pulizia portabile



- ▶ **Mesa soldadura**  
Support à soudage  
Welding machine  
Tavolo di saldatura



Ø int. max. 165 mm

# ▶ Máquinas para flexibles. Accesorios para prensas

Machines pour flexibles. Accessoires pour machines à sertir | Machines for flexible. Accessories for crimping machines | Macchine per tubi flessibili. Accessori per presse

## ▶ EG



## ▶ CME



## ▶ Garras especiales | Mors spécial Special gags | Morssetti speciale

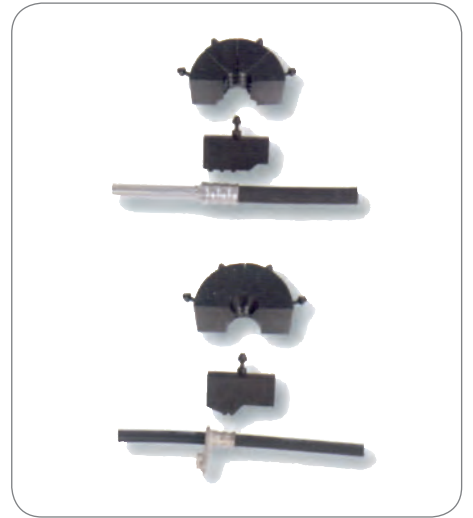

## ▶ Computer



## ▶ BSA

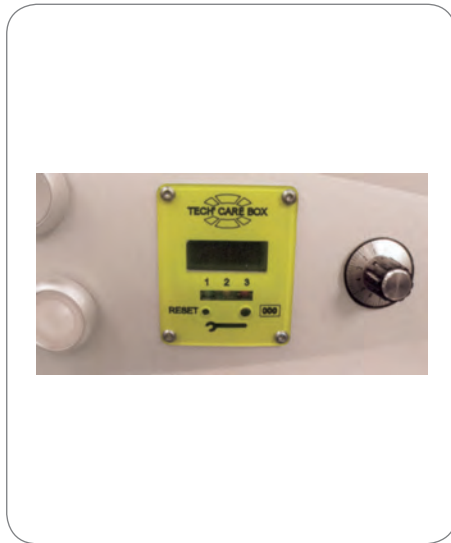

## ▶ Tope trasero | Butée arrière Back stop | Fermata posteriore



## ▶ Portarrollos | Porte-Rouleaux Roll-Holder | Portarotoli

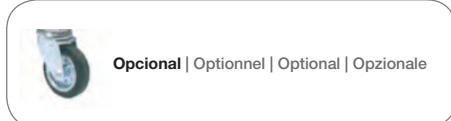

Opcional | Optionnel | Optional | Opzionale

Hoses

Flexible hose fittings

Stainless steel hoses and fittings

Low pressure

Air conditioned hoses and fittings

Measuring flow

Machines for mounting flexibles

# Peladoras

Denudeuses | Skive machines | Spellatubi

Hoses

Flexible hose fittings

Stainless steel hoses and fittings

Low pressure

Air conditioned hoses and fittings

Measuring flow

Machines for mounting flexibles



## PBC-32

**Peladora con mueble hasta 2". Opción estándar** | Skiving machine up to 2", standard option



## PBCM-32

**Peladora con mueble. Opción MS** | Skiving machine, MS option



Capacidad pelado exterior   External skiving	2"
Capacidad pelado interior   Internal skiving	2"
R.P.M.   R.P.M.	300
Alimentación neumática   Pneumatic input	Máx. 7 Bar
Potencia motor   Engine power	0,75 KW

## Opcional | Optionnel | Optional | Opzionale

**Mordaza neumática** | Pneumatic clamp



**Portaherramientas** | Tool holder



**Mueble portaherramientas** | Tool holder cabinet



## PB-32

**Peladora sin mueble hasta 2"** | Skiving machine up to 2"



Capacidad pelado exterior   External skiving	2"
Capacidad pelado interior   Internal skiving	2"
R.P.M.   R.P.M.	300
Potencia motor   Engine power	0,75 KW

**Portaherramientas (opcional)** | Tool holder (optional)



**Otras máquinas: consultar** | Autres machines, sur demande | Other machines, on request | Altre macchine, sur richiesta

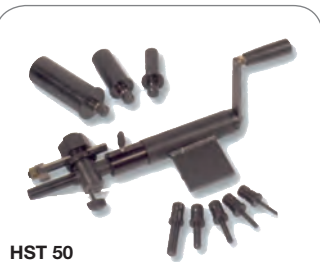

HST 50



PBCMU-32

# Tubo r gido

Conductions rigides  
Pipe conductions  
Tubo r gido



## Tubería rígida

Tube rigide  
Pipe  
Tubo rígido

1

## Racores DIN 2353

Raccords à bague DIN 2353  
DIN 2353 Pipe Fittings  
Raccordi ad anello DIN 2353

2

## Racores para tubo gas

Raccords tube gaz  
Gas tube fittings  
Raccordi per tubo gas

3

## Racores JIC 37°

Raccords JIC 37°  
JIC 37° fittings  
Raccordi JIC 37°

4

## Bridas SAE

Brides de fixation SAE  
SAE Flanges  
Flange SAE

5

## Abrazaderas

Colliers  
Clamps  
Collari fissatubo

6

## Máquinas para procesar el tubo rígido

Machines pour travailler le tube rigide  
Machines for processing rigid pipes  
Macchine per il trattamento del tubo rígido

7

# Tubería rígida

Tube rigide

Pipe

Tubo rigido

# 1

Tubo rígido EN 10305-4 (métrico)

144

[Tube rigide EN 10305-4 \(Métrique\)](#) | [Pipe EN 10305-4 \(Metric\)](#) | [Tubo rígido EN 10305-4 \(métrico\)](#)

# Tubo rígido EN 10305-4 (métrico)

Tube rigide EN 10305-4 (Métrique) | Pipe EN 10305-4 (Metric) | Tubo rígido EN 10305-4 (métrico)

Pipe

**Tubo rígido EN 10305-4 (métrico)** | Tube rigide EN 10305-4 (Métrique) | Pipe EN 10305-4 (Metric) | Tubo rígido EN 10305-4 (métrico)



TH0



THZ

DIN 2353 Pipe Fittings

Gas tube fittings

JIC 37° fittings

SAE Flanges

Clamps

Machines for processing rigid pipes



## Tubo rígido EN 10305-4 (métrico)

Tube rigide EN 10305-4 (Métrique)

Pipe EN 10305-4 (Metric)

Tubo rígido EN 10305-4 (métrico)

### Tubo ST-35 (standard)



Tube rigide ST-35 (standard)

Pipe ST-35 (standard)

Tubo rígido ST-35 (standard)

Ø ext	Ø in	Pr.Tr. (bar) WP (bar)	Kg/m	REFERENCIA PART N°	€
6	4	325	0,123	TH0060100	4,29
8	6	225	0,172	TH0080100	5,06
8	5	375	0,24	TH0080150	5,35
10	7	275	0,314	TH0100150	6,00
12	9	225	0,388	TH0120150	6,71
14	10	275	0,591	TH0140200	9,59
15	12	175	0,499	TH0150150	7,88
16	12	225	0,69	TH0160200	10,41
16	11	300	0,832	TH0160250	12,65
18	14	200	0,789	TH0180200	10,65
20	14	275	1,257	TH0200300	16,41
22	18	150	0,986	TH0220200	13,35
25	19	225	1,627	TH0250300	20,17
28	24	125	1,282	TH0280200	17,64
30	24	175	1,997	TH0300300	24,05
35	29	150	2,367	TH0350300	29,00
38	28	250	4,068	TH0380500	48,64
42	36	125	2,885	TH0420300	35,35

### Tubo ST-37.2 (Cromo III)



Tube rigide ST-37.2 (Chrome III)

Pipe ST-37.2 (Chromium III)

Tubo rígido ST-37.2 (Cromo III)

Ø ext	Ø in	Pr.Tr. (bar) WP (bar)	Kg/m	REFERENCIA PART N°	€
6	4	325	0,123	THZ060100	5,18
8	6	225	0,172	THZ080100	6,06
8	5	375	0,24	THZ080150	6,29
10	7	275	0,314	THZ100150	7,23
12	9	225	0,388	THZ120150	8,00
14	10	275	0,591	THZ140200	11,06
15	12	175	0,499	THZ150150	9,59
15	11	250	0,641	THZ150200	11,88
16	12	225	0,69	THZ160200	12,23
18	15	150	0,61	THZ180150	10,59
18	14	200	0,789	THZ180200	12,59
20	14	275	1,257	THZ200300	18,41
22	18	150	0,986	THZ220200	15,64
25	19	225	1,627	THZ250300	23,23
28	24	125	1,282	THZ280200	21,11
30	22	250	2,564	THZ300400	35,58
35	29	150	2,367	THZ350300	33,70

**Maleabilidad: Muy buena** | Malléabilité: Très bonne | Malleability: Very good | Malleabilità: Molto buona

**Soldadilidad: Muy buena** | Soudure: Très bonne | Welding: Very good | Soldabilità: Molto buona

**Resistencia a la tracción: 35/45 kg. mm<sup>2</sup>** | Résistance à la traction: 35/45 Kg. mm<sup>2</sup> | Resistant to traction: 35/45 Kg. mm<sup>2</sup> | Resistenza alla trazione: 35/45 Kg. mm<sup>2</sup>

**Alargamiento: Mín. 25%** | Prolongement: Min. 25% | Prolongation: Min. 25% | Allungamento: Min. 25%

**Análisis** | Analyse | Analysis | Analisi:

- **Carbono: Máx. 0,18%** | Carbone: Max. 0,18% | Carbon: Max. 0,18% | Carbonio: Max. 0,18%
- **Fósforo: Máx. 0,05%** | Phosphore: Máx. 0,05% | Phosphorus: Max. 0,05% | Fosforo: Max. 0,05%
- **Azufre: Máx. 0,05%** | Soufre: Max. 0,05% | Sulphur: Max. 0,05% | Zolfo: Max 0,05%

**Tubos de precisión en acero sin soldadura, calibrados interior y exteriormente por estirado en frío, de acuerdo con la norma EN10305-4 y en la calidad de acero St. 35. Suministrados en acabado NBK (normalizado en horno de atmósfera controlada), probados unitariamente a presión hidráulica, o bien, por corriente de Foucault y en largos comerciales de 3 a 7 m.** | Tubes de précision de circuit de soudure, en acier doux, alésage en l'intérieur et l'extérieur par être étirés à froid suivant norme EN10305-4 en la qualité d'acier St 35. Tube recuit en atmosphère neutre, parfait NBK. Tous les tubes subissent un contrôle systématique non destructif au courant de Foucault et un contrôle visuel sur table de l'aspect extérieur du tube. La commercialisation des tubes est en longueurs de 3 à 7 mètres. | Precision pipes in carbon steel without welding, internal and external calibration by cold stretch, according to norm EN10305-4 and in carbon quality ST. 35. Finished in NBK (normalized in controlled atmosphere furnace). Tested to hydraulic pressure one by one, or, by Foucault current and in commercial lengths from 3 to 7 M. | Tubo di precisione in acciaio senza saldatura, calibrato internamente e esternamente, trafilato a freddo secondo normativa EN10305-4 e qualità acciaio ST-35. Ricottura in NBK (normalizzato a forno in atmosfera controllata). Testato alla pressione idraulica al 100%, a vista ed a corrente di Foucault, in verge commerciali da 3 a 7 mt.

**(1) Presión de trabajo: Presión máxima de utilización recomendada, teniendo en cuenta que la presión de estallido es aproximadamente cuatro veces la presión indicada en la tabla.** | (1) Pression de travail: C'est la pression maximum de travail conseillée, en prenant en compte le fait que la pression d'éclatement c'est 4 fois la pression indiquée au tableau | (1) Working pressure: Suggested working pressure, taking into account that burst pressure is 4 times the indicated working pressure in the table | (1) Pressione di lavoro: pressione massima di utilizzo raccomandada, tenendo in considerazione che la pressione di scoppio è circa quattro volte la pressione indicata nella tabella.

# Racores DIN 2353

Raccords à bague DIN 2353

**DIN 2353 Pipe Fittings**

Raccordi ad anello DIN 2353



Racores DIN 2353	150
Raccords à bague DIN 2353   DIN 2353 Pipe fittings   Raccordi ad anello DIN 2353	
Racores DIN 2353 sin tuerca y anillo CrIII	152
Raccords DIN 2353 sans écrou et bague CrIII   DIN 2353 Pipe fittings without nut and ring CrIII   Raccordi DIN 2353 senza dado e anello CrIII	

# Racores DIN 2353

Raccords à bague DIN 2353 | DIN 2353 Pipe fittings | Raccordi DIN 2353

Pipe

DIN 2353 Pipe Fittings

Gas tube fittings

JIC 37° fittings

SAE Flanges

Clamps

Machines for processing rigid pipes

**Instrucciones de montaje del racor DIN 2353 sobre el tubo rígido (se recomienda el uso de herramientas de premontaje)**  
 | Mode d'emploi de montage du raccord DIN 2353 sur le tube rigide (L'utilisation des outils de pré-montage est conseillée) |  
**Assembly of the pipe fittings DIN 2353 in the rigid pipe (It is recommended to use pre-assembly tools)** | **Assemblaggio del**  
**raccordo ad anello DIN 2353 nel tubo rigido (è si consiglia l'uso degli utensili di premontaggio)**

**A. Preparación del tubo | Préparation du tube | Preparation of the tube | Preparazione del tubo**

**Altura mínima (H)**  
 | Hauteur minimale (H) | Minimum Height (H) | Minima lunghezza diritta (H)

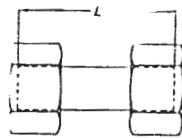
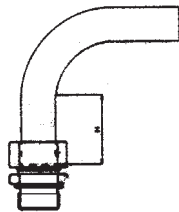

**Longitud mínima (L)**  
 | Longueur minimale (L) | Minimum Length (L) | Minima lunghezza (L)

<b>Series</b>	LL	L	S
<b>Ø ext. tube</b>	4-5-6-8	6-8-10-12-15-18-22-28-35-42	6-8-10-12-14-16-20-25-30-38
<b>H min</b>	LL 24-25-25-26	L 31-31-33-33-36-38-42-42-48-48	S 35-35-37-37-43-43-50-54-58-65
<b>L min</b>	LL 30-32-32-33	L 39-39-42-42-45-48-53-53-60-60	S 44-44-47-47-54-54-63-68-73-82



**Cortar el tubo a escuadra y eliminar rebabas** | Couper le tube à angle droit sans coupes imprécises | Rectangularly saw off the pipe and slightly debug the tube ends inside and outside | Tagliare il tubo ad angolo retto ed eliminare i residui metallici

**B. Lubricar adecuadamente | Lubrifier convenablement | Lubricate suitably | Lubrificare convenientemente**

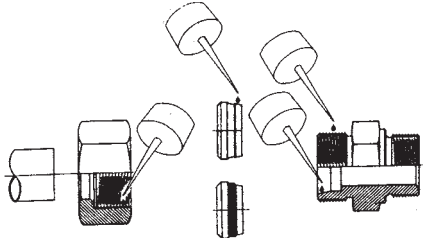

**C. Montaje | Montage | Assembly | Montaggio**

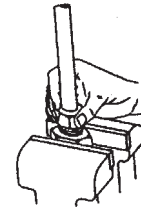

**D. Apriete | Blockage | Blocking | Bloccaggio**

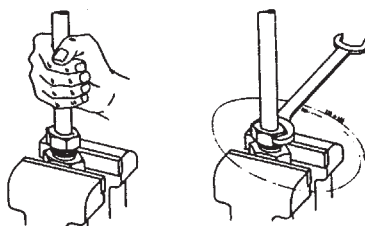

**E. Control | Control | Control | Controllo**



**F. Montaje final | Montage final | Final assembly | Montaggio finale**

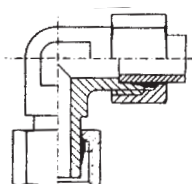

**G. Montajes posteriores | Montages posterieurs | Later assemblies | Montaggio successivo**

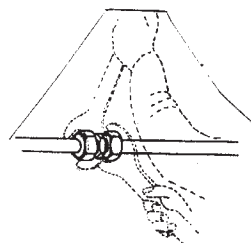

**Nota sobre piezas premontadas (CTA): El montaje final se realizará apretando la tuerca al menos ½ vuelta más desde el punto a partir del cual se empieza a hacer más fuerza** | Pour les pièces pré-assemblées (CTA), le montage final doit être fait en tournant au moins un ½ tour à partir du point où une résistance plus importante est appréciée. | For preassembled fittings (CTA), the final assembly is made tightening the nut at least ½ turn beyond the point of a noticeable increase in force. | Per tutti i raccordi premontati (CTA), il premontaggio avviene con apposite attrezzature. Il montaggio finale si realizza serrando almeno ½ giro oltre il punto in cui si inizia ad avvertire chiaramente l'aumento della resistenza.

## Una solución eficaz, económica y sencilla para prevenir el goteo en las conducciones de tubo rígido

Une solution efficace, économique et simple pour prévenir les fuites dans les émbouts pour tube rigide | An effective, cheap and simple solution to prevent the leak in pipe fittings | Una soluzione efficace, economica e semplice per prevenire perdite dai raccordi per tubo rigido

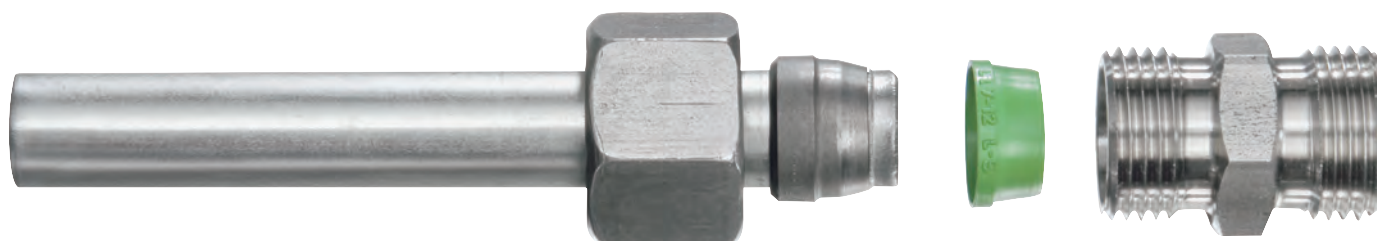

- Óptima prevención de fugas
- Larga durabilidad
- Fácil montaje, revisión y sustitución
- Protección antivibraciones
- Excelente resistencia a altas temperaturas y fluidos agresivos

- Bonne prévention de fuites
- Longue durée
- Facile montage, inspection et substitution
- Protection Anti-vibration
- Excellente résistance aux hautes températures et fluides agressifs

- Good leakage prevention
- Long shelf life
- Easy assembly, inspection, replacement
- Anti-vibration and unscrewing protection
- Excellent resistance to high temperatures and aggressive fluids

- Buona prevenzione delle perdite
- Lunga durata
- Facile montaggio, ispezione e sostituzione
- Antivibrazione e protezione allo svitamento
- Eccellente resistenza alle alte temperature e fluidi aggressivi

### Información técnica | Information technique | Technical data | Informazione tecnica

Material   Matériel   Material   Materiale	Vitón verde   Viton vert 70/80 sh   Green viton 70/80 sh   Viton verde
Temperatura   Temperature   Temperature   Temperatura	-35°C + 100°C
Durabilidad   Durée   Self life   Durata	5 años   5 an   5 year   5 anni

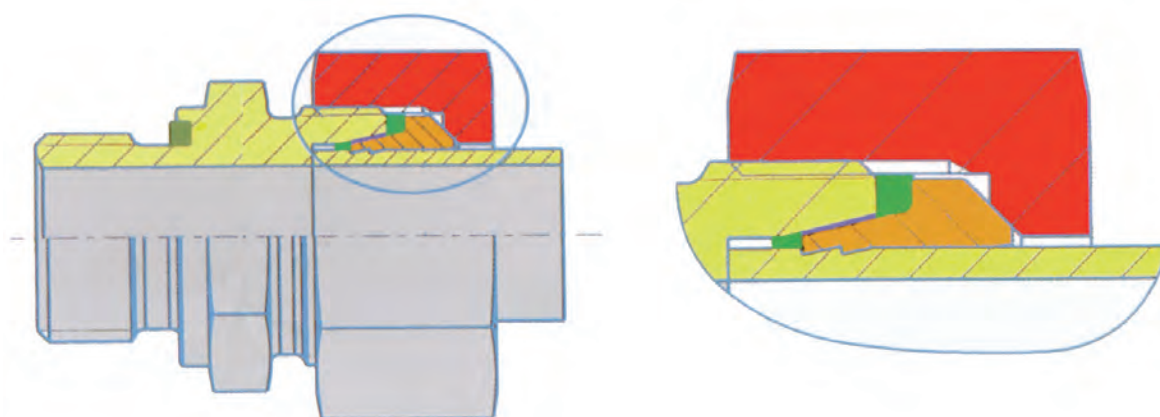

## Racores DIN 2353

Raccords à bague DIN 2353 | DIN 2353 Pipe fittings | Raccordi ad anello DIN 2353

Pipe

### Tuercas y anillos | Écrou et bagues | Nuts and cutting rings | Dadi e anelli

155

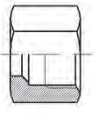

ML/MS



ACL/ACS



VA

### Uniones tubo-tubo | Unions doubles | Straight couplings | Raccordi intermedi

156

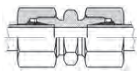

DL/DS

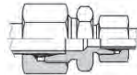

DL/DS

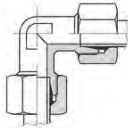

EL/ES

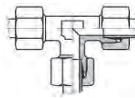

TL/TS



KVL/KVS

### Uniones rectas tubo-rosca | Unions simples mâle | Straight male stud couplings | Raccordi di estremità diritti

158



AKL/AKS BSPT



AL/AS BSP

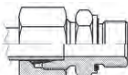

AL/AS WD BSP



AKL/AKS NPT



AL/AS UNF



AL/AS METRICA



AL/AS WD METRICA

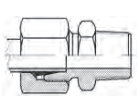

AKLL METRICA

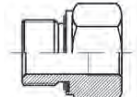

RI-R WD

### Codos tubo-rosca | Coudes mâle gaz | Male stud elbows | Raccordi di estremità a 90°

162

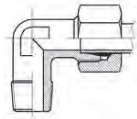

CKL/CKS BSPT

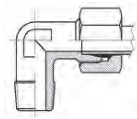

CKL/CKS METRICA

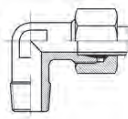

CKL/CKS NPT

### Uniones Métricas | Unions Métriques | Metric unions | Raccordi di riduzione (Metrici)

163

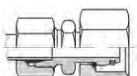

KORL-TLM

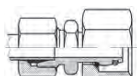

KORS-TLM

### Racores regulables | Raccords réglables | Adjustable stud couplings | Raccordi orientabili

164

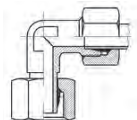

EEL/EES-CTA

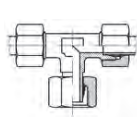

TEL/ES-CTA

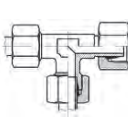

LEL/LES-CTA

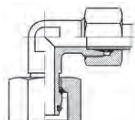

EEL/EES-TLM

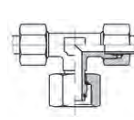

TEL/ES-TLM

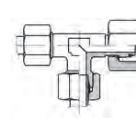

LEL/LES-TLM

### Tubo roscado (hembra giratoria) | Tube fileté | Adjustable straight stud | Raccordi di estremità per combinazioni

165

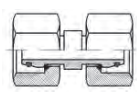

ATL/ATS

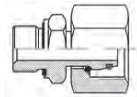

RAL/RAS-TLM WD METRICA

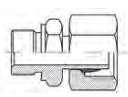

RAL/RAS-CTA WD METRICA

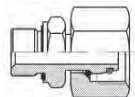

RAL/RAS-TLM WD BSP

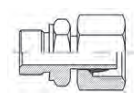

RAL/RAS-CTA WD BSP

Gas tube fittings

JIC 37° fittings

SAE Flanges

Clamps

Machines for processing rigid pipes

► **Soldables** | Raccords à souder | Welding couplings | Raccordi a saldare 167

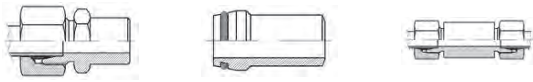

ASL/ASS

ORIL/ORIS

ESVL/ESVS

► **Pasatabiques** | Passe cloison | Bulkhead | Raccordi di attraversamento 168

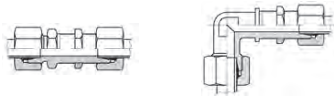

SVL/SVS

USVL/USVS

► **Racor recto hembra** | Raccord droit femelle | Straight female coupling | Raccordi diritti con estremità femmina 169

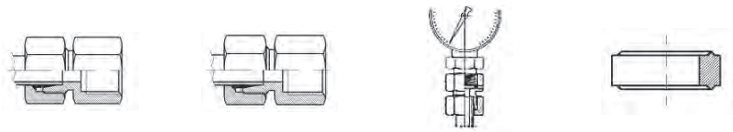

GAIL/GAIS BSP

BAIL/GAIS METRICA

MAVL/MAVS BSP

AM

► **Orientables** | Banjos | Banjos | Raccordi orientabili a occhio 170

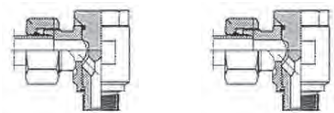

WSVL/WSVS BSP

WSVL/WSVS METRICA

► **Tapones** | Bouchons | Plugs | Tappi 171

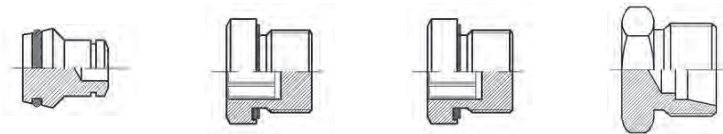

BUTZEN L/S

STOPFEN BSP

STOPFEN METRICA

STA TML

► **Válvulas antirretorno** | Clapet antiretour pour tube | Non-return valves | Valvole di ritegno 172

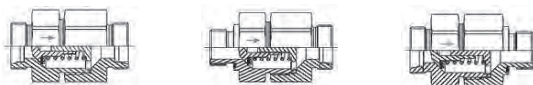

RHDL/RHDS BIDIRECCIONAL

RHVL/RHVS <=>

RHZL/RHVS =>

## Racores DIN 2353 sin tuerca y anillo CrIII

Raccords DIN 2353 sans écrou et bague CrIII | DIN 2353 Pipe fittings without nut and ring CrIII | Raccordi DIN 2353 senza dado e anello CrIII

### Tuercas y anillos | Écrou et bagues | Nuts and cutting rings | Dadi e anelli

174

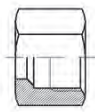

B ML/MS



B ACL/ACS

### Uniones tubo-tubo | Unions doubles | Straight couplings | Raccordi Intermedi

174

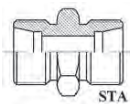

B STA DL/DS

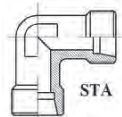

B STA EL/ES

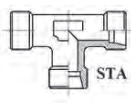

B STA TL/TS



B STA DL/DS

### Codos tubo-roscas | Coudes mâle gaz | Male stud elbows | Raccordi di estremità a 90°

175

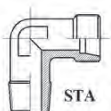
B STA CKL/CKS  
BSPT

### Uniones rectas tubo-roscas | Unions simples mâle | Straight male stud couplings | Raccordi di estremità diritti

176

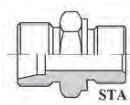

B STA AL/AS BSP

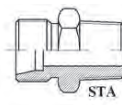
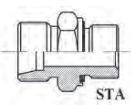
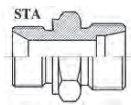
B STA AKL/AKS  
BSPTB STA AL/AS WD  
BSPB STA AL RC/AS  
RC BSP

### Uniones Métricas | Unions Métriques | Metric unions | Raccordi di riduzione (Metrici)

177

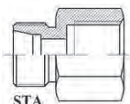
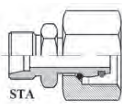
B STA GAIL/GAIS  
BSP

B STA KORL-TLM

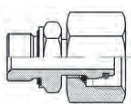
B RAL/RAS-TLM  
WD BSP

### Racores regulable | Raccords réglables | Adjustable stud couplings | Raccordi orientabili

178

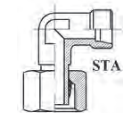
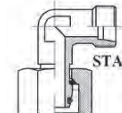
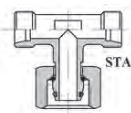
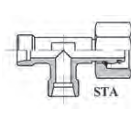
B STA EEL/EES-  
CTAB STA EEL/EES-  
TLMB STA TEL/TES-  
TLMB STA LEL/LES-  
TLM

### Soldables | Raccords à souder | Welding couplings | Raccordi a saldare

179

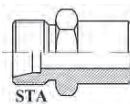

B STA ASL/ASS

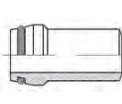

B ORIS



► **Pasatabiques** | Passe cloison | Bulkhead | Raccordi attraversamento

179

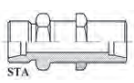

B STA SVL/SVS

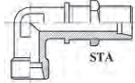

B STA USVL/  
USVS

► **Orientables** | Banjos | Banjos | Raccordi orientabili a occhio

180

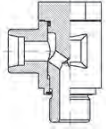

B STA WSVL/  
WSVS BSP

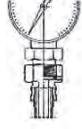

B STA MAVL/  
MAVS BSP

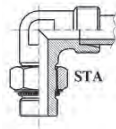

STA WEE

► **Tapones** | Bouchons | Plugs | Tappi

180

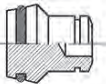

B BUTZEN L/S

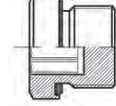

B STOPFEN BSP

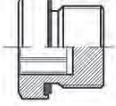

B STOPFEN  
METRICA

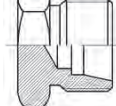

B STA TML

# Nuevo tratamiento superficial: zincado ecológico Zn/Ni

New surface treatment: ecological Zn/Ni coating  
 Nouveau traitement de surface: passivation écologique Zn/Ni  
 Nuovo trattamento superficiale: zincatura ecologica Zn/Ni

- Solución ecológica sin Cromo
- Color gris mate
- Super resistente a la corrosión
- No se alteran las propiedades mecánicas de las piezas

- Ecological Chromium-free solution
- Matt grey color
- Extra resistance to corrosion
- Tightening torque value unchanged

- Solution écologique sans Chrome
- Couleur gris mat
- Très résistant à la corrosion
- Les propriétés mécaniques des pièces ne sont pas modifiées

- Soluzione ecologica senza Cromo
- Colore grigio opaco
- Super resistenza alla corrosione
- Non viene alterata la proprietà meccanica degli articoli

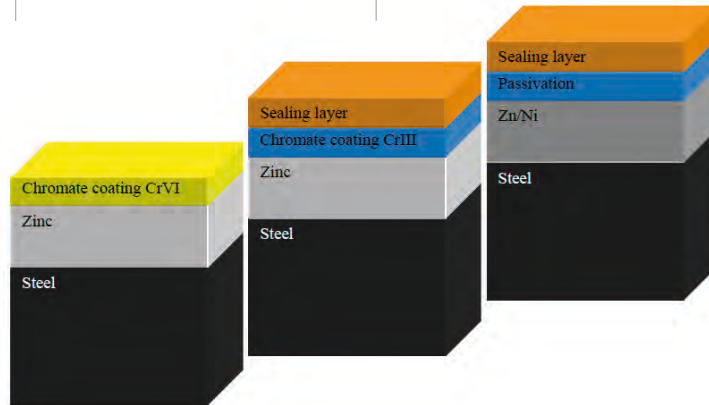

## Ensayos en niebla salina

- artículos no prensados: Zn/Ni: > 700 horas
- artículos prensados: Zn/Ni: > 350 horas

## Salt spray results

- non swaged parts: Zn/Ni: > 700 hours
- swaged parts: Zn/Ni: > 350 hours

## Essais brouillard salin

- articles non sertis: Zn/Ni: > 700 heures
- articles sertis: Zn/Ni: > 350 heures

## Prova in nebbia salina

- articoli non pressati: Zn/Ni: > 700 ore
- articoli pressati: Zn/Ni: > 350 ore



Este nuevo tratamiento solo está disponible en Racores para tubería flexible y Racores DIN 2353.  
 This new treatment is only available for flexible hose fittings and DIN 2353 pipe fittings.  
 Ce nouveau traitement est disponible uniquement pour les embouts de flexibles et les raccords DIN 2353.  
 Questo nuovo trattamento è disponibile solo nei raccordi per tubo flessibile e Raccordi DIN 2353.

# Racores DIN 2353

Raccords à bague DIN 2353  
DIN 2353 Pipe fittings  
Raccordi ad anello DIN 2353

## Tuerca Métrica DIN 3870



Écrou Métrique DIN 3870  
Nuts DIN 3870  
Dadi Metrici DIN 3870

TUBO PIPE	SERIE	ROSCA THREAD	REFERENCIA PART N°	€
4	LL	M8x1	MLL 4 M 8X1	0,29
6	LL	M10x1	MLL 6 M 10X1	0,30
8	LL	M12x1	MLL 8 M 12X1	0,32
6	L	M12x1,5	ML 6 M 12X1.5	0,31
8	L	M14x1,5	ML 8 M 14X1.5	0,38
10	L	M16x1,5	ML 10 M 16X1.5	0,44
12	L	M18x1,5	ML 12 M 18X1.5	0,58
15	L	M22x1,5	ML 15 M 22X1.5	0,95
18	L	M26x1,5	ML 18 M 26X1.5	1,38
22	L	M30x2	ML 22 M 30X2	2,03
28	L	M36x2	ML 28 M 36X2	3,66
35	L	M45x2	ML 35 M 45X2	4,67
42	L	M52x2	ML 42 M 52X2	7,21
6	S	M14x1,5	MS 6 M 14X1.5	0,42
8	S	M16x1,5	MS 8 M 16X1.5	0,50
10	S	M18x1,5	MS 10 M 18X1.5	0,64
12	S	M20x1,5	MS 12 M 20X1.5	0,76
14	S	M22x1,5	MS 14 M 22X1.5	1,08
16	S	M24x1,5	MS 16 M 24X1.5	1,43
20	S	M30x2	MS 20 M 30X2	2,41
25	S	M36x2	MS 25 M 36X2	4,88
30	S	M42x2	MS 30 M 42X2	6,22
38	S	M52x2	MS 38 M 52X2	8,67

## Anillos de corte DIN 3861



Bague Métrique DIN 3861  
Cutting rings DIN 3861  
Anelli DIN 3861

TUBO PIPE	SERIE	REFERENCIA PART N°	€
4	LL	ACLL 4	0,37
6	LL	ACLL 6	0,37
8	LL	ACLL 8	0,37
6	L/S	ACL 6	0,33
8	L/S	ACL 8	0,35
10	L/S	ACL 10	0,41
12	L/S	ACL 12	0,44
15	L	ACL 15	0,51
18	L	ACL 18	0,74
22	L	ACL 22	0,89
28	L	ACL 28	1,25
35	L	ACL 35	2,16
42	L	ACL 42	2,66
14	S	ACS 14	0,82
16	S	ACS 16	0,81
20	S	ACS 20	1,04
25	S	ACS 25	1,30
30	S	ACS 30	1,64
38	S	ACS 38	2,24

## Anillo vitón antifuga



Joint viton anti-fouet  
Vitón seal non-leak  
Anello viton anti-fuga

TUBO PIPE	SERIE	REFERENCIA PART N°	€
6	L/S	VA006L	1,12
8	L/S	VA008L	1,18
10	L/S	VA010L	1,23
12	L/S	VA012L	1,34
15	L	VA015L	1,75
18	L	VA018L	1,80
22	L	VA022L	2,01
28	L	VA028L	2,77
35	L	VA035L	4,38
42	L	VA042L	5,27
14	S	VA014S	1,45
16	S	VA016S	1,76
20	S	VA020S	1,94
25	S	VA025S	2,63
30	S	VA030S	4,02
38	S	VA038S	5,19

Por razones logísticas y de producción, estos productos se suministrarán según disponibilidad (Zn/Ni; CrIII; CrVI). Las referencias más estándar (equivalentes a la serie B, ver págs. (174-181), se suministrarán habitualmente en Zn/Ni. / Pour des raisons logistiques et de fabrication, les produits (Zn/Ni; CrIII; CrVI) seront fournis selon disponibilité. Les références standard, équivalentes à la série B, voir pages (174-181), seront fournies normalement en Zn/Ni. / For logistics and manufacturing reasons, products (Zn/Ni; CrIII; CrVI) will be supplied upon availability. Standard references, equivalent to B series, see pages (174-181), will, usually, be supplied in Zn/Ni. / Per ragioni di logistica e di produzione, questi articoli saranno forniti secondo la disponibilità (Zn/Ni; CrIII; CrVI) I codici più standard (equivalenti alla serie B, vedere pagine (174-181), saranno forniti abitualmente in Zn/Ni.

## Racores DIN 2353

Raccords à bague DIN 2353  
DIN 2353 Pipe fittings  
Raccordi ad anello DIN 2353

Pipe

DIN 2353 Pipe Fittings

Gas tube fittings

JIC 37° fittings

SAE Flanges

Clamps

Machines for  
processing rigid pipes

### Unión recta tubo-tubo



#### Union double

#### Straight coupling

#### Raccordo intermedio diritto

TUBO PIPE	SERIE	REF. PART N°	€	REFERENCIA STA PART N° STA	€
4	LL	DLL 4	2,31	STA DLL 4	0,93
6	LL	DLL 6	2,56	STA DLL 6	1,12
8	LL	DLL 8	2,61	STA DLL 8	1,13
6	L	DL 6	2,19	STA DL 6	0,82
8	L	DL 8	2,48	STA DL 8	0,93
10	L	DL 10	2,98	STA DL 10	1,16
12	L	DL 12	3,51	STA DL 12	1,33
15	L	DL 15	5,10	STA DL 15	1,96
18	L	DL 18	7,20	STA DL 18	2,63
22	L	DL 22	10,01	STA DL 22	3,71
28	L	DL 28	18,01	STA DL 28	7,29
35	L	DL 35	25,61	STA DL 35	10,69
42	L	DL 42	36,99	STA DL 42	15,36
6	S	DS 6	2,81	STA DS 6	1,69
8	S	DS 8	3,20	STA DS 8	1,51
10	S	DS 10	3,79	STA DS 10	1,57
12	S	DS 12	4,35	STA DS 12	1,74
14	S	DS 14	7,92	STA DS 14	3,74
16	S	DS 16	7,84	STA DS 16	3,02
20	S	DS 20	12,19	STA DS 20	4,73
25	S	DS 25	21,06	STA DS 25	7,62
30	S	DS 30	29,69	STA DS 30	12,37
38	S	DS 38	39,71	STA DS 38	15,78

### Unión recta en reducción tubo-tubo



#### Union double en réduction

#### Straight reducing coupling

#### Raccordo intermedio di riduzione

TUBO PIPE	S.	REFERENCIA PART N°	€	REFERENCIA STA PART N° STA	€
8	6	L DL 8-6	4,73	STA DL 8-6	3,07
10	6	L DL 10-6	5,23	STA DL 10-6	3,41
10	8	L DL 10-8	5,42	STA DL 10-8	3,51
12	8	L DL 12-8	6,06	STA DL 12-8	3,94
12	10	L DL 12-10	6,27	STA DL 12-10	4,01
15	10	L DL 15-10	7,92	STA DL 15-10	5,11
15	12	L DL 15-12	8,10	STA DL 15-12	5,12
18	12	L DL 18-12	10,77	STA DL 18-12	6,94
18	15	L DL 18-15	11,38	STA DL 18-15	7,08
22	15	L DL 22-15	14,25	STA DL 22-15	8,98
22	18	L DL 22-18	15,08	STA DL 22-18	9,10
28	22	L DL 28-22	28,93	STA DL 28-22	19,16
35	22	L DL 35-22	38,50	STA DL 35-22	26,15
35	28	L DL 35-28	41,29	STA DL 35-28	26,83
42	35	L DL 42-35	61,95	STA DL 42-35	41,10
8	6	S DS 8-6	6,80	STA DS 8-6	4,75
10	6	S DS 10-6	10,37	STA DS 10-6	7,84
10	8	S DS 10-8	8,57	STA DS 10-8	6,11
12	6	S DS 12-6	8,71	STA DS 12-6	6,16
12	8	S DS 12-8	8,78	STA DS 12-8	6,14
12	10	S DS 12-10	9,06	STA DS 12-10	6,22
14	10	S DS 14-10	16,55	STA DS 14-10	12,45
14	12	S DS 14-12	16,27	STA DS 14-12	12,03
16	12	S DS 16-12	11,74	STA DS 16-12	7,55
16	14	S DS 16-14	16,87	STA DS 16-14	11,61
20	12	S DS 20-12	18,60	STA DS 20-12	12,70
20	16	S DS 20-16	17,12	STA DS 20-16	10,38
25	16	S DS 25-16	31,34	STA DS 25-16	20,78
25	20	S DS 25-20	31,09	STA DS 25-20	19,43
30	20	S DS 30-20	41,92	STA DS 30-20	27,77
30	25	S DS 30-25	44,89	STA DS 30-25	27,87
38	30	S DS 38-30	62,92	STA DS 38-30	39,92

Por razones logísticas y de producción, estos productos se suministrarán según disponibilidad (Zn/Ni; CrIII; CrVI). Las referencias más estándar (equivalentes a la serie B, ver págs. (174-181), se suministrarán habitualmente en Zn/Ni. / Pour des raisons logistiques et de fabrication, les produits (Zn/Ni; CrIII; CrVI) seront fournis selon disponibilité. Les références standard, équivalentes à la série B, voir pages (174-181), seront fournies normalement en Zn/Ni. / For logistics and manufacturing reasons, products (Zn/Ni; CrIII; CrVI) will be supplied upon availability. Standard references, equivalent to B series, see pages (174-181), will, usually, be supplied in Zn/Ni. / Per ragioni di logistica e di produzione, questi articoli saranno forniti secondo la disponibilità (Zn/Ni; CrIII; CrVI) I codici più standard (equivalenti alla serie B, vedere pagine (174-181), saranno forniti abitualmente in Zn/Ni.

# Racores DIN 2353

Raccords à bague DIN 2353  
DIN 2353 Pipe fittings  
Raccordi ad anello DIN 2353

## Unión en codo tubo-tubo



### Coude égal

Equal elbow coupling  
Raccordo intermedio a 90°

TUBO PIPE	SERIE	REF. PART N°	€	REFERENCIA STA PART N° STA	€
4	LL	ELL 4	5,40	STA ELL 4	3,76
6	LL	ELL 6	5,45	STA ELL 6	3,76
8	LL	ELL 8	5,95	STA ELL 8	4,19
6	L	EL 6	5,30	STA EL 6	3,67
8	L	EL 8	5,73	STA EL 8	3,91
10	L	EL 10	6,11	STA EL 10	4,03
12	L	EL 12	7,19	STA EL 12	4,70
15	L	EL 15	9,96	STA EL 15	6,41
18	L	EL 18	12,96	STA EL 18	7,90
22	L	EL 22	18,32	STA EL 22	11,32
28	L	EL 28	29,02	STA EL 28	17,37
35	L	EL 35	42,71	STA EL 35	26,35
42	L	EL 42	60,47	STA EL 42	36,86
6	S	ES 6	6,23	STA ES 6	4,32
8	S	ES 8	6,71	STA ES 8	4,58
10	S	ES 10	7,70	STA ES 10	5,15
12	S	ES 12	8,71	STA ES 12	5,74
14	S	ES 14	14,64	STA ES 14	9,90
16	S	ES 16	13,40	STA ES 16	8,11
20	S	ES 20	19,16	STA ES 20	11,11
25	S	ES 25	32,33	STA ES 25	17,95
30	S	ES 30	45,23	STA ES 30	26,60
38	S	ES 38	63,72	STA ES 38	37,77

## Unión en te tubo-tubo

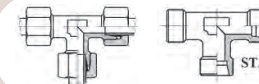

### Té égal

Equal Tee  
Raccordo intermedio a T

TUBO PIPE	SERIE	REF. PART N°	€	REFERENCIA STA PART N° STA	€
4	LL	TLL 4	6,67	STA TLL 4	4,33
6	LL	TLL 6	6,73	STA TLL 6	4,33
8	LL	TLL 8	7,80	STA TLL 8	5,25
6	L	TL 6	6,82	STA TL 6	4,47
8	L	TL 8	7,45	STA TL 8	4,82
10	L	TL 10	8,33	STA TL 10	5,28
12	L	TL 12	10,01	STA TL 12	6,34
15	L	TL 15	13,48	STA TL 15	8,27
18	L	TL 18	17,74	STA TL 18	10,29
22	L	TL 22	25,33	STA TL 22	15,01
28	L	TL 28	40,97	STA TL 28	23,71
35	L	TL 35	56,27	STA TL 35	32,40
42	L	TL 42	86,16	STA TL 42	51,13
6	S	TS 6	8,13	STA TS 6	5,36
8	S	TS 8	9,02	STA TS 8	5,92
10	S	TS 10	10,25	STA TS 10	6,52
12	S	TS 12	11,29	STA TS 12	6,97
14	S	TS 14	20,02	STA TS 14	13,06
16	S	TS 16	18,49	STA TS 16	10,69
20	S	TS 20	29,93	STA TS 20	17,76
25	S	TS 25	45,52	STA TS 25	24,20
30	S	TS 30	59,99	STA TS 30	32,71
38	S	TS 38	88,06	STA TS 38	49,76

## Unión en cruz tubo-tubo



### Croix égale

Equal cross  
Raccordo intermedio a croce

TUBO PIPE	SERIE	REF. PART N°	€	REFERENCIA STA PART N° STA	€
8	LL	KVLL 8	27,23	STA KVLL 8	22,41
6	L	KVL 6	21,59	STA KVL 6	17,40
8	L	KVL 8	20,46	STA KVL 8	19,17
10	L	KVL 10	22,59	STA KVL 10	20,63
12	L	KVL 12	28,68	STA KVL 12	22,50
18	L	KVL 18	43,22	STA KVL 18	31,64
22	L	KVL 22	71,82	STA KVL 22	54,86
28	L	KVL 28	82,71	STA KVL 28	57,33
35	L	KVL 35	114,68	STA KVL 35	79,50
42	L	KVL 42	185,86	STA KVL 42	133,17
6	S	KVS 6	26,17	STA KVS 6	21,18
8	S	KVS 8	28,57	STA KVS 8	23,05
10	S	KVS 10	30,60	STA KVS 10	24,21
12	S	KVS 12	32,50	STA KVS 12	25,29
14	S	KVS 14	47,92	STA KVS 14	36,85
16	S	KVS 16	46,37	STA KVS 16	34,14
20	S	KVS 20	75,98	STA KVS 20	56,71
25	S	KVS 25	85,14	STA KVS 25	54,65
30	S	KVS 30	115,36	STA KVS 30	76,01
38	S	KVS 38	182,05	STA KVS 38	125,55

Por razones logísticas y de producción, estos productos se suministrarán según disponibilidad (Zn/Ni; CrIII; CrVI). Las referencias más estándar (equivalentes a la serie B, ver págs. (174-181), se suministrarán habitualmente en Zn/Ni. / Pour des raisons logistiques et de fabrication, les produits (Zn/Ni; CrIII; CrVI) seront fournis selon disponibilité. Les références standard, équivalentes à la série B, voir pages (174-181), seront fournies normalement en Zn/Ni. / For logistics and manufacturing reasons, products (Zn/Ni; CrIII; CrVI) will be supplied upon availability. Standard references, equivalent to B series, see pages (174-181), will, usually, be supplied in Zn/Ni. / Per ragioni di logistica e di produzione, questi articoli saranno forniti secondo la disponibilità (Zn/Ni; CrIII; CrVI) I codici più standard (equivalenti alla serie B, vedere pagine (174-181), saranno forniti abitualmente in Zn/Ni.

# Racores DIN 2353

Raccords à bague DIN 2353  
DIN 2353 Pipe fittings  
Raccordi ad anello DIN 2353

Pipe

DIN 2353 Pipe Fittings

Gas tube fittings

JIC 37° fittings

SAE Flanges

Clamps

Machines for  
processing rigid pipes

## Racor recto rosca cónica BSPT

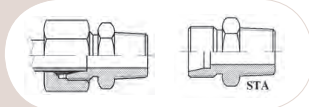

### Union simple mâle conique

Straight male stud coupling BSPT tapered  
Raccordo di estremità diritto conico BSPT

T. P.	S.	ROSCA THREAD	REFERENCIA PART N°	€	REFERENCIA STA PART N° STA	€
4	LL	1/8" BSPT	AKLL 4 R 1/8	1,41	STA AKLL 4 R 1/8	0,70
6	LL	1/8" BSPT	AKLL 6 R 1/8	1,47	STA AKLL 6 R 1/8	0,73
8	LL	1/8" BSPT	AKLL 8 R 1/8	1,64	STA AKLL 8 R 1/8	0,87
8	LL	1/4" BSPT	AKLL 8 R 1/4	1,94	STA AKLL 8 R 1/4	1,14
6	L	1/8" BSPT	AKL 6 R 1/8	1,60	STA AKL 6 R 1/8	0,87
6	L	1/4" BSPT	AKL 6 R 1/4	2,10	STA AKL 6 R 1/4	1,33
8	L	1/4" BSPT	AKL 8 R 1/4	2,31	STA AKL 8 R 1/4	1,45
10	L	1/4" BSPT	AKL 10 R 1/4	2,61	STA AKL 10 R 1/4	1,60
10	L	3/8" BSPT	AKL 10 R 3/8	3,01	STA AKL 10 R 3/8	1,97
12	L	1/4" BSPT	AKL 12 R 1/4	2,99	STA AKL 12 R 1/4	1,79
12	L	3/8" BSPT	AKL 12 R 3/8	2,83	STA AKL 12 R 3/8	1,65
12	L	1/2" BSPT	AKL 12 R 1/2	3,55	STA AKL 12 R 1/2	2,31
15	L	3/8" BSPT	AKL 15 R 3/8	8,84	STA AKL 15 R 3/8	6,74
15	L	1/2" BSPT	AKL 15 R 1/2	4,22	STA AKL 15 R 1/2	2,51
18	L	1/2" BSPT	AKL 18 R 1/2	6,68	STA AKL 18 R 1/2	4,45
22	L	3/4" BSPT	AKL 22 R 3/4	7,42	STA AKL 22 R 3/4	4,07
6	S	1/4" BSPT	AKS 6 R 1/4	2,66	STA AKS 6 R 1/4	1,74
8	S	1/4" BSPT	AKS 8 R 1/4	2,91	STA AKS 8 R 1/4	1,89
10	S	3/8" BSPT	AKS 10 R 3/8	3,55	STA AKS 10 R 3/8	2,30
12	S	3/8" BSPT	AKS 12 R 3/8	4,20	STA AKS 12 R 3/8	2,73
16	S	1/2" BSPT	AKS 16 R 1/2	6,20	STA AKS 16 R 1/2	3,59
20	S	3/4" BSPT	AKS 20 R 3/4	9,65	STA AKS 20 R 3/4	5,62

## Racor recto rosca cilíndrica BSP

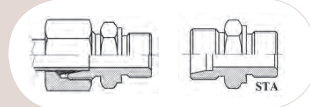

### Union simple mâle gaz cyl

Straight male stud coupling BSP cyl  
Raccordo di estremità diritto BSP

T. P.	S.	ROSCA THREAD	REFERENCIA PART N°	€	REFERENCIA STA PART N° STA	€
6	L	1/8" BSP	AL 6 R 1/8	1,48	STA AL 6 R 1/8	0,76
6	L	1/4" BSP	AL 6 R 1/4	2,19	STA AL 6 R 1/4	1,41
6	L	3/8" BSP	AL 6 R 3/8	3,04	STA AL 6 R 3/8	2,19
6	L	1/2" BSP	AL 6 R 1/2	11,33	STA AL 6 R 1/2	9,78
8	L	1/8" BSP	AL 8 R 1/8	3,15	STA AL 8 R 1/8	2,22
8	L	1/4" BSP	AL 8 R 1/4	1,90	STA AL 8 R 1/4	1,08
8	L	3/8" BSP	AL 8 R 3/8	2,79	STA AL 8 R 3/8	1,89
8	L	1/2" BSP	AL 8 R 1/2	6,00	STA AL 8 R 1/2	4,83
10	L	1/8" BSP	AL 10 R 1/8	4,99	STA AL 10 R 1/8	3,78
10	L	1/4" BSP	AL 10 R 1/4	2,13	STA AL 10 R 1/4	1,16
10	L	3/8" BSP	AL 10 R 3/8	2,74	STA AL 10 R 3/8	1,73
10	L	1/2" BSP	AL 10 R 1/2	4,44	STA AL 10 R 1/2	3,28
12	L	1/4" BSP	AL 12 R 1/4	2,97	STA AL 12 R 1/4	1,78
12	L	1/2" BSP	AL 12 R 1/2	4,07	STA AL 12 R 1/2	2,78
12	L	3/4" BSP	AL 12 R 3/4	8,44	STA AL 12 R 3/4	6,79
12	L	3/8" BSP	AL 12 R 3/8	2,75	STA AL 12 R 3/8	1,58
15	L	3/8" BSP	AL 15 R 3/8	4,83	STA AL 15 R 3/8	3,07
15	L	1/2" BSP	AL 15 R 1/2	3,95	STA AL 15 R 1/2	2,26
15	L	3/4" BSP	AL 15 R 3/4	14,28	STA AL 15 R 3/4	*
18	L	1/2" BSP	AL 18 R 1/2	4,79	STA AL 18 R 1/2	2,40
18	L	3/4" BSP	AL 18 R 3/4	9,06	STA AL 18 R 3/4	6,31
18	L	3/8" BSP	AL 18 R 3/8	10,14	STA AL 18 R 3/8	7,31
22	L	1/2" BSP	AL 22 R 1/2	12,55	STA AL 22 R 1/2	8,77
22	L	3/4" BSP	AL 22 R 3/4	7,22	STA AL 22 R 3/4	4,21
22	L	1" BSP	AL 22 R 1	31,00	STA AL 22 R 1	25,66
28	L	3/4" BSP	AL 28 R 3/4	29,87	STA AL 28 R 3/4	22,76
28	L	1" BSP	AL 28 R 1	13,05	STA AL 28 R 1	7,34
35	L	1" BSP	AL 35 R 1	37,99	STA AL 35 R 1	28,41
35	L	1 1/4" BSP	AL 35 R 1 1/4	18,89	STA AL 35 R 1 1/4	10,93
42	L	1 1/2" BSP	AL 42 R 1 1/2	24,64	STA AL 42 R 1 1/2	13,31
6	S	1/4" BSP	AS 6 R 1/4	2,09	STA AS 6 R 1/4	1,38
8	S	1/4" BSP	AS 8 R 1/4	2,34	STA AS 8 R 1/4	1,36
8	S	3/8" BSP	AS 8 R 3/8	5,77	STA AS 8 R 3/8	4,50
10	S	1/4" BSP	AS 10 R 1/4	4,34	STA AS 10 R 1/4	3,02
10	S	3/8" BSP	AS 10 R 3/8	3,01	STA AS 10 R 3/8	1,96
10	S	1/2" BSP	AS 10 R 1/2	4,68	STA AS 10 R 1/2	3,34
12	S	1/4" BSP	AS 12 R 1/4	5,76	STA AS 12 R 1/4	4,16
12	S	3/8" BSP	AS 12 R 3/8	3,30	STA AS 12 R 3/8	1,90
12	S	1/2" BSP	AS 12 R 1/2	4,67	STA AS 12 R 1/2	3,55
14	S	3/8" BSP	AS 14 R 3/8	18,12	STA AS 14 R 3/8	14,84
14	S	1/2" BSP	AS 14 R 1/2	5,68	STA AS 14 R 1/2	3,45
16	S	3/8" BSP	AS 16 R 3/8	11,20	sta AS 16 R 3/8	8,17
16	S	1/2" BSP	AS 16 R 1/2	5,32	STA AS 16 R 1/2	2,79
16	S	3/4" BSP	AS 16 R 3/4	8,99	STA AS 16 R 3/4	6,15
20	S	1/2" BSP	AS 20 R 1/2	14,44	STA AS 20 R 1/2	10,01
20	S	3/4" BSP	AS 20 R 3/4	8,32	STA AS 20 R 3/4	4,40
25	S	3/4" BSP	AS 25 R 3/4	22,45	STA AS 25 R 3/4	14,73
25	S	1" BSP	AS 25 R 1	14,89	STA AS 25 R 1	7,81
30	S	1" BSP	AS 30 R 1	28,16	STA AS 30 R 1	18,38
30	S	1 1/4" BSP	AS 30 R 1 1/4	22,85	STA AS 30 R 1 1/4	13,52
38	S	1 1/4" BSP	AS 38 R 1 1/4	32,61	STA AS 38 R 1 1/4	19,57
38	S	1 1/2" BSP	AS 38 R 1 1/2	28,02	STA AS 38 R 1 1/2	15,37

Por razones logísticas y de producción, estos productos se suministrarán según disponibilidad (Zn/Ni; CrIII; CrVI). Las referencias más estándar (equivalentes a la serie B, ver págs. (174-181), se suministrarán habitualmente en Zn/Ni. / Pour des raisons logistiques et de fabrication, les produits (Zn/Ni; CrIII; CrVI) seront fournis selon disponibilité. Les références standard, équivalentes à la série B, voir pages (174-181), seront fournies normalement en Zn/Ni. / For logistics and manufacturing reasons, products (Zn/Ni; CrIII; CrVI) will be supplied upon availability. Standard references, equivalent to B series, see pages (174-181), will, usually, be supplied in Zn/Ni. / Per ragioni di logistica e di produzione, questi articoli saranno forniti secondo la disponibilità (Zn/Ni; CrIII; CrVI) I codici più standard (equivalenti alla serie B, vedere pagine (174-181), saranno forniti abitualmente in Zn/Ni.

# Racores DIN 2353

Raccords à bague DIN 2353  
DIN 2353 Pipe fittings  
Raccordi ad anello DIN 2353

## Racor recto rosca cilíndrica BSP con junta

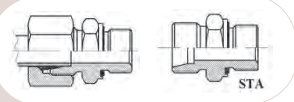

Union simple mâle gaz cyl avec o'ring

Straight male stud coupling with captive seal BSP cyl  
Raccordo di estremità diritto BSP con o'ring

T. P.	S.	ROSCA THREAD	REFERENCIA PART N°	€	REFERENCIA STA PART N° STA	€
6	L	1/4" BSP	AL 6 R 1/4 WD	2,67	STA AL 6 R 1/4 WD	1,85
6	L	1/8" BSP	AL 6 R 1/8 WD	1,89	STA AL 6 R 1/8 WD	1,14
8	L	1/4" BSP	AL 8 R 1/4 WD	2,41	STA AL 8 R 1/4 WD	1,53
8	L	1/8" BSP	AL 8 R 1/8 WD	3,49	STA AL 8 R 1/8 WD	2,53
8	L	3/8" BSP	AL 8 R 3/8 WD	3,25	STA AL 8 R 3/8 WD	2,31
10	L	1/2" BSP	AL 10 R 1/2 WD	4,99	STA AL 10 R 1/2 WD	3,78
10	L	1/4" BSP	AL 10 R 1/4 WD	2,57	STA AL 10 R 1/4 WD	1,58
10	L	3/8" BSP	AL 10 R 3/8 WD	3,23	STA AL 10 R 3/8 WD	2,18
12	L	1/2" BSP	AL 12 R 1/2 WD	4,63	STA AL 12 R 1/2 WD	3,30
12	L	1/4" BSP	AL 12 R 1/4 WD	3,46	STA AL 12 R 1/4 WD	2,23
12	L	3/8" BSP	AL 12 R 3/8 WD	3,23	STA AL 12 R 3/8 WD	2,02
15	L	1/2" BSP	AL 15 R 1/2 WD	4,54	STA AL 15 R 1/2 WD	2,80
15	L	3/8" BSP	AL 15 R 3/8 WD	5,26	STA AL 15 R 3/8 WD	3,46
18	L	1/2" BSP	AL 18 R 1/2 WD	5,32	STA AL 18 R 1/2 WD	2,89
18	L	3/4" BSP	AL 18 R 3/4 WD	9,50	STA AL 18 R 3/4 WD	6,71
22	L	3/4" BSP	AL 22 R 3/4 WD	7,63	STA AL 22 R 3/4 WD	4,26
28	L	1" BSP	AL 28 R 1 WD	13,98	STA AL 28 R 1 WD	8,20
42	L	1" 1/2 BSP	AL 42 R 1 1/2 WD	26,32	STA AL 42 R 1 1/2 WD	14,85
6	S	1/4" BSP	AS 6 R 1/4 WD	2,59	STA AS 6 R 1/4 WD	1,68
8	S	1/4" BSP	AS 8 R 1/4 WD	2,83	STA AS 8 R 1/4 WD	1,81
8	S	3/8" BSP	AS 8 R 3/8 WD	6,12	STA AS 8 R 3/8 WD	4,83
10	S	1/2" BSP	AS 10 R 1/2 WD	5,23	STA AS 10 R 1/2 WD	3,84
10	S	3/8" BSP	AS 10 R 3/8 WD	3,49	STA AS 10 R 3/8 WD	2,24
12	S	1/2" BSP	AS 12 R 1/2 WD	4,55	STA AS 12 R 1/2 WD	3,04
12	S	1/4" BSP	AS 12 R 1/4 WD	6,13	STA AS 12 R 1/4 WD	4,50
12	S	3/8" BSP	AS 12 R 3/8 WD	3,77	STA AS 12 R 3/8 WD	2,34
14	S	1/2" BSP	AS 14 R 1/2 WD	6,18	STA AS 14 R 1/2 WD	3,93
16	S	1/2" BSP	AS 16 R 1/2 WD	5,83	STA AS 16 R 1/2 WD	3,26
16	S	3/4" BSP	AS 16 R 3/4 WD	9,44	STA AS 16 R 3/4 WD	6,56
16	S	3/8" BSP	AS 16 R 3/8 WD	11,39	STA AS 16 R 3/8 WD	8,35
20	S	3/4" BSP	AS 20 R 3/4 WD	8,76	STA AS 20 R 3/4 WD	4,81
25	S	1" BSP	AS 25 R 1 WD	15,66	STA AS 25 R 1 WD	8,51
25	S	3/4" BSP	AS 25 R 3/4 WD	22,52	STA AS 25 R 3/4 WD	14,79
30	S	1" 1/4 BSP	AS 30 R 1 1/4 WD	23,71	STA AS 30 R 1 1/4 WD	14,30
38	S	1" 1/2 BSP	AS 38 R 1 1/2 WD	29,55	STA AS 38 R 1 1/2 WD	16,77

## Racor recto rosca cónica NPT

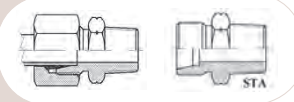

Union simple mâle NPT

Straight male stud coupling NPT  
Raccordo di estremità diritto NPT conico

T. P.	S.	ROSCA THREAD	REFERENCIA PART N°	€	REFERENCIA STA PART N° STA	€
4	LL	1/8" NPT	AKLL 4 1/8 NPT	2,20	STA AKLL 4 1/8 NPT	*
6	LL	1/8" NPT	AKLL 6 1/8 NPT	2,15	STA AKLL 6 1/8 NPT	*
8	LL	1/8" NPT	AKLL 8 1/8 NPT	2,41	STA AKLL 8 1/8 NPT	*
6	L	1/8" NPT	AKL 6 1/8 NPT	1,60	STA AKL 6 1/8 NPT	0,87
6	L	1/4" NPT	AKL 6 1/4 NPT	2,10	STA AKL 6 1/4 NPT	1,33
8	L	1/4" NPT	AKL 8 1/4 NPT	2,31	STA AKL 8 1/4 NPT	1,45
10	L	1/4" NPT	AKL 10 1/4 NPT	2,61	STA AKL 10 1/4 NPT	1,60
10	L	3/8" NPT	AKL 10 3/8 NPT	3,01	STA AKL 10 3/8 NPT	*
12	L	1/4" NPT	AKL 12 1/4 NPT	2,99	STA AKL 12 1/4 NPT	1,79
12	L	3/8" NPT	AKL 12 3/8 NPT	2,83	STA AKL 12 3/8 NPT	1,65
12	L	1/2" NPT	AKL 12 1/2 NPT	3,55	STA AKL 12 1/2 NPT	2,31
15	L	1/2" NPT	AKL 15 1/2 NPT	4,22	STA AKL 15 1/2 NPT	2,51
18	L	1/2" NPT	AKL 18 1/2 NPT	5,13	STA AKL 18 1/2 NPT	2,71
22	L	3/4" NPT	AKL 22 3/4 NPT	7,92	STA AKL 22 3/4 NPT	4,89
28	L	1" NPT	AKL 28 1 NPT	14,82	STA AKL 28 1 NPT	8,97
35	L	1" 1/4 NPT	AKL 35 1 1/4 NPT	23,93	STA AKL 35 1 1/4 NPT	15,53
6	S	1/4" NPT	AKS 6 1/4 NPT	2,66	STA AKS 6 1/4 NPT	1,74
8	S	1/4" NPT	AKS 8 1/4 NPT	2,91	STA AKS 8 1/4 NPT	1,89
10	S	1/4" NPT	AKS 10 1/4 NPT	3,33	STA AKS 10 1/4 NPT	2,09
10	S	3/8" NPT	AKS 10 3/8 NPT	3,55	STA AKS 10 3/8 NPT	2,30
12	S	3/8" NPT	AKS 12 3/8 NPT	4,20	STA AKS 12 3/8 NPT	2,73
12	S	1/2" NPT	AKS 12 1/2 NPT	4,35	STA AKS 12 1/2 NPT	3,13
14	S	1/2" NPT	AKS 14 1/2 NPT	6,80	STA AKS 14 1/2 NPT	4,47
16	S	1/2" NPT	AKS 16 1/2 NPT	6,20	STA AKS 16 1/2 NPT	3,59
20	S	3/4" NPT	AKS 20 3/4 NPT	9,65	STA AKS 20 3/4 NPT	5,62
25	S	1" NPT	AKS 25 1 NPT	16,71	STA AKS 25 1 NPT	9,47
30	S	1" 1/4 NPT	AKS 30 1 1/4 NPT	25,33	STA AKS 30 1 1/4 NPT	15,79

Pipe

DIN 2353 Pipe Fittings

Gas tube fittings

J/C 37° fittings

SAE Flanges

Clamps

Machines for processing rigid pipes

Por razones logísticas y de producción, estos productos se suministrarán según disponibilidad (Zn/Ni; CrIII; CrVI). Las referencias más estándar (equivalentes a la serie B, ver págs. (174-181), se suministrarán habitualmente en Zn/Ni. / Pour des raisons logistiques et de fabrication, les produits (Zn/Ni; CrIII; CrVI) seront fournis selon disponibilité. Les références standard, équivalentes à la série B, voir pages (174-181), seront fournies normalement en Zn/Ni. / For logistics and manufacturing reasons, products (Zn/Ni; CrIII; CrVI) will be supplied upon availability. Standard references, equivalent to B series, see pages (174-181), will, usually, be supplied in Zn/Ni. / Per ragioni di logistica e di produzione, questi articoli saranno forniti secondo la disponibilità (Zn/Ni; CrIII; CrVI) I codici più standard (equivalenti alla serie B, vedere pagine (174-181), saranno forniti abitualmente in Zn/Ni.

# Racores DIN 2353

Raccords à bague DIN 2353  
DIN 2353 Pipe fittings  
Raccordi ad anello DIN 2353

Pipe

DIN 2353 Pipe Fittings

Gas tube fittings

JIC 37° fittings

SAE Flanges

Clamps

Machines for processing rigid pipes

## Racor recto rosca cilíndrica UNF

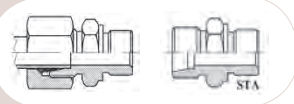

Union simple mâle UNF

Straight male stud coupling UNF  
Raccordo di estremità diritto UNF

T. P.	S.	ROSCA THREAD	REFERENCIA PART N°	€	REFERENCIA STA PART N° STA	€
8	L	7/16 UNF	AL 8 7/16 UNF	12,65	STA AL 8 7/16 UNF	10,92
10	L	7/16 UNF	AL 10 7/16 UNF	12,92	STA AL 10 7/16 UNF	11,05
12	L	9/16 UNF	AL 12 9/16 UNF	13,33	STA AL 12 9/16 UNF	11,26
12	L	3/4 UNF	AL 12 3/4 UNF	16,21	STA AL 12 3/4 UNF	13,91
12	L	7/8 UNF	AL 12 7/8 UNF	18,27	STA AL 12 7/8 UNF	15,79
15	L	3/4 UNF	AL 15 3/4 UNF	16,88	STA AL 15 3/4 UNF	14,10
15	L	7/8" UNF	AL 15 7/8 UNF	19,51	STA AL 15 7/8 UNF	16,52
18	L	3/4 UNF	AL 18 3/4 UNF	19,35	STA AL 18 3/4 UNF	15,74
18	L	7/8 UNF	AL 18 7/8 UNF	20,75	STA AL 18 7/8 UNF	17,03
22	L	7/8 UNF	AL 22 7/8 UNF	26,73	STA AL 22 7/8 UNF	21,75
22	L	1 1/16 UNF	AL 22 1 1/16 UN	26,24	STA AL 22 1 1/16 UNF	21,30
22	L	1 5/16 UNF	AL 22 1 5/16 UN	31,10	STA AL 22 1 5/16 UNF	25,75
28	L	1 1/16 UNF	AL 28 1 1/16 UN	34,04	STA AL 28 1 1/16 UNF	26,57
28	L	1 5/16 UNF	AL 28 1 5/16 UN	34,08	STA AL 28 1 5/16 UNF	26,61
35	L	1 5/16 UNF	AL 35 1 5/16 UN	41,11	STA AL 35 1 5/16 UNF	31,27
35	L	1 5/8 UNF	AL 35 1 5/8 UNF	44,85	STA AL 35 1 5/8 UNF	34,69
42	L	1 5/8 UNF	AL 42 1 5/8 UNF	56,85	STA AL 42 1 5/8 UNF	42,80
8	S	7/16 UNF	AS 8 7/16 UNF	12,67	STA AS 8 7/16 UNF	10,82
10	S	9/16 UNF	AS 10 9/16 UNF	14,07	STA AS 10 9/16 UNF	11,93
12	S	9/16 UNF	AS 12 9/16 UNF	16,91	STA AS 12 9/16 UNF	14,36
12	S	3/4 UNF	AS 12 3/4 UNF	17,87	STA AS 12 3/4 UNF	15,25
16	S	3/4 UNF	AS 16 3/4 UNF	18,39	STA AS 16 3/4 UNF	14,76
16	S	7/8 UNF	AS 16 7/8 UNF	22,79	STA AS 16 7/8 UNF	18,79
20	S	3/4 UNF	AS 20 3/4 UNF	29,27	STA AS 20 3/4 UNF	23,59
20	S	7/8 UNF	AS 20 7/8 UNF	29,31	STA AS 20 7/8 UNF	23,63
20	S	1 1/16 UNF	AS 20 1 1/16 UN	29,13	STA AS 20 1 1/16 UNF	23,46
25	S	1 5/16 UNF	AS 25 1 5/16 UNF	39,93	STA AS 25 1 5/16 UNF	30,74
30	S	1 5/16 UNF	AS 30 1 5/16 UNF	45,73	STA AS 30 1 5/16 UNF	34,47
30	S	1 5/8 UNF	AS 30 1 5/8 UNF	50,69	STA AS 30 1 5/8 UNF	39,01
38	S	1 5/8 UNF	AS 38 1 5/8 UNF	63,61	STA AS 38 1 5/8 UNF	47,96

## Racor recto rosca cilíndrica Métrica

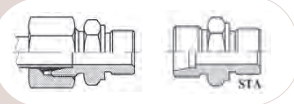

Union simple mâle Métrique

Straight male stud coupling Metrical cyl  
Raccordo di estremità diritto cilindrico Metrico

T. P.	S.	ROSCA THREAD	REFERENCIA PART N°	€	REFERENCIA STA PART N° STA	€
6	L	M10x1	AL 6 M 10X1	1,48	STA AL 6 M 10X1	0,76
8	L	M12x1,5	AL 8 M 12X1.5	1,86	STA AL 8 M 12X1.5	1,03
10	L	M14x1,5	AL 10 M 14X1.5	2,13	STA AL 10 M 14X1.5	1,16
10	L	M16x1,5	AL 10 M 16X1.5	4,14	STA AL 10 M 16X1.5	3,01
10	L	M18x1,5	AL 10 M 18X1.5	5,59	STA AL 10 M 18X1.5	4,34
10	L	M22x1,5	AL 10 M 22X1.5	10,81	STA AL 10 M 22X1.5	9,12
12	L	M14X1,5	AL 12 M 14X1.5	7,94	STA AL 12 M 14X1.5	6,33
12	L	M16x1,5	AL 12 M 16X1.5	2,79	STA AL 12 M 16X1.5	1,61
12	L	M18x1,5	AL 12 M 18X1.5	5,07	STA AL 12 M 18X1.5	3,70
12	L	M22x1,5	AL 12 M 22X1.5	5,74	STA AL 12 M 22X1.5	4,32
15	L	M16x1,5	AL 15 M 16X1.5	8,66	STA AL 15 M 16X1.5	6,58
15	L	M18x1,5	AL 15 M 18X1.5	3,44	STA AL 15 M 18X1.5	1,80
15	L	M22x1,5	AL 15 M 22X1.5	6,28	STA AL 15 M 22X1.5	4,40
18	L	M22x1,5	AL 18 M 22X1.5	4,82	STA AL 18 M 22X1.5	2,43
22	L	M22x1,5	AL 22 M 22X1.5	23,78	STA AL 22 M 22X1.5	19,05
22	L	M26x1,5	AL 22 M 26X1.5	10,12	STA AL 22 M 26X1.5	6,99
28	L	M33x2	AL 28 M 33X2	12,71	STA AL 28 M 33X2	7,03
35	L	M42x2	AL 35 M 42X2	20,52	STA AL 35 M 42X2	12,41
42	L	M48x2	AL 42 M 48X2	25,18	STA AL 42 M 48X2	13,80
6	S	M12x1,5	AS 6 M 12X1.5	2,12	STA AS 6 M 12X1.5	1,24
8	S	M14x1,5	AS 8 M 14X1.5	2,37	STA AS 8 M 14X1.5	1,51
10	S	M16x1,5	AS 10 M 16X1.5	3,00	STA AS 10 M 16X1.5	1,79
12	S	M18x1,5	AS 12 M 18X1.5	3,29	STA AS 12 M 18X1.5	1,89
12	S	M22x1,5	AS 12 M 22X1.5	21,34	STA AS 12 M 22X1.5	18,43
14	S	M20x1,5	AS 14 M 20X1.5	5,92	STA AS 14 M 20X1.5	3,67
16	S	M22x1,5	AS 16 M 22X1.5	5,32	STA AS 16 M 22X1.5	2,79
20	S	M27x2	AS 20 M 27X2	8,39	STA AS 20 M 27X2	4,47
25	S	M33x2	AS 25 M 33X2	14,75	STA AS 25 M 33X2	8,32
30	S	M42x2	AS 30 M 42X2	24,81	STA AS 30 M 42X2	15,31
38	S	M48x2	AS 38 M 48X2	31,27	STA AS 38 M 48X2	18,34

Por razones logísticas y de producción, estos productos se suministrarán según disponibilidad (Zn/Ni; CrIII; CrVI). Las referencias más estándar (equivalentes a la serie B, ver págs. (174-181), se suministrarán habitualmente en Zn/Ni. / Pour des raisons logistiques et de fabrication, les produits (Zn/Ni; CrIII; CrVI) seront fournis selon disponibilité. Les références standard, équivalentes à la série B, voir pages (174-181), seront fournies normalement en Zn/Ni. / For logistics and manufacturing reasons, products (Zn/Ni; CrIII; CrVI) will be supplied upon availability. Standard references, equivalent to B series, see pages (174-181), will, usually, be supplied in Zn/Ni. / Per ragioni di logistica e di produzione, questi articoli saranno forniti secondo la disponibilità (Zn/Ni; CrIII; CrVI) I codici più standard (equivalenti alla serie B, vedere pagine (174-181), saranno forniti abitualmente in Zn/Ni.



# Racores DIN 2353

Raccords à bague DIN 2353  
DIN 2353 Pipe fittings  
Raccordi ad anello DIN 2353

## Racor recto rosca cilíndrica Métrica con junta

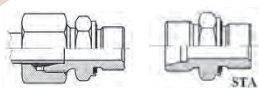

Union simple mâle Métrique cyl + o'ring

Straight male stud coupling with captive seal Metrical cyl  
Raccordo di estremità diritto cilindrico Metrico con o'ring

T. P.	S.	ROSCA THREAD	REFERENCIA PART N°	€	REFERENCIA STA PART N° STA	€
6	L	M10x1	AL 6 M 10X1 WD	1,91	STA AL 6 M 10X1 WD	1,16
8	L	M12x1,5	AL 8 M 12X1.5 WD	2,31	STA AL 8 M 12X1.5 WD	1,45
10	L	M14x1,5	AL 10 M 14X1.5 WD	2,62	STA AL 10 M 14X1.5 WD	1,61
10	L	M16x1,5	AL 10 M 16X1.5 WD	4,55	STA AL 10 M 16X1.5 WD	3,39
10	L	M18x1,5	AL 10 M 18X1.5 WD	6,02	STA AL 10 M 18X1.5 WD	4,73
12	L	M16x1,5	AL 12 M 16X1.5 WD	3,27	STA AL 12 M 16X1.5 WD	2,05
12	L	M18x1,5	AL 12 M 18X1.5 WD	5,53	STA AL 12 M 18X1.5 WD	4,12
12	L	M22x1,5	AL 12 M 22X1.5 WD	6,26	STA AL 12 M 22X1.5 WD	4,79
15	L	M18x1,5	AL 15 M 18X1.5 WD	3,99	STA AL 15 M 18X1.5 WD	2,30
15	L	M22x1,5	AL 15 M 22X1.5 WD	6,78	STA AL 15 M 22X1.5 WD	4,85
18	L	M22x1,5	AL 18 M 22X1.5 WD	5,40	STA AL 18 M 22X1.5 WD	2,96
22	L	M26x1,5	AL 22 M 26X1.5 WD	7,81	STA AL 22 M 26X1.5 WD	4,42
28	L	M33x2	AL 28 M 33X2 WD	13,69	STA AL 28 M 33X2 WD	7,93
35	L	M42x2	AL 35 M 42X2 WD	19,99	STA AL 35 M 42X2 WD	11,92
42	L	M48x2	AL 42 M 48X2 WD	27,15	STA AL 42 M 48X2 WD	15,60
6	S	M12x1,5	AS 6 M 12X1.5 WD	2,55	STA AS 6 M 12X1.5 WD	1,64
8	S	M14x1,5	AS 8 M 14X1.5 WD	2,85	STA AS 8 M 14X1.5 WD	1,83
10	S	M16x1,5	AS 10 M 16X1.5 WD	3,48	STA AS 10 M 16X1.5 WD	2,24
12	S	M18x1,5	AS 12 M 18X1.5 WD	3,83	STA AS 12 M 18X1.5 WD	2,69
14	S	M20x1,5	AS 14 M 20X1.5 WD	6,42	STA AS 14 M 20X1.5 WD	4,12
16	S	M22x1,5	AS 16 M 22X1.5 WD	5,91	STA AS 16 M 22X1.5 WD	4,71
20	S	M27x2	AS 20 M 27X2 WD	8,92	STA AS 20 M 27X2 WD	5,54
25	S	M33x2	AS 25 M 33X2 WD	15,72	STA AS 25 M 33X2 WD	9,58
30	S	M42x2	AS 30 M 42X2 WD	23,76	STA AS 30 M 42X2 WD	14,35
38	S	M48x2	AS 38 M 48X2 WD	29,91	STA AS 38 M 48X2 WD	19,07

## Reducción con rosca M-HF BSP con junta



Réduction mâle gaz-femelle gaz avec joint torique

Male-female reducing adaptor BSP cyl with captive seal  
Adattatore di riduzione filettato maschio-femmina BSP con o'ring

ROSCA THREAD	REFERENCIA PART N°	€
M 1/8" BSP	H 1/4" BSP	RI-R 1/8 R 1/4WD 3,75
M 1/8" BSP	H 3/8" BSP	RI-R 1/8 R 3/8WD 6,96
M 1/4" BSP	H 1/8" BSP	RI-R 1/4 R 1/8WD 2,18
M 1/4" BSP	H 3/8" BSP	RI-R 1/4 R 3/8WD 3,22
M 1/4" BSP	H 1/2" BSP	RI-R 1/4 R 1/2 WD 3,64
M 1/4" BSP	H 3/4" BSP	RI-R 1/4 R 3/4 WD 13,16
M 3/8" BSP	H 1/8" BSP	RI-R 3/8 R 1/8WD 2,40
M 3/8" BSP	H 1/4" BSP	RI-R 3/8 R 1/4 WD 2,33
M 3/8" BSP	H 1/2" BSP	RI-R 3/8 R 1/2WD 3,77
M 3/8" BSP	H 3/4" BSP	RI-R 3/8 R 3/4WD 11,18
M 1/2" BSP	H 1/8" BSP	RI-R 1/2 R 1/8WD 3,48
M 1/2" BSP	H 1/4" BSP	RI-R 1/2 R 1/4WD 2,62
M 1/2" BSP	H 3/8" BSP	RI-R 1/2 R 3/8WD 3,11
M 1/2" BSP	H 3/4" BSP	RI-R 1/2 R 3/4WD 10,08
M 1/2" BSP	H 1" BSP	RI-R 1/2 R 1WD 10,62
M 1/2" BSP	H 1" 1/4 BSP	RI-R 1/2 R 1 1/4WD 33,97
M 3/4" BSP	H 1/4" BSP	RI-R 3/4 R 1/4WD 3,86
M 3/4" BSP	H 3/8" BSP	RI-R 3/4 R 3/8WD 3,79
M 3/4" BSP	H 1/2" BSP	RI-R 3/4 R 1/2WD 4,60
M 3/4" BSP	H 1" BSP	RI-R 3/4 R 1WD 11,12
M 3/4" BSP	H 1" 1/4 BSP	RI-R 3/4 R 1 1/4WD 34,51
M 3/4" BSP	H 1" 1/2 BSP	RI-R 3/4 R 1 1/2WD 41,24
M 1" BSP	H 1/4" BSP	RI-R 1 R 1/4WD 8,27
M 1" BSP	H 3/8" BSP	RI-R 1 R 3/8WD 8,27
M 1" BSP	H 1/2" BSP	RI-R 1 R 1/2WD 6,86
M 1" BSP	H 3/4" BSP	RI-R 1 R 3/4WD 8,30
M 1" BSP	H 1" 1/4 BSP	RI-R 1 R 1 1/4WD 34,99
M 1" BSP	H 1" 1/2 BSP	RI-R 1 R 1 1/2WD 38,09
M 1" 1/4 BSP	H 1/2" BSP	RI-R 1 1/4 R 1/2WD 16,57
M 1" 1/4 BSP	H 3/4" BSP	RI-R 1 1/4 R 3/4WD 11,71
M 1" 1/4 BSP	H 1" BSP	RI-R 1 1/4 R 1WD 14,76
M 1" 1/4 BSP	H 1" 1/2 BSP	RI-R 1 1/4 R 1 1/2WD 46,45
M 1" 1/2 BSP	H 1/2" BSP	RI-R 1 1/2 R 1/2WD 32,18
M 1" 1/2 BSP	H 3/4" BSP	RI-R 1 1/2 R 3/4WD 17,15
M 1" 1/2 BSP	H 1" BSP	RI-R 1 1/2 R 1WD 17,27
M 1" 1/2 BSP	H 1" 1/4 BSP	RI-R 1 1/2 R 1 1/4WD 24,69

## Racor recto rosca cónica Métrica

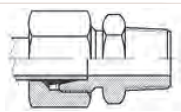

Union simple mâle métrique type A

Straight male stud coupling metrical tapered  
Raccordo di estremità diritto conico Metrico

TUBO PIPE	SERIE	ROSCA THREAD	REFERENCIA PART N°	€
4	LL	M 8x1	AKLL 4 M 8X1	1,46
6	LL	M 10x1	AKLL 6 M 10X1	1,56
8	LL	M 10x1	AKLL 8 M 10X1	1,71

Por razones logísticas y de producción, estos productos se suministrarán según disponibilidad (Zn/Ni; CrIII; CrVI). Las referencias más estándar (equivalentes a la serie B, ver págs. (174-181), se suministrarán habitualmente en Zn/Ni. / Pour des raisons logistiques et de fabrication, les produits (Zn/Ni; CrIII; CrVI) seront fournis selon disponibilité. Les références standard, équivalentes à la série B, voir pages (174-181), seront fournies normalement en Zn/Ni. / For logistics and manufacturing reasons, products (Zn/Ni; CrIII; CrVI) will be supplied upon availability. Standard references, equivalent to B series, see pages (174-181), will, usually, be supplied in Zn/Ni. / Per ragioni di logistica e di produzione, questi articoli saranno forniti secondo la disponibilità (Zn/Ni; CrIII; CrVI) I codici più standard (equivalenti alla serie B, vedere pagine (174-181), saranno forniti abitualmente in Zn/Ni.

\* Consultar | Sur demande | On request | Su richiesta

## Racores DIN 2353

Raccords à bague DIN 2353  
DIN 2353 Pipe fittings  
Raccordi ad anello DIN 2353

Pipe

DIN 2353 Pipe Fittings

Gas tube fittings

JIC 37° fittings

SAE Flanges

Clamps

Machines for  
processing rigid pipes

### Racor en codo rosca cónica BSPT



Union coude mâle gaz conique type G

Male stud elbow BSPT

Raccordo di estremità a 90° Metrico conico BSPT

T. P.	S.	ROSCA THREAD	REFERENCIA PART N°	€	REFERENCIA STA PART N° STA	€
4	LL	1/8" BSPT	CKLL 4 R 1/8	4,95	STA CKLL 4 R 1/8	3,94
6	LL	1/8" BSPT	CKLL 6 R 1/8	5,16	STA CKLL 6 R 1/8	4,12
8	LL	1/8" BSPT	CKLL 8 R 1/8	5,71	STA CKLL 6 R 1/8	4,12
6	L	1/8" BSPT	CKL 6 R 1/8	5,26	STA CKL 6 R 1/8	4,22
6	L	1/4" BSPT	CKL 6 R 1/4	5,59	STA CKL 6 R 1/4	4,52
8	L	1/8" BSPT	CKL 8 R 1/8	5,67	STA CKL 8 R 1/8	4,52
8	L	1/4" BSPT	CKL 8 R 1/4	5,61	STA CKL 8 R 1/4	4,47
8	L	3/8" BSPT	CKL 8 R 3/8	7,35	STA CKL 8 R 3/8	6,06
10	L	1/4" BSPT	CKL 10 R 1/4	6,26	STA CKL 10 R 1/4	4,95
10	L	3/8" BSPT	CKL 10 R 3/8	7,47	STA CKL 10 R 3/8	6,06
10	L	1/2" BSPT	CKL 10 R 1/2	8,81	STA CKL 10 R 1/2	7,29
12	L	1/4" BSPT	CKL 12 R 1/4	7,65	STA CKL 12 R 1/4	6,06
12	L	3/8" BSPT	CKL 12 R 3/8	7,53	STA CKL 12 R 3/8	5,96
12	L	1/2" BSPT	CKL 12 R 1/2	8,99	STA CKL 12 R 1/2	7,29
15	L	3/8" BSPT	CKL 15 R 3/8	9,44	STA CKL 15 R 3/8	7,29
15	L	1/2" BSPT	CKL 15 R 1/2	9,31	STA CKL 15 R 1/2	7,17
18	L	1/2" BSPT	CKL 18 R 1/2	11,89	STA CKL 18 R 1/2	8,91
22	L	3/4" BSPT	CKL 22 R 3/4	25,33	STA CKL 22 R 3/4	20,47
28	L	1" BSPT	CKL 28 R 1	39,11	STA CKL 28 R 1	31,21
35	L	1 1/4" BSPT	CKL 35 R 1 1/4	62,06	STA CKL 35 R 1 1/4	50,46
42	L	1 1/2" BSPT	CKL 42 R 1 1/2	72,20	STA CKL 42 R 1 1/2	56,86
6	S	1/4" BSPT	CKS 6 R 1/4	6,08	STA CKS 6 R 1/4	4,87
8	S	1/4" BSPT	CKS 8 R 1/4	7,07	STA CKS 8 R 1/4	5,69
10	S	3/8" BSPT	CKS 10 R 3/8	8,04	STA CKS 10 R 3/8	6,41
12	S	3/8" BSPT	CKS 12 R 3/8	9,01	STA CKS 12 R 3/8	7,13
12	S	1/2" BSPT	CKS 12 R 1/2	13,39	STA CKS 12 R 1/2	11,14
14	S	1/2" BSPT	CKS 14 R 1/2	14,08	STA CKS 14 R 1/2	11,14
16	S	1/2" BSPT	CKS 16 R 1/2	12,92	STA CKS 16 R 1/2	9,75
20	S	3/4" BSPT	CKS 20 R 3/4	32,43	STA CKS 20 R 3/4	26,48
25	S	1" BSPT	CKS 25 R 1	36,71	STA CKS 25 R 1	27,79
30	S	1 1/4" BSPT	CKS 30 R 1 1/4	64,53	STA CKS 30 R 1 1/4	51,69
38	S	1 1/2" BSPT	CKS 38 R 1 1/2	75,74	STA CKS 38 R 1 1/2	59,07

### Racor en codo rosca cónica Métrica



Equerre mâle Métrique type A

Male stud elbow Metrical tapered

Raccordo di estremità a 90° Metrico conico

T. P.	S.	ROSCA THREAD	REFERENCIA PART N°	€	REFERENCIA STA PART N° STA	€
4	LL	M8x1	CKLL 4 M 8X1	5,00	STA CKLL 4 M 8X1	3,99
6	LL	M10x1	CKLL 6 M 10X1	5,17	STA CKLL 6 M 10X1	4,13
8	LL	M10x1	CKLL 8 M 10X1	5,79	STA CKLL 8 M 10X1	4,66
6	L	M10x1	CKL 6 M 10X1	5,26	STA CKL 6 M 10X1	4,22
8	L	M12x1,5	CKL 8 M 12X1.5	5,71	STA CKL 8 M 12X1.5	*
10	L	M14x1,5	CKL 10 M 14X1.5	6,42	STA CKL 10 M 14X1.5	*
12	L	M16x1,5	CKL 12 M 16X1.5	7,73	STA CKL 12 M 16X1.5	6,14
15	L	M18x1,5	CKL 15 M 18X1.5	11,01	STA CKL 15 M 18X1.5	8,73
18	L	M22x1,5	CKL 18 M 22X1.5	15,40	STA CKL 18 M 22X1.5	12,12
6	S	M12x1,5	CKS 6 M 12X1.5	6,99	STA CKS 6 M 12X1.5	5,70
8	S	M14x1,5	CKS 8 M 14X1.5	8,02	STA CKS 8 M 14X1.5	6,57
10	S	M16x1,5	CKS 10 M 16X1.5	8,77	STA CKS 10 M 16X1.5	7,08
14	S	M20x1,5	CKS 14 M 20X1.5	20,53	STA CKS 14 M 20X1.5	17,04
16	S	M22x1,5	CKS 16 M 22X1.5	17,95	STA CKS 16 M 22X1.5	14,36

### Racor en codo rosca cónica NPT



Union coude mâle NPT

Male stud elbow NPT

Raccordo di estremità a 90° conico NPT

T. P.	S.	ROSCA THREAD	REFERENCIA PART N°	€	REFERENCIA STA PART N° STA	€
4	LL	1/8" NPT	CKLL 4 1/8 NPT	6,00	STA CKLL 4 1/8 NPT	4,90
6	LL	1/8" NPT	CKLL 6 1/8 NPT	6,04	STA CKLL 6 1/8 NPT	4,92
8	LL	1/8" NPT	CKLL 8 1/8 NPT	6,80	STA CKLL 8 1/8 NPT	5,60
6	L	1/8" NPT	CKL 6 1/8 NPT	5,89	STA CKL 6 1/8 NPT	4,80
6	L	1/4" NPT	CKL 6 1/4 NPT	8,46	STA CKL 6 1/4 NPT	7,16
8	L	1/4" NPT	CKL 8 1/4 NPT	6,38	STA CKL 8 1/4 NPT	5,17
10	L	1/4" NPT	CKL 10 1/4 NPT	7,07	STA CKL 10 1/4 NPT	5,69
12	L	1/4" NPT	CKL 12 1/4 NPT	9,91	STA CKL 12 1/4 NPT	8,13
12	L	3/8" NPT	CKL 12 3/8 NPT	8,64	STA CKL 12 3/8 NPT	6,97
12	L	1/2" NPT	CKL 12 1/2 NPT	14,89	STA CKL 12 1/2 NPT	12,70
15	L	1/2" NPT	CKL 15 1/2 NPT	11,44	STA CKL 15 1/2 NPT	9,13
18	L	1/2" NPT	CKL 18 1/2 NPT	16,32	STA CKL 18 1/2 NPT	12,96
22	L	3/4" NPT	CKL 22 3/4 NPT	24,16	STA CKL 22 3/4 NPT	19,40
28	L	1" NPT	CKL 28 1 NPT	34,99	STA CKL 28 1 NPT	27,44
6	S	1/4" NPT	CKS 6 1/4 NPT	6,91	STA CKS 6 1/4 NPT	5,63
8	S	1/4" NPT	CKS 8 1/4 NPT	7,99	STA CKS 8 1/4 NPT	6,53
10	S	3/8" NPT	CKS 10 3/8 NPT	8,89	STA CKS 10 3/8 NPT	7,18
12	S	3/8" NPT	CKS 12 3/8 NPT	9,89	STA CKS 12 3/8 NPT	7,94
14	S	1/2" NPT	CKS 14 1/2 NPT	20,94	STA CKS 14 1/2 NPT	17,42
16	S	1/2" NPT	CKS 16 1/2 NPT	12,86	STA CKS 16 1/2 NPT	13,14
20	S	3/4" NPT	CKS 20 3/4 NPT	23,57	STA CKS 20 3/4 NPT	18,37
25	S	1" NPT	CKS 25 1 NPT	44,49	STA CKS 25 1 NPT	34,91

Por razones logísticas y de producción, estos productos se suministrarán según disponibilidad (Zn/Ni; CrIII; CrVI). Las referencias más estándar (equivalentes a la serie B, ver págs. (174-181), se suministrarán habitualmente en Zn/Ni. / Pour des raisons logistiques et de fabrication, les produits (Zn/Ni; CrIII; CrVI) seront fournis selon disponibilité. Les références standard, équivalentes à la série B, voir pages (174-181), seront fournies normalement en Zn/Ni. / For logistics and manufacturing reasons, products (Zn/Ni; CrIII; CrVI) will be supplied upon availability. Standard references, equivalent to B series, see pages (174-181), will, usually, be supplied in Zn/Ni. / Per ragioni di logistica e di produzione, questi articoli saranno forniti secondo la disponibilità (Zn/Ni; CrIII; CrVI) I codici più standard (equivalenti alla serie B, vedere pagine (174-181), saranno forniti abitualmente in Zn/Ni.

# Racores DIN 2353

Raccords à bague DIN 2353  
DIN 2353 Pipe fittings  
Raccordi ad anello DIN 2353

## Racor de reducción TL Métrica (serie ligera)

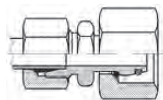

Union simple femelle tournante Métrique (L)  
Standpipe reducers with taper (L)  
Raccordo di riduzione cono 24 (L)

TUBO PIPE		SERIE	REFERENCIA PART N°	€
6	8	L	KORL 8-6TLM	4,42
6	10	L	KORL 10-6TLM	4,62
10	8	L	KORL 10-8 TLM	4,70
6	12	L	KORL 12-6TLM	4,90
8	12	L	KORL 12-8TLM	4,98
10	12	L	KORL 12-10TLM	5,11
6	15	L	KORL 15-6TLM	5,72
8	15	L	KORL 15-8TLM	5,54
10	15	L	KORL 15-10TLM	5,66
12	15	L	KORL 15-12TLM	5,84
6	18	L	KORL 18-6TLM	11,51
8	18	L	KORL 18-8TLM	7,18
10	18	L	KORL 18-10TLM	7,24
12	18	L	KORL 18-12TLM	7,41
15	18	L	KORL 18-15TLM	7,86
6	22	L	KORL 22-6TLM	14,79
8	22	L	KORL 22-8TLM	13,33
10	22	L	KORL 22-10TLM	12,52
12	22	L	KORL 22-12TLM	9,31
15	22	L	KORL 22-15TLM	9,76
18	22	L	KORL 22-18TLM	10,44
6	28	L	KORL 28-6TLM	22,90
8	28	L	KORL 28-8TLM	21,73
10	28	L	KORL 28-10TLM	18,09
12	28	L	KORL 28-12TLM	16,84
15	28	L	KORL 28-15TLM	17,00
18	28	L	KORL 28-18TLM	17,69
22	28	L	KORL 28-22TLM	18,50
15	35	L	KORL 35-15TLM	31,30
18	35	L	KORL 35-18TLM	26,63
22	35	L	KORL 35-22TLM	24,63
28	35	L	KORL 35-28TLM	25,96
18	42	L	KORL 42-18TLM	48,11
22	42	L	KORL 42-22TLM	32,00
28	42	L	KORL 42-28TLM	32,38
35	42	L	KORL 42-35TLM	36,83

## Racor de reducción TL Métrica (serie pesada)

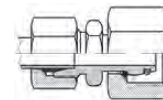

Union simple femelle tournante Métrique (S)  
Standpipe reducers with taper (S)  
Raccordo di riduzione cono 24 (S)

TUBO PIPE		SERIE	REFERENCIA PART N°	€
6	8	S	KORS 8-6TLM	9,84
6	10	S	KORS 10-6TLM	6,53
8	10	S	KORS 10-8TLM	6,63
6	12	S	KORS 12-6TLM	4,95
8	12	S	KORS 12-8TLM	5,77
10	12	S	KORS 12-10TLM	5,96
6	14	S	KORS 14-6TLM	15,48
8	14	S	KORS 14-8TLM	15,20
10	14	S	KORS 14-10TLM	15,39
12	14	S	KORS 14-12TLM	15,57
8	16	S	KORS 16-8TLM	7,75
10	16	S	KORS 16-10TLM	7,94
12	16	S	KORS 16-12TLM	8,12
14	16	S	KORS 16-14TLM	18,03
6	20	S	KORS 20-6TLM	13,96
8	20	S	KORS 20-8TLM	13,35
10	20	S	KORS 20-10TLM	11,64
12	20	S	KORS 20-12TLM	10,12
14	20	S	KORS 20-14TLM	24,54
16	20	S	KORS 20-16TLM	11,18
6	25	S	KORS 25-6TLM	23,63
8	25	S	KORS 25-8TLM	23,28
10	25	S	KORS 25-10TLM	21,55
12	25	S	KORS 25-12TLM	17,39
14	25	S	KORS 25-14TLM	36,64
16	25	S	KORS 25-16TLM	17,49
20	25	S	KORS 25-20TLM	19,38
10	30	S	KORS 30-10TLM	26,58
12	30	S	KORS 30-12TLM	22,74
16	30	S	KORS 30-16TLM	22,79
20	30	S	KORS 30-20TLM	23,55
25	30	S	KORS 30-25TLM	27,44
12	38	S	KORS 38-12TLM	43,93
16	38	S	KORS 38-16TLM	37,60
20	38	S	KORS 38-20TLM	36,31
25	38	S	KORS 38-25TLM	39,17
30	38	S	KORS 38-30TLM	40,89

Por razones logísticas y de producción, estos productos se suministrarán según disponibilidad (Zn/Ni; CrIII; CrVI). Las referencias más estándar (equivalentes a la serie B, ver págs. (174-181), se suministrarán habitualmente en Zn/Ni. / Pour des raisons logistiques et de fabrication, les produits (Zn/Ni; CrIII; CrVI) seront fournis selon disponibilité. Les références standard, équivalentes à la série B, voir pages (174-181), seront fournies normalement en Zn/Ni. / For logistics and manufacturing reasons, products (Zn/Ni; CrIII; CrVI) will be supplied upon availability. Standard references, equivalent to B series, see pages (174-181), will, usually, be supplied in Zn/Ni. / Per ragioni di logistica e di produzione, questi articoli saranno forniti secondo la disponibilità (Zn/Ni; CrIII; CrVI) I codici più standard (equivalenti alla serie B, vedere pagine (174-181), saranno forniti abitualmente in Zn/Ni.

# Racores DIN 2353

Raccords à bague DIN 2353  
DIN 2353 Pipe fittings  
Raccordi ad anello DIN 2353

Pipe

DIN 2353 Pipe Fittings

Gas tube fittings

JIC 37° fittings

SAE Flanges

Clamps

Machines for processing rigid pipes

## Racor en codo regulable con tuerca y anillo



**Coude orientable tube lisse équipé**  
**Adjustable stud elbow with nut and ring**  
**Raccordo orientabile a 90° con dado e anello**

T. P.	S.	ROSCA THREAD	REFERENCIA PART N°	€	REFERENCIA STA PART N° STA	€
6	L	M12x1,5	EEL 6 CTA	6,08	STA EEL 6 CTA	4,98
8	L	M14x1,5	EEL 8 CTA	6,09	STA EEL 8 CTA	4,91
10	L	M16x1,5	EEL 10 CTA	6,78	STA EEL 10 CTA	5,42
12	L	M18x1,5	EEL 12 CTA	8,44	STA EEL 12 CTA	6,79
15	L	M22x1,5	EEL 15 CTA	10,23	STA EEL 15 CTA	8,01
18	L	M26x1,5	EEL 18 CTA	13,97	STA EEL 18 CTA	10,81
22	L	M30x2	EEL 22 CTA	19,58	STA EEL 22 CTA	15,20
28	L	M36x2	EEL 28 CTA	30,68	STA EEL 28 CTA	23,49
35	L	M45x2	EEL 35 CTA	47,54	STA EEL 35 CTA	37,15
42	L	M52x2	EEL 42 CTA	68,11	STA EEL 42 CTA	53,12
6	S	M14x1,5	EES 6 CTA	6,93	STA EES 6 CTA	5,65
8	S	M16x1,5	EES 8 CTA	7,80	STA EES 8 CTA	6,36
10	S	M18x1,5	EES 10 CTA	8,86	STA EES 10 CTA	7,16
12	S	M20x1,5	EES 12 CTA	9,58	STA EES 12 CTA	7,65
14	S	M22x1,5	EES 14 CTA	14,37	STA EES 14 CTA	11,41
16	S	M24x1,5	EES 16 CTA	14,30	STA EES 16 CTA	11,02
20	S	M30x2	EES 20 CTA	21,99	STA EES 20 CTA	16,92
25	S	M36x2	EES 25 CTA	34,89	STA EES 25 CTA	26,13
30	S	M42x2	EES 30 CTA	49,67	STA EES 30 CTA	38,09
38	S	M52x2	EES 38 CTA	71,87	STA EES 38 CTA	55,52

## Racor en L regulable con tuerca y anillo

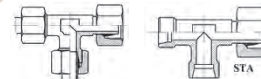

**L Orientable renversé tube lisse équipé**  
**Adjustable stud barrel L with nut and ring**  
**Raccordo orientabile a T con dado e anello laterale**

TUBO PIPE	S.	ROSCA THREAD	REFERENCIA PART N°	€	REFERENCIA STA PART N° STA	€
6	6	L M12x1,5	LEL 6 CTA	9,12	STA LEL 6 CTA	7,17
8	8	L M14x1,5	LEL 8 CTA	9,54	STA LEL 8 CTA	7,40
10	10	L M16x1,5	LEL 10 CTA	10,78	STA LEL 10 CTA	8,30
12	12	L M18x1,5	LEL 12 CTA	12,18	STA LEL 12 CTA	9,27
15	15	L M22x1,5	LEL 15 CTA	16,21	STA LEL 15 CTA	12,14
18	18	L M26x1,5	LEL 18 CTA	21,61	STA LEL 18 CTA	15,82
22	22	L M30x2	LEL 22 CTA	32,10	STA LEL 22 CTA	23,95
28	28	L M36x2	LEL 28 CTA	49,84	STA LEL 28 CTA	36,44
35	35	L M45x2	LEL 35 CTA	68,77	STA LEL 35 CTA	50,22
42	42	L M52x2	LEL 42 CTA	97,87	STA LEL 42 CTA	71,11
6	6	S M14x1,5	LES 6 CTA	10,73	STA LES 6 CTA	8,43
8	8	S M16x1,5	LES 8 CTA	11,98	STA LES 8 CTA	9,41
10	10	S M18x1,5	LES 10 CTA	13,48	STA LES 10 CTA	10,44
12	12	S M20x1,5	LES 12 CTA	15,05	STA LES 12 CTA	11,54
14	14	S M22x1,5	LES 14 CTA	23,48	STA LES 14 CTA	17,99
16	16	S M24x1,5	LES 16 CTA	23,10	STA LES 16 CTA	16,98
20	20	S M30x2	LES 20 CTA	35,07	STA LES 20 CTA	25,69
25	25	S M36x2	LES 25 CTA	54,78	STA LES 25 CTA	38,51
30	30	S M42x2	LES 30 CTA	72,66	STA LES 30 CTA	51,72
38	38	S M52x2	LES 38 CTA	105,61	STA LES 38 CTA	76,13

## Racor en T regulable con tuerca y anillo

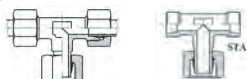

**Té Orientable tube lisse équipé au centre**  
**Adjustable stud branch TEE with nut and ring**  
**Raccordo orientabile a T con dado e anello centrale**

TUBO PIPE	S.	ROSCA THREAD	REFERENCIA PART N°	€	REFERENCIA STA PART N° STA	€
6	6	L M12x1,5	TEL 6 CTA	9,04	STA TEL 6 CTA	7,09
8	8	L M14x1,5	TEL 8 CTA	9,55	STA TEL 8 CTA	7,41
10	10	L M16x1,5	TEL 10 CTA	11,11	STA TEL 10 CTA	8,61
12	12	L M18x1,5	TEL 12 CTA	11,57	STA TEL 12 CTA	8,71
15	15	L M22x1,5	TEL 15 CTA	15,79	STA TEL 15 CTA	11,75
18	18	L M26x1,5	TEL 18 CTA	20,57	STA TEL 18 CTA	14,87
22	22	L M30x2	TEL 22 CTA	33,25	STA TEL 22 CTA	24,99
28	28	L M36x2	TEL 28 CTA	49,32	STA TEL 28 CTA	35,95
35	35	L M45x2	TEL 35 CTA	67,50	STA TEL 35 CTA	49,06
42	42	L M52x2	TEL 42 CTA	98,54	STA TEL 42 CTA	71,72
6	6	S M14x1,5	TES 6 CTA	10,61	STA TES 6 CTA	8,32
8	8	S M16x1,5	TES 8 CTA	11,63	STA TES 8 CTA	9,08
10	10	S M18x1,5	TES 10 CTA	13,02	STA TES 10 CTA	10,01
12	12	S M20x1,5	TES 12 CTA	14,92	STA TES 12 CTA	11,42
14	14	S M22x1,5	TES 14 CTA	22,82	STA TES 14 CTA	17,38
16	16	S M24x1,5	TES 16 CTA	21,22	STA TES 16 CTA	15,27
20	20	S M30x2	TES 20 CTA	35,65	STA TES 20 CTA	26,21
25	25	S M36x2	TES 25 CTA	54,35	STA TES 25 CTA	38,11
30	30	S M42x2	TES 30 CTA	71,16	STA TES 30 CTA	50,35
38	38	S M52x2	TES 38 CTA	104,28	STA TES 38 CTA	74,91

## Racor en codo tubo-TL Métrica



**Coude orientable Métrique + o'ring**  
**Adjustable stud elbow with o'ring**  
**Raccordo orientabile a 90° con o'ring**

TUBO PIPE	S.	ROSCA THREAD	REFERENCIA PART N°	€	REFERENCIA STA PART N° STA	€
6	6	L M12x1,5	EEL 6 TLM	6,70	STA EEL 6 TLM	5,54
8	8	L M14x1,5	EEL 8 TLM	6,73	STA EEL 8 TLM	5,50
10	10	L M16x1,5	EEL 10 TLM	7,42	STA EEL 10 TLM	6,01
12	12	L M18x1,5	EEL 12 TLM	10,13	STA EEL 12 TLM	15,94
15	15	L M22x1,5	EEL 15 TLM	10,59	STA EEL 15 TLM	8,34
18	18	L M26x1,5	EEL 18 TLM	14,85	STA EEL 18 TLM	11,62
22	22	L M30x2	EEL 22 TLM	20,38	STA EEL 22 TLM	15,94
28	28	L M36x2	EEL 28 TLM	31,34	STA EEL 28 TLM	24,09
35	35	L M45x2	EEL 35 TLM	46,42	STA EEL 35 TLM	36,14
42	42	L M52x2	EEL 42 TLM	68,89	STA EEL 42 TLM	53,83
6	6	S M14x1,5	EES 6 TLM	7,71	STA EES 6 TLM	6,37
8	8	S M16x1,5	EES 8 TLM	8,51	STA EES 8 TLM	7,02
10	10	S M18x1,5	EES 10 TLM	9,71	STA EES 10 TLM	7,94
12	12	S M20x1,5	EES 12 TLM	10,08	STA EES 12 TLM	8,12
14	14	S M22x1,5	EES 14 TLM	12,83	STA EES 14 TLM	11,59
16	16	S M24x1,5	EES 16 TLM	15,34	STA EES 16 TLM	11,96
20	20	S M30x2	EES 20 TLM	22,12	STA EES 20 TLM	17,04
25	25	S M36x2	EES 25 TLM	34,02	STA EES 25 TLM	25,32
30	30	S M42x2	EES 30 TLM	47,78	STA EES 30 TLM	36,34
38	38	S M52x2	EES 38 TLM	72,48		*

Por razones logísticas y de producción, estos productos se suministrarán según disponibilidad (Zn/Ni; CrIII; CrVI). Las referencias más estándar (equivalentes a la serie B, ver págs. (174-181), se suministrarán habitualmente en Zn/Ni. / Pour des raisons logistiques et de fabrication, les produits (Zn/Ni; CrIII; CrVI) seront fournis selon disponibilité. Les références standard, équivalentes à la série B, voir pages (174-181), seront fournies normalement en Zn/Ni. / For logistics and manufacturing reasons, products (Zn/Ni; CrIII; CrVI) will be supplied upon availability. Standard references, equivalent to B series, see pages (174-181), will, usually, be supplied in Zn/Ni. / Per ragioni di logistica e di produzione, questi articoli saranno forniti secondo la disponibilità (Zn/Ni; CrIII; CrVI) I codici più standard (equivalenti alla serie B, vedere pagine (174-181), saranno forniti abitualmente in Zn/Ni.

# Racores DIN 2353

Raccords à bague DIN 2353  
DIN 2353 Pipe fittings  
Raccordi ad anello DIN 2353

## Racor en T tubo-TL Métrica

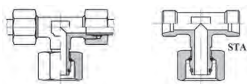

**Té Orientable Métrique + o'ring**  
Adjustable stud branch TEE with o'ring  
Raccordo orientabile a T con o'ring centrale

TUBO PIPE	S.	ROSCA THREAD	REFERENCIA PART N°	€	REFERENCIA STA PART N° STA	€	
6	6	L	M12x1,5	TEL 6 TLM	10,70	STA TEL 6 TLM	8,61
8	8	L	M14x1,5	TEL 8 TLM	11,18	STA TEL 8 TLM	8,90
10	10	L	M16x1,5	TEL 10 TLM	12,72	STA TEL 10 TLM	10,08
12	12	L	M18x1,5	TEL 12 TLM	13,24	STA TEL 12 TLM	10,23
15	15	L	M22x1,5	TEL 15 TLM	17,56	STA TEL 15 TLM	13,37
18	18	L	M26x1,5	TEL 18 TLM	23,13	STA TEL 18 TLM	17,22
22	22	L	M30x2	TEL 22 TLM	35,99	STA TEL 22 TLM	27,50
28	28	L	M36x2	TEL 28 TLM	53,20	STA TEL 28 TLM	39,51
35	35	L	M45x2	TEL 35 TLM	71,15	STA TEL 35 TLM	52,40
42	42	L	M52x2	TEL 42 TLM	112,28	STA TEL 42 TLM	84,31
6	6	S	M14x1,5	TES 6 TLM	12,33	STA TES 6 TLM	9,90
8	8	S	M16x1,5	TES 8 TLM	13,64	STA TES 8 TLM	10,94
10	10	S	M18x1,5	TES 10 TLM	14,99	STA TES 10 TLM	11,82
12	12	S	M20x1,5	TES 12 TLM	16,94	STA TES 12 TLM	13,27
14	14	S	M22x1,5	TES 14 TLM	51,27	STA TES 14 TLM	43,44
16	16	S	M24x1,5	TES 16 TLM	24,18	STA TES 16 TLM	17,98
20	20	S	M30x2	TES 20 TLM	38,63	STA TES 20 TLM	28,94
25	25	S	M36x2	TES 25 TLM	58,18	STA TES 25 TLM	41,62
30	30	S	M42x2	TES 30 TLM	74,03	STA TES 30 TLM	52,98
38	38	S	M52x2	TES 38 TLM	117,46	STA TES 38 TLM	86,98

## Racor en L tubo-TL Métrica

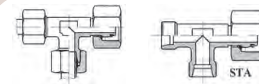

**L Orientable renversé Métrique + o'ring**  
Adjustable stud barrel L with o'ring  
Raccordo orientabile a T con o'ring laterale

TUBO PIPE	S.	ROSCA THREAD	REFERENCIA PART N°	€	REFERENCIA STA PART N° STA	€	
6	6	L	M12x1,5	LEL 6 TLM	10,96	STA LEL 6 TLM	8,85
8	8	L	M14x1,5	LEL 8 TLM	11,10	STA LEL 8 TLM	8,82
10	10	L	M16x1,5	LEL 10 TLM	12,23	STA LEL 10 TLM	9,63
12	12	L	M18x1,5	LEL 12 TLM	13,69	STA LEL 12 TLM	10,65
15	15	L	M22x1,5	LEL 15 TLM	18,01	STA LEL 15 TLM	13,78
18	18	L	M26x1,5	LEL 18 TLM	23,91	STA LEL 18 TLM	17,93
22	22	L	M30x2	LEL 22 TLM	35,13	STA LEL 22 TLM	26,71
28	28	L	M36x2	LEL 28 TLM	52,87	STA LEL 28 TLM	39,21
35	35	L	M45x2	LEL 35 TLM	72,39	STA LEL 35 TLM	53,54
42	42	L	M52x2	LEL 42 TLM	111,97	STA LEL 42 TLM	84,03
6	6	S	M14x1,5	LES 6 TLM	12,53	STA LES 6 TLM	10,08
8	8	S	M16x1,5	LES 8 TLM	12,56	STA LES 8 TLM	9,93
10	10	S	M18x1,5	LES 10 TLM	15,47	STA LES 10 TLM	12,26
12	12	S	M20x1,5	LES 12 TLM	17,11	STA LES 12 TLM	13,43
14	14	S	M22x1,5	LES 14 TLM	26,10	STA LES 14 TLM	20,39
16	16	S	M24x1,5	LES 16 TLM	26,05	STA LES 16 TLM	19,69
20	20	S	M30x2	LES 20 TLM	38,40	STA LES 20 TLM	28,74
25	25	S	M36x2	LES 25 TLM	58,63	STA LES 25 TLM	42,04
30	30	S	M42x2	LES 30 TLM	75,50	STA LES 30 TLM	54,32
38	38	S	M52x2	LES 38 TLM	120,30	STA LES 38 TLM	89,58

## Racor unión TL-TL Métrica

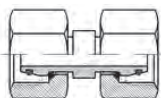

**Union tournante Métrique égale**  
Straight connection with o'ring  
Raccordo di estremità diritto Metrico con o'ring

TUBO PIPE	SERIE	REFERENCIA PART N°	€
6	L	ATL 6	9,34
8	L	ATL 8	10,04
10	L	ATL 10	10,41
12	L	ATL 12	11,16
15	L	ATL 15	12,50
18	L	ATL 18	13,74
22	L	ATL 22	15,68
28	L	ATL 28	23,54
35	L	ATL 35	27,86
42	L	ATL 42	33,82
6	S	ATS 6	11,24
8	S	ATS 8	12,05
10	S	ATS 10	12,37
12	S	ATS 12	13,29
14	S	ATS 14	16,75
20	S	ATS 20	18,36
25	S	ATS 25	23,52
30	S	ATS 30	34,40
38	S	ATS 38	38,63

## Tubo roscado recto métrico TLM

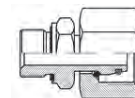

**Adaptateur tube lisse x mâle met.a/écrou Met.+o'ring**  
Straight stud metric standpipe adpt.w/captive seal-o'ring Met. cyl  
Adattatore diritto Metrico TLM

TUBO PIPE	SERIE	ROSCA THREAD	REFERENCIA PART N°	€
6	L	M10X1	RAL 6 TLM M 10X1	5,26
8	L	M12X1,5	RAL 8 TLM M 12X1,5	5,40
10	L	M14X1,5	RAL 10 TLM M 14X1,5	5,60
12	L	M16X1,5	RAL 12 TLM M 16X1,5	6,15
15	L	M18X1,5	RAL 15 TLM M 18X1,5	7,30
18	L	M22X1,5	RAL 18 TLM M 22X1,5	8,27
22	L	M26X1,5	RAL 22 TLM M 26X1,5	12,49
28	L	M33X2	RAL 28 TLM M 33X2	20,45
35	L	M42X2	RAL 35 TLM M 42X2	31,11
42	L	M48X2	RAL 42 TLM M 48X2	35,52
6	S	M12X1,5	RAS 6 TLM M 12X1,5	6,18
8	S	M14X1,5	RAS 8 TLM M 14X1,5	6,38
10	S	M16X1,5	RAS 10 TLM M 16X1,5	6,55
12	S	M18X1,5	RAS 12 TLM M 18X1,5	6,84
14	S	M20X1,5	RAS 14 TLM M 20X1,5	13,32
16	S	M22X1,5	RAS 16 TLM M 22X1,5	9,24
20	S	M27X2	RAS 20 TLM M 27X2	14,02
25	S	M33X2	RAS 25 TLM M 33X2	21,64
30	S	M42X2	RAS 30 TLM M 42X2	32,40
38	S	M48X2	RAS 38 TLM M 48X2	48,07

Por razones logísticas y de producción, estos productos se suministrarán según disponibilidad (Zn/Ni; CrIII; CrVI). Las referencias más estándar (equivalentes a la serie B, ver págs. (174-181), se suministrarán habitualmente en Zn/Ni. / Pour des raisons logistiques et de fabrication, les produits (Zn/Ni; CrIII; CrVI) seront fournis selon disponibilité. Les références standard, équivalentes à la série B, voir pages (174-181), seront fournies normalement en Zn/Ni. / For logistics and manufacturing reasons, products (Zn/Ni; CrIII; CrVI) will be supplied upon availability. Standard references, equivalent to B series, see pages (174-181), will, usually, be supplied in Zn/Ni. / Per ragioni di logistica e di produzione, questi articoli saranno forniti secondo la disponibilità (Zn/Ni; CrIII; CrVI) I codici più standard (equivalenti alla serie B, vedere pagine (174-181), saranno forniti abitualmente in Zn/Ni.

\* Consultar | Sur demande | On request | Su richiesta

## Racores DIN 2353

Raccords à bague DIN 2353  
DIN 2353 Pipe fittings  
Raccordi ad anello DIN 2353

Pipe

DIN 2353 Pipe Fittings

Gas tube fittings

JIC 37° fittings

SAE Flanges

Clamps

Machines for  
processing rigid pipes

### Tubo rosca Métrica con tuerca y anillo

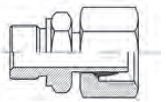

Adapteur tube lisse x mâle Métrique avec écrou et bague  
Straight stud standpipe adaptor Metric cyl with nut and ring  
Adattatore diritto Metrico cilindrico con guarnizione

TUBO PIPE	SERIE	ROSCA THREAD	REFERENCIA PART N°	€
6	L	M10X1	<b>RAL 6 M 10X1 CTA</b>	<b>3,91</b>
8	L	M12X1.5	<b>RAL 8 M 12X1.5 CTA</b>	<b>4,07</b>
10	L	M14X1.5	<b>RAL 10 M 14X1.5 CTA</b>	<b>4,55</b>
12	L	M16X1.5	<b>RAL 12 M 16X1.5 CTA</b>	<b>5,23</b>
15	L	M18X1.5	<b>RAL 15 M 18X1.5 CTA</b>	<b>6,50</b>
18	L	M22X1.5	<b>RAL 18 M 22X1.5 CTA</b>	<b>8,33</b>
22	L	M26X1.5	<b>RAL 22 M 26X1.5 CTA</b>	<b>13,21</b>
28	L	M33X2	<b>RAL 28 M 33X2 CTA</b>	<b>20,42</b>
35	L	M42X2	<b>RAL 35 M 42X2 CTA</b>	<b>31,95</b>
42	L	M48X2	<b>RAL 42 M 48X2 CTA</b>	<b>41,30</b>
6	S	M12X1.5	<b>RAS 6 M 12X1.5 CTA</b>	<b>4,73</b>
8	S	M14X1.5	<b>RAS 8 M 14X1.5 CTA</b>	<b>5,92</b>
10	S	M16X1.5	<b>RAS 10 M 16X1.5 CTA</b>	<b>5,57</b>
12	S	M18X1.5	<b>RAS 12 M 18X1.5 CTA</b>	<b>6,08</b>
14	S	M20X1.5	<b>RAS 14 M 20X1.5 CTA</b>	<b>15,76</b>
16	S	M22X1.5	<b>RAS 16 M 22X1.5 CTA</b>	<b>13,69</b>
20	S	M27X2	<b>RAS 20 M 27X2 CTA</b>	<b>24,37</b>
25	S	M33X2	<b>RAS 25 M 33X2 CTA</b>	<b>22,46</b>
30	S	M42X2	<b>RAS 30 M 42X2 CTA</b>	<b>33,08</b>
38	S	M48X2	<b>RAS 38 M 48X2 CTA</b>	<b>50,65</b>

### Tubo roscado recto BSP TLM

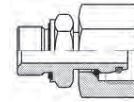

Adapteur tube lisse x mâle gaz a/écrou+o'ring  
Straight stud standpipe adpt. w/captive seal&o'ring BSP cyl  
Adattatore diritto BSP TLM

TUBO PIPE	SERIE	ROSCA THREAD	REFERENCIA PART N°	€
6	L	1/8"BSP	<b>RAL 6 TLM R 1/8</b>	<b>4,61</b>
8	L	1/4"BSP	<b>RAL 8 TLM R 1/4</b>	<b>4,84</b>
10	L	1/4"BSP	<b>RAL 10 TLM R 1/4</b>	<b>5,02</b>
12	L	3/8 BSP	<b>RAL 12 TLM R 3/8</b>	<b>5,20</b>
15	L	1/2"BSP	<b>RAL 15 TLM R 1/2</b>	<b>6,93</b>
18	L	1/2"BSP	<b>RAL 18 TLM R 1/2</b>	<b>7,83</b>
22	L	3/4"BSP	<b>RAL 22 TLM R 3/4</b>	<b>11,66</b>
28	L	1"BSP	<b>RAL 28 TLM R 1</b>	<b>17,16</b>
35	L	1" 1/4 BSP	<b>RAL 35 TLM R 1 1/4</b>	<b>29,89</b>
42	L	1" 1/2 BSP	<b>RAL 42 TLM R 1 1/2</b>	<b>32,95</b>
6	S	1/4"BSP	<b>RAS 6 TLM R 1/4</b>	<b>5,29</b>
8	S	1/4"BSP	<b>RAS 8 TLM R 1/4</b>	<b>5,37</b>
10	S	3/8"BSP	<b>RAS 10 TLM R 3/8</b>	<b>5,47</b>
12	S	3/8"BSP	<b>RAS 12 TLM R 3/8</b>	<b>5,62</b>
14	S	1/2"BSP	<b>RAS 14 TLM R 1/2</b>	<b>11,03</b>
16	S	1/2"BSP	<b>RAS 16 TLM R 1/2</b>	<b>8,63</b>
20	S	3/4"BSP	<b>RAS 20 TLM R 3/4</b>	<b>12,70</b>
25	S	1"BSP	<b>RAS 25 TLM R 1</b>	<b>18,36</b>
30	S	1" 1/4 BSP	<b>RAS 30 TLM R 1 1/4</b>	<b>27,92</b>
38	S	1" 1/2 BSP	<b>RAS 38 TLM R 1 1/2</b>	<b>43,28</b>

### Tubo roscado recto BSP con tuerca y anillo

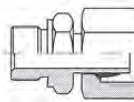

Adapteur tube lisse x mâle gaz + o'ring (avec écrou et bague)  
Straight stud standpipe adaptor with captive seal BSP cyl with nut and ring  
Adattatore diritto BSP cilindrico con guarnizione

TUBO PIPE	SERIE	ROSCA THREAD	REFERENCIA PART N°	€
6	L	1/8"BSP	<b>RAL 6 R 1/8 CTA</b>	<b>3,63</b>
8	L	1/4"BSP	<b>RAL 8 R 1/4 CTA</b>	<b>4,07</b>
10	L	1/4"BSP	<b>RAL 10 R 1/4 CTA</b>	<b>4,21</b>
12	L	3/8"BSP	<b>RAL 12 R 3/8 CTA</b>	<b>4,61</b>
15	L	1/2"BSP	<b>RAL 15 R 1/2 CTA</b>	<b>6,40</b>
18	L	1/2"BSP	<b>RAL 18 R 1/2 CTA</b>	<b>8,14</b>
22	L	3/4"BSP	<b>RAL 22 R 3/4 CTA</b>	<b>12,06</b>
28	L	1"BSP	<b>RAL 28 R 1 CTA</b>	<b>18,86</b>
35	L	1" 1/4 BSP	<b>RAL 35 R 1 1/4 CTA</b>	<b>31,63</b>
6	S	1/4"BSP	<b>RAS 6 R 1/4 CTA</b>	<b>4,07</b>
8	S	1/4"BSP	<b>RAS 8 R 1/4 CTA</b>	<b>4,17</b>
10	S	3/8"BSP	<b>RAS 10 R 3/8 CTA</b>	<b>4,57</b>
12	S	3/8"BSP	<b>RAS 12 R 3/8 CTA</b>	<b>4,80</b>
14	S	1/2"BSP	<b>RAS 14 R 1/2 CTA</b>	<b>9,42</b>
16	S	1/2"BSP	<b>RAS 16 R 1/2 CTA</b>	<b>8,53</b>
20	S	3/4"BSP	<b>RAS 20 R 3/4 CTA</b>	<b>13,91</b>
25	S	1"BSP	<b>RAS 25 R 1 CTA</b>	<b>21,40</b>
30	S	1" 1/4 BSP	<b>RAS 30 R 1 1/4 CTA</b>	<b>30,08</b>
38	S	1" 1/2 BSP	<b>RAS 38 R 1 1/2 CTA</b>	<b>46,13</b>

Por razones logísticas y de producción, estos productos se suministrarán según disponibilidad (Zn/Ni; CrIII; CrVI). Las referencias más estándar (equivalentes a la serie B, ver págs. (174-181), se suministrarán habitualmente en Zn/Ni. / Pour des raisons logistiques et de fabrication, les produits (Zn/Ni; CrIII; CrVI) seront fournis selon disponibilité. Les références standard, équivalentes à la série B, voir pages (174-181), seront fournies normalement en Zn/Ni. / For logistics and manufacturing reasons, products (Zn/Ni; CrIII; CrVI) will be supplied upon availability. Standard references, equivalent to B series, see pages (174-181), will, usually, be supplied in Zn/Ni. / Per ragioni di logistica e di produzione, questi articoli saranno forniti secondo la disponibilità (Zn/Ni; CrIII; CrVI) I codici più standard (equivalenti alla serie B, vedere pagine (174-181), saranno forniti abitualmente in Zn/Ni.

# Racores DIN 2353

Raccords à bague DIN 2353  
DIN 2353 Pipe fittings  
Raccordi ad anello DIN 2353

## Racor recto para soldar

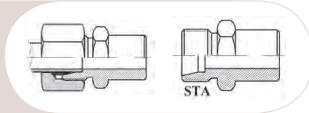

Mamelon hexagonal à souder Métrique (DIN 2353) équipé avec bague et écrou

Weldable straight coupling  
Raccordo diritto a saldare

TUBO PIPE	SERIE	REFERENCIA PART N°	€	REFERENCIA STA PART N° STA	€
6	L	ASL 6	4,54	STA ASL 6	3,56
8	L	ASL 8	3,92	STA ASL 8	2,92
10	L	ASL 10	4,20	STA ASL 10	3,06
12	L	ASL 12	5,24	STA ASL 12	3,85
15	L	ASL 15	5,95	STA ASL 15	4,09
18	L	ASL 18	7,46	STA ASL 18	4,85
22	L	ASL 22	10,00	STA ASL 22	6,43
28	L	ASL 28	15,02	STA ASL 28	9,15
35	L	ASL 35	21,39	STA ASL 35	13,20
42	L	ASL 42	31,02	STA ASL 42	19,15
6	S	ASS 6	4,76	STA ASS 6	3,67
8	S	ASS 8	5,28	STA ASS 8	4,05
10	S	ASS 10	4,55	STA ASS 10	3,21
12	S	ASS 12	5,89	STA ASS 12	4,28
14	S	ASS 14	6,88	STA ASS 14	4,55
16	S	ASS 16	7,45	STA ASS 16	4,74
20	S	ASS 20	9,85	STA ASS 20	6,76
25	S	ASS 25	16,14	STA ASS 25	8,95
30	S	ASS 30	22,87	STA ASS 30	13,54
38	S	ASS 38	33,55	STA ASS 38	20,44

## Boquilla para soldar

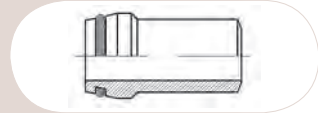

Collet cône Métrique (DIN 2353) à souder (BW) o'ring

Welding nipple  
Ogiva a saldare

TUBO PIPE	SERIE	REFERENCIA PART N°	€
8	S	ORIS 8X1.5	3,48
10	S	ORIS 10X2	3,48
12	S	ORIS 12X1.5	3,73
12	S	ORIS 12X2.5	3,73
14	S	ORIS 14X2	4,51
14	S	ORIS 14X3	4,51
16	S	ORIS 16X2	4,45
16	S	ORIS 16X2.5	4,45
16	S	ORIS 16X3	4,45
20	S	ORIS 20X2.5	5,45
20	S	ORIS 20X3	5,45
20	S	ORIS 20X4	5,45
25	S	ORIS 25X4	6,80
30	S	ORIS 30X4	8,95
30	S	ORIS 30X5	8,95
38	S	ORIS 38X5	12,58

## Racor pasatabique para soldar



Union double passe cloison Métrique à souder

Weldable bulkhead coupling  
Raccordo passaparete a saldare

TUBO PIPE	SERIE	REFERENCIA PART N°	€	REFERENCIA STA PART N° STA	€
6	L	ESVL 6	13,06	STA ESVL 6	10,77
8	L	ESVL 8	13,32	STA ESVL 8	10,86
10	L	ESVL 10	10,53	STA ESVL 10	9,49
12	L	ESVL 12	13,70	STA ESVL 12	12,29
15	L	ESVL 15	14,52	STA ESVL 15	12,70
18	L	ESVL 18	21,83	STA ESVL 18	16,02
22	L	ESVL 22	28,67	STA ESVL 22	20,80
28	L	ESVL 28	33,24	STA ESVL 28	24,87
35	L	ESVL 35	51,48	STA ESVL 35	34,39
42	L	ESVL 42	79,05	STA ESVL 42	53,88
6	S	ESVS 6	13,55	STA ESVS 6	11,02
8	S	ESVS 8	14,48	STA ESVS 8	11,70
10	S	ESVS 10	15,73	STA ESVS 10	12,50
12	S	ESVS 12	16,44	STA ESVS 12	12,82
16	S	ESVS 16	23,91	STA ESVS 16	17,73
20	S	ESVS 20	30,86	STA ESVS 20	21,83
25	S	ESVS 25	41,72	STA ESVS 25	26,55
30	S	ESVS 30	52,68	STA ESVS 30	33,42
38	S	ESVS 38	80,60	STA ESVS 38	53,23

Por razones logísticas y de producción, estos productos se suministrarán según disponibilidad (Zn/Ni; CrIII; CrVI). Las referencias más estándar (equivalentes a la serie B, ver págs. (174-181), se suministrarán habitualmente en Zn/Ni. / Pour des raisons logistiques et de fabrication, les produits (Zn/Ni; CrIII; CrVI) seront fournis selon disponibilité. Les références standard, équivalentes à la série B, voir pages (174-181), seront fournies normalement en Zn/Ni. / For logistics and manufacturing reasons, products (Zn/Ni; CrIII; CrVI) will be supplied upon availability. Standard references, equivalent to B series, see pages (174-181), will, usually, be supplied in Zn/Ni. / Per ragioni di logistica e di produzione, questi articoli saranno forniti secondo la disponibilità (Zn/Ni; CrIII; CrVI) I codici più standard (equivalenti alla serie B, vedere pagine (174-181), saranno forniti abitualmente in Zn/Ni.

## Racores DIN 2353

Raccords à bague DIN 2353  
DIN 2353 Pipe fittings  
Raccordi ad anello DIN 2353

Pipe

DIN 2353 Pipe Fittings

Gas tube fittings

JIC 37° fittings

SAE Flanges

Clamps

Machines for processing rigid pipes

### Racor recto pasatabiques con tuerca



Union double passe cloison  
Straight bulkhead coupling  
Raccordo passaparete

TUBO PIPE	S.	REF. PART N°	€	REFERENCIA STA PART N° STA	€
6	6	L SVL 6	4,33	STA SVL 6	2,78
8	8	L SVL 8	4,51	STA SVL 8	2,79
10	10	L SVL 10	5,60	STA SVL 10	3,95
12	12	L SVL 12	6,41	STA SVL 12	3,99
15	15	L SVL 15	9,94	STA SVL 15	6,40
18	18	L SVL 18	15,36	STA SVL 18	10,09
22	22	L SVL 22	19,77	STA SVL 22	12,65
28	28	L SVL 28	30,09	STA SVL 28	18,35
35	35	L SVL 35	47,49	STA SVL 35	30,74
42	42	L SVL 42	67,19	STA SVL 42	43,02
6	6	S SVS 6	5,87	STA SVS 6	3,99
8	8	S SVS 8	6,47	STA SVS 8	4,36
10	10	S SVS 10	7,37	STA SVS 10	4,85
12	12	S SVS 12	9,70	STA SVS 12	6,65
14	14	S SVS 14	16,95	STA SVS 14	12,01
16	16	S SVS 16	15,49	STA SVS 16	10,02
20	20	S SVS 20	24,41	STA SVS 20	15,92
25	25	S SVS 25	39,81	STA SVS 25	24,80
30	30	S SVS 30	49,65	STA SVS 30	30,64
38	38	S SVS 38	78,68	STA SVS 38	51,46

### Racor en codo pasatabiques con tuerca

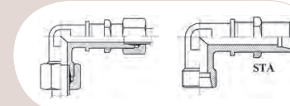

Coude égal passe cloison  
Elbow bulkhead coupling  
Raccordo passaparete a 90°

TUBO PIPE	S.	REFERENCIA PART N°	€	REFERENCIA STA PART N° STA	€
6	6	L USVL 6	8,72	STA USVL 6	6,80
8	8	L USVL 8	9,12	STA USVL 8	7,02
10	10	L USVL 10	10,17	STA USVL 10	7,74
12	12	L USVL 12	12,49	STA USVL 12	9,55
15	15	L USVL 15	15,02	STA USVL 15	11,05
18	18	L USVL 18	20,72	STA USVL 18	15,01
22	22	L USVL 22	32,82	STA USVL 22	24,60
28	28	L USVL 28	50,51	STA USVL 28	37,05
35	35	L USVL 35	76,12	STA USVL 35	56,95
42	42	L USVL 42	112,54	STA USVL 42	84,55
8	8	S USVS 8	11,51	STA USVS 8	8,98
10	10	S USVS 10	14,33	STA USVS 10	11,22
12	12	S USVS 12	14,82	STA USVS 12	11,33
14	14	S USVS 14	25,81	STA USVS 14	20,12
16	16	S USVS 16	20,96	STA USVS 16	15,03
20	20	S USVS 20	33,52	STA USVS 20	24,26
25	25	S USVS 25	55,17	STA USVS 25	38,86
30	30	S USVS 30	75,47	STA USVS 30	54,29
38	38	S USVS 38	113,65	STA USVS 38	83,49

Por razones logísticas y de producción, estos productos se suministrarán según disponibilidad (Zn/Ni; CrIII; CrVI). Las referencias más estándar (equivalentes a la serie B, ver págs. (174-181), se suministrarán habitualmente en Zn/Ni. / Pour des raisons logistiques et de fabrication, les produits (Zn/Ni; CrIII; CrVI) seront fournis selon disponibilité. Les références standard, équivalentes à la série B, voir pages (174-181), seront fournies normalement en Zn/Ni. / For logistics and manufacturing reasons, products (Zn/Ni; CrIII; CrVI) will be supplied upon availability. Standard references, equivalent to B series, see pages (174-181), will, usually, be supplied in Zn/Ni. / Per ragioni di logistica e di produzione, questi articoli saranno forniti secondo la disponibilità (Zn/Ni; CrIII; CrVI) I codici più standard (equivalenti alla serie B, vedere pagine (174-181), saranno forniti abitualmente in Zn/Ni.



# Racores DIN 2353

Raccords à bague DIN 2353  
DIN 2353 Pipe fittings  
Raccordi ad anello DIN 2353

## Racor recto hembra rosca BSP

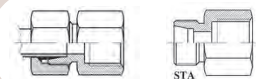

Union simple femelle gaz  
Female stud coupling  
Raccordo diritto femmina BSP

T. P.	S.	ROSCA THREAD	REFERENCIA PART N°	€	REFERENCIA STA PART N° STA	€
6	L	1/8" BSP	GAIL 6 R 1/8	2,57	STA GAIL 6 R 1/8	1,76
8	L	1/4" BSP	GAIL 8 R 1/4	2,80	STA GAIL 8 R 1/4	1,89
10	L	1/4" BSP	GAIL 10 R 1/4	3,07	STA GAIL 10 R 1/4	2,03
10	L	3/8" BSP	GAIL 10 R 3/8	15,96	STA GAIL 10 R 3/8	13,83
10	L	1/2" BSP	GAIL 10 R 1/2	21,94	STA GAIL 10 R 1/2	19,31
12	L	3/8" BSP	GAIL 12 R 3/8	3,76	STA GAIL 12 R 3/8	2,50
12	L	1/2" BSP	GAIL 12 R 1/2	13,38	STA GAIL 12 R 1/2	11,31
15	L	1/2" BSP	GAIL 15 R 1/2	5,32	STA GAIL 15 R 1/2	3,52
18	L	1/2" BSP	GAIL 18 R 1/2	6,73	STA GAIL 18 R 1/2	4,18
22	L	3/4" BSP	GAIL 22 R 3/4	10,06	STA GAIL 22 R 3/4	6,48
28	L	1" BSP	GAIL 28 R 1	26,10	STA GAIL 28 R 1	19,29
35	L	1 1/4" BSP	GAIL 35 R 1 1/4	41,28	STA GAIL 35 R 1 1/4	31,42
42	L	1 1/2" BSP	GAIL 42 R 1 1/2	47,45	STA GAIL 42 R 1 1/2	34,20
6	S	1/4" BSP	GAIS 6 R 1/4	5,23	STA GAIS 6 R 1/4	4,09
8	S	1/4" BSP	GAIS 8 R 1/4	5,38	STA GAIS 8 R 1/4	4,15
10	S	3/8" BSP	GAIS 10 R 3/8	7,35	STA GAIS 10 R 3/8	5,78
14	S	1/2" BSP	GAIS 14 R 1/2	14,04	STA GAIS 14 R 1/2	11,10
16	S	1/2" BSP	GAIS 16 R 1/2	9,34	STA GAIS 16 R 1/2	6,47
20	S	3/4" BSP	GAIS 20 R 3/4	15,76	STA GAIS 20 R 3/4	11,22
25	S	1" BSP	GAIS 25 R 1	31,19	STA GAIS 25 R 1	22,73
30	S	1 1/4" BSP	GAIS 30 R 1 1/4	42,50	STA GAIS 30 R 1 1/4	31,51
38	S	1 1/2" BSP	GAIS 38 R 1 1/2	50,36	STA GAIS 38 R 1 1/2	35,83

## Racor recto hembra rosca Métrica



Union simple femelle Métrique  
Female stud coupling Metric cyl  
Raccordo diritto femmina Metrico

T. P.	S.	ROSCA THREAD	REFERENCIA PART N°	€	REFERENCIA STA PART N° STA	€
6	L	M10x1	GAIL 6 M 10X1	7,94	STA GAIL 6 M 10X1	6,68
8	L	M12x1,5	GAIL 8 M 12X1.5	9,30	STA GAIL 8 M 12X1.5	7,84
10	L	M14x1,5	GAIL 10 M 14X1.5	9,84	STA GAIL 10 M 14X1.5	8,23
12	L	M16x1,5	GAIL 12 M 16X1.5	12,12	STA GAIL 12 M 16X1.5	10,16
15	L	M18x1,5	GAIL 15 M 18X1.5	12,48	STA GAIL 15 M 18X1.5	10,08
18	L	M22x1,5	GAIL 18 M 22X1.5	15,27	STA GAIL 18 M 22X1.5	12,00
22	L	M26x1,5	GAIL 22 M 26X1.5	19,62	STA GAIL 22 M 26X1.5	15,24
6	S	M12x1,5	GAIS 6 M 12X1.5	10,67	STA GAIS 6 M 12X1.5	9,08
8	S	M14x1,5	GAIS 8 M 14X1.5	11,90	STA GAIS 8 M 14X1.5	10,11
10	S	M16x1,5	GAIS 10 M 16X1.5	12,99	STA GAIS 10 M 16X1.5	13,06
12	S	M18x1,5	GAIS 12 M 18X1.5	15,29	STA GAIS 12 M 18X1.5	12,89
14	S	M20x1,5	GAIS 14 M 20X1.5	24,38	STA GAIS 14 M 20X1.5	20,57
20	S	M27x2	GAIS 20 M 27X2	26,76	STA GAIS 20 M 27X2	21,29

## Racor para manómetro BSP



Union pour manomètre gaz  
Gauge coupling BSP cyl  
Raccordo per manometri BSP

TUBO PIPE	SERIE	ROSCA THREAD	REFERENCIA PART N°	€
6	L	1/4" BSP	MAVL 6 R 1/4	3,67
8	L	1/4" BSP	MAVL 8 R 1/4	3,74
10	L	1/4" BSP	MAVL 10 R 1/4	4,17
12	L	1/4" BSP	MAVL 12 R 1/4	4,56
6	S	1/2" BSP	MAVS 6 R 1/2	6,64
8	S	1/2" BSP	MAVS 8 R 1/2	6,78
10	S	1/2" BSP	MAVS 10 R 1/2	7,04
12	S	1/2" BSP	MAVS 12 R 1/2	7,24

## Arandela para manómetros

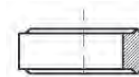

Bague pour manomètres  
Seal for gauge coupling  
Guarnizioni per manometri

ROSCA THREAD	REFERENCIA PART N°	€
1/4" BSP	AM 1/4	1,35
1/2" BSP	AM 1/2	1,39

Por razones logísticas y de producción, estos productos se suministrarán según disponibilidad (Zn/Ni; CrIII; CrVI). Las referencias más estándar (equivalentes a la serie B, ver págs. (174-181), se suministrarán habitualmente en Zn/Ni. / Pour des raisons logistiques et de fabrication, les produits (Zn/Ni; CrIII; CrVI) seront fournis selon disponibilité. Les références standard, équivalentes à la série B, voir pages (174-181), seront fournies normalement en Zn/Ni. / For logistics and manufacturing reasons, products (Zn/Ni; CrIII; CrVI) will be supplied upon availability. Standard references, equivalent to B series, see pages (174-181), will, usually, be supplied in Zn/Ni. / Per ragioni di logistica e di produzione, questi articoli saranno forniti secondo la disponibilità (Zn/Ni; CrIII; CrVI) I codici più standard (equivalenti alla serie B, vedere pagine (174-181), saranno forniti abitualmente in Zn/Ni.

## Racores DIN 2353

Raccords à bague DIN 2353  
DIN 2353 Pipe fittings  
Raccordi ad anello DIN 2353

Pipe

DIN 2353 Pipe Fittings

Gas tube fittings

JIC 37° fittings

SAE Flanges

Clamps

Machines for processing rigid pipes

### Racor en codo orientable sin estrangulador rosca BSP



Equerre orientable sans étrangleur gaz BSP (passage total)  
Banjo coupling with captive seal and o-ring BSP cyl  
Raccordo orientabile a 90° ad occhio BSP con guarnizione

T. P.	S.	ROSCA THREAD	REFERENCIA PART N°	€	REFERENCIA STA PART N° STA	€
4	LL	1/8" BSP	WSVLL 4 R 1/8	12,17	STA WSVLL 4 R 1/8	10,55
6	LL	1/8" BSP	WSVLL 6 R 1/8	11,95	STA WSVLL 6 R 1/8	10,33
8	LL	1/8" BSP	WSVLL 8 R 1/8	12,03	STA WSVLL 8 R 1/8	10,38
6	L	1/8" BSP	WSVL 6 R 1/8	13,11	STA WSVL 6 R 1/8	11,41
8	L	1/4" BSP	WSVL 8 R 1/4	13,91	STA WSVL 8 R 1/4	14,42
10	L	1/4" BSP	WSVL 10 R 1/4	14,24	STA WSVL 10 R 1/4	6,22
12	L	3/8" BSP	WSVL 12 R 3/8	18,07	STA WSVL 12 R 3/8	8,02
15	L	1/2" BSP	WSVL 15 R 1/2	22,29	STA WSVL 15 R 1/2	22,77
18	L	1/2" BSP	WSVL 18 R 1/2	28,93	STA WSVL 18 R 1/2	24,51
22	L	3/4" BSP	WSVL 22 R 3/4	44,82	STA WSVL 22 R 3/4	38,31
28	L	1" BSP	WSVL 28 R 1	71,10	STA WSVL 28 R 1	60,51
35	L	1 1/4" BSP	WSVL 35 R 1 1/4	107,58	STA WSVL 35 R 1 1/4	92,14
42	L	1 1/2" BSP	WSVL 42 R 1 1/2	144,08	STA WSVL 42 R 1 1/2	122,69
6	S	1/4" BSP	WSVS 6 R 1/4	14,21	STA WSVS 6 R 1/4	12,32
8	S	1/4" BSP	WSVS 8 R 1/4	14,78	STA WSVS 8 R 1/4	12,75
10	S	3/8" BSP	WSVS 10 R 3/8	18,81	STA WSVS 10 R 3/8	16,28
12	S	3/8" BSP	WSVS 12 R 3/8	19,04	STA WSVS 12 R 3/8	16,32
14	S	1/2" BSP	WSVS 14 R 1/2	25,70	STA WSVS 14 R 1/2	21,78
16	S	1/2" BSP	WSVS 16 R 1/2	28,98	STA WSVS 16 R 1/2	17,30
20	S	3/4" BSP	WSVS 20 R 3/4	46,67	STA WSVS 20 R 3/4	24,03
25	S	1" BSP	WSVS 25 R 1	72,99	STA WSVS 25 R 1	61,01
30	S	1 1/4" BSP	WSVS 30 R 1 1/4	112,38	STA WSVS 30 R 1 1/4	95,51
38	S	1 1/2" BSP	WSVS 38 R 1 1/2	128,83	STA WSVS 38 R 1 1/2	127,44

### Racor en codo orientable sin estrangulador rosca Métrica



Equerre orientable sans étrangleur métrique (passage total)  
Banjo coupling with captive seal and o'ring metric cyl  
Raccordo orientabile a 90° ad occhio Metrico con guarnizione

T. P.	S.	ROSCA THREAD	REFERENCIA PART N°	€	REFERENCIA STA PART N° STA	€
6	LL	M10X1	WSVLL 6 M 10X1	12,09	STA WSVLL 6 M 10X1	10,46
8	LL	M10X1	WSVLL 8 M 10X1	12,18	STA WSVLL 8 M 10X1	10,52
6	L	M10X1	WSVL 6 M 10X1	13,12	STA WSVL 6 M 10X1	11,42
8	L	M12X1.5	WSVL 8 M 12X1.5	13,99	STA WSVL 8 M 12X1.5	12,14
10	L	M14X1.5	WSVL 10 M 14X1.5	14,58	STA WSVL 10 M 14X1.5	12,56
12	L	M16X1.5	WSVL 12 M 16X1.5	18,13	STA WSVL 12 M 16X1.5	15,66
15	L	M18X1.5	WSVL 15 M 18X1.5	21,27	STA WSVL 15 M 18X1.5	18,13
18	L	M22X1.5	WSVL 18 M 22X1.5	29,38	STA WSVL 18 M 22X1.5	24,92
22	L	M26X1.5	WSVL 22 M 26X1.5	42,84	STA WSVL 22 M 26X1.5	36,50
28	L	M33X2	WSVL 28 M 33X2	70,94	STA WSVL 28 M 33X2	60,36
35	L	M42X2	WSVL 35 M 42X2	108,17	STA WSVL 35 M 42X2	92,68
42	L	M48X2	WSVL 42 M 48X2	144,47	STA WSVL 42 M 48X2	123,05
6	S	M12X1.5	WSVS 6 M 12X1.5	14,35	STA WSVS 6 M 12X1.5	12,44
8	S	M14X1.5	WSVS 8 M 14X1.5	14,86	STA WSVS 8 M 14X1.5	12,83
10	S	M16X1.5	WSVS 10 M 16X1.5	18,55	STA WSVS 10 M 16X1.5	16,03
12	S	M18X1.5	WSVS 12 M 18X1.5	20,68	STA WSVS 12 M 18X1.5	17,83
16	S	M22X1.5	WSVS 16 M 22X1.5	30,52	STA WSVS 16 M 22X1.5	25,87
20	S	M27X2	WSVS 20 M 27X2	47,03	STA WSVS 20 M 27X2	39,86
25	S	M33X2	WSVS 25 M 33X2	72,82	STA WSVS 25 M 33X2	60,86
30	S	M42X2	WSVS 30 M 42X2	112,46	STA WSVS 30 M 42X2	95,59
38	S	M48X2	WSVS 38 M 48X2	150,78	STA WSVS 38 M 48X2	127,79

Por razones logísticas y de producción, estos productos se suministrarán según disponibilidad (Zn/Ni; CrIII; CrVI). Las referencias más estándar (equivalentes a la serie B, ver págs. (174-181), se suministrarán habitualmente en Zn/Ni. / Pour des raisons logistiques et de fabrication, les produits (Zn/Ni; CrIII; CrVI) seront fournis selon disponibilité. Les références standard, équivalentes à la série B, voir pages (174-181), seront fournies normalement en Zn/Ni. / For logistics and manufacturing reasons, products (Zn/Ni; CrIII; CrVI) will be supplied upon availability. Standard references, equivalent to B series, see pages (174-181), will, usually, be supplied in Zn/Ni. / Per ragioni di logistica e di produzione, questi articoli saranno forniti secondo la disponibilità (Zn/Ni; CrIII; CrVI) I codici più standard (equivalenti alla serie B, vedere pagine (174-181), saranno forniti abitualmente in Zn/Ni.

# Racores DIN 2353

Raccords à bague DIN 2353  
DIN 2353 Pipe fittings  
Raccordi ad anello DIN 2353

## Tapón de cierre para tubo

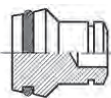

Bouchon de fermeture avec o'ring  
Blanking plug with o'ring  
Tappo di chiusura con o'ring

TUBO PIPE	SERIE	REFERENCIA PART N°	€
6	L/S	BUTZEN L 6	0,77
8	L/S	BUTZEN L 8	0,95
10	L/S	BUTZEN L 10	1,02
12	L/S	BUTZEN L 12	1,23
15	L	BUTZEN L 15	1,64
18	L	BUTZEN L 18	1,78
22	L	BUTZEN L 22	2,81
28	L	BUTZEN L 28	4,70
35	L	BUTZEN L 35	9,25
42	L	BUTZEN L 42	14,32
14	S	BUTZEN S 14	3,09
16	S	BUTZEN S 16	1,75
20	S	BUTZEN S 20	2,66
25	S	BUTZEN S 25	3,74
30	S	BUTZEN S 30	6,52
38	S	BUTZEN S 38	12,00

## Tapón de cierre Allen rosca Métrica con junta



Bouchon Allen Métrique avec o'ring  
Blanking plug with captive seal Metric cyl  
Tappo cilindrico Metrico esagono incassato con guarnizione

ROSCA THREAD	REFERENCIA PART N°	€
M10X1	STOPFEN M 10X1	1,48
M12X1.5	STOPFEN M 12X1.5	1,93
M14X1.5	STOPFEN M 14X1.5	2,11
M16X1.5	STOPFEN M 16X1.5	2,50
M18X1.5	STOPFEN M 18X1.5	2,48
M22X1.5	STOPFEN M 22X1.5	3,16
M26X1.5	STOPFEN M 26X1.5	4,68
M27X2	STOPFEN M 27X2	4,15
M33X2	STOPFEN M 33X2	5,49
M42X2	STOPFEN M 42X2	7,93
M48X2	STOPFEN M 48X2	10,89

## Tapón de cierre Allen rosca BSP con junta



Bouchon Allen gaz avec o'ring  
Blanking plug with captive seal BSP cyl  
Tappo cilindrico BSP esagono incassato con o'ring

ROSCA THREAD	REFERENCIA PART N°	€
1/8" BSP	STOPFEN 1/8	1,09
1/4" BSP	STOPFEN 1/4	1,21
3/8" BSP	STOPFEN 3/8	1,70
1/2" BSP	STOPFEN 1/2	2,02
3/4" BSP	STOPFEN 3/4	3,05
1" BSP	STOPFEN 1	5,86
1"1/4 BSP	STOPFEN 1 1/4	9,93
1"1/2 BSP	STOPFEN 1 1/2	11,60
2" BSP	STOPFEN 2	30,89

## Tapón

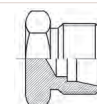

Bouchon  
Plug  
Tappo

TUBO PIPE	SERIE	ROSCA THREAD	REFERENCIA PART N°	€
6	L	12x1.5	STA TML 6	1,50
8	L	14x1.5	STA TML 8	1,75
10	L	16x1.5	STA TML 10	2,08
12	L	18x1.5	STA TML 12	2,45
15	L	22x1.5	STA TML 15	3,45
18	L	26x1.5	STA TML 18	5,20
22	L	30x2	STA TML 22	7,32
28	L	36x2	STA TML 28	13,72
35	L	45x2	STA TML 35	22,86
42	L	52x2	STA TML 42	31,86
6	S	14x1.5	STA TMS 6	1,78
8	S	16x1.5	STA TMS 8	2,13
10	S	18x1.5	STA TMS 10	2,51
12	S	20x1.5	STA TMS 12	2,95
14	S	22x1.5	STA TMS 14	5,36
16	S	24x1.5	STA TMS 16	5,53
20	S	30x2	STA TMS 20	8,31
25	S	36x2	STA TMS 25	14,51
30	S	42x2	STA TMS 30	22,11
38	S	52x2	STA TMS 38	32,26

Por razones logísticas y de producción, estos productos se suministrarán según disponibilidad (Zn/Ni; CrIII; CrVI). Las referencias más estándar (equivalentes a la serie B, ver págs. (174-181), se suministrarán habitualmente en Zn/Ni. / Pour des raisons logistiques et de fabrication, les produits (Zn/Ni; CrIII; CrVI) seront fournis selon disponibilité. Les références standard, équivalentes à la série B, voir pages (174-181), seront fournies normalement en Zn/Ni. / For logistics and manufacturing reasons, products (Zn/Ni; CrIII; CrVI) will be supplied upon availability. Standard references, equivalent to B series, see pages (174-181), will, usually, be supplied in Zn/Ni. / Per ragioni di logistica e di produzione, questi articoli saranno forniti secondo la disponibilità (Zn/Ni; CrIII; CrVI) I codici più standard (equivalenti alla serie B, vedere pagine (174-181), saranno forniti abitualmente in Zn/Ni.

## Racores DIN 2353

Raccords à bague DIN 2353  
DIN 2353 Pipe fittings  
Raccordi ad anello DIN 2353

Pipe

DIN 2353 Pipe Fittings

Gas tube fittings

JIC 37° fittings

SAE Flanges

Clamps

Machines for  
processing rigid pipes

### Antirretorno tubo-tubo

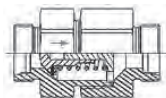

Clapet antiretour bidirectional tube-tube

Non-return valve tube-tube

Valvola di ritegno tubo-tubo

TUBO PIPE	SERIE	REFERENCIA PART N°	€
6	L	RHDL 6	15,09
8	L	RHDL 8	15,80
10	L	RHDL 10	19,34
12	L	RHDL 12	24,20
15	L	RHDL 15	31,66
18	L	RHDL 18	41,42
22	L	RHDL 22	66,63
28	L	RHDL 28	94,17
35	L	RHDL 35	121,66
42	L	RHDL 42	142,76
6	S	RHDS 6	20,31
8	S	RHDS 8	20,99
10	S	RHDS 10	25,07
12	S	RHDS 12	26,52
14	S	RHDS 14	44,76
16	S	RHDS 16	42,03
20	S	RHDS 20	68,76
25	S	RHDS 25	85,42
30	S	RHDS 30	107,27
38	S	RHDS 38	136,63

### Antirretorno tubo - rosca BSP

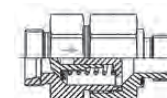

Clapet antiretour unidir. à droite tube-mâle BSP

Non-return valve flow towards male stud end BSP cyl

Valvola di ritegno a destra

TUBO PIPE	SERIE	ROSCA THREAD	REFERENCIA PART N°	€
6	L	1/8" BSP	RHZZ 6 R 1/8	14,49
8	L	1/4" BSP	RHZZ 8 R1/4	16,03
10	L	1/4" BSP	RHZZ 10 R1/4	20,34
12	L	3/8" BSP	RHZZ 12 R3/8	24,03
15	L	1/2" BSP	RHZZ 15 R1/2	30,14
18	L	1/2" BSP	RHZZ 18 R1/2	41,18
22	L	3/4" BSP	RHZZ 22 R 3/4	66,39
28	L	1" BSP	RHZZ 28 R1	95,68
35	L	1"1/4 BSP	RHZZ 35 R1 1/4	123,62
42	L	1"1/2 BSP	RHZZ 42 R1 1/2	137,28
6	S	1/4" BSP	RHZZ 6 R 1/4	20,49
8	S	1/4" BSP	RHZZ 8 R1/4	20,75
10	S	3/8" BSP	RHZZ 10 R 3/8	25,03
12	S	3/8" BSP	RHZZ 12 R3/8	24,01
14	S	1/2" BSP	RHZZ 14 R 1/2	46,53
16	S	1/2" BSP	RHZZ 16 R1/2	41,76
20	S	3/4" BSP	RHZZ 20 R3/4	67,14
25	S	1" BSP	RHZZ 25 R1	81,11
30	S	1"1/4 BSP	RHZZ 30 R1 1/4	106,96
38	S	1"1/2 BSP	RHZZ 38 R1 1/2	134,21

### Antirretorno rosca BSP - tubo

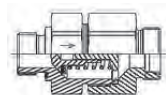

Clapet antiretour unidir. à gauche mâle BSP-tube

Non-return valve flow from male stud end BSP cyl

Valvola di ritegno a sinistra

TUBO PIPE	SERIE	ROSCA THREAD	REFERENCIA PART N°	€
6	L	1/8" BSP	RHVL 6 R1/8	14,63
8	L	1/4" BSP	RHVL 8 R 1/4	16,87
10	L	1/4" BSP	RHVL 10 R 1/4	20,42
12	L	3/8" BSP	RHVL 12 R3/8	24,11
15	L	1/2" BSP	RHVL 15 R 1/2	30,30
18	L	1/2" BSP	RHVL 18 R1/2	41,36
22	L	3/4" BSP	RHVL 22 R3/4	66,58
28	L	1" BSP	RHVL 28 R1	95,98
35	L	1"1/4 BSP	RHVL 35 R1 1/4	123,93
42	L	1"1/2 BSP	RHVL 42 R1 1/2	137,66
6	S	1/4" BSP	RHVS 6 R1/4	20,44
8	S	1/4" BSP	RHVS 8 R1/4	20,86
10	S	3/8" BSP	RHVS 10 R3/8	25,15
12	S	3/8" BSP	RHVS 12 R3/8	26,59
14	S	1/2" BSP	RHVS 14 R 1/2	44,97
16	S	1/2" BSP	RHVS 16 R1/2	41,93
20	S	3/4" BSP	RHVS 20 R3/4	67,32
25	S	1" BSP	RHVS 25 R1	81,34
30	S	1"1/4 BSP	RHVS 30 R1 1/4	107,25
38	S	1"1/2 BSP	RHVS 38 R 1 1/2	134,58

Por razones logísticas y de producción, estos productos se suministrarán según disponibilidad (Zn/Ni; CrIII; CrVI). Las referencias más estándar (equivalentes a la serie B, ver págs. (174-181), se suministrarán habitualmente en Zn/Ni. / Pour des raisons logistiques et de fabrication, les produits (Zn/Ni; CrIII; CrVI) seront fournis selon disponibilité. Les références standard, équivalentes à la série B, voir pages (174-181), seront fournies normalement en Zn/Ni. / For logistics and manufacturing reasons, products (Zn/Ni; CrIII; CrVI) will be supplied upon availability. Standard references, equivalent to B series, see pages (174-181), will, usually, be supplied in Zn/Ni. / Per ragioni di logistica e di produzione, questi articoli saranno forniti secondo la disponibilità (Zn/Ni; CrIII; CrVI) I codici più standard (equivalenti alla serie B, vedere pagine (174-181), saranno forniti abitualmente in Zn/Ni.

## Racores DIN 2353 sin tuerca y anillo CrIII

Raccords DIN 2353 sans écrou et bague CrIII

DIN 2353 pipe fittings without nut and ring CrIII

Raccordi DIN 2353 senza dado e anello CrIII

## Racores DIN 2353 sin tuerca y anillo CrIII

Raccords DIN 2353 sans écrou et bague CrIII  
 DIN 2353 Pipe fittings without nut and ring CrIII  
 Raccordi DIN 2353 senza dado e anello CrIII

Pipe

DIN 2353 Pipe Fittings

Gas tube fittings

JIC 37° fittings

SAE Flanges

Clamps

Machines for  
processing rigid pipes

### Tuerca Métrica DIN 3870



Écrou Métrique DIN 3870  
 Nuts DIN 3870  
 Dadi Metrici DIN 3870

TUBO PIPE	SERIE	ROSCA THREAD	REFERENCIA PART N°	€
6	L	M12X1,5	B ML 6	0,29
8	L	M14X1,5	B ML 8	0,33
10	L	M16X1,5	B ML 10	0,40
12	L	M18x1,5	B ML 12	0,50
15	L	M22X1,5	B ML 15	0,90
18	L	M26X1,5	B ML 18	1,31
22	L	M30X2	B ML 22	1,85
28	L	M36X2	B ML 28	2,74
35	L	M45X2	B ML 35	4,61
42	L	M52X2	B ML 42	6,73
6	S	M14X1,5	B MS 6	0,40
8	S	M16X1,5	B MS 8	0,44
10	S	M18X1,5	B MS 10	0,63
12	S	M20X1,5	B MS 12	0,70
14	S	M22X1,5	B MS 14	1,06
16	S	M24X1,5	B MS 16	1,32
20	S	M30X2	B MS 20	2,08
30	S	M42X2	B MS 30	5,27
25	S	M36x2	B MS 25	4,64
38	S	M52X2	B MS 38	8,27

### Anillos de corte DIN 3861



Bague Métrique DIN 3861  
 Cutting rings DIN 3861  
 Anelli DIN 3861

TUBO PIPE	SERIE	REFERENCIA PART N°	€
6	L/S	B ACL 6	0,26
8	L/S	B ACL 8	0,28
10	L/S	B ACL 10	0,36
12	L/S	B ACL 12	0,37
15	L	B ACL 15	0,45
18	L	B ACL 18	0,66
22	L	B ACL 22	0,74
28	L	B ACL 28	1,10
35	L	B ACL 35	1,63
42	L	B ACL 42	2,20
14	S	B ACS 14	0,65
16	S	B ACS 16	0,71
20	S	B ACS 20	0,86
25	S	B ACS 25	1,10
30	S	B ACS 30	1,34
38	S	B ACS 38	1,72

### Unión recta tubo-tubo

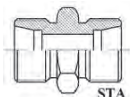

Union double  
 Straight coupling  
 Raccordo intermedio diritto

TUBO PIPE	SERIE	REFERENCIA PART N°	€
6	L	B STA DL 6	0,59
8	L	B STA DL 8	0,74
10	L	B STA DL 10	0,82
12	L	B STA DL 12	0,95
15	L	B STA DL 15	1,30
18	L	B STA DL 18	1,65
22	L	B STA DL 22	2,68
28	L	B STA DL 28	5,04
35	L	B STA DL 35	7,27
42	L	B STA DL 42	11,19
6	S	B STA DS 6	1,23
8	S	B STA DS 8	1,36
10	S	B STA DS 10	1,13
12	S	B STA DS 12	1,56
14	S	B STA DS 14	2,02
16	S	B STA DS 16	2,08
20	S	B STA DS 20	3,29
25	S	B STA DS 25	6,05
30	S	B STA DS 30	8,65
38	S	B STA DS 38	13,83

### Unión en codo tubo-tubo



Coude égal  
 Equal elbow coupling  
 Raccordo intermedio a 90°

TUBO PIPE	SERIE	REFERENCIA PART N°	€
6	L	B STA EL 6	2,60
8	L	B STA EL 8	2,67
10	L	B STA EL 10	2,68
12	L	B STA EL 12	2,86
15	L	B STA EL 15	4,22
18	L	B STA EL 18	5,45
22	L	B STA EL 22	7,10
28	L	B STA EL 28	12,13
35	L	B STA EL 35	21,62
42	L	B STA EL 42	27,67
6	S	B STA ES 6	3,55
8	S	B STA ES 8	4,19
10	S	B STA ES 10	4,45
12	S	B STA ES 12	3,64
14	S	B STA ES 14	4,93
16	S	B STA ES 16	5,37
20	S	B STA ES 20	7,88
25	S	B STA ES 25	12,39
30	S	B STA ES 30	23,55
38	S	B STA ES 38	37,76

## Racores DIN 2353 sin tuerca y anillo CrIII

Raccords DIN 2353 sans écrou et bague CrIII  
DIN 2353 Pipe fittings without nut and ring CrIII  
Raccordi DIN 2353 senza dado e anello CrIII

### Unión en T tubo tubo

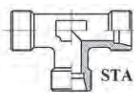

Té égal

Equal Tee

Raccordo intermedio a T

TUBO PIPE	SERIE	REFERENCIA PART N°	€
6	L	B STA TL 6	3,12
8	L	B STA TL 8	3,20
10	L	B STA TL 10	3,64
12	L	B STA TL 12	4,16
15	L	B STA TL 15	5,51
18	L	B STA TL 18	7,94
22	L	B STA TL 22	10,88
28	L	B STA TL 28	18,92
35	L	B STA TL 35	32,40
42	L	B STA TL 42	51,13
10	S	B STA TS 10	6,13
12	S	B STA TS 12	6,25
14	S	B STA TS 14	9,00
16	S	B STA TS 16	8,83
20	S	B STA TS 20	12,72
25	S	B STA TS 25	20,11
30	S	B STA TS 30	24,21
38	S	B STA TS 38	36,32
6	S	B STA TS 6	3,89
8	S	B STA TS 8	4,32

### Unión recta reducción tubo-tubo

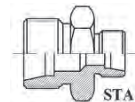

Union double en réduction

Straight reducing coupling

Raccordo intermedio di riduzione

TUBO PIPE	SERIE	REFERENCIA PART N°	€	
8	6	L	B STA DL 8-6	1,01
10	6	L	B STA DL 10-6	1,11
10	8	L	B STA DL 10-8	1,11
12	10	L	B STA DL 12-10	1,21
15	12	L	B STA DL 15-12	1,82
18	15	L	B STA DL 18-15	2,02
16	14	S	B STA DS 16-14	2,42
20	16	S	B STA DS 20-16	3,83
25	20	S	B STA DS 25-20	7,06

### Racor en codo rosca cónica BSPT



Union coude mâle gaz conique type G

Male stud elbow BSPT

Raccordo di estremità a 90° conico BSPT

TUBO PIPE	SERIE	ROSCA THREAD	REFERENCIA PART N°	€
6	L	1/8" BSPT	B STA CKL 6 R 1/8	2,25
6	L	1/4" BSPT	B STA CKL 6 R 1/4	2,42
8	L	1/8" BSPT	B STA CKL 8 R 1/8	3,20
8	L	1/4" BSPT	B STA CKL 8 R 1/4	3,20
10	L	1/4" BSPT	B STA CKL 10 R 1/4	3,03
10	L	3/8" BSPT	B STA CKL 10 R 3/8	3,03
12	L	1/4" BSPT	B STA CKL 12 R 1/4	3,03
12	L	3/8" BSPT	B STA CKL 12 R 3/8	2,80
15	L	3/8" BSPT	B STA CKL 15 R 3/8	5,10
15	L	1/2" BSPT	B STA CKL 15 R 1/2	5,34
18	L	1/2" BSPT	B STA CKL 18 R 1/2	7,81
22	L	3/4" BSPT	B STA CKL 22 R 3/4	14,00
12	S	3/8" BSPT	B STA CKS 12 R 3/8	5,19
14	S	1/2" BSPT	B STA CKS 14 R 1/2	7,98
16	S	1/2" BSPT	B STA CKS 16 R 1/2	6,15
20	S	3/4" BSPT	B STA CKS 20 R 3/4	18,22
25	S	1" BSPT	B STA CKS 25 R 1	26,72

## Racores DIN 2353 sin tuerca y anillo CrIII

Raccords DIN 2353 sans écrou et bague CrIII  
DIN 2353 Pipe fittings without nut and ring CrIII  
Raccordi DIN 2353 senza dado e anello CrIII

Pipe

DIN 2353 Pipe Fittings

Gas tube fittings

JIC 37° fittings

SAE Flanges

Clamps

Machines for processing rigid pipes

### Racor recto rosca cilíndrica BSP

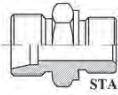

Union simple mâle gaz cyl  
Straight male stud coupling BSP cyl  
Raccordo di estremità diritto BSP

TUBO PIPE	SERIE	ROSCA THREAD	REFERENCIA PART N°	€
6	L	1/8" BSP	B STA AL 6 R 1/8	0,59
6	L	1/4" BSP	B STA AL 6 R 1/4	0,78
6	L	3/8" BSP	B STA AL 6 R 3/8	1,68
8	L	1/8" BSP	B STA AL 8 R 1/8	1,05
8	L	1/4" BSP	B STA AL 8 R 1/4	0,89
8	L	3/8" BSP	B STA AL 8 R 3/8	1,13
10	L	1/4" BSP	B STA AL 10 R 1/4	0,80
10	L	3/8" BSP	B STA AL 10 R 3/8	1,26
10	L	1/2" BSP	B STA AL 10 R 1/2	1,65
12	L	1/4" BSP	B STA AL 12 R 1/4	1,26
12	L	3/8" BSP	B STA AL 12 R 3/8	1,26
12	L	1/2" BSP	B STA AL 12 R 1/2	1,92
15	L	3/8" BSP	B STA AL 15 R 3/8	1,65
15	L	1/2" BSP	B STA AL 15 R 1/2	1,78
18	L	1/2" BSP	B STA AL 18 R 1/2	1,68
22	L	1/2" BSP	B STA AL 22 R 1/2	3,03
22	L	3/4" BSP	B STA AL 22 R 3/4	3,03
28	L	1" BSP	B STA AL 28 R 1	5,57
6	S	1/4" BSP	B STA AS 6 R 1/4	1,30
8	S	1/4" BSP	B STA AS 8 R 1/4	1,30
10	S	1/4" BSP	B STA AS 10 R 1/4	1,66
10	S	3/8" BSP	B STA AS 10 R 3/8	1,65
12	S	3/8" BSP	B STA AS 12 R 3/8	1,65
12	S	1/2" BSP	B STA AS 12 R 1/2	2,42
14	S	3/8" BSP	B STA AS 14 R 3/8	2,02
14	S	1/2" BSP	B STA AS 14 R 1/2	2,42
16	S	3/8" BSP	B STA AS 16 R 3/8	2,62
16	S	3/8" BSP	B STA AS 16 R 1/2	2,25
16	S	3/4" BSP	B STA AS 16 R 3/4	3,83
20	S	3/4" BSP	B STA AS 20 R 3/4	3,29
25	S	1" BSP	B STA AS 25 R 1	6,31
30	S	1" BSP	B STA AS 30 R 1	9,58
30	S	1 1/4" BSP	B STA AS 30 R 1 1/4	13,51
38	S	1 1/2" BSP	B STA AS 38 R 1 1/2	15,37

### Racor recto rosca cilíndrica BSP con junta

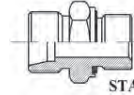

Union simple mâle gaz cyl avec o'ring  
Straight male stud coupling with captive seal BSP cyl  
Raccordo di estremità diritto BSP con guarnizione

TUBO PIPE	SERIE	ROSCA THREAD	REFERENCIA PART N°	€
6	L	1/8" BSP	B STA AL 6 R 1/8 WD	1,04
6	L	1/4" BSP	B STA AL 6 R 1/4 WD	1,30
8	L	1/8" BSP	B STA AL 8 R 1/8 WD	2,53
8	L	3/8" BSP	B STA AL 8 R 3/8 WD	1,61
10	L	1/4" BSP	B STA AL 10 R 1/4 WD	0,95
10	L	3/8" BSP	B STA AL 10 R 3/8 WD	1,39
10	L	1/2" BSP	B STA AL 10 R 1/2 WD	2,16
12	L	1/4" BSP	B STA AL 12 R 1/4 WD	1,65
12	L	3/8" BSP	B STA AL 12 R 3/8 WD	1,39
12	L	1/2" BSP	B STA AL 12 R 1/2 WD	2,08
15	L	3/8" BSP	B STA AL 15 R 3/8 WD	2,32
15	L	1/2" BSP	B STA AL 15 R 1/2 WD	1,99
18	L	1/2" BSP	B STA AL 18 R 1/2 WD	2,08
18	L	3/4" BSP	B STA AL 18 R 3/4 WD	2,51
22	L	3/4" BSP	B STA AL 22 R 3/4 WD	2,88
22	L	1" BSP	B STA AL 22 R 1 WD	6,15
28	L	1" BSP	B STA AL 28 R 1 WD	5,57
8	S	1/4" BSP	B STA AS 8 R 1/4 WD	1,21
10	S	1/4" BSP	B STA AS 10 R 1/4 WD	1,72
10	S	3/8" BSP	B STA AS 10 R 3/8 WD	2,24
12	S	1/4" BSP	B STA AS 12 R 1/4 WD	1,72
12	S	3/8" BSP	B STA AS 12 R 3/8 WD	1,72
12	S	1/2" BSP	B STA AS 12 R 1/2 WD	2,25
14	S	1/2" BSP	B STA AS 14 R 1/2 WD	2,62
16	S	3/8" BSP	B STA AS 16 R 3/8 WD	8,35
16	S	1/2" BSP	B STA AS 16 R 1/2 WD	2,25
20	S	3/4" BSP	B STA AS 20 R 3/4 WD	3,46
25	S	1" BSP	B STA AS 25 R 1 WD	6,31

### Racor recto rosca cilíndrica BSP 60°



Union simple mâle gaz cyl 60°  
Straight male stud coupling BSP cyl 60°  
Raccordo di estremità diritto BSP 60°

TUBO PIPE	SERIE	ROSCA THREAD	REFERENCIA PART N°	€
6	L	1/8 BSP	B STA AL 6 RC 1/8	0,98
6	L	1/4 BSP	B STA AL 6 RC 1/4	1,37
8	L	1/4" BSP	B STA AL 8 RC 1/4	1,37
8	L	3/8" BSP	B STA AL 8 RC 3/8	1,30
10	L	1/4" BSP	B STA AL 10 RC 1/4	1,37
10	L	3/8" BSP	B STA AL 10 RC 3/8	1,69
10	L	1/2" BSP	B STA AL 10 RC 1/2	2,28
12	L	1/4" BSP	B STA AL 12 RC 1/4	1,43
12	L	3/8" BSP	B STA AL 12 RC 3/8	1,69
12	L	1/2" BSP	B STA AL 12 RC 1/2	2,28
15	L	3/8" BSP	B STA AL 15 RC 3/8	1,95
15	L	1/2" BSP	B STA AL 15 RC 1/2	2,41
18	L	1/2" BSP	B STA AL 18 RC 1/2	2,35
22	L	3/4" BSP	B STA AL 22 RC 3/4	3,26
28	L	1" BSP	B STA AL 28 RC 1	5,08
16	S	3/8" BSP	B STA AS 16 RC 3/8	2,74
10	S	1/2" BSP	B STA AS 16 RC 1/2	2,61
20	S	3/4" BSP	B STA AS 20 RC 3/4	4,04
25	S	1" BSP	B STA AS 25 RC 1	6,64

### Racor recto rosca cónica BSPT

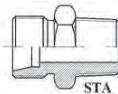

Union simple mâle conique  
Straight male stud coupling BSPT tapered  
Raccordo di estremità diritto BSPT cónico

TUBO PIPE	SERIE	ROSCA THREAD	REFERENCIA PART N°	€
6	L	1/4" BSPT	B STA AKL 6 R 1/4	1,04
8	L	1/4" BSPT	B STA AKL 8 R 1/4	1,04
10	L	1/4" BSPT	B STA AKL 10 R 1/4	1,12
10	L	3/8" BSPT	B STA AKL 10 R 3/8	1,40
12	L	1/4" BSPT	B STA AKL 12 R 1/4	1,30
12	L	3/8" BSPT	B STA AKL 12 R 3/8	1,30
12	L	1/2" BSPT	B STA AKL 12 R 1/2	1,73
10	S	3/8" BSPT	B STA AKS 10 R 3/8	1,21
12	S	3/8" BSPT	B STA AKS 12 R 3/8	1,72
16	S	1/2" BSPT	B STA AKS 16 R 1/2	2,62



## Racores DIN 2353 sin tuerca y anillo CrIII

Raccords DIN 2353 sans écrou et bague CrIII  
DIN 2353 Pipe fittings without nut and ring CrIII  
Raccordi DIN 2353 senza dado e anello CrIII

### Racor recto hembra rosca BSP

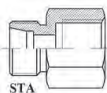

Union simple femelle gaz  
Female stud coupling BSP cyl  
Raccordo diritto femmina BSP

TUBO PIPE	SERIE	ROSCA THREAD	REFERENCIA PART N°	€
6	L	1/8" BSP	B STA GAIL 6 R 1/8	1,21
8	L	1/4" BSP	B STA GAIL 8 R 1/4	1,30
10	L	1/4" BSP	B STA GAIL 10 R 1/4	1,51
12	L	3/8" BSP	B STA GAIL 12 R 3/8	1,86
12	L	1/2" BSP	B STA GAIL 12 R 1/2	2,62
15	L	1/2" BSP	B STA GAIL 15 R 1/2	2,25
18	L	1/2" BSP	B STA GAIL 18 R 1/2	2,62
22	L	3/4" BSP	B STA GAIL 22 R 3/4	3,73
14	S	1/2" BSP	B STA GAIS 14 R 1/2	3,03
16	S	1/2" BSP	B STA GAIS 16 R 1/2	3,03
20	S	3/4" BSP	B STA GAIS 20 R 3/4	5,04
25	S	1" BSP	B STA GAIS 25 R 1	7,06

### Racor de reducción TL Métrica

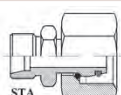

Union simple femelle tournante Métrique  
Standpipe reducers with taper  
Raccordo di riduzione cono 24 (serie leggera)

TUBO PIPE	SERIE	REFERENCIA PART N°	€
8	10	L B STA KORL 10-8 TLM	2,53
10	12	L B STA KORL 12-10 TLM	2,80
12	15	L B STA KORL 15-12 TLM	3,27
12	18	L B STA KORL 18-12 TLM	5,59
18	22	L B STA KORL 22-18 TLM	7,06
22	28	L B STA KORL 28-22 TLM	8,07
22	35	L B STA KORL 35-22 TLM	13,99
35	42	L B STA KORL 42-35 TLM	20,52
12	14	S B STA KORS 14-12 TLM	4,54
12	16	S B STA KORS 16-12 TLM	5,25
16	20	S B STA KORS 20-16 TLM	7,00
16	25	S B STA KORS 25-16 TLM	9,08
20	25	S B STA KORS 25-20 TLM	9,08

### Tubo roscado recto BSP TLM

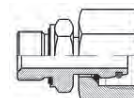

Adapteur tube lisse x mâle gaz a/ecrou+o'ring  
Straight stud standpipe adpt. w/captive seal&o'ring BSP cyl  
Adattatore diritto BSP TLM

TUBO PIPE	SERIE	ROSCA THREAD	REFERENCIA PART N°	€
6	L	1/8" BSP	B RAL 6 TLM R 1/8	2,22
8	L	1/4" BSP	B RAL 8 TLM R 1/4	3,03
10	L	1/4" BSP	B RAL 10 TLM R 1/4	3,33
12	L	3/8" BSP	B RAL 12 TLM R 3/8	3,83
15	L	1/2" BSP	B RAL 15 TLM R 1/2	4,75
18	L	1/2" BSP	B RAL 18 TLM R 1/2	5,04
22	L	3/4" BSP	B RAL 22 TLM R 3/4	6,05
28	L	1" BSP	B RAL 28 TLM R 1	11,10
35	L	1" 1/4 BSP	B RAL 35 TLM R 1 1/4	21,18
42	L	1" 1/2 BSP	B RAL 42 TLM R 1 1/2	30,26
6	S	1/4" BSP	B RAS 6 TLM R 1/4	2,83
8	S	1/4" BSP	B RAS 8 TLM R 1/4	3,03
10	S	3/8" BSP	B RAS 10 TLM R 3/8	3,64
12	S	3/8" BSP	B RAS 12 TLM R 3/8	4,04
14	S	1/2" BSP	B RAS 14 TLM R 1/2	4,75
16	S	1/2" BSP	B RAS 16 TLM R 1/2	5,25
20	S	3/4" BSP	B RAS 20 TLM R 3/4	7,87
25	S	1" BSP	B RAS 25 TLM R 1	14,13
30	S	1" 1/4 BSP	B RAS 30 TLM R 1 1/4	23,21
38	S	1" 1/2 BSP	B RAS 38 TLM R 1 1/2	34,30

## Racores DIN 2353 sin tuerca y anillo CrIII

Raccords DIN 2353 sans écrou et bague CrIII  
DIN 2353 Pipe fittings without nut and ring CrIII  
Raccordi DIN 2353 senza dado e anello CrIII

Pipe

DIN 2353 Pipe Fittings

Gas tube fittings

JIC 37° fittings

SAE Flanges

Clamps

Machines for processing rigid pipes

### Racor en codo regulable con tuerca y anillo



Coude orientable tube lisse équipé  
Adjustable stud elbow with nut and ring  
Raccordo orientabile a 90° con dado e anello

TUBO PIPE	SERIE	REFERENCIA PART N°	€
6	L	B STA EEL 6 CTA	3,78
8	L	B STA EEL 8 CTA	4,60
10	L	B STA EEL 10 CTA	4,76
12	L	B STA EEL 12 CTA	4,76
15	L	B STA EEL 15 CTA	7,60
18	L	B STA EEL 18 CTA	8,05
22	L	B STA EEL 22 CTA	14,68
28	L	B STA EEL 28 CTA	18,00
35	L	B STA EEL 35 CTA	36,14
42	L	B STA EEL 42 CTA	53,83
6	S	B STA EES 6 CTA	4,84
8	S	B STA EES 8 CTA	5,36
10	S	B STA EES 10 CTA	5,87
12	S	B STA EES 12 CTA	7,09
14	S	B STA EES 14 CTA	10,62
16	S	B STA EES 16 CTA	10,30
20	S	B STA EES 20 CTA	12,77
25	S	B STA EES 25 CTA	20,84
30	S	B STA EES 30 CTA	32,06

### Racor en T tubo TL Métrica

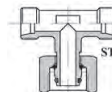

Té Orientable Métrique + o'ring  
Adjustable stud branch TEE with o'ring  
Raccordo orientabile a T con o'ring centrale

TUBO PIPE	SERIE	REFERENCIA PART N°	€
6	L	B STA TEL 6 TLM	5,04
8	L	B STA TEL 8 TLM	5,55
10	L	B STA TEL 10 TLM	5,37
12	L	B STA TEL 12 TLM	6,06
15	L	B STA TEL 15 TLM	9,08
18	L	B STA TEL 18 TLM	12,10
22	L	B STA TEL 22 TLM	14,13
28	L	B STA TEL 28 TLM	26,23
35	L	B STA TEL 35 TLM	32,29
42	L	B STA TEL 42 TLM	50,44
6	S	B STA TES 6 TLM	5,55
8	S	B STA TES 8 TLM	10,94
10	S	B STA TES 10 TLM	8,07
12	S	B STA TES 12 TLM	9,33
14	S	B STA TES 14 TLM	11,10
16	S	B STA TES 16 TLM	12,13
20	S	B STA TES 20 TLM	15,13
25	S	B STA TES 25 TLM	28,25
30	S	B STA TES 30 TLM	36,32
38	S	B STA TES 38 TLM	60,53

### Racor en codo tubo TL Métrica



Coude orientable Métrique + o'ring  
Adjustable stud elbow with o'ring  
Raccordo orientabile a 90° con o'ring

TUBO PIPE	SERIE	REFERENCIA PART N°	€
6	L	B STA EEL 6 TLM	3,78
8	L	B STA EEL 8 TLM	4,60
10	L	B STA EEL 10 TLM	4,76
12	L	B STA EEL 12 TLM	4,76
15	L	B STA EEL 15 TLM	7,60
18	L	B STA EEL 18 TLM	8,05
22	L	B STA EEL 22 TLM	14,68
28	L	B STA EEL 28 TLM	18,00
35	L	B STA EEL 35 TLM	36,14
42	L	B STA EEL 42 TLM	53,83
6	S	B STA EES 6 TLM	4,84
8	S	B STA EES 8 TLM	5,36
10	S	B STA EES 10 TLM	5,87
12	S	B STA EES 12 TLM	6,65
14	S	B STA EES 14 TLM	8,90
16	S	B STA EES 16 TLM	9,61
20	S	B STA EES 20 TLM	12,77
25	S	B STA EES 25 TLM	20,84
30	S	B STA EES 30 TLM	32,06

### Racor en L tubo TL Métrica

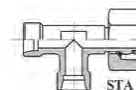

L Orientable renversé Métrique + o'ring  
Adjustable stud barrel L with o'ring  
Raccordo orientabile a T con o'ring laterale

TUBO PIPE	SERIE	ROSCA THREAD	REFERENCIA PART N°	€
6	L	M 12X1.5	B STA LEL 6 TLM	5,04
8	L	M14X1.5	B STA LEL 8 TLM	5,55
10	L	M16X1.5	B STA LEL 10 TLM	5,37
12	L	M 18X1.5	B STA LEL 12 TLM	6,06
15	L	M22X1.5	B STA LEL 15 TLM	9,08
18	L	M26X1.5	B STA LEL 18 TLM	10,04
22	L	M30X2	B STA LEL 22 TLM	14,13
28	L	M36X2	B STA LEL 28 TLM	26,23
35	L	M45X2	B STA LEL 35 TLM	32,29
42	L	M52X2	B STA LEL 42 TLM	50,44
6	S	M14X1.5	B STA LES 6 TLM	5,55
8	S	M16X1.5	B STA LES 8 TLM	6,05
10	S	M18X1.5	B STA LES 10 TLM	8,07
12	S	M20X1.5	B STA LES 12 TLM	10,09
14	S	M22X1.5	B STA LES 14 TLM	11,10
16	S	M24X1.5	B STA LES 16 TLM	13,12
20	S	M30X2	B STA LES 20 TLM	15,13
25	S	M36X2	B STA LES 25 TLM	28,25
30	S	42X2	B STA LES 30 TLM	36,32
38	S	M52X2	B STA LES 38 TLM	60,53

## Racores DIN 2353 sin tuerca y anillo CrIII

Raccords DIN 2353 sans écrou et bague CrIII  
DIN 2353 Pipe fittings without nut and ring CrIII  
Raccordi DIN 2353 senza dado e anello CrIII

### Racor recto para soldar

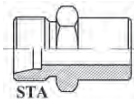

Mamelon hexagonal à souder Métrique (DIN 2353) équipé avec bague et écrou

Weldable straight coupling  
Raccordo diritto a saldare

TUBO PIPE	SERIE	REFERENCIA PART N°	€
6	L	B STA ASL 6	3,56
8	L	B STA ASL 8	2,92
10	L	B STA ASL 10	1,21
12	L	B STA ASL 12	1,31
15	L	B STA ASL 15	1,51
18	L	B STA ASL 18	2,02
22	L	B STA ASL 22	3,23
28	L	B STA ASL 28	5,34
35	L	B STA ASL 35	8,07
42	L	B STA ASL 42	12,10
14	S	B STA ASS 14	4,55
16	S	B STA ASS 16	2,42
20	S	B STA ASS 20	3,53
25	S	B STA ASS 25	6,56
30	S	B STA ASS 30	9,08
38	S	B STA ASS 38	20,44

### Boquilla para soldar

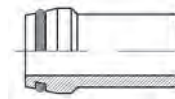

Collet cône Métrique (DIN 2353) à souder (BW) o'ring

Welding nipple  
Ogiva a saldare

TUBO PIPE	SERIE	REFERENCIA PART N°	€
8	S	B ORIS 8X1.5	1,21
10	S	B ORIS 10X2	1,31
12	S	B ORIS 12X2.5	1,51
16	S	B ORIS 16X3	1,82
20	S	B ORIS 20X4	2,72
25	S	B ORIS 25X4	3,73
30	S	B ORIS 30X5	5,25
38	S	B ORIS 38X5	8,58

### Racor recto pasatabiques con tuerca

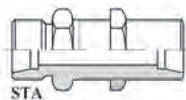

Union double passe cloison  
Straight bulkhead coupling  
Raccordo passaparete

TUBO PIPE	SERIE	REFERENCIA PART N°	€
6	L	B STA SVL 6	1,86
8	L	B STA SVL 8	2,17
10	L	B STA SVL 10	2,60
12	L	B STA SVL 12	3,20
15	L	B STA SVL 15	4,34
18	L	B STA SVL 18	6,26
22	L	B STA SVL 22	8,58
28	L	B STA SVL 28	11,60
35	L	B STA SVL 35	19,17
42	L	B STA SVL 42	28,25
6	S	B STA SVS 6	2,62
8	S	B STA SVS 8	2,83
10	S	B STA SVS 10	3,37
12	S	B STA SVS 12	4,54
14	S	B STA SVS 14	6,05
16	S	B STA SVS 16	6,86
20	S	B STA SVS 20	10,72
25	S	B STA SVS 25	17,15
30	S	B STA SVS 30	21,18
38	S	B STA SVS 38	51,46

### Racor en codo pasatabiques con tuerca

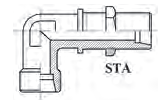

Coude égal passe cloison  
Elbow bulkhead coupling  
Raccordo passaparete a 90°

TUBO PIPE	SERIE	REFERENCIA PART N°	€
8	L	B STA USVL 8	4,84
10	L	B STA USVL 10	5,55
12	L	B STA USVL 12	6,53
15	L	B STA USVL 15	7,57
18	L	B STA USVL 18	9,08
22	L	B STA USVL 22	12,10
14	S	B STA USVS 14	7,06
16	S	B STA USVS 16	9,58
20	S	B STA USVS 20	13,12

## Racores DIN 2353 sin tuerca y anillo CrIII

Raccords DIN 2353 sans écrou et bague CrIII  
DIN 2353 Pipe fittings without nut and ring CrIII  
Raccordi DIN 2353 senza dado e anello CrIII

### Racor en codo orientable sin estrangulador rosca BSP

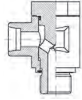

Equerre orientable sans étrangleur gaz BSP (passage total)  
Banjo coupling with captive seal and o-ring BSP cyl  
Raccordo orientabile a 90° ad occhio BSP con guarnizione

TUBO PIPE	SERIE	ROSCA THREAD	REFERENCIA PART N°	€
6	L	1/8" BSP	B STA WSVL 6 R 1/8	4,54
8	L	1/4" BSP	B STA WSVL 8 R 1/4	6,05
10	L	1/4" BSP	B STA WSVL 10 R 1/4	7,12
12	L	3/8" BSP	B STA WSVL 12 R 3/8	9,19
15	L	1/2" BSP	B STA WSVL 15 R 1/2	11,10
18	L	1/2" BSP	B STA WSVL 18 R 1/2	14,13
22	L	3/4" BSP	B STA WSVL 22 R 3/4	19,17
10	S	3/8" BSP	B STA WSVS 10 R 3/8	11,10
12	S	3/8" BSP	B STA WSVS 12 R 3/8	12,11
14	S	1/2" BSP	B STA WSVS 14 R 1/2	15,13
16	S	1/2" BSP	B STA WSVS 16 R 1/2	16,79
20	S	3/4" BSP	B STA WSVS 20 R 3/4	27,24
25	S	1" BSP	B STA WSVS 25 R 1	38,34

### Racor para manómetro BSP



Union pour manomètre gaz  
Gauge coupling BSP cyl  
Raccordo per manometri BSP

TUBO PIPE	SERIE	ROSCA THREAD	REFERENCIA PART N°	€
6	L	1/4" BSP	B STA MAVL 6 R 1/4	1,51
8	L	1/4" BSP	B STA MAVL 8 R 1/4	1,51

### Racor en codo orientable BSP-Métrico

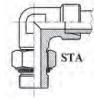

Coude réglable mâle BSP - Métrique  
90° Adjustable male stud elbow BSP - Metric  
Raccordo a 90° orientabile maschio BSP-Metrico

TUBO PIPE	SERIE	ROSCA THREAD	REFERENCIA PART N°	€
6	L	1/8" BSP	STA WEE 6L R 1/8	15,42
8	L	1/4" BSP	STA WEE 8L R 1/4	16,05
10	L	1/4" BSP	STA WEE 10L R 1/4	16,29
12	L	3/8" BSP	STA WEE 12L R 3/8	15,74
15	L	1/2" BSP	STA WEE 15L R 1/2	20,56
18	L	1/2" BSP	STA WEE 18L R 1/2	25,22
22	L	3/4" BSP	STA WEE 22L R 3/4	29,97
16	S	1/2" BSP	STA WEE 16S R 1/2	23,65
20	S	3/4" BSP	STA WEE 20S R 3/4	28,16
25	S	1" BSP	STA WEE 25S R 1	52,10

### Tapón de cierre para tubo



Bouchon de fermeture avec o'ring  
Blanking plug with o'ring  
Tappo di chiusura con o'ring

TUBO PIPE	SERIE	REFERENCIA PART N°	€
6	L/S	B BUTZEN L 6	0,52
8	L/S	B BUTZEN L 8	0,61
10	L/S	B BUTZEN L 10	0,70
12	L/S	B BUTZEN L 12	0,86
18	L	B BUTZEN L 18	1,13
22	L	B BUTZEN L 22	1,82
28	L	B BUTZEN L 28	2,53
35	L	B BUTZEN L 35	4,64
42	L	B BUTZEN L 42	7,57
14	S	B BUTZEN S 14	3,09
16	S	B BUTZEN S 16	1,21
20	S	B BUTZEN S 20	1,51
25	S	B BUTZEN S 25	2,32
30	S	B BUTZEN S 30	3,53
38	S	B BUTZEN S 38	5,95

### Tapón de cierre Allen rosca BSP con junta



Bouchon Allen gaz avec o'ring  
Blanking plug with captive seal BSP cyl  
Tappo cilindrico BSP esagono incassato con o'ring

ROSCA THREAD	REFERENCIA PART N°	€
1/8" BSP	B STOPFEN 1/8	0,74
1/4" BSP	B STOPFEN 1/4	0,86
3/8" BSP	B STOPFEN 3/8	1,11
1/2" BSP	B STOPFEN 1/2	1,30
3/4" BSP	B STOPFEN 3/4	1,82
1" BSP	B STOPFEN 1	3,03
1"1/4 BSP	B STOPFEN 1 1/4	5,04
1"1/2 BSP	B STOPFEN 1 1/2	7,06
2" BSP	B STOPFEN 2	18,16

## Racores DIN 2353 sin tuerca y anillo CrIII

Raccords DIN 2353 sans écrou et bague CrIII  
DIN 2353 Pipe fittings without nut and ring CrIII  
Raccordi DIN 2353 senza dado e anello CrIII

### Tapón de cierre Allen rosca Métrica con junta



Bouchon Allen Métrique avec o'ring

Blanking plug with captive seal Metric cyl

Tappo cilindrico Metrico esagono incassato con guarnizione

ROSCA THREAD	REFERENCIA PART N°	€
M10X1	<b>B STOPFEN M 10X1</b>	<b>0,91</b>
M12X1.5	<b>B STOPFEN M 12X1.5</b>	<b>1,01</b>
M14X1.5	<b>B STOPFEN M 14X1.5</b>	<b>1,11</b>
M16X1.5	<b>B STOPFEN M 16X1.5</b>	<b>1,21</b>
M18X1.5	<b>B STOPFEN M 18X1.5</b>	<b>1,31</b>
M22X1.5	<b>B STOPFEN M 22X1.5</b>	<b>1,41</b>
M26X1.5	<b>B STOPFEN M 26X1.5</b>	<b>1,82</b>
M27X2	<b>B STOPFEN M 27X2</b>	<b>1,82</b>
M33X2	<b>B STOPFEN M 33X2</b>	<b>3,03</b>
M42X2	<b>B STOPFEN M 42X2</b>	<b>6,05</b>

### Tapon

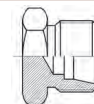

Bouchon

Plug

Tappo

TUBO PIPE	SERIE	ROSCA THREAD	REFERENCIA PART N°	€
6	L	M12x1.5	<b>B STA TML 6</b>	<b>0,71</b>
8	L	M14x1.5	<b>B STA TML 8</b>	<b>0,81</b>
10	L	M16x1.5	<b>B STA TML 10</b>	<b>1,01</b>
12	L	M18x1.5	<b>B STA TML 12</b>	<b>1,11</b>
15	L	M22x1.5	<b>B STA TML 15</b>	<b>1,21</b>
18	L	M26x1.5	<b>B STA TML 18</b>	<b>1,51</b>
22	L	M30x2	<b>B STA TML 22</b>	<b>2,02</b>
28	L	M36x2	<b>B STA TML 28</b>	<b>3,33</b>
35	L	M45x2	<b>B STA TML 35</b>	<b>6,05</b>
6	S	M14x1.5	<b>B STA TMS 6</b>	<b>0,91</b>
8	S	M16x1.5	<b>B STA TMS 8</b>	<b>2,13</b>
10	S	M18x1.5	<b>B STA TMS 10</b>	<b>1,01</b>
12	S	M20x1.5	<b>B STA TMS 12</b>	<b>1,21</b>
14	S	M22x1.5	<b>B STA TMS 14</b>	<b>1,51</b>
16	S	M24x1.5	<b>B STA TMS 16</b>	<b>1,82</b>
20	S	M30x2	<b>B STA TMS 20</b>	<b>2,72</b>
25	S	M36x2	<b>B STA TMS 25</b>	<b>4,64</b>
30	S	M42x2	<b>B STA TMS 30</b>	<b>7,57</b>
38	S	M52x2	<b>B STA TMS 38</b>	<b>12,10</b>

# Racores para tubo gas

Raccords tube gaz

Gas tube fittings

Raccordi per tubo gas

# 3

Racores para tubo gas

Raccords tube gaz | Gas tube fittings | Raccordi per tubo gas

184

## Racores para tubo gas

Raccords tube gaz | Gas tube fittings | Raccordi per tubo gas

Pipe

DIN 2353 Pipe Fittings

Gas tube fittings

JIC 37° fittings

SAE Flanges

Clamps

Machines for processing rigid pipes

### ▶ Tuercas y anillos | Écrous et bagues | Nuts and cutting rings | Dadi e anelli

185

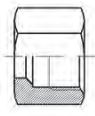

ML/MS

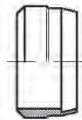

ACL

### ▶ Uniones tubo-tubo | Unions doubles | Straight couplings | Raccordi intermedi

185

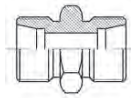

STA DL



STA TL

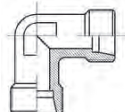

STA EL

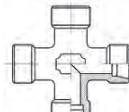

STA KVL

### ▶ Uniones tubo-rosca | Unions simples mâle | Male stud couplings | Raccordi di estremità

186

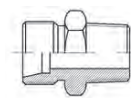

STA AKL R

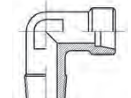

STA CKL R

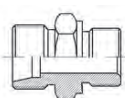

STA AL R

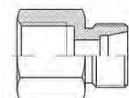

STA GAIL R



## Racores para tubo gas

Raccords tube gaz

Gas tube fittings

Raccordi per tubo gas

### Tuercas gas



Écrou gaz

Nut gas

Dado gas

TUBO PIPE	ROSCA THREAD	REFERENCIA PART N°	€
1/4" - 13.2	20X1,5	<b>ML 13.2</b>	<b>5,57</b>
3/8" - 16.7	24X1,5	<b>ML 16.7</b>	<b>7,66</b>
1/2" - 21.3	30X1,5	<b>ML 21.3</b>	<b>11,22</b>
3/4" - 26.7	36X1,5	<b>ML 26.7</b>	<b>21,69</b>
1" - 33.5	45X1,5	<b>ML 33.5</b>	<b>30,11</b>
1" 1/4 - 42.4	52X1,5	<b>ML 42.4</b>	<b>65,03</b>

### Anillo tubo gas



Bague tube gaz

Cutting ring gas

Anello tubo-gas

TUBO PIPE	REFERENCIA PART N°	€
1/4" - 13.2	<b>ACL 13.2</b>	<b>1,65</b>
3/8" - 16.7	<b>ACL 16.7</b>	<b>2,41</b>
1/2" - 21.3	<b>ACL 21.3</b>	<b>3,34</b>
3/4" - 26.7	<b>ACL 26.7</b>	<b>5,66</b>
1" - 33.5	<b>ACL 33.5</b>	<b>8,91</b>
1" 1/4 - 42.4	<b>ACL 42.4</b>	<b>13,94</b>

### Unión recta tubo-tubo

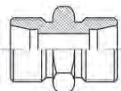

Union double

Straight coupling

Raccordo tubo-tubo

TUBO PIPE	SERIE	REFERENCIA PART N°	€
13.2	L	<b>STA DL 13.2</b>	<b>8,64</b>
16.7	L	<b>STA DL 16.7</b>	<b>10,24</b>
21.3	L	<b>STA DL 21.3</b>	<b>19,37</b>
26.7	L	<b>STA DL 26.7</b>	<b>24,32</b>
33.5	L	<b>STA DL 33.5</b>	<b>48,73</b>
42.4	L	<b>STA DL 42.4</b>	<b>83,42</b>

### Unión en codo tubo-tubo



Coude égal

Equal elbow coupling

Raccordo a 90° tubo-tubo

TUBO PIPE	SERIE	REFERENCIA PART N°	€
13.2	L	<b>STA EL 13.2</b>	<b>16,79</b>
16.7	L	<b>STA EL 16.7</b>	<b>19,06</b>
21.3	L	<b>STA EL 21.3</b>	<b>31,27</b>
26.7	L	<b>STA EL 26.7</b>	<b>50,51</b>
33.5	L	<b>STA EL 33.5</b>	<b>107,16</b>
42.4	L	<b>STA EL 42.4</b>	<b>187,24</b>

### Unión en T tubo-tubo

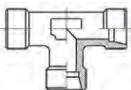

Té égal

Equal TEE

Raccordo a T tubo-tubo

TUBO PIPE	SERIE	REFERENCIA PART N°	€
13.2	L	<b>STA TL 13.2</b>	<b>20,62</b>
16.7	L	<b>STA TL 16.7</b>	<b>24,05</b>
21.3	L	<b>STA TL 21.3</b>	<b>38,93</b>
26.7	L	<b>STA TL 26.7</b>	<b>60,48</b>
33.5	L	<b>STA TL 33.5</b>	<b>135,97</b>

### Unión en cruz tubo-tubo



Croix égale

Equal cross

Raccordo a croce tubo-tubo

TUBO PIPE	SERIE	REFERENCIA PART N°	€
16.7	L	<b>STA KVL 16.7</b>	<b>78,97</b>

## Racores para tubo gas

Raccords tube gaz

Gas tube fittings

Raccordi per tubo gas

Pipe

DIN 2353 Pipe Fittings

Gas tube fittings

JIC 37° fittings

SAE Flanges

Clamps

Machines for processing rigid pipes

### Unión recta tubo-rosca cónica BSPT

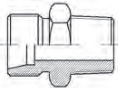

Union mâle gaz conique

Straight male stud coupling tapered

Raccordo diritto conico per tubo gas

TUBO PIPE	S.	ROSCA THREAD	REFERENCIA PART N°	€
13.2	L	1/2" BSPT	STA AKL 13.2 R 1/2	9,26
16.7	L	1/4" BSPT	STA AKL 16.7 R 1/4	15,72
16.7	L	3/8" BSPT	STA AKL 16.7 R 3/8	10,11
16.7	L	1/2" BSPT	STA AKL 16.7 R 1/2	11,27
21.3	L	1/2" BSPT	STA AKL 21.3 R 1/2	15,14
21.3	L	3/4" BSPT	STA AKL 21.3 R 3/4	15,14
26.7	L	3/4" BSPT	STA AKL 26.7 R 3/4	25,97
26.7	L	1" BSPT	STA AKL 26.7 R 1	50,19
33.5	L	1" BSPT	STA AKL 33.5 R 1	68,86
42.4	L	1 1/4" BSPT	STA AKL 42.4 R 1 1/4	107,43

### Unión en codo tubo-rosca cónica BSPT



Coude mâle gaz conique

Male stud elbow BSPT

Raccordo a 90° conico per tubo gas

TUBO PIPE	S.	ROSCA THREAD	REFERENCIA PART N°	€
13.2	L	1/4" BSPT	STA CKL 13.2 R 1/4	15,81
13.2	L	3/8" BSPT	STA CKL 13.2 R 3/8	15,81
16.7	L	3/8" BSPT	STA CKL 16.7 R 3/8	19,29
21.3	L	1/2" BSPT	STA CKL 21.3 R 1/2	37,01
26.7	L	3/4" BSPT	STA CKL 26.7 R 3/4	56,65
33.5	L	1" BSPT	STA CKL 33.5 R 1	146,17
42.4	L	1 1/4" BSPT	STA CKL 42.4 R 1 1/4	293,77

### Unión recta tubo-rosca cilíndrica BSP

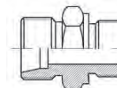

Union mâle gaz cyl

Straight male stud coupling cyl

Raccordo diritto cilindrico per tubo gas

TUBO PIPE	SERIE	ROSCA THREAD	REFERENCIA PART N°	€
13.2	L	1/4" BSP	STA AL 13.2 R 1/4	7,88
13.2	L	3/8" BSP	STA AL 13.2 R 3/8	7,88
16.7	L	3/8" BSP	STA AL 16.7 R 3/8	9,80
16.7	L	1/2" BSP	STA AL 16.7 R 1/2	11,67
21.3	L	1/2" BSP	STA AL 21.3 R 1/2	15,19
26.7	L	3/4" BSP	STA AL 26.7 R 3/4	21,11
42.4	L	1 1/4" BSP	STA AL 42.4 R 1 1/4	92,64
42.4	L	1 1/2" BSP	STA AL 42.4 R 1 1/2	116,07

### Unión recta tubo-hembra fija BSP

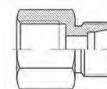

Union femelle gaz cyl

Female stud coupling gas

Raccordo diritto femmina per tubo gas

TUBO PIPE	SERIE	ROSCA THREAD	REFERENCIA PART N°	€
13.2	L	3/8" BSP	STA GAIL 13.2 R 3/8	16,21
13.2	L	1/2" BSP	STA GAIL 13.2 R 1/2	15,10

## Atención | Attention | Warning | Attenzione

- Una correcta lubricación garantiza el buen funcionamiento de las roscas.  
No lo olvide
- Une correcte lubrification vous garantit l'utilisation correcte des filetages.  
Ne l'oubliez pas
- A correct lubricating guarantees you a correct use of the threads.  
Do not forget it
- Una corretta lubrificazione vi garantisce un corretto utilizzo delle filettature.  
Non dimenticatelo



# Racores JIC 37°

Raccords JIC 37°  
JIC 37° fittings  
Raccordi JIC 37°

# 4

Racores JIC 37°

Raccords JIC 37° | JIC 37° fittings | Raccordi JIC 37°

190

## Racores JIC 37°

Raccords JIC 37° | JIC 37° fittings | Raccordi JIC 37°

Pipe

### Tuercas y férulas JIC 37° | Écrous et Ferrules JIC 37° | Nuts and Sleeves | Dadi e Bussole JIC 37°

193

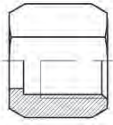

S110

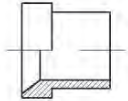

S120

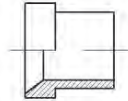

S120-W

DIN 2353 Pipe Fittings

### Tapones JIC 37° | Bouchons JIC 37° | JIC 37° Plugs | Tappi JIC 37°

193



S130

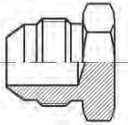

S140

Gas tube fittings

### Uniones rectas JIC 37° | Unions droites JIC 37° | JIC 37° Straight union | Adattatori diritti JIC 37°

194

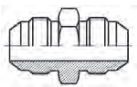

S260



S730

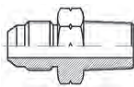

S200

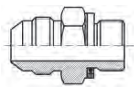

S230

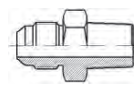

S210

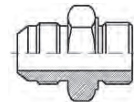

S220



S250

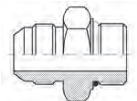

S240

JIC 37° fittings

### Uniones macho-hembra JIC 37° | Unions mâle JIC 37° x femelle JIC 37° | JIC 37° Male-female unions | Adattatori maschio-femmina JIC 37°

196

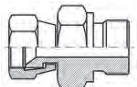

S180

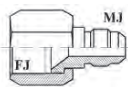

S290

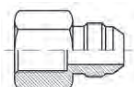

S280

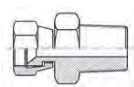

S150

SAE Flanges

### Codos JIC 37° | Coudes JIC 37° | JIC 37° Elbows | Adattatori a 45° e 90° JIC 37°

197

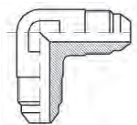

S500

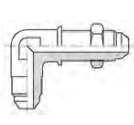

S650



S550

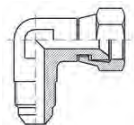

S675

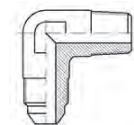

S525



S690

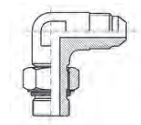

S600

Clamps

### Tes y Cruz JIC 37° | Tés et Croix JIC 37° | JIC 37° Tees and Crosses | Adattatori a T e Croci JIC 37°

199



S505



S680



S685

Machines for processing rigid pipes

► **Tes orientable JIC 37°** | Tés orientables JIC 37° | JIC 37° Banjo Tees | Adattatori a T orientabili

199

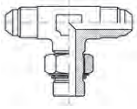

S610

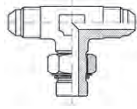

S585

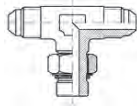

S635



S605



S580



S630

Pipe

DIN 2353 Pipe Fittings

Gas tube fittings

JIC 37° fittings

SAE Flanges

Clamps

Machines for processing rigid pipes





## Racores JIC 37°

Raccords JIC 37°  
JIC 37° fittings  
Raccordi JIC 37°

### Tuercas JIC 37°



Écrous JIC 37°  
JIC 37° Nuts  
Dado JIC 37°

TUBO PIPE	ROSCA THREAD	REFERENCIA PART N°	€	
6	1/4	7/16" 20h UNF	<b>S11006</b>	<b>0,74</b>
8	5/16	1/2" 20h UNF	<b>S11008</b>	<b>0,91</b>
10	3/8	9/16" 18h UNF	<b>S11010</b>	<b>0,99</b>
12	1/2	3/4" 16h UNF	<b>S11012</b>	<b>1,32</b>
14-15-16	5/8	7/8" 14h UNF	<b>S11016</b>	<b>1,48</b>
18-20	-	1" 1/16 12h UNF	<b>S11020</b>	<b>2,55</b>
-	3/4	1" 1/16 12h UNF	<b>S11020W</b>	<b>2,55</b>
25	1	1" 5/16 12h UNF	<b>S11025</b>	<b>3,54</b>
30-32	1 1/4	1" 5/8 12h UNF	<b>S11032</b>	<b>7,82</b>
38	1 1/2	1" 7/8 12h UNF	<b>S11038</b>	<b>12,10</b>

### Férulas JIC 37° (Tubo métrico)

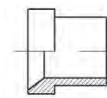

Ferrules JIC 37° pour tube Métrique  
JIC 37° sleeves Metric tube  
Bussola JIC 37° (tubo Metrico)

TUBO PIPE	REFERENCIA PART N°	€
6	<b>S12006</b>	<b>0,47</b>
8	<b>S12008</b>	<b>0,55</b>
10	<b>S12010</b>	<b>0,61</b>
12	<b>S12012</b>	<b>0,70</b>
14	<b>S12014</b>	<b>1,05</b>
15	<b>S12015</b>	<b>1,08</b>
16	<b>S12016</b>	<b>1,02</b>
18	<b>S12018</b>	<b>1,60</b>
20	<b>S12020</b>	<b>1,57</b>
25	<b>S12025</b>	<b>2,10</b>
30	<b>S12030</b>	<b>4,17</b>
32	<b>S12032</b>	<b>4,75</b>
38	<b>S12038</b>	<b>10,20</b>

### Férulas JIC 37° (Tubo Gas)

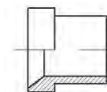

Ferrules JIC 37° pour tube Gaz  
37° JIC sleeves Gas tube  
Bussola JIC 37° (tubo Gas)

TUBO PIPE	REFERENCIA PART N°	€
1/4	<b>S12006W</b>	<b>0,47</b>
5/16	<b>S12008W</b>	<b>0,55</b>
3/8	<b>S12010W</b>	<b>0,61</b>
1/2	<b>S12012W</b>	<b>0,70</b>
5/8	<b>S12016W</b>	<b>1,02</b>
3/4	<b>S12020W</b>	<b>1,57</b>
1	<b>S12025W</b>	<b>2,39</b>
1 1/4	<b>S12032W</b>	<b>4,75</b>
1 1/2	<b>S12038W</b>	<b>10,20</b>

### Tapón hembra JIC 37°



Obturbateur femelle JIC 37° pour raccord  
37° JIC Female plug  
Tappo femmina girevole JIC 37°

TUBO PIPE	ROSCA THREAD	REFERENCIA PART N°	€
6	7/16" 20h UNF	<b>S13006</b>	<b>1,33</b>
8	1/2" 20h UNF	<b>S13008</b>	<b>1,90</b>
10	9/16" 18h UNF	<b>S13010</b>	<b>2,00</b>
12	3/4" 16h UNF	<b>S13012</b>	<b>2,66</b>
14-15-16	7/8" 14h UNF	<b>S13016</b>	<b>3,43</b>
18-20	1" 1/16 12h UNF	<b>S13020</b>	<b>4,76</b>
25	1" 5/16 12h UNF	<b>S13025</b>	<b>8,09</b>
30-32	1" 5/8 12h UNF	<b>S13032</b>	<b>13,80</b>
38	1" 7/8 12h UNF	<b>S13038</b>	<b>26,93</b>

### Tapón macho JIC 37°

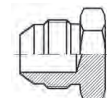

Bouchon mâle JIC 37°  
37° JIC Male plug  
Tappo maschio JIC 37°

TUBO PIPE	ROSCA THREAD	REFERENCIA PART N°	€
6	7/16" 20h UNF	<b>S14006</b>	<b>1,14</b>
8	1/2" 20h UNF	<b>S14008</b>	<b>1,33</b>
10	9/16" 18h UNF	<b>S14010</b>	<b>1,33</b>
12	3/4" 16h UNF	<b>S14012</b>	<b>1,52</b>
14-15-16	7/8" 14h UNF	<b>S14016</b>	<b>1,71</b>
18-20	1" 1/16 12h UNF	<b>S14020</b>	<b>2,95</b>
25	1" 5/16 12h UNF	<b>S14025</b>	<b>4,00</b>
30-32	1" 5/8 12h UNF	<b>S14032</b>	<b>7,14</b>
38	1" 7/8 12h UNF	<b>S14038</b>	<b>25,37</b>

## Racores JIC 37°

Raccords JIC 37°  
JIC 37° fittings  
Raccordi JIC 37°

Pipe

DIN 2353 Pipe Fittings

Gas tube fittings

JIC 37° fittings

SAE Flanges

Clamps

Machines for  
processing rigid pipes

### Racor macho-macho JIC 37°

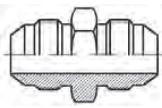

Adapteur droit mâle JIC x mâle JIC

Straight union

Niples di giunzione maschio-maschio JIC 37°

TUBO PIPE		ROSCA THREAD	REFERENCIA PART N°	€
6	1/4	7/16" 20h UNF	S26006	1,15
8	5/16	1/2" 20h UNF	S26008	1,23
10	3/8	9/16" 18h UNF	S26010	1,32
12	1/2	3/4" 16h UNF	S26012	1,56
14-15-16	5/8	7/8" 14h UNF	S26016	2,31
18-20	3/4	1" 1/16 12h UNF	S26020	3,05
25	1	1" 5/8 12h UNF	S26025	5,35
30-32	1 1/4	1" 5/8 12h UNF	S26032	8,64
38	1 1/2	1" 7/8 12h UNF	S26038	14,90

### Racor hembra giratoria- hembra giratoria JIC 37°

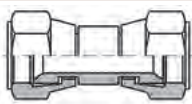

Adapteur femelle tournante JIC x femelle tournante JIC

Straight fitting with crimped nut

Niples femmina-femmina girevole JIC 37°

TUBO PIPE		ROSCA THREAD	REFERENCIA PART N°	€
6	1/4	7/16" 20h UNF	S73006	3,70
8	5/16	1/2" 20h UNF	S73008	5,76
10	3/8	9/16" 18h UNF	S73010	4,77
12	1/2	3/4" 16h UNF	S73012	8,64
14-15-16	5/8	7/8" 14h UNF	S73016	9,30
18-20	3/4	1" 1/16 12h UNF	S73020	9,80
25	1	1" 5/8 12h UNF	S73025	15,89

### Racor macho JIC 37° - macho NPT

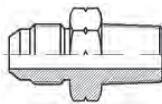

Adapteur mâle JIC x mâle NPT

Straight adaptor male JIC-male NPT

Niples di giunzione JIC 37°-NPT

TUBO PIPE		ROSCA THREAD		REF. PART N°	€
6	1/4	1/8" NPT	7/16" 20h UNF	S2000610	1,15
6	1/4	1/4" NPT	7/16" 20h UNF	S2000613	1,15
8	5/16	1/8" NPT	1/2" 20h UNF	S2000810	2,78
8	5/16	1/4" NPT	1/2" 20h UNF	S2000813	1,40
10	3/8	1/4" NPT	9/16" 18h UNF	S2001013	1,48
10	3/8	3/8" NPT	9/16" 18h UNF	S2001017	1,56
12	1/2	3/8" NPT	3/4" 16h UNF	S2001217	2,31
12	1/2	1/2" NPT	3/4" 16h UNF	S2001221	2,31
12	1/2	3/4" NPT	3/4" 16h UNF	S2001226	7,47
14-15-16	5/8	1/2" NPT	7/8" 14h UNF	S2001621	3,08
14-15-16	5/8	3/4" NPT	7/8" 14h UNF	S2001626	3,95
18-20	3/4	1/2" NPT	1" 1/16 12h UNF	S2002021	3,44
18-20	3/4	3/4" NPT	1" 1/16 12h UNF	S2002026	5,77
18-20	3/4	1" NPT	1" 1/16 12h UNF	S2002033	12,27
25	1	3/4" NPT	1" 5/8 12h UNF	S2002526	12,90
25	1	1" NPT	1" 5/8 12h UNF	S2002533	6,17
32	1 1/4	1" NPT	1" 5/8 12h UNF	S2003233	26,47
32	1 1/4	1" 1/4 NPT	1" 5/8 12h UNF	S2003242	22,27
38	1 1/2	1" 1/4 NPT	1" 7/8 12h UNF	S2003842	38,61
38	1 1/2	1" 1/2 NPT	1" 7/8 12h UNF	S2003848	35,62

### Racor macho JIC 37° - macho BSP

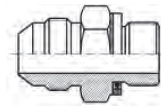

Adapteur mâle JIC x mâle gaz cyl équipé

Straight adaptor male JIC-male BSP

Niples di giunzione JIC37° -BSP

TUBO PIPE		ROSCA THREAD		REF. PART N°	€
6	1/4	1/8" BSP	7/16" 20h UNF	S2300610	1,07
6	1/4	1/4" BSP	7/16" 20h UNF	S2300613	1,30
6	1/4	3/8" BSP	7/16" 20h UNF	S2300617	1,66
8	5/16	1/4" BSP	1/2" 20h UNF	S2300813	1,65
8	5/16	3/8" BSP	1/2" 20h UNF	S2300817	1,81
10	3/8	1/4" BSP	9/16" 18h UNF	S2301013	1,30
10	3/8	3/8" BSP	9/16" 18h UNF	S2301017	1,65
10	3/8	1/2" BSP	9/16" 18h UNF	S2301021	2,88
12	1/2	1/4" BSP	3/4" 16h UNF	S2301213	1,32
12	1/2	3/8" BSP	3/4" 16h UNF	S2301217	1,59
12	1/2	1/2" BSP	3/4" 16h UNF	S2301221	2,31
12	1/2	3/4" BSP	3/4" 16h UNF	S2301226	2,96
14-15-16	5/8	3/8" BSP	7/8" 14h UNF	S2301617	1,73
14-15-16	5/8	1/2" BSP	7/8" 14h UNF	S2301621	2,31
14-15-16	5/8	3/4" BSP	7/8" 14h UNF	S2301626	4,36
18-20	3/4	1/2" BSP	1" 1/16 12h UNF	S2302021	3,38
18-20	3/4	3/4" BSP	1" 1/16 12h UNF	S2302026	4,94
18-20	3/4	1" BSP	1" 1/16 12h UNF	S2302033	6,83
25	1	3/4" BSP	1" 5/8 12h UNF	S2302526	5,35
25	1	1" BSP	1" 5/8 12h UNF	S2302533	6,26
25	1	1" 1/4 BSP	1" 5/8 12h UNF	S2302542	9,63
30-32	1 1/4	1" 1/4 BSP	1" 5/8 12h UNF	S2303242	10,29
38	1 1/2	1" 1/4 BSP	1" 7/8 12h UNF	S2303842	11,44
38	1 1/2	1" 1/2 BSP	1" 7/8 12h UNF	S2303848	21,89

### Racor macho JIC 37° - macho BSPT



Adapteur mâle JIC x mâle gaz conique

Straight adaptor male JIC-male BSPT

Niples di giunzione JIC 37°-BSPT

TUBO PIPE		ROSCA THREAD		REF. PART N°	€
6	1/4	1/8" BSPT	7/16" 20h UNF	S2100610	0,74
6	1/4	1/4" BSPT	7/16" 20h UNF	S2100613	1,15
8	5/16	1/8" BSPT	1/2" 20h UNF	S2100810	0,91
8	5/16	1/4" BSPT	1/2" 20h UNF	S2100813	0,99
10	3/8	1/4" BSPT	9/16" 18h UNF	S2101013	1,23
10	3/8	3/8" BSPT	9/16" 18h UNF	S2101017	1,32
10	3/8	1/2" BSPT	9/16" 18h UNF	S2101021	1,65
12	1/2	1/4" BSPT	3/4" 16h UNF	S2101213	1,56
12	1/2	3/8" BSPT	3/4" 16h UNF	S2101217	1,98
12	1/2	1/2" BSPT	3/4" 16h UNF	S2101221	1,98
14-15-16	5/8	3/8" BSPT	7/8" 14h UNF	S2101617	2,63
14-15-16	5/8	1/2" BSPT	7/8" 14h UNF	S2101621	2,63
14-15-16	5/8	3/4" BSPT	7/8" 14h UNF	S2101626	2,31
18-20	3/4	1/2" BSPT	1" 1/16 12h UNF	S2102021	2,88
18-20	3/4	3/4" BSPT	1" 1/16 12h UNF	S2102026	3,08
25	1	3/4" BSPT	1" 5/8 12h UNF	S2102526	5,35
25	1	1" BSPT	1" 5/8 12h UNF	S2102533	5,08
30-32	1 1/4	1" BSPT	1" 5/8 12h UNF	S2103233	23,07
30-32	1 1/4	1 1/4" BSPT	1" 5/8 12h UNF	S2103242	21,85
38	1 1/2	1 1/2" BSPT	1" 7/8 12h UNF	S2103848	30,24

## Racores JIC 37°

Raccords JIC 37°  
JIC 37° fittings  
Raccordi JIC 37°

### Racor macho JIC 37° - macho UNF

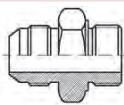

Adaptateur mâle JIC x mâle UNF équipé

Straight adaptor male JIC-male UNF

Niples di giunzione JIC 37°-UNF

TUBO PIPE		ROSCA THREAD		REF. PART N°	€
6	1/4	7/16" 20h JIC	7/16" 20h UNF	S2200611	0,99
6	1/4	7/16" 20h JIC	1/2" 20h UNF	S2200612	1,23
6	1/4	7/16" 20h JIC	9/16" 18h UNF	S2200614	1,15
8	5/16	1/2" 20h JIC	1/2" 20h UNF	S2200812	1,15
10	3/8	9/16" 18h JIC	9/16" 18h UNF	S2201014	1,40
10	3/8	9/16" 18h JIC	3/4" 16h UNF	S2201019	1,65
12	1/2	3/4" 16h JIC	3/4" 16h UNF	S2201219	2,31
12	1/2	3/4" 16h JIC	7/8" 14h UNF	S2201222	2,96
14-15-16	5/8	7/8" 14h JIC	7/8" 14h UNF	S2201622	2,96
14-15-16	5/8	7/8" 14h JIC	1"1/16 12h UNF	S2201627	4,53
18-20	3/4	1"1/16 12h JIC	3/4" 16h UNF	S2202019	3,79
18-20	3/4	1"1/16 12h JIC	7/8" 14h UNF	S2202022	3,95
18-20	3/4	1"1/16 12h JIC	1"1/16 12h UNF	S2202027	4,77
18-20	3/4	1"1/16 12h JIC	1"5/16 12h UNF	S2202033	5,52
25	1	1"5/16 12h JIC	1"1/16 12h UNF	S2202527	9,35
25	1	1"5/16 12h JIC	1"5/16 12h UNF	S2202533	5,10
25	1	1"5/16 12h JIC	1"5/8 12h UNF	S2202541	27,08
30-32	1 1/4	1"5/8 12h JIC	1"5/8 12h UNF	S2203241	8,02
38	1 1/2	1"7/8 12h JIC	1"7/8 12h UNF	S2203848	30,36

### Racor pasatabiques JIC 37°

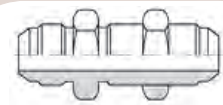

Union passe cloison droite mâle JIC x mâle JIC équipé

Straight bulkhead fitting

Niples passaparete JIC 37°

TUBO PIPE		ROSCA THREAD		REFERENCIA PART N°	€
6	1/4	7/16" 20h UNF		S25006	2,06
8	5/16	1/2" 20h UNF		S25008	2,72
10	3/8	9/16" 18h UNF		S25010	3,05
12	1/2	3/4" 16h UNF		S25012	3,79
14-15-16	5/8	7/8" 14h UNF		S25016	4,77
18-20	3/4	1"1/16 12h UNF		S25020	7,16
25	1	1"5/16 12h UNF		S25025	8,15
30-32	1 1/4	1"5/8 12h UNF		S25032	17,37
38	1 1/2	1"7/8 12h UNF		S25038	52,06

### Racor macho JIC 37° - macho Métrico

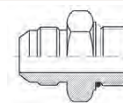

Adaptateur mâle JIC x mâle Métrique équipé

Metric adaptor male-male JIC

Niples di giunzione JIC 37°-Metrico

TUBO PIPE		ROSCA THREAD		REF. PART N°	€
6	1/4	7/16" 20h UNF	M10X1	S2400610	2,47
8	5/16	1/2" 20h UNF	M12X1.5	S2400812	2,63
10	3/8	9/16" 18h UNF	M14X1.5	S2401014	3,29
12	1/2	3/4" 16h UNF	M16X1.5	S2401216	2,80
12	1/2	3/4" 16h UNF	M18X1.5	S2401218	3,29
14-15-16	5/8	7/8" 14h UNF	M18X1.5	S2401418	3,79
14-15-16	5/8	7/8" 14h UNF	M22X1.5	S2401622	4,12
20	3/4	1"1/16 12h UNF	M18X1.5	S2402018	6,42
18-20	3/4	1"1/16 12h UNF	M22X1.5	S2402022	6,42
18-20	3/4	1"1/16 12h UNF	M27X2	S2402027	8,40
25	1	1"5/16 12h UNF	M33X2	S2402533	10,60
30-32	1 1/4	1"5/8 12h UNF	M42X2	S2403242	29,93

## Racores JIC 37°

Raccords JIC 37°  
JIC 37° fittings  
Raccordi JIC 37°

Pipe

DIN 2353 Pipe Fittings

Gas tube fittings

JIC 37° fittings

SAE Flanges

Clamps

Machines for  
processing rigid pipes

### Racor macho BSP - hembra giratoria JIC 37°

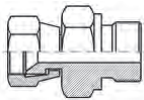

Adapteur femelle tournante JIC x mâle gaz cyl équipé  
Adaptor swivel nut JIC-male BSP  
Niples maschio-femmina BSP-JIC 37°

TUBO PIPE		ROSCA THREAD		REF. PART N°	€
6	1/4	M 1/8" BSP	H 7/16" 20h UNF	<b>S1800610</b>	<b>3,24</b>
8	5/16	M 1/4" BSP	H 1/2" 20h UNF	<b>S1800813</b>	<b>4,09</b>
10	3/8	M 1/4" BSP	H 9/16" 18h UNF	<b>S1801013</b>	<b>4,85</b>
10	3/8	M 3/8" BSP	H 9/16" 18h UNF	<b>S1801017</b>	<b>5,99</b>
12	1/2	M 3/8" BSP	H 3/4" 16h UNF	<b>S1801217</b>	<b>6,37</b>
14-15-16	5/8	M 1/2" BSP	H 7/8" 14h UNF	<b>S1801621</b>	<b>8,66</b>
18-20	3/4	M 3/4" BSP	H 1"1/16 12h UNF	<b>S1802026</b>	<b>9,99</b>
25	1	M 1" BSP	H 1"5/16 12h UNF	<b>S1802533</b>	<b>14,46</b>
30-32	1 1/4	M 1"1/4 BSP	H 1"5/8 12h UNF	<b>S1803242</b>	<b>22,64</b>
38	1 1/2	M 1"1/2 BSP	H 1"7/8 12h UNF	<b>S1803848</b>	<b>79,76</b>

### Racor macho JIC 37° - hembra fija BSP

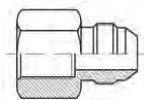

Adapteur mâle JIC x femelle gaz cyl  
Adaptor male JIC 37°-fixed female BSP  
Niples maschio-femmina JIC 37°-BSP

TUBO PIPE		ROSCA THREAD		REF. PART N°	€
6	1/4	M 7/16" 20h UNF	H 1/8" BSP	<b>S2800610</b>	<b>4,88</b>
6	1/4	M 7/16" 20h UNF	H 1/4" BSP	<b>S2800613</b>	<b>4,39</b>
8	5/16	M 1/2" 20h UNF	H 1/8" BSP	<b>S2800810</b>	<b>4,88</b>
8	5/16	M 1/2" 20h UNF	H 1/4" BSP	<b>S2800813</b>	<b>4,88</b>
10	3/8	M 9/16" 18h UNF	H 1/4" BSP	<b>S2801013</b>	<b>4,88</b>
10	3/8	M 9/16" 18h UNF	H 3/8" BSP	<b>S2801017</b>	<b>4,88</b>
12	1/2	M 3/4" 16h UNF	H 3/8" BSP	<b>S2801217</b>	<b>4,88</b>
12	1/2	M 3/4" 16h UNF	H 1/2" BSP	<b>S2801221</b>	<b>5,91</b>
14-15-16	5/8	M 7/8" 14h UNF	H 1/2" BSP	<b>S2801621</b>	<b>5,91</b>
18-20	3/4	M 1"1/16 12h UNF	H 1/2" BSP	<b>S2802021</b>	<b>8,17</b>
18-20	3/4	M 1"1/16 12h UNF	H 3/4" BSP	<b>S2802026</b>	<b>8,17</b>
25	1	M 1"5/16 12h UNF	H 1" BSP	<b>S2802533</b>	<b>17,09</b>
30-32	1 1/4	M 1"5/8 12h UNF	H 1"1/4 BSP	<b>S2803242</b>	<b>32,07</b>
38	1 1/2	M 1"7/8 12h UNF	H 1"1/2 BSP	<b>S2803848</b>	<b>45,32</b>

### Racor unión macho-hembra JIC 37°

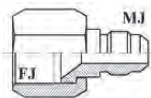

Reducteur mâle JIC x femelle JIC  
Reducer adaptor JIC-JIC  
Riduzione maschio-femmina JIC 37°

TUBO PIPE		ROSCA THREAD		REF. PART N°	€
10	6	H 9/16" 18h UNF	M 7/16" 20h UNF	<b>S2901006</b>	<b>4,26</b>
12	6	H 3/4" 16h UNF	M 7/16" 20h UNF	<b>S2901206</b>	<b>4,10</b>
8	12	H 3/4" 16h UNF	M 1/2" 20h UNF	<b>S2901208</b>	<b>7,34</b>
12	10	H 3/4" 16h UNF	M 9/16" 18h UNF	<b>S2901210</b>	<b>7,49</b>
14-15-16	6	H 7/8" 14h UNF	M 7/16" 20h UNF	<b>S2901606</b>	<b>8,18</b>
14-15-16	10	H 7/8" 14h UNF	M 9/16" 18h UNF	<b>S2901610</b>	<b>8,95</b>
14-15-16	12	H 7/8" 14h UNF	M 3/4" 16h UNF	<b>S2901612</b>	<b>10,83</b>
18-20	6	H 1"1/16 12h UN	M 7/16" 20h UNF	<b>S2902006</b>	<b>9,51</b>
18-20	12	H 1"1/16 12h UN	M 3/4" 16h UNF	<b>S2902012</b>	<b>8,95</b>
25	18-20	H 1"5/16 12h UN	M 1"1/16 12h UN	<b>S2902520</b>	<b>13,45</b>
30-32	25	H 1"5/8 12h UN	M 1"5/16 12h UN	<b>S2903225</b>	<b>14,27</b>
38	30-32	H 1"7/8 12h UN	M 1"5/8 12h UN	<b>S2903832</b>	<b>29,40</b>

### Racor macho BSPT - hembra giratoria JIC 37°

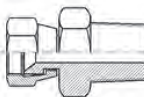

Adapteur femelle tournante JIC x mâle gaz conique  
Adaptor male BSPT-swivel female JIC 37°  
Niples maschio-femmina BSPT-JIC 37°

TUBO PIPE		ROSCA THREAD		REF. PART N°	€
6	1/4	M 1/4" BSPT	H 7/16" 20h UNF	<b>S1500613</b>	<b>7,52</b>
8	5/16	M 1/4" BSPT	H 1/2" 20h UNF	<b>S1500813</b>	<b>7,73</b>
10	3/8	M 1/4" BSPT	H 9/16" 18h UNF	<b>S1501013</b>	<b>7,52</b>
12	1/2	M 1/4" BSPT	H 3/4" 16h UNF	<b>S1501213</b>	<b>9,27</b>
12	1/2	M 3/8" BSPT	H 3/4" 16h UNF	<b>S1501217</b>	<b>8,77</b>
16	5/8	M 1/2" BSPT	H 7/8" 14h UNF	<b>S1501621</b>	<b>12,58</b>
20	3/4	M 1/2" BSPT	H 1"1/16 12h UNF	<b>S1502021</b>	<b>14,22</b>
20	3/4	M 3/4" BSPT	H 1"1/16 12h UNF	<b>S1502026</b>	<b>14,54</b>
25	1	M 3/4" BSPT	H 1"5/16 12h UNF	<b>S1502526</b>	<b>30,22</b>
25	1	M 1" BSPT	H 1"5/16 12h UNF	<b>S1502533</b>	<b>27,97</b>
32	1 1/4	M 1"1/4 BSPT	H 1"5/8 12h UNF	<b>S1503242</b>	<b>42,48</b>

## Racores JIC 37°

Raccords JIC 37°  
JIC 37° fittings  
Raccordi JIC 37°

### Codo 90° macho - macho JIC 37°

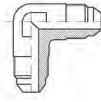

Adaptateur coude 90° mâle JIC 37° x mâle JIC 37°

90° Male elbow male JIC 37°-male JIC 37°

Adattatore a 90° maschio-maschio JIC 37°

TUBO PIPE	ROSCA THREAD	REFERENCIA PART N°	€
6	1/4	7/16" 20h UNF	<b>S50006</b> 2,47
8	5/16	1/2" 20h UNF	<b>S50008</b> 3,38
10	3/8	9/16" 18h UNF	<b>S50010</b> 2,88
12	1/2	3/4" 16h UNF	<b>S50012</b> 3,87
14-15-16	5/8	7/8" 14h UNF	<b>S50016</b> 5,19
18-20	3/4	1"1/16 12h UNF	<b>S50020</b> 8,15
25	1	1"5/16 12h UNF	<b>S50025</b> 11,03
30-32	1 1/4	1"5/8 12h UNF	<b>S50032</b> 35,41
38	1 1/2	1"7/8 12h UNF	<b>S50038</b> 51,27

### Codo 90° pasatabiques JIC 37°

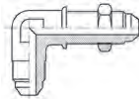

Adaptateur coude 90° passe cloison mâle JIC 37° x mâle JIC 37° équipé

90° Bulkhead coupling male JIC 37°-male JIC 37°

Adattatore a 90° passaparete maschio-maschio JIC 37°

TUBO PIPE	ROSCA THREAD	REFERENCIA PART N°	€
6	1/4	7/16" 20h UNF	<b>S65006</b> 3,79
8	5/16	1/2" 20h UNF	<b>S65008</b> 3,54
10	3/8	9/16" 18h UNF	<b>S65010</b> 3,70
12	1/2	3/4" 16h UNF	<b>S65012</b> 5,02
14-15-16	5/8	7/8" 14h UNF	<b>S65016</b> 7,24
18-20	3/4	1"1/16 12h UNF	<b>S65020</b> 12,59
25	1	1"5/16 12h UNF	<b>S65025</b> 23,71

### Codo 90° macho JIC 37° - macho BSPT



Adaptateur coude 90° mâle JIC 37° x mâle gaz conique

90° male elbow male JIC 37° -male BSPT

Adattatore a 90° maschio-maschio JIC 37°-BSPT

TUBO PIPE	ROSCA THREAD	REF. PART N°	€
6	1/4	7/16" 20h UNF	1/8" BSPT <b>S5500610</b> 7,52
6	1/4	7/16" 20h UNF	1/4" BSPT <b>S5500613</b> 7,60
8	5/16	1/2" 20h UNF	1/8" BSPT <b>S5500810</b> 8,39
8	5/16	1/2" 20h UNF	1/4" BSPT <b>S5500813</b> 7,44
10	3/8	9/16" 18h UNF	1/4" BSPT <b>S5501013</b> 6,96
10	3/8	9/16" 18h UNF	3/8" BSPT <b>S5501017</b> 7,84
10	3/8	9/16" 18h UNF	1/2" BSPT <b>S5501021</b> 11,77
12	1/2	3/4" 16h UNF	1/4" BSPT <b>S5501213</b> 12,16
12	1/2	3/4" 16h UNF	3/8" BSPT <b>S5501217</b> 7,97
12	1/2	3/4" 16h UNF	1/2" BSPT <b>S5501221</b> 10,49
14-15-16	5/8	7/8" 14h UNF	3/8" BSPT <b>S5501617</b> 12,24
14-15-16	5/8	7/8" 14h UNF	1/2" BSPT <b>S5501621</b> 9,64
14-15-16	5/8	7/8" 14h UNF	3/4" BSPT <b>S5501626</b> 18,46
18-20	3/4	1"1/16 12h UNF	1/2" BSPT <b>S5502021</b> 19,16
18-20	3/4	1"1/16 12h UNF	3/4" BSPT <b>S5502026</b> 16,55
25	1	1"5/16 12h UNF	3/4" BSPT <b>S5502526</b> 29,82
25	1	1"5/16 12h UNF	1" BSPT <b>S5502533</b> 24,73
30-32	1 1/4	1"5/8 12h UNF	1" BSPT <b>S5503233</b> 34,88
30-32	1 1/4	1"5/8 12h UNF	1 1/4" BSPT <b>S5503242</b> 35,94
38	1 1/2	1"7/8 12h UNF	1"1/2 BSPT <b>S5503848</b> 83,17

### Codo 90° macho - hembra giratoria JIC 37°

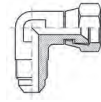

Adaptateur coude 90° mâle JIC 37° x femelle tournante JIC 37°

90° Elbow swivel nut JIC 37°-male JIC 37°

Adattatore a 90° maschio-femmina girevole JIC 37°

TUBO PIPE	ROSCA THREAD	REFERENCIA PART N°	€
6	1/4	7/16" 20h UNF	<b>S67506</b> 3,38
8	5/16	1/2" 20h UNF	<b>S67508</b> 4,36
10	3/8	9/16" 18h UNF	<b>S67510</b> 4,61
12	1/2	3/4" 16h UNF	<b>S67512</b> 6,50
14-15-16	5/8	7/8" 14h UNF	<b>S67516</b> 6,75
18-20	3/4	1"1/16 12h UNF	<b>S67520</b> 7,98
25	1	1"5/16 12h UNF	<b>S67525</b> 18,19
30-32	1 1/4	1"5/8 12h UNF	<b>S67532</b> 56,55
38	1 1/2	1"7/8 12h UNF	<b>S67538</b> 43,87

### Codo 90° macho JIC 37° - macho NPT

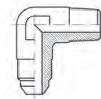

Adaptateur coude 90° mâle JIC 37° x mâle NPT

90° Male elbow male JIC 37°-male NPT

Adattatore a 90° maschio-maschio JIC 37°-NPT

TUBO PIPE	ROSCA THREAD	REF. PART N°	€
6	1/4	7/16" 20h UNF	1/8" NPT <b>S5250610</b> 6,70
6	1/4	7/16" 20h UNF	1/4" NPT <b>S5250613</b> 6,81
8	5/16	1/2" 20h UNF	1/8" NPT <b>S5250810</b> 5,93
8	5/16	1/2" 20h UNF	1/4" NPT <b>S5250813</b> 6,57
10	3/8	9/16" 18h UNF	1/4" NPT <b>S5251013</b> 6,57
10	3/8	9/16" 18h UNF	3/8" NPT <b>S5251017</b> 6,78
10	3/8	9/16" 18h UNF	1/2" NPT <b>S5251021</b> 10,67
12	1/2	3/4" 16h UNF	1/4" NPT <b>S5251213</b> 9,91
12	1/2	3/4" 16h UNF	3/8" NPT <b>S5251217</b> 7,49
12	1/2	3/4" 16h UNF	1/2" NPT <b>S5251221</b> 9,08
14-15-16	5/8	7/8" 14h UNF	3/8" NPT <b>S5251617</b> 11,15
14-15-16	5/8	7/8" 14h UNF	1/2" NPT <b>S5251621</b> 11,15
14-15-16	5/8	7/8" 14h UNF	3/4" NPT <b>S5251626</b> 19,16
18-20	3/4	1"1/16 12h UNF	1/2" NPT <b>S5252021</b> 15,55
18-20	3/4	1"1/16 12h UNF	3/4" NPT <b>S5252026</b> 12,63
25	1	1"5/16 12h UNF	3/4" NPT <b>S5252526</b> 23,07
25	1	1"5/16 12h UNF	1" NPT <b>S5252533</b> 23,12
30-32	1 1/4	1"5/8 12h UNF	1" NPT <b>S5253233</b> 37,29
30-32	1 1/4	1"5/8 12h UNF	1 1/4" NPT <b>S5253242</b> 37,29
38	1 1/2	1"7/8 12h UNF	1"1/2 NPT <b>S5253848</b> 62,13

### Codo 45° macho - hembra giratoria JIC 37°



Adaptateur coude 45° mâle JIC 37° x femelle tournante JIC 37°

45° Elbow male-swivel nut JIC 37°

Adattatore a 45° maschio-femmina girevole JIC 37°

TUBO PIPE	ROSCA THREAD	REFERENCIA PART N°	€
6	1/4	7/16" 20h UNF	<b>S69006</b> 3,70
8	5/16	1/2" 20h UNF	<b>S69008</b> 4,69
10	3/8	9/16" 18h UNF	<b>S69010</b> 5,10
12	1/2	3/4" 16h UNF	<b>S69012</b> 6,26
14-15-16	5/8	7/8" 14h UNF	<b>S69016</b> 8,40
18-20	3/4	1"1/16 12h UNF	<b>S69020</b> 10,78
25	1	1"5/16 12h UNF	<b>S69025</b> 18,11

## Racores JIC 37°

Raccords JIC 37°  
JIC 37° fittings  
Raccordi JIC 37°

Pipe

DIN 2353 Pipe Fittings

Gas tube fittings

JIC 37° fittings

SAE Flanges

Clamps

Machines for  
processing rigid pipes

### Codo 90° macho JIC 37° - macho BSP orientable



Adaptateur orientable coude 90° mâle JIC 37° x mâle gaz cyl + o'ring équipé  
90° Banjo elbow male JIC 37°-BSP Banjo male  
Adattatore a 90° maschio-maschio orientabile JIC 37°-BSP

TUBO PIPE		ROSCA THREAD		REF. PART N°	€
6	1/4	7/16" 20h UNF	1/8" BSP	S6000610	3,13
6	1/4	7/16" 20h UNF	1/4" BSP	S6000613	3,87
8	5/16	1/2" 20h UNF	1/8" BSP	S6000810	3,70
8	5/16	1/2" 20h UNF	1/4" BSP	S6000813	4,53
10	3/8	9/16" 18h UNF	1/4" BSP	S6001013	4,53
10	3/8	9/16" 18h UNF	3/8" BSP	S6001017	4,77
10	3/8	9/16" 18h UNF	1/2" BSP	S6001021	12,50
12	1/2	3/4" 16h UNF	1/4" BSP	S6001213	5,19
12	1/2	3/4" 16h UNF	3/8" BSP	S6001217	5,52
12	1/2	3/4" 16h UNF	1/2" BSP	S6001221	6,50
16	5/8	7/8" 14h UNF	3/8" BSP	S6001617	7,00
14-15-16	5/8	7/8" 14h UNF	1/2" BSP	S6001621	7,08
18-20	3/4	1"1/16 12h UNF	1/2" BSP	S6002021	9,80
18-20	3/4	1"1/16 12h UNF	3/4" BSP	S6002026	9,55
18-20	3/4	1"1/16 12h UNF	1" BSP	S6002033	15,80
25	1	1"5/16 12h UNF	3/4" BSP	S6002526	15,23
25	1	1"5/16 12h UNF	1" BSP	S6002533	17,04
30-32	1 1/4	1"5/8 12h UNF	1" BSP	S6003233	23,13
30-32	1 1/4	1"5/8 12h UNF	1"1/4 BSP	S6003242	28,85
38	1 1/2	1"7/8 12h UNF	1"1/4 BSP	S6003842	69,94
38	1 1/2	1"7/8 12h UNF	1"1/2 BSP	S6003848	66,63

### Codo 45° macho JIC 37° - macho BSP orientable

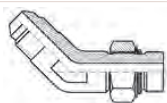

Adaptateur coude 45° mâle JIC 37° x mâle gaz cyl + o'ring équipé  
45° Elbow male JIC 37°-BSP Banjo male  
Adattatore a 45° maschio JIC 37°-maschio BSP orientabile

TUBO PIPE		ROSCA THREAD		REF. PART N°	€
8	5/16	1/2" 20h UNF	1/4" BSP	S6150813	3,95
10	3/8	9/16" 18h UNF	1/4" BSP	S6151013	4,77
12	1/2	3/4" 16h UNF	3/8" BSP	S6151217	6,01
12	1/2	3/4" 16h UNF	1/2" BSP	S6151221	6,67
14-15-16	5/8	7/8" 14h UNF	1/2" BSP	S6151621	6,42
18-20	3/4	1"1/16 12h UNF	1/2" BSP	S6152021	9,88
18-20	3/4	1"1/16 12h UNF	3/4" BSP	S6152026	9,88
25	1	1"5/16 12h UNF	1" BSP	S6152533	15,82

### Codo 90° macho JIC 37° - macho UNF orientable



Adaptateur orientable coude 90° mâle JIC 37° x mâle UNF + o'ring équipé  
90° Banjo elbow male JIC 37°-unf Banjo male  
Adattatore a 90° maschio-maschio orientabile JIC 37°-UNF

TUBO PIPE		ROSCA THREAD		REF. PART N°	€
6	1/4	7/16" 20h JIC	7/16" 20h UNF	S5750611	3,38
6	1/4	7/16" 20h JIC	1/2" 20h UNF	S5750612	8,40
8	5/16	1/2" 20h JIC	1/2" 20h UNF	S5750812	3,79
10	3/8	9/16" 18h JIC	9/16" 18h UNF	S5751014	4,86
10	3/8	9/16" 18h JIC	3/4" 16h UNF	S5751019	5,35
12	1/2	3/4" 16h JIC	7/8" 14h UNF	S5751222	13,45
14-15-16	5/8	7/8" 14h JIC	3/4" 16h UNF	S5751619	14,35
14-15-16	5/8	7/8" 14h JIC	7/8" 14h UNF	S5751622	9,05
18-20	3/4	1"1/16 12h JIC	7/8" 14h UNF	S5752022	17,06
18-20	3/4	1"1/16 12h JIC	1"1/16 12h UNF	S5752027	10,54
25	1	1"5/16 12h JIC	1"1/16 12h UNF	S5752527	29,29
25	1	1"5/16 12h JIC	1"5/16 12h UNF	S5752533	24,07
30-32	1 1/4	1"5/8 12h JIC	1"5/8 12h UNF	S5753241	47,72
38	1 1/2	1"7/8 12h JIC	1"7/8 12h UNF	S5753848	72,99

### Codo 90° macho JIC 37° - macho métrico orientable



Adaptateur orientable coude 90° mâle JIC 37° x mâle Métrique + o'ring équipé  
90° Elbow male JIC 37°-Metric Banjo male  
Adattatore a 90° maschio-maschio orientabile JIC 37° Metrico

TUBO PIPE		ROSCA THREAD		REFERENCIA PART N°	€
6	1/4	7/16" 20h UNF	M10x1	S6250610	3,29
8	5/16	1/2" 20h UNF	M12x1,5	S6250812	10,41
10	3/8	9/16" 18h UNF	M14x1,5	S6251014	4,45
12	1/2	3/4" 16h UNF	M16x1,5	S6251216	11,73
12	1/2	3/4" 16h UNF	M18x1,5	S6251218	5,93
14-15-16	5/8	7/8" 14h UNF	M18x1,5	S6251618	13,43
14-15-16	5/8	7/8" 14h UNF	M22x1,5	S6251622	8,31
18-20	3/4	1"1/16 12h UNF	M22x1,5	S6252022	11,85
18-20	3/4	1"1/16 12h UNF	M 27x2	S6252027	20,95
25	1	1"5/16 12h UNF	M33x2	S6252533	18,03

## Racores JIC 37°

Raccords JIC 37°  
JIC 37° fittings  
Raccordi JIC 37°

### Tes macho-macho-macho JIC 37°

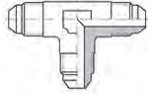

Tés égaux mâle JIC 37°

Union Tee male JIC 37°

Adattatore a T maschio JIC 37°

TUBO PIPE	ROSCA THREAD	REFERENCIA PART N°	€
6	1/4	7/16" 20h UNF	<b>S50506</b> 3,79
8	5/16	1/2" 20h UNF	<b>S50508</b> 3,87
10	3/8	9/16" 18h UNF	<b>S50510</b> 4,61
12	1/2	3/4" 16h UNF	<b>S50512</b> 7,00
14-15-16	5/8	7/8" 14h UNF	<b>S50516</b> 8,07
18-20	3/4	1"1/16 12h UNF	<b>S50520</b> 10,37
25	1	1"5/16 12h UNF	<b>S50525</b> 11,85
30-32	1 1/4	1"5/8 12h UNF	<b>S50532</b> 52,22
38	1 1/2	1"7/8 12h UNF	<b>S50538</b> 99,80

### Tes macho-hembra giratoria-macho JIC 37°



Tés égaux tournantes JIC 37° au centre

Swivel brunch Tee male JIC 37°-swivel nut JIC 37°-male JIC 37°

Adattatore a T maschio-femmina girevole-maschio JIC 37°

TUBO PIPE	ROSCA THREAD	REF. PART N°	€
6	1/4	7/16" 20h UNF	<b>S68506</b> 5,19
8	5/16	1/2" 20h UNF	<b>S68508</b> 4,94
10	3/8	9/16" 18h UNF	<b>S68510</b> 4,94
12	1/2	3/4" 16h UNF	<b>S68512</b> 7,90
14-15-16	5/8	7/8" 14h UNF	<b>S68516</b> 9,80
18-20	3/4	1"1/16 12h UNF	<b>S68520</b> 12,26
25	1	1"5/16 12h UNF	<b>S68525</b> 43,11
30-32	1 1/4	1"5/8 12h UNF	<b>S68532</b> 70,95
38	1 1/2	1"7/8 12h UNF	<b>S68538</b> 106,12

### Tes macho-macho-hembra giratoria JIC 37°

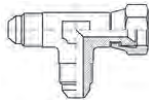

Tés égaux tournantes JIC 37° au latéral

Swivel run Tee male JIC 37°-swivel nut JIC 37°

Adattatore a T maschio-maschio-femmina girevole JIC 37°

TUBO PIPE	ROSCA THREAD	REF. PART N°	€
6	1/4	7/16" 20h UNF	<b>S68006</b> 5,19
8	5/16	1/2" 20h UNF	<b>S68008</b> 4,94
10	3/8	9/16" 18h UNF	<b>S68010</b> 4,94
12	1/2	3/4" 16h UNF	<b>S68012</b> 7,90
14-15-16	5/8	7/8" 14h UNF	<b>S68016</b> 9,80
18-20	3/4	1"1/16 12h UNF	<b>S68020</b> 12,26
25	1	1"5/16 12h UNF	<b>S68025</b> 22,62
30-32	1 1/4	1"5/8 12h UNF	<b>S68032</b> 72,35
38	1 1/2	1"7/8 12h UNF	<b>S68038</b> 108,05

### Te macho JIC 37° - macho orientable BSP central

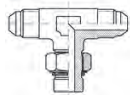

Té orientable mâle JIC 37° x mâle gaz cyl + o'ring x mâle JIC 37° équipé

Tee male JIC 37°-BSP central Banjo male-male JIC 37°

Raccordo a T JIC 37° orientabile centrale BSP (maschio-maschio orientabile-maschio)

TUBO PIPE	ROSCA THREAD	REF. PART N°	€
6	1/4	7/16" 20h UNF 1/4" BSP	<b>S6100613</b> 4,86
8	5/16	1/2" 20h UNF 1/4" BSP	<b>S6100813</b> 11,97
10	3/8	9/16" 18h UNF 1/4" BSP	<b>S6101013</b> 4,86
10	3/8	9/16" 18h UNF 3/8" BSP	<b>S6101017</b> 22,47
12	1/2	3/4" 16h UNF 3/8" BSP	<b>S6101217</b> 6,17
14-15-16	5/8	7/8" 14h UNF 1/2" BSP	<b>S6101621</b> 10,70
18-20	3/4	1"1/16 12h UNF 3/4" BSP	<b>S6102026</b> 29,18
25	1	1"5/16 12h UNF 1" BSP	<b>S6102533</b> 22,88
30-32	1 1/4	1"5/8 12h UNF 1"1/4 BSP	<b>S6103242</b> 74,73

### Te macho JIC 37° - macho orientable UNF central

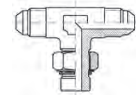

Té orientable mâle JIC 37° x mâle UNF + o'ring x mâle JIC 37° équipé

Tee male JIC 37°-central Banjo UNF-male JIC 37°

Raccordo a T JIC 37° orientabile centrale UNF (maschio-maschio orientabile-maschio)

TUBO PIPE	ROSCA THREAD	REFERENCIA PART N°	€
6	1/4	7/16" 20h UNF	<b>S5850611</b> 12,02
8	5/16	1/2" 20h UNF	<b>S5850812</b> 16,08
10	3/8	9/16" 18h UNF	<b>S5851014</b> 16,42
12	1/2	3/4" 16h UNF	<b>S5851219</b> 16,18
14-15-16	5/8	7/8" 14h UNF	<b>S5851622</b> 24,42
18-20	3/4	1"1/16 12h UNF	<b>S5852027</b> 32,23
25	1	1"5/16 12h UNF	<b>S5852533</b> 48,30

## Racores JIC 37°

Raccords JIC 37°

JIC 37° fittings

Raccordi JIC 37°

Pipe

DIN 2353 Pipe Fittings

Gas tube fittings

JIC 37° fittings

SAE Flanges

Clamps

Machines for  
processing rigid pipes

### Te macho JIC 37° - macho orientable métrico central

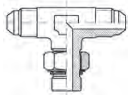

Té orientable mâle JIC 37° x mâle Métrique + o'ring x mâle JIC 37° équipé

Tee male JIC 37°-Metric central Banjo male-male JIC 37°

Raccordo a T JIC 37° orientabile centrale Metrico (maschio-maschio orientabile-maschio)

TUBO PIPE		ROSCA THREAD		REFERENCIA PART N°	€
6	1/4	7/16" JIC	M10X1	<b>S6350610</b>	<b>11,89</b>
8	5/16	1/2" JIC	M12X1.5	<b>S6350812</b>	<b>14,19</b>
10	3/8	9/16" JIC	M14X1.5	<b>S6351014</b>	<b>12,74</b>
12	1/2	3/4" JIC	M18x1.5	<b>S6351218</b>	<b>17,37</b>
14-15-16	5/8	7/8" JIC	M18X1.5	<b>S6351618</b>	<b>28,51</b>
14-15-16	5/8	7/8" JIC	M22X1.5	<b>S6351622</b>	<b>28,51</b>
18-20	3/4	1"1/16 JIC	M27X2	<b>S6352027</b>	<b>33,95</b>
25	1	1"5/16 JIC	M33X2	<b>S6352533</b>	<b>44,36</b>

### Te macho JIC 37° - macho orientable BSP lateral

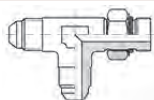

Té orientable mâle JIC 37° x mâle JIC 37° x mâle gaz cyl + o'ring équipé

Tee male JIC 37°-BSP lateral Banjo male-male JIC 37°

Raccordo a T JIC 37° orientabile laterale BSP (maschio-maschio-maschio orientabile)

TUBO PIPE		ROSCA THREAD		REF. PART N°	€
8	5/16	1/2" 20h UNF	1/4" BSP	<b>S6050813</b>	<b>4,45</b>
10	3/8	9/16" 18h UNF	1/4" BSP	<b>S6051013</b>	<b>7,30</b>
12	1/2	3/4" 16h UNF	3/8" BSP	<b>S6051217</b>	<b>6,09</b>
14-15-16	5/8	7/8" 14h UNF	1/2" BSP	<b>S6051621</b>	<b>8,73</b>
18-20	3/4	1"1/16 12h UNF	3/4" BSP	<b>S6052026</b>	<b>17,94</b>
25	1	1"5/16 12h UNF	1" BSP	<b>S6052533</b>	<b>43,91</b>
30-32	1 1/4	1"5/8 12h UNF	1"1/4 BSP	<b>S6053242</b>	<b>66,10</b>
38	1 1/2	1"7/8 12h UNF	1"1/2 BSP	<b>S6053848</b>	<b>90,65</b>

### Te macho JIC 37° - macho orientable UNF lateral



Té orientable mâle JIC 37° x mâle JIC 37°x mâle UNF + o'ring équipé

Tee male JIC 37°-lateral Banjo UNF-male JIC 37°

Raccordo a T JIC 37° orientabile laterale UNF (maschio-maschio-maschio orientabile)

TUBO PIPE		ROSCA THREAD		REFERENCIA PART N°	€
6	1/4	7/16" JIC	7/16" UNF	<b>S5800611</b>	<b>19,01</b>
8	5/16	1/2" JIC	1/2" UNF	<b>S5800812</b>	<b>19,01</b>
10	3/8	9/16" JIC	9/16" UNF	<b>S5801014</b>	<b>11,63</b>
16	5/8	7/8" JIC	7/8" UNF	<b>S5801622</b>	<b>22,91</b>
20	3/4	1"1/16 JIC	1"1/16 UNF	<b>S5802027</b>	<b>35,41</b>
25	1	1"5/16 JIC	1"5/16 UNF	<b>S5802533</b>	<b>52,70</b>

### Te macho JIC 37° - macho orientable métrico lateral

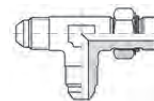

Té orientable mâle JIC 37° x mâle JIC 37°x mâle Métrique + o'ring équipé

Tee male JIC 37°-Metric lateral Banjo male-male JIC 37°

Raccordo a T JIC 37° orientabile laterale Metrico (maschio-maschio-maschio orientabile)

TUBO PIPE		ROSCA THREAD		REFERENCIA PART N°	€
10	3/8	9/16" 18h UNF	M14x1,5	<b>S6301014</b>	<b>12,74</b>
12	1/2	3/4" 16h UNF	M16x1,5	<b>S6301216</b>	<b>16,58</b>
12	1/2	3/4" 16h UNF	M18x1,5	<b>S6301218</b>	<b>22,32</b>
14-15-16	5/8	7/8" 14h UNF	M18x1,5	<b>S6301618</b>	<b>28,51</b>
14-15-16	5/8	7/8" 14h UNF	M22x1,5	<b>S6301622</b>	<b>28,51</b>
18-20	3/4	1"1/16 12h UNF	M27X1.5	<b>S6302027</b>	<b>33,95</b>
25	1	1"5/16 12h UNF	M33x2	<b>S6302533</b>	<b>53,92</b>



## Artículos bajo consulta

Articles à consulter | Items on request | Articoli su richiesta

### S160

**Racor macho NPT - hembra giratoria JIC 37°** | Adapteur femelle tournante JIC 37° x mâle NPT équipé | Adaptor swivel nut JIC-male NPT | Niples maschio-femmina NPT-JIC 37°

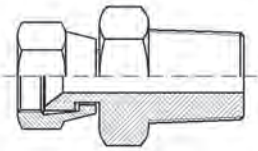

### S170

**Racor macho UNF - hembra giratoria JIC 37°** | Adapteur femelle tournante JIC 37° x mâle UNF équipé | Adaptor swivel nut JIC-male UNF | Niples maschio-femmina UNF-JIC 37°

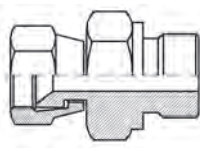

### S190

**Racor macho Métrico - hembra giratoria JIC 37°** | Adapteur femelle tournante JIC 37° x mâle Métrique équipé | Adaptor swivel nut JIC-male UNF | Niples maschio-femmina UNF-JIC 37°

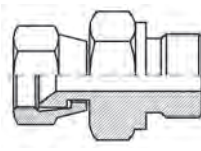

### S530

**Te macho JIC 37° - macho NPT lateral** | Té mâle JIC 37° x mâle JIC 37° x mâle NPT équipé | Tee male JIC 37°-male JIC 37°-lateral NPT male | Raccordo a T maschio JIC 37°-maschio JIC 37°-maschio laterale (NPT)



### S535

**Te macho JIC 37° - macho NPT central** | Té mâle JIC 37° x mâle NPT x mâle JIC 37° équipé | Tee male JIC 37°-NPT central male-male JIC 37° | Raccordo a T maschio JIC 37° - maschio centrale NPT-maschio JIC 37°

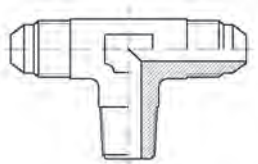

### S540

**Codo 45° macho JIC 37° - macho NPT** | Adapteur coude 45° mâle JIC 37° x mâle NPT équipé | 45° Elbow male JIC 37°-male NPT | Adattatore a 45° maschio JIC 37°-maschio NPT

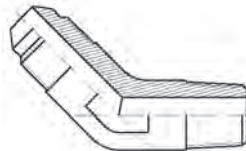

### S555

**Te macho JIC 37° - macho BSPT lateral** | Té mâle JIC 37° x mâle JIC 37° x mâle BSPT équipé | Tee male JIC 37°-male JIC 37°-lateral BSPT male | Raccordo a T maschio JIC 37°-maschio JIC 37°-maschio laterale BSPT

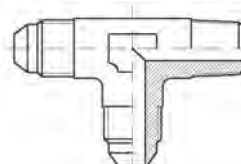

### S560

**Te macho JIC 37° - macho BSPT central** | Té mâle JIC 37° x mâle BSPT x mâle JIC 37° équipé | Tee male JIC 37°-BSPT central male-male JIC 37° | Raccordo a T maschio JIC 37° - maschio centrale BSPT-maschio JIC 37°

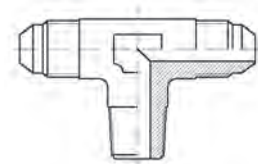

### S565

**Codo 45° macho JIC 37° - macho BSPT** | Adapteur coude 45° mâle JIC 37° x mâle BSPT équipé | 45° Elbow male JIC 37°-male BSPT | Adattatore a 45° maschio JIC 37°-maschio BSPT

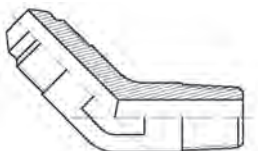

### S590

**Codo 45° macho JIC 37° - macho UNF orient.** | Adapteur coude 45° mâle JIC 37° x mâle UNF + o'ring et bae équipé | 45° Elbow male JIC 37°-UNF Banjo male | Adattatore a 45° maschio JIC 37°-maschio UNF orientabile

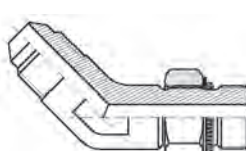

### S655

**Te macho JIC 37° pasatabiques lateral** | Té mâle JIC 37° x mâle JIC 37° x passe cloison mâle JIC 37° équipé | Tee male JIC 37°-male JIC 37°-lateral bulkhead male JIC 37° | Raccordo a T maschio JIC 37°-maschio JIC 37°-passaparete laterale maschio JIC 37°

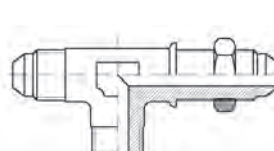

### S660

**Te macho JIC 37° pasatabiques central** | Té mâle JIC 37° x passe cloison mâle JIC 37° x mâle JIC 37° équipé | Tee male JIC 37°-central bulkhead male JIC 37°-male JIC 37° | Raccordo a T maschio JIC 37°-passaparete centrale maschio JIC 37°-maschio JIC 37°

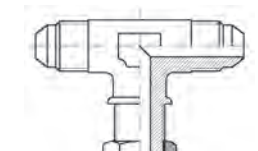

### S665

**Codo 45° pasatabiques macho - macho JIC 37°** | Coude 45° passe cloison mâle-mâle JIC 37° | 45° Bulkhead elbow male - male JIC 37° | Adattatore a 45° passaparete maschio - maschio JIC 37°

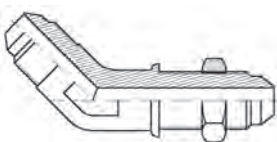

# Bridas SAE

Brides de fixation SAE

SAE Flanges

Flangia SAE



# Bridas SAE

Brides de fixation SAE | SAE Flangias | Flange SAE

Pipe

## ► **Bridas Roscadas** | Brides taraudées | Threaded flanges | Flangia filettate

207

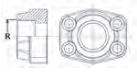

AFS...G

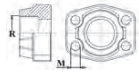

GFS...G

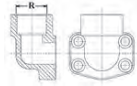

AFS...90G

DIN 2353 Pipe Fittings

## ► **Bridas soldables tubo gas** | Brides à souder pour tube gaz | Welding flanges for gas tube | Flangia a saldare per tubo gas

208

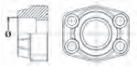

AFS...S

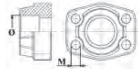

GFS...S

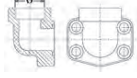

AFS...90S

Gas tube fittings

## ► **Bridas soldables tubo métrico** | Brides à souder pour tube métrique | Welding flanges for metric tube | Flangia a saldare per tubo Metrico

209

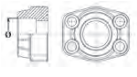

AFS...SA

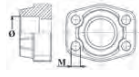

GFS...SA

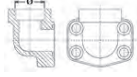

AFS...90SA

JIC 37° fittings

## ► **Bridas soldables macho** | Brides à souder mâle | Male welding flanges | Flangia a saldare maschio

210

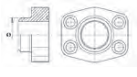

AFS...ST

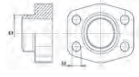

GFS...ST

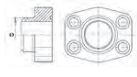

AFS...RE

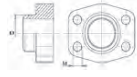

GFS...RE

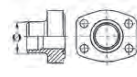

AFS...STRE

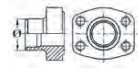

GFS...STRE

SAE Flanges

## ► **Bridas roscadas macho** | Brides taraudées mâle | Male threaded flanges | Flangia filettate maschio

212

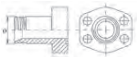

AFS...B



AFS...E

## ► **Bridas ciegas** | Brides avec obturateur fermé | Blind flanges | Flangia cieche

212

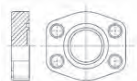

AFC



GFC

Clamps

## ► **Bridas para flexibles** | Brides SAE pour flexibles | SAE Flanges for hoses | Flangia SAE per tubi flessibili

213

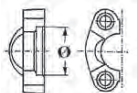

AFS...

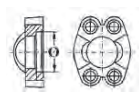

AFSl...

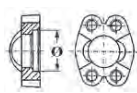

GFSl...

Machines for processing rigid pipes

► **Conos soldar** | Collets à souder | Welding adaptors for flanges | Ogive a saldare

214

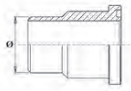

SFS...ST

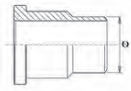

SFS...STC

► **Bridas Cetop** | Brides Cetop | Cetop flanges | Flangia Cetop

214

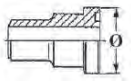

COD...ST

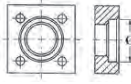

CET...ST



# Bridas SAE

Brides de fixation SAE  
SAE Flangias  
Flange SAE

## Brida roscada hembra BSP

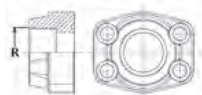

Bride taraudée femelle BSP  
BSP Female threaded flange  
Flangia filettata femmina BSP

SERIE	ROSCA THREAD	TAMAÑO SIZE	REFERENCIA PART N°	€
3000 PSI	1/2" BSP	1/2"	AFS080G	20,44
3000 PSI	3/8" BSP	1/2"	AFS080G038	20,44
3000 PSI	3/4" BSP	3/4"	AFS100G	21,31
3000 PSI	1/2" BSP	3/4"	AFS100G012	21,31
3000 PSI	1" BSP	1"	AFS102G	24,67
3000 PSI	3/4" BSP	1"	AFS102G034	25,84
3000 PSI	1"1/4 BSP	1"1/4"	AFS104G	29,62
3000 PSI	1" BSP	1"1/4"	AFS104G100	31,32
3000 PSI	1"1/2 BSP	1"1/2"	AFS106G	39,11
3000 PSI	1"1/4 BSP	1"1/2"	AFS106G114	39,11
3000 PSI	2" BSP	2"	AFS108G	45,74
3000 PSI	1"1/2 BSP	2"	AFS108G112	48,07
3000 PSI	2"1/2 BSP	2"1/2"	AFS110G	54,55
3000 PSI	2" BSP	2"1/2"	AFS110G200	58,87
3000 PSI	3" BSP	3"	AFS112G	65,98
3000 PSI	2"1/2 BSP	3"	AFS112G212	72,14
3000 PSI	3"1/2 BSP	3"1/2"	AFS114G	94,01
3000 PSI	3" BSP	3"1/2"	AFS114G300	102,65
3000 PSI	4" BSP	4"	AFS116G	101,80
3000 PSI	3"1/2 BSP	4"	AFS116G312	111,26
6000 PSI	1/2" BSP	1/2"	AFS401G012	22,20
6000 PSI	3/8" BSP	1/2"	AFS401G038	22,20
6000 PSI	1/2" BSP	3/4"	AFS402G012	26,36
6000 PSI	1" BSP	1"	AFS403G	30,48
6000 PSI	3/4" BSP	1"	AFS403G034	31,59
6000 PSI	1"1/4 BSP	1"1/4"	AFS404G	40,12
6000 PSI	1" BSP	1"1/4"	AFS404G100	40,12
6000 PSI	1"1/2 BSP	1"1/2"	AFS405G	60,27
6000 PSI	1"1/4 BSP	1"1/2"	AFS405G114	60,27
6000 PSI	2" BSP	2"	AFS406G	83,32
6000 PSI	1"1/2 BSP	2"	AFS406G112	87,37

## Contrabrida roscada hembra BSP

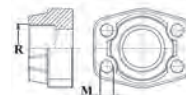

Contre-bride taraudée femelle BSP  
BSP Female threaded counter-flange  
Controflangia filettata femmina BSP

SERIE	ROSCA THREAD	TAMAÑO SIZE	REFERENCIA PART N°	€
3000 PSI	1/2" BSP	1/2"	GFS080G	21,20
3000 PSI	3/8" BSP	1/2"	GFS080G038	21,51
3000 PSI	3/4" BSP	3/4"	GFS100G	23,02
3000 PSI	1/2" BSP	3/4"	GFS100G012	26,00
3000 PSI	1" BSP	1"	GFS102G	24,67
3000 PSI	3/4" BSP	1"	GFS102G034	29,60
3000 PSI	1"1/4 BSP	1"1/4"	GFS104G	29,62
3000 PSI	1" BSP	1"1/4"	GFS104G100	34,97
3000 PSI	1"1/2 BSP	1"1/2"	GFS106G	36,83
3000 PSI	1"1/4 BSP	1"1/2"	GFS106G114	43,03
3000 PSI	2" BSP	2"	GFS108G	45,74
3000 PSI	1"1/2 BSP	2"	GFS108G112	50,13
3000 PSI	2"1/2 BSP	2"1/2"	GFS110G	54,55
3000 PSI	2" BSP	2"1/2"	GFS110G200	59,82
3000 PSI	3" BSP	3"	GFS112G	65,98
3000 PSI	2"1/2 BSP	3"	GFS112G212	72,14
3000 PSI	3"1/2 BSP	3"1/2"	GFS114G	94,01
3000 PSI	3" BSP	3"1/2"	GFS114G300	102,65
3000 PSI	4" BSP	4"	GFS116G	101,80
3000 PSI	3"1/2 BSP	4"	GFS116G312	111,26
6000 PSI	1/2" BSP	1/2"	GFS401G012	21,34
6000 PSI	3/8" BSP	1/2"	GFS401G038	24,23
6000 PSI	3/4" BSP	3/4"	GFS402G	26,92
6000 PSI	1/2" BSP	3/4"	GFS402G012	29,60
6000 PSI	1" BSP	1"	GFS403G	30,48
6000 PSI	3/4" BSP	1"	GFS403G034	35,85
6000 PSI	1"1/4 BSP	1"1/4"	GFS404G	42,26
6000 PSI	1" BSP	1"1/4"	GFS404G100	50,13
6000 PSI	1"1/2 BSP	1"1/2"	GFS405G	65,98
6000 PSI	1"1/4 BSP	1"1/2"	GFS405G114	72,14
6000 PSI	2" BSP	2"	GFS406G	85,40
6000 PSI	1"1/2 BSP	2"	GFS406G112	94,89

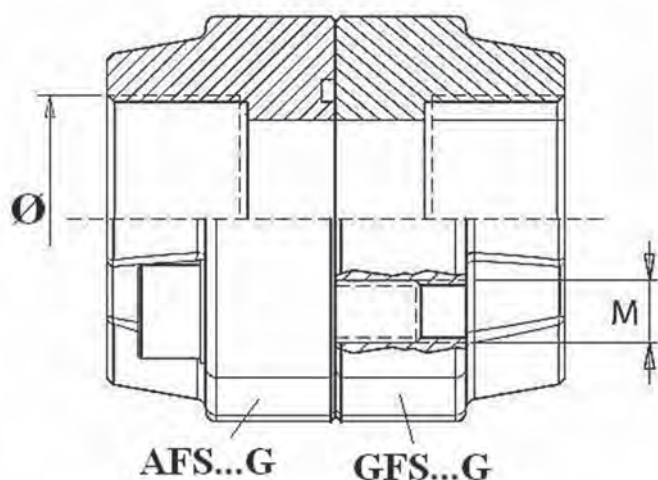

## Brida codo 90° roscada hembra BSP

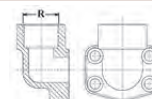

Bride 90° taraudée femelle BSP  
90° BSP female threaded flange  
Flangia a 90° filettata femmina BSP

SERIE	ROSCA THREAD	TAMAÑO SIZE	REFERENCIA PART N°	€
3000 PSI	1/2" BSP	1/2"	AFS08090G	39,92
3000 PSI	3/8" BSP	1/2"	AFS08090G038	48,40
3000 PSI	3/4" BSP	3/4"	AFS10090G	45,89
3000 PSI	1" BSP	1"	AFS10290G	50,07
3000 PSI	1"1/4 BSP	1"1/4"	AFS10490G	58,43
3000 PSI	1"1/2 BSP	1"1/2"	AFS10690G	83,56
3000 PSI	2" BSP	2"	AFS10890G	101,15
6000 PSI	1/2" BSP	1/2"	AFS40190G012	50,60
6000 PSI	3/8" BSP	1/2"	AFS40190G038	53,14
6000 PSI	3/4" BSP	3/4"	AFS40290G	50,35
6000 PSI	1" BSP	1"	AFS40390G	57,87
6000 PSI	1"1/4 BSP	1"1/4"	AFS40490G	81,92
6000 PSI	1"1/2 BSP	1"1/2"	AFS40590G	100,16

# Bridas SAE

Brides de fixation SAE  
SAE Flangias  
Flange SAE

Pipe

DIN 2353 Pipe Fittings

Gas tube fittings

JIC 37° fittings

SAE Flanges

Clamps

Machines for processing rigid pipes

## Brida soldable hembra tubo gas

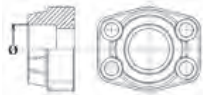

Bride à souder femelle tube gaz  
Welding female flange for gas tube  
Flangia femmina a saldare per tubo gas

SERIE	Ø in	TAMAÑO SIZE	REFERENCIA PART N°	€
3000 PSI	21.6	1/2"	<b>AFS080S</b>	<b>18,49</b>
3000 PSI	17.5	1/2"	<b>AFS080S038</b>	<b>20,63</b>
3000 PSI	27.2	3/4"	<b>AFS100S</b>	<b>21,51</b>
3000 PSI	34	1"	<b>AFS102S</b>	<b>22,99</b>
3000 PSI	42.8	1 1/4"	<b>AFS104S</b>	<b>27,00</b>
3000 PSI	48.6	1 1/2"	<b>AFS106S</b>	<b>36,40</b>
3000 PSI	61	2"	<b>AFS108S</b>	<b>43,98</b>
3000 PSI	76.6	2 1/2"	<b>AFS110S</b>	<b>51,90</b>
3000 PSI	90.5	3"	<b>AFS112S</b>	<b>62,44</b>
3000 PSI	103	3 1/2"	<b>AFS114S</b>	<b>88,84</b>
3000 PSI	115.5	4"	<b>AFS116S</b>	<b>94,89</b>
6000 PSI	21.6	1/2"	<b>AFS401S012</b>	<b>22,66</b>
6000 PSI	17.5	1/2"	<b>AFS401S038</b>	<b>23,31</b>
6000 PSI	27.2	3/4"	<b>AFS402S</b>	<b>25,11</b>
6000 PSI	34	1"	<b>AFS403S</b>	<b>29,60</b>
6000 PSI	42.8	1 1/4"	<b>AFS404S</b>	<b>41,15</b>
6000 PSI	48.6	1 1/2"	<b>AFS405S</b>	<b>61,56</b>
6000 PSI	61	2"	<b>AFS406S</b>	<b>81,07</b>

## Contrabrida soldable hembra tubo gas

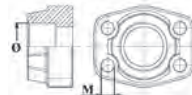

Contre-bride à souder femelle tube gaz  
Welding female counter-flange for gas tube  
Controflangia femmina a saldare per tubo gas

SERIE	Ø in	TAMAÑO SIZE	REFERENCIA PART N°	€
3000 PSI	21.6	1/2"	<b>GFS080S</b>	<b>18,52</b>
3000 PSI	17.5	1/2"	<b>GFS080S038</b>	<b>20,63</b>
3000 PSI	27.2	3/4"	<b>GFS100S</b>	<b>21,51</b>
3000 PSI	34	1"	<b>GFS102S</b>	<b>23,82</b>
3000 PSI	42.8	1 1/4"	<b>GFS104S</b>	<b>28,35</b>
3000 PSI	48.6	1 1/2"	<b>GFS106S</b>	<b>36,39</b>
3000 PSI	61	2"	<b>GFS108S</b>	<b>43,98</b>
3000 PSI	76.6	2 1/2"	<b>GFS110S</b>	<b>51,90</b>
3000 PSI	90.5	3"	<b>GFS112S</b>	<b>62,44</b>
3000 PSI	103	3 1/2"	<b>GFS114S</b>	<b>88,84</b>
3000 PSI	115.5	4"	<b>GFS116S</b>	<b>94,89</b>
6000 PSI	21.6	1/2"	<b>GFS401S012</b>	<b>22,63</b>
6000 PSI	27.2	3/4"	<b>GFS402S</b>	<b>25,11</b>
6000 PSI	34	1"	<b>GFS403S</b>	<b>29,60</b>
6000 PSI	42.8	1 1/4"	<b>GFS404S</b>	<b>41,28</b>
6000 PSI	48.6	1 1/2"	<b>GFS405S</b>	<b>61,56</b>
6000 PSI	61	2"	<b>GFS406S</b>	<b>81,07</b>

## Brida codo 90° soldable hembra tubo gas

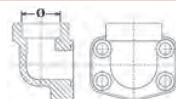

Bride 90° à souder femelle tube gaz  
90° welding female flange for gas tube  
Flangia a 90° femmina a saldare per tubo gas

SERIE	Ø in	TAMAÑO SIZE	REFERENCIA PART N°	€
3000 PSI	21.6	1/2"	<b>AFS08090S</b>	<b>44,12</b>
3000 PSI	17.5	1/2"	<b>AFS08090S038</b>	<b>44,86</b>
3000 PSI	27.2	3/4"	<b>AFS10090S</b>	<b>47,81</b>
3000 PSI	34	1"	<b>AFS10290S</b>	<b>53,67</b>
3000 PSI	42.8	1 1/4"	<b>AFS10490S</b>	<b>62,44</b>
3000 PSI	48.6	1 1/2"	<b>AFS10690S</b>	<b>74,25</b>
3000 PSI	61	2"	<b>AFS10890S</b>	<b>93,22</b>
6000 PSI	21.6	1/2"	<b>AFS40190S012</b>	<b>48,40</b>
6000 PSI	17.5	1/2"	<b>AFS40190S038</b>	<b>48,40</b>
6000 PSI	27.2	3/4"	<b>AFS40290S</b>	<b>53,67</b>
6000 PSI	34	1"	<b>AFS40390S</b>	<b>60,24</b>
6000 PSI	42.8	1 1/4"	<b>AFS40490S</b>	<b>76,52</b>
6000 PSI	48.6	1 1/2"	<b>AFS40590S</b>	<b>93,22</b>

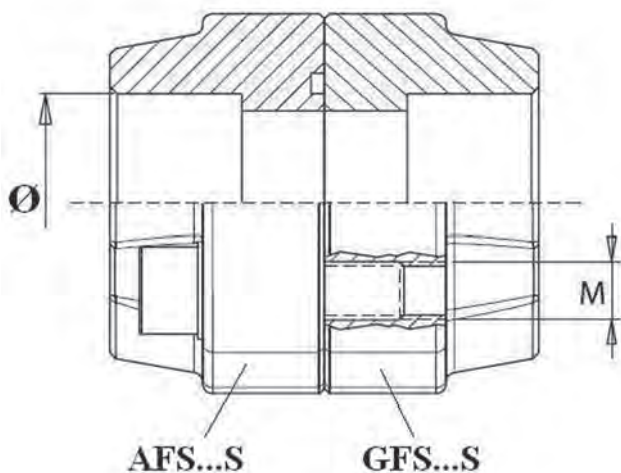



## Bridas SAE

Brides de fixation SAE  
SAE Flangias  
Flange SAE

### Brida soldable hembra tubo métrico



Bride à souder femelle tube métrique  
Female welding flange for metric tube  
Flangia femmina a saldare per tubo Metrico

SERIE	Ø in	TAMAÑO SIZE	REFERENCIA PART N°	€
3000 PSI	20.3	1/2"	AFS080SA20	20,63
3000 PSI	25.3	3/4"	AFS100SA25	21,51
3000 PSI	30.3	1"	AFS102SA30	25,11
3000 PSI	38.3	1"1/4	AFS104SA38	28,68
3000 PSI	50.5	1"1/2	AFS106SA50	36,77
6000 PSI	20.3	1/2"	AFS401SA20	23,31
6000 PSI	25.3	3/4"	AFS402SA25	25,11
6000 PSI	30.3	1"	AFS403SA30	29,60
6000 PSI	38.3	1"1/4	AFS404SA38	41,36
6000 PSI	50.5	1"1/2	AFS405SA50	61,56

### Brida codo 90° soldable hembra tubo métrico

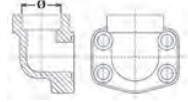

Bride 90° à souder femelle tube métrique  
90° female welding flange for metric tube  
Flangia a 90° femmina a saldare per tubo Metrico

SERIE	Ø in	TAMAÑO SIZE	REFERENCIA PART N°	€
3000 PSI	20.3	1/2"	AFS08090SA20	44,86
3000 PSI	25.3	3/4"	AFS10090SA25	48,40
3000 PSI	30.3	1"	AFS10290SA30	53,67
3000 PSI	38.3	1"1/4	AFS10490SA38	62,44
3000 PSI	50.5	1"1/2	AFS10690SA50	76,52
6000 PSI	20.3	1/2"	AFS40190SA20	48,40
6000 PSI	25.3	3/4"	AFS40290SA25	53,67
6000 PSI	30.3	1"	AFS40390SA30	62,44
6000 PSI	38.3	1"1/4	AFS40490SA38	76,52
6000 PSI	50.3	1"1/2	AFS40590SA50	93,22

### Contrabrida soldable hembra tubo métrico

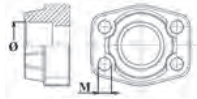

Contre-bride à souder femelle tube métrique  
Female welding counter-flange for metric tube  
Controflangia femmina a saldare per tubo Metrico

SERIE	Ø in	TAMAÑO SIZE	REFERENCIA PART N°	€
3000 PSI	20.3	1/2"	GFS080SA20	20,63
3000 PSI	25.3	3/4"	GFS100SA25	21,51
3000 PSI	30.3	1"	GFS102SA30	25,11
3000 PSI	38.3	1"1/4	GFS104SA38	28,68
6000 PSI	20.3	1/2"	GFS401SA20	23,31
6000 PSI	25.3	3/4"	GFS402SA25	25,08
6000 PSI	30.3	1"	GFS403SA30	29,60
6000 PSI	38.3	1"1/4	GFS404SA38	41,36
6000 PSI	50.5	1"1/2	GFS405SA50	61,56

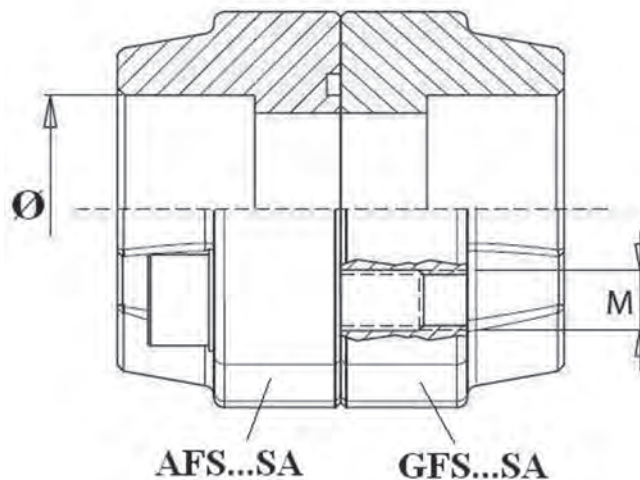

## Bridas SAE

Brides de fixation SAE  
SAE Flangias  
Flange SAE

Pipe

DIN 2353 Pipe Fittings

Gas tube fittings

JIC 37° fittings

SAE Flanges

Clamps

Machines for  
processing rigid pipes

## Brida soldable macho tubo gas

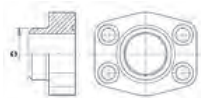

Bride à souder mâle tube gaz  
Male welding flange for gas tube  
Flangia a saldare maschio tubo gas

SERIE	Ø ext	TAMAÑO SIZE	REFERENCIA PART N°	€
3000 PSI	21.5	1/2"	AFS080ST	20,63
3000 PSI	17.5	1/2"	AFS080ST038	20,63
3000 PSI	28	3/4"	AFS100ST	21,51
3000 PSI	34	1"	AFS102ST	25,11
3000 PSI	42.8	1 1/4"	AFS104ST	28,68
3000 PSI	48.6	1 1/2"	AFS106ST	36,77
3000 PSI	61	2"	AFS108ST	43,98
3000 PSI	77	2 1/2"	AFS110ST	51,90
3000 PSI	92	3"	AFS112ST	62,44
3000 PSI	103	3 1/2"	AFS114ST	88,84
6000 PSI	21.5	1/2"	AFS401ST012	23,31
6000 PSI	17.5	1/2"	AFS401ST038	23,31
6000 PSI	28	3/4"	AFS402ST	25,11
6000 PSI	34	1"	AFS403ST	29,60
6000 PSI	42.8	1 1/4"	AFS404ST	41,36
6000 PSI	48.6	1 1/2"	AFS405ST	61,56
6000 PSI	61	2"	AFS406ST	81,07

## Brida soldable macho tubo métrico

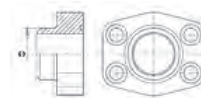

Bride à souder mâle tube métrique  
Male welding flange for metric tube  
Flangia a saldare maschio tubo Metrico

SERIE	Ø ext	TAMAÑO SIZE	REFERENCIA PART N°	€
3000 PSI	25	3/4"	AFS100SRE25	21,51
3000 PSI	30	1"	AFS102SRE30	25,11
3000 PSI	38	1 1/4"	AFS104SRE38	28,68
3000 PSI	42	1 1/2"	AFS106SRE42	36,77
3000 PSI	61	2"	AFS108SRE60	43,98
3000 PSI	49	2"	AFS108STRE48	43,98
3000 PSI	77	3"	AFS112SRE76	62,44
3000 PSI	77	3"	AFS112STRE76	62,44
3000 PSI	77	3 1/2"	AFS114STRE76	88,84
3000 PSI	90	3 1/2"	AFS114STRE88	88,84
3000 PSI	77	4"	AFS116STRE76	94,89
3000 PSI	90	4"	AFS116STRE88	94,89
6000 PSI	20	1/2"	AFS401SRE20	23,31
6000 PSI	20	3/4"	AFS402SRE20	25,11
6000 PSI	25	3/4"	AFS402SRE25	25,11
6000 PSI	25	1"	AFS403SRE25	29,60
6000 PSI	30	1"	AFS403SRE30	29,60
6000 PSI	38	1 1/4"	AFS404SRE38	41,36
6000 PSI	38	1 1/2"	AFS405SRE38	61,56
6000 PSI	61	2"	AFS406SRE60	81,07

## Contrabrida soldable macho tubo gas

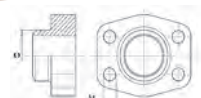

Contre-bride à souder mâle tube gaz  
Male welding counter-flange for gas tube  
Controfrangia a saldare maschio tubo gas

SERIE	Ø ext	TAMAÑO SIZE	REFERENCIA PART N°	€
3000 PSI	21.5	1/2"	GFS080ST	20,63
3000 PSI	17.5	1/2"	GFS080ST038	20,63
3000 PSI	28	3/4"	GFS100ST	21,51
3000 PSI	34	1"	GFS102ST	25,11
3000 PSI	42.8	1 1/4"	GFS104ST	28,68
3000 PSI	48.6	1 1/2"	GFS106ST	36,77
3000 PSI	61	2"	GFS108ST	43,98
3000 PSI	77	2 1/2"	GFS110ST	51,89
3000 PSI	92	3"	GFS112ST	62,44
3000 PSI	103	3 1/2"	GFS114ST	88,84
3000 PSI	115.5	4"	GFS116ST	94,89
6000 PSI	21.5	1/2"	GFS401ST012	23,31
6000 PSI	17.5	1/2"	GFS401ST038	23,31
6000 PSI	28	3/4"	GFS402ST	25,11
6000 PSI	34	1"	GFS403ST	29,60
6000 PSI	42.8	1 1/4"	GFS404ST	41,36
6000 PSI	48.6	1 1/2"	GFS405ST	61,56
6000 PSI	61	2"	GFS406ST	81,07

## Contrabrida soldable macho tubo métrico

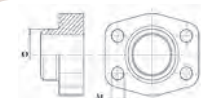

Contre-bride à souder mâle tube métrique  
Male welding counter-flange for metric tube  
Controfrangia a saldare maschio tubo Metrico

SERIE	Ø ext	TAMAÑO SIZE	REFERENCIA PART N°	€
3000 PSI	25	3/4"	GFS100SRE25	21,51
3000 PSI	30	1"	GFS102SRE30	25,11
3000 PSI	38	1 1/4"	GFS104SRE38	28,68
3000 PSI	42	1 1/2"	GFS106SRE42	36,77
3000 PSI	49	1 1/2"	GFS106SRE48	36,77
3000 PSI	61	2"	GFS108SRE60	43,98
3000 PSI	49	2"	GFS108STRE48	43,98
3000 PSI	77	2 1/2"	GFS110SRE76	51,90
3000 PSI	77	3"	GFS112SRE76	62,44
3000 PSI	77	3"	GFS112STRE76	62,44
3000 PSI	77	3 1/2"	GFS114STRE76	88,84
3000 PSI	90	3 1/2"	GFS114STRE88	88,84
3000 PSI	90	4"	GFS116STRE88	94,89
6000 PSI	20	1/2"	GFS401SRE20	23,31
6000 PSI	20	3/4"	GFS402SRE20	25,11
6000 PSI	25	3/4"	GFS402SRE25	25,11
6000 PSI	25	1"	GFS403SRE25	29,60
6000 PSI	30	1"	GFS403SRE30	29,60
6000 PSI	38	1 1/4"	GFS404SRE38	41,36
6000 PSI	38	1 1/2"	GFS405SRE38	61,56
6000 PSI	61	2"	GFS406SRE60	81,07

## Bridas SAE

Bridas de fixation SAE  
SAE Flangias  
Flange SAE

### Brida soldable macho serie L tubo métrico

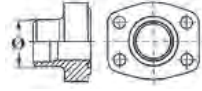

Bride à souder mâle série L tube métrique  
Male welding flange L serie for metric tube  
Flangia a saldare maschio serie L tubo Metrico

SERIE	Ø ext	TAMAÑO SIZE	REFERENCIA PART N°	€
3000 PSI	20	1/2"	<b>AFS080SRE20</b>	<b>20,63</b>
3000 PSI	22	1/2"	<b>AFS080SRE22</b>	<b>20,63</b>
3000 PSI	28	3/4"	<b>AFS100SRE28</b>	<b>21,51</b>
3000 PSI	35	1"	<b>AFS102SRE35</b>	<b>25,11</b>
3000 PSI	43	1"1/4	<b>AFS104SRE42</b>	<b>28,68</b>
3000 PSI	49	1"1/2	<b>AFS106STRE48</b>	<b>36,77</b>
3000 PSI	61	2"	<b>AFS108STRE60</b>	<b>43,98</b>
3000 PSI	77	2" 1/2	<b>AFS110STRE76</b>	<b>51,90</b>
3000 PSI	90	3"	<b>AFS112STRE88</b>	<b>62,44</b>
3000 PSI	115	4"	<b>AFS116STRE114</b>	<b>94,89</b>

### Contrabrida soldable macho serie L tubo métrico

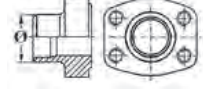

Contre-bride à souder mâle série L tube métrique  
Male welding counter-flange L serie for metric tube  
Controflangia a saldare maschio serial L tubo Metrico

SERIE	Ø ext	TAMAÑO SIZE	REFERENCIA PART N°	€
3000 PSI	20	1/2"	<b>GFS080SRE20</b>	<b>20,63</b>
3000 PSI	22	1/2"	<b>GFS080SRE22</b>	<b>20,63</b>
3000 PSI	28	3/4"	<b>GFS100SRE28</b>	<b>21,51</b>
3000 PSI	35	1"	<b>GFS102SRE35</b>	<b>25,11</b>
3000 PSI	43	1"1/4	<b>GFS104SRE42</b>	<b>28,68</b>
3000 PSI	49	1"1/2	<b>GFS106STRE48</b>	<b>36,77</b>
3000 PSI	61	2"	<b>GFS108STRE60</b>	<b>43,98</b>
3000 SPI	77	2" 1/2	<b>GFS110STRE76</b>	<b>51,90</b>
3000 PSI	90	3"	<b>GFS112STRE88</b>	<b>62,44</b>
3000 PSI	115	4"	<b>GFS116STRE114</b>	<b>94,89</b>

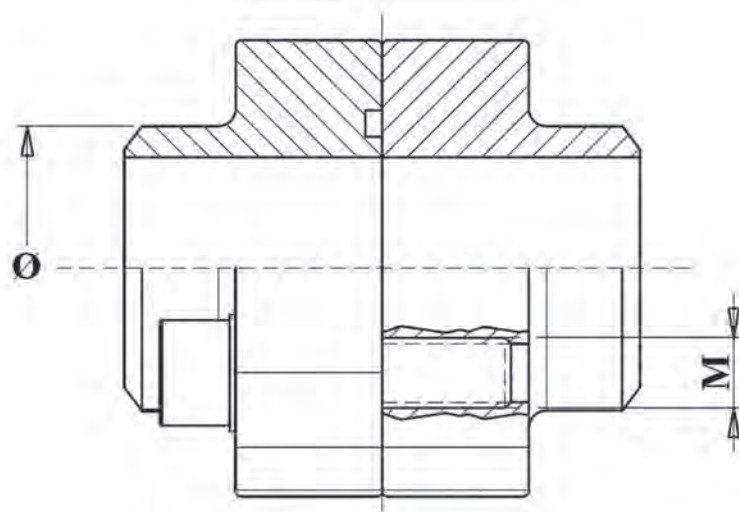

## Bridas SAE

Brides de fixation SAE  
SAE Flangias  
Flange SAE

Pipe

DIN 2353 Pipe Fittings

Gas tube fittings

JIC 37° fittings

SAE Flanges

Clamps

Machines for  
processing rigid pipes

## Brida roscada macho BSP

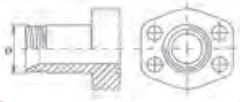

Brides taraudées mâle BSP  
BSP Male threaded flange  
Flangia maschio filettata BSP

SERIE	ROSCA THREAD	TAMAÑO SIZE	REFERENCIA PART N°	€
3000 PSI	1/2" BSP	1/2"	AFS080B	30,49
3000 PSI	3/8" BSP	1/2"	AFS080B038	34,97
3000 PSI	3/4" BSP	3/4"	AFS100B	38,58
3000 PSI	1/2" BSP	3/4"	AFS100B012	38,57
3000 PSI	1" BSP	1"	AFS102B	41,26
3000 PSI	3/4" BSP	1"	AFS102B034	45,71
3000 PSI	1"1/4 BSP	1"1/4"	AFS104B	49,31
3000 PSI	1" BSP	1"1/4"	AFS104B100	54,68
3000 PSI	1"1/2 BSP	1"1/2"	AFS106B	59,17
3000 PSI	1"1/4 BSP	1"1/2"	AFS106B114	66,34
6000 PSI	1/2" BSP	1/2"	AFS401B	33,17
6000 PSI	3/8" BSP	1/2"	AFS401B038	35,85
6000 PSI	3/4" BSP	3/4"	AFS402B	40,34
6000 PSI	1/2" BSP	3/4"	AFS402B012	43,94
6000 PSI	1" BSP	1"	AFS403B	49,31
6000 PSI	3/4" BSP	1"	AFS403B034	53,80
6000 PSI	1"1/4 BSP	1"1/4"	AFS404B	58,06
6000 PSI	1" BSP	1"1/4"	AFS404B100	65,10
6000 PSI	1"1/2 BSP	1"1/2"	AFS405B	68,60
6000 PSI	1"1/4 BSP	1"1/2"	AFS405B114	75,64

## Brida roscada macho métrico

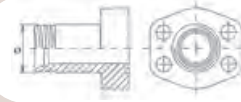

Brides taraudées mâle Métrique  
Metric Male threaded flange  
Flangia maschio filettata Metrica

SERIE	ROSCA THREAD	TAMAÑO SIZE	REFERENCIA PART N°	€
3000 PSI	M22x1,5	1/2"	AFS080E	30,49
3000 PSI	M30x2	3/4"	AFS100E	34,97
3000 PSI	M36x2	1"	AFS102E	41,26
3000 PSI	M45x2	1"1/4"	AFS104E	49,31
3000 PSI	M52x2	1"1/2"	AFS106E	59,17
6000 PSI	M24x1,5	1/2"	AFS401E	33,17
6000 PSI	M36X2	3/4"	AFS402E	40,34
6000 PSI	M42x2	1"	AFS403E	49,31
6000 PSI	M52x2	1"1/4"	AFS404E	58,06
6000 PSI	M52x2	1"1/2"	AFS405E	68,60

## Bridas ciegas

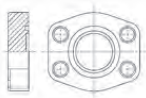

Brides avec obturateur fermé  
Blind flanges  
Flangia cieche

SERIE	TAMAÑO SIZE	REFERENCIA PART N°	€
3000 PSI	1/2"	AFC080	15,26
3000 PSI	3/4"	AFC100	15,88
3000 PSI	1"	AFC102	15,94
3000 PSI	1"1/4"	AFC104	19,33
3000 PSI	1"1/2"	AFC106	22,85
3000 PSI	2"	AFC108	23,77
3000 PSI	2"1/2"	AFC110	27,28
3000 PSI	3"	AFC112	43,09
3000 PSI	3"1/2"	AFC114	50,92
3000 PSI	4"	AFC116	54,36
3000 PSI	5"	AFC118	115,59
6000 PSI	1/2"	AFC401	17,94
6000 PSI	3/4"	AFC402	18,83
6000 PSI	1"	AFC403	21,51
6000 PSI	1"1/4"	AFC404	25,51
6000 PSI	1"1/2"	AFC405	29,93
6000 PSI	2"	AFC406	47,45

## Contrabridas ciegas

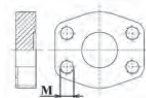

Contre-brides avec obturateur fermé  
Blind counter-flanges  
Controflangia cieche

SERIE	TAMAÑO SIZE	REFERENCIA PART N°	€
3000 PSI	1/2"	GFC080	15,26
3000 PSI	3/4"	GFC100	16,14
3000 PSI	1"	GFC102	18,83
3000 PSI	1"1/4"	GFC104	19,74
3000 PSI	1"1/2"	GFC106	23,31
3000 PSI	2"	GFC108	23,77
3000 PSI	2"1/2"	GFC110	27,28
3000 PSI	3"	GFC112	43,09
3000 PSI	3"1/2"	GFC114	50,92
3000 PSI	4"	GFC116	54,36
3000 PSI	5"	GFC118	115,59
6000 PSI	1/2"	GFC401	17,94
6000 PSI	3/4"	GFC402	18,83
6000 PSI	1"	GFC403	21,51
6000 PSI	1"1/4"	GFC404	25,51
6000 PSI	1"1/2"	GFC405	29,93
6000 PSI	2"	GFC406	47,45

# Bridas SAE

Brides de fixation SAE  
SAE Flangias  
Flange SAE

## Brida partida pasante

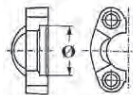

Demi-bride passage total  
SAE Split flange  
Semiflangia SAE

SERIE	TAMAÑO SIZE	REFERENCIA PART N°	€
3000 PSI	1/2"	<b>AFS301</b>	*
3000 PSI	3/4"	<b>AFS302</b>	*
3000 PSI	1"	<b>AFS303</b>	*
3000 PSI	1"1/4	<b>AFS304</b>	*
3000 PSI	1"1/2	<b>AFS305</b>	*
3000 PSI	2"	<b>AFS306</b>	*
3000 PSI	2"1/2	<b>AFS307</b>	*
3000 PSI	3"	<b>AFS308</b>	*
3000 PSI	3"1/2	<b>AFS309</b>	*
3000 PSI	4"	<b>AFS310</b>	*
3000 PSI	5"	<b>AFS311</b>	*
6000 PSI	1/2"	<b>AFS601</b>	*
6000 PSI	3/4"	<b>AFS602</b>	*
6000 PSI	1"	<b>AFS603</b>	*
6000 PSI	1"1/4	<b>AFS604</b>	*
6000 PSI	1"1/2	<b>AFS605</b>	*
6000 PSI	2"	<b>AFS606</b>	*

Ver precios en p.52 (Conexiones Standard CrIII) // Prix à la p.52 (Emboutis Série Standard CrIII) // See prices in p.52 (Standard Serie Fittings CrIII) // Vedere prezzi p.52 (Raccordi Serie Standard CrIII)

## Brida entera pasante

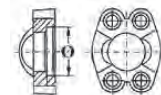

Bride monobloc passage total  
SAE Flange  
Flangia monoblocco SAE

SERIE	TAMAÑO SIZE	REFERENCIA PART N°	€
3000 PSI	1/2"	<b>AFSI301</b>	*
3000 PSI	3/4"	<b>AFSI302</b>	*
3000 PSI	1"	<b>AFSI303</b>	*
3000 PSI	1"1/4	<b>AFSI304</b>	*
3000 PSI	1"1/2	<b>AFSI305</b>	*
3000 PSI	2"	<b>AFSI306</b>	*
3000 PSI	2"1/2	<b>AFSI307</b>	*
3000 PSI	3"	<b>AFSI308</b>	*
3000 PSI	3"1/2	<b>AFSI309</b>	*
3000 PSI	4"	<b>AFSI310</b>	*
3000 PSI	5"	<b>AFSI311</b>	*
6000 PSI	1/2"	<b>AFSI601</b>	*
6000 PSI	3/4"	<b>AFSI602</b>	*
6000 PSI	1"	<b>AFSI603</b>	*
6000 PSI	1"1/4	<b>AFSI604</b>	*
6000 PSI	1"1/2	<b>AFSI605</b>	*
6000 PSI	2"	<b>AFSI606</b>	*

Ver precios en p.52 (Conexiones Standard CrIII) // Prix à la p.52 (Emboutis Série Standard CrIII) // See prices in p.52 (Standard Serie Fittings CrIII) // Vedere prezzi p.52 (Raccordi Serie Standard CrIII)

## Contrabrida rosca Métrica

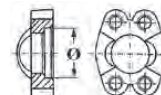

Contre-bride métrique  
Metric threaded counter-flange  
Controflangia filettata Metrica

SERIE	TAMAÑO SIZE	REFERENCIA PART N°	€
3000 PSI	1/2"	<b>GFSI301</b>	<b>12,21</b>
3000 PSI	3/4"	<b>GFSI302</b>	<b>13,10</b>
3000 PSI	1"	<b>GFSI303</b>	<b>15,06</b>
3000 PSI	1"1/4	<b>GFSI304</b>	<b>17,75</b>
3000 PSI	1"1/2	<b>GFSI305</b>	<b>20,63</b>
3000 PSI	2"	<b>GFSI306</b>	<b>37,66</b>
3000 PSI	2"1/2	<b>GFSI307</b>	<b>49,44</b>
3000 PSI	3"	<b>GFSI308</b>	<b>71,42</b>
3000 PSI	3"1/2	<b>GFSI309</b>	<b>105,93</b>
3000 PSI	4"	<b>GFSI310</b>	<b>132,84</b>
3000 PSI	5"	<b>GFSI311</b>	<b>161,46</b>
6000 PSI	1/2"	<b>GFSI601</b>	<b>14,01</b>
6000 PSI	3/4"	<b>GFSI602</b>	<b>15,06</b>
6000 PSI	1"	<b>GFSI603</b>	<b>19,74</b>
6000 PSI	1"1/4	<b>GFSI604</b>	<b>28,52</b>
6000 PSI	1"1/2	<b>GFSI605</b>	<b>57,70</b>
6000 PSI	2"	<b>GFSI606</b>	<b>80,75</b>

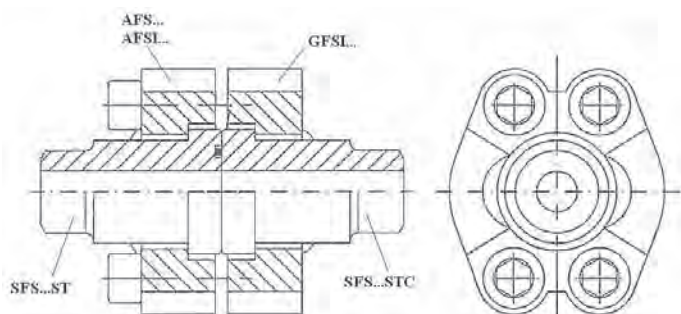

## Bridas SAE

Brides de fixation SAE  
SAE Flangias  
Flange SAE

Pipe

DIN 2353 Pipe Fittings

Gas tube fittings

JIC 37° fittings

SAE Flanges

Clamps

Machines for  
processing rigid pipes

## Cono soldable tubo métrico

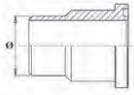

Collet à souder tube métrique  
Welding adaptor for metric tube  
Adattatore a saldare per tubo Metrico

SERIE	Ø ext	TAMAÑO SIZE	REFERENCIA PART N°	€
3000 PSI	16	1/2"	SFS301ST	14,96
3000 PSI	25	3/4"	SFS302ST	16,73
3000 PSI	30	1"	SFS303ST	17,62
3000 PSI	38	1"1/4	SFS304ST	22,89
3000 PSI	45	1"1/2	SFS305ST	29,04
3000 PSI	60	2"	SFS306ST	37,82
3000 PSI	70	2"1/2	SFS307ST	50,13
3000 PSI	80	3"	SFS308ST	67,72
3000 PSI	100	3"1/2	SFS309ST	115,23
3000 PSI	114.3	4"	SFS310ST	129,27
3000 PSI	139.7	5"	SFS311ST	159,17
6000 PSI	16	1/2"	SFS601ST	15,85
6000 PSI	25	3/4"	SFS602ST	18,19
6000 PSI	30	1"	SFS603ST	20,18
6000 PSI	38	1"1/4	SFS604ST	26,39
6000 PSI	45	1"1/2	SFS605ST	33,43
6000 PSI	60	2"	SFS606ST	55,40

## Cono soldable tubo métrico sin junta

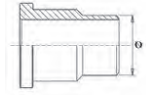

Collet à souder tube métrique sans o'ring  
Welding adaptor for metric tube without o'ring  
Adattatore a saldare per tubo Metrico sin o'ring

SERIE	Ø ext	TAMAÑO SIZE	REFERENCIA PART N°	€
3000 PSI	16	1/2"	SFS301STC	14,96
3000 PSI	25	3/4"	SFS302STC	16,72
3000 PSI	30	1"	SFS303STC	17,63
3000 PSI	38	1"1/4	SFS304STC	22,88
3000 PSI	45	1"1/2	SFS305STC	29,04
3000 PSI	60	2"	SFS306STC	37,81
3000 PSI	70	2"1/2	SFS307STC	29,04
3000 PSI	80	3"	SFS308STC	67,71
3000 PSI	100	3"1/2	SFS309STC	115,23
3000 PSI	114.3	4"	SFS310STC	129,28
3000 PSI	139.7	5"	SFS311STC	159,17
6000 PSI	16	1/2"	SFS601STC	15,84
6000 PSI	25	3/4"	SFS602STC	20,24
6000 PSI	30	1"	SFS603STC	22,88
6000 PSI	38	1"1/4	SFS604STC	26,40
6000 PSI	45	1"1/2	SFS605STC	33,44
6000 PSI	60	2"	SFS606STC	55,41

## Cono Cetop soldable exterior

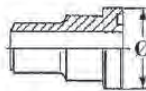

Collet Cetop à souder  
Cetop welding adaptor  
Adattatore a saldare Cetop

SERIE	Ø ext	TAMAÑO SIZE	REFERENCIA PART N°	€
3000 PSI	18	3/8"	COD38ST250	13,06
6000 PSI	18	3/8"	COD38ST400	15,68

## Bridas Cetop

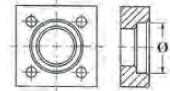

Brides Cetop  
Cetop flanges  
Flangia Cetop

SERIE	Ø in	TAMAÑO SIZE	REFERENCIA PART N°	€
3000 PSI	31	1/2"	CET12ST250	13,06

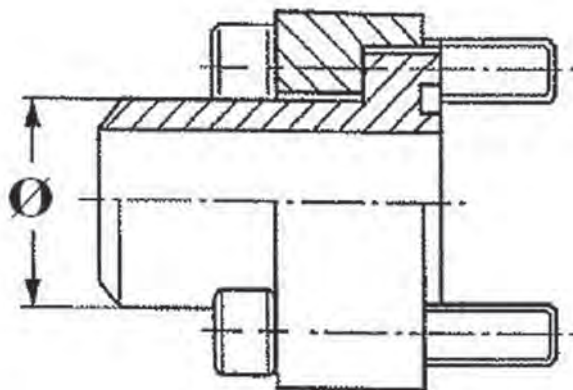
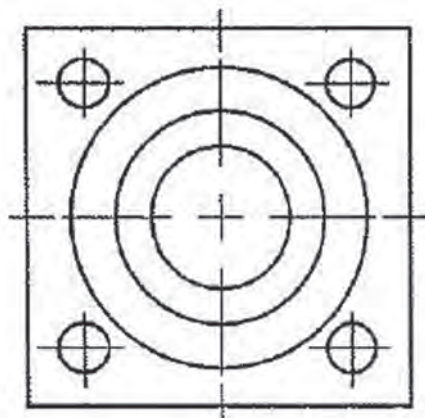

► **Características comunes** | Données communes | Common characteristics | Caratteristiche comuni

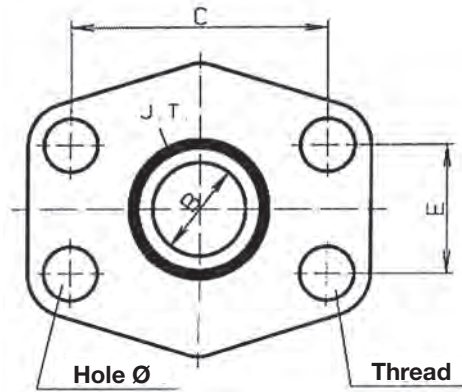

**Bridas 3000 PSI** | Brides 3000 PSI | Flanges 3000 PSI | Flange 3000 PSI

Tamaño   Taille   Size   Misura	Max. pre.   Max. pre.   Max. pre.   Max. pre.	B	C	E	O'ring   O'ring   O'ring   O'ring	Ø	Rosca   Filetage   Thread   Filetto
1/2"	345 bar	13	38,1	17,48	18,64x3,53	9	M8
3/4"	345 bar	19	47,63	22,23	24,99x3,53	11	M10
1	345 bar	25	52,37	26,19	32,92x3,53	11	M10
1" 1/4	276 bar	32	58,72	30,18	37,70x3,53	11,5	M10
1" 1/2	207 bar	38	69,85	35,71	47,22x3,53	13,5	M12
2	207 bar	51	77,77	42,88	56,74x3,53	13,5	M12
2 1/2"	172 bar	63	88,9	50,8	66,27x3,53	13,5	M12
3	138 bar	73	106,38	61,93	85,32x3,53	17,5	M16
3" 1/2	34 bar	89	120,65	69,85	98,02x3,53	17,5	M16
4	34 bar	99	130,18	77,77	110,72x3,53	17,5	M16

**Bridas 6000 PSI** | Brides 6000 PSI | Flanges 6000 PSI | Flange 6000 PSI

Tamaño   Taille   Size   Misura	Max. pre.   Max. pre.   Max. pre.   Max. pre.	B	C	E	O'ring   O'ring   O'ring   O'ring	Ø	Rosca   Filetage   Thread   Filetto
1/2"	414 bar	13	40,49	18,24	18,64x3,53	9	M8
3/4"	414 bar	19	50,8	23,8	24,99x3,53	11	M10
1	414 bar	25	57,15	27,76	32,92x3,53	13	M12
1" 1/4	414 bar	32	66,68	31,75	37,70x3,53	15	M14
1" 1/2	414 bar	38	79,38	36,5	47,22x3,53	17	M16
2	414 bar	51	96,82	44,45	56,74x3,53	21	M20
2 1/2"	414 bar	63	123,8	58,7	66,27x3,53	-	-







Abrazaderas para tubo

Colliers de fixation | Clamps for pipe | Collari fissatubo

218

# Abrazaderas para tubo

Colliers de fixation | Clamps for pipe | Collari fissatubo

Pipe

DIN 2353 Pipe Fittings

Gas tube fittings

JIC 37° fittings

SAE Flanges

Clamps

Machines for processing rigid pipes

## ► Serie ligera simple | Colliers de fixation simple série légère | Light serie simple clamp | Collari fissatubo serie leggera singoli 219



A40AZ

A C

APIN

AVTC

## ► Serie ligera reforzada | Colliers de fixation simple série légère renforcés | Light serie reinforced clamp | Collari fissatubo serie leggera rinforzati 220



A41AZ

APS

AVTE

## ► Dobles / paralelas | Colliers de fixation doubles | Double clamp - parallel | Collari fissatubo doppi 221



AZCFS

ADPIN

AD C

ADPS

ADVTE

## ► Serie pesada | Colliers de fixation simple série lourde | Heavy serie clamp | Collari fissatubo serie pesante 222

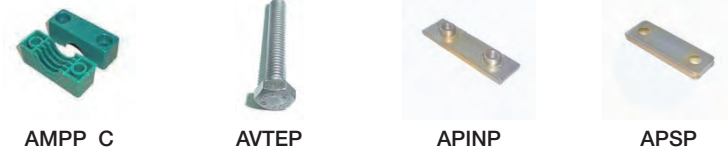

AMPP C

AVTEP

APINP

APSP

## ► Accesorios abrazaderas | Accessoires pour colliers | Accessories for clamps | Accessori per collari fissatubo 223



APAG

ADPAG

TC/TS

APT

## ► Accesorios para apilar | Accessoires empiler | Accessories for pile up | Accessori per componibili 223

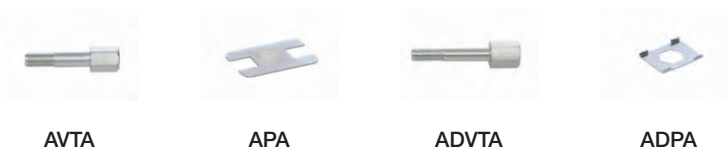

AVTA

APA

ADVTA

ADPA

## Abrazaderas para tubo

Colliers de fixation  
Clamps for pipe  
Collari fissatubo

### Abrazadera simple completa



Collier de fixation simple série légère complet  
Simple clamp  
Collare fissatubo singolo completo

DN	GRUPO GROUP	PACK MIN	REFERENCIA PART N°	€
6	1	10 uni	A40AZ06	1,62
8	1	10 uni	A40AZ08	1,62
10	1	10 uni	A40AZ10	1,62
12	1	10 uni	A40AZ12	1,62
1/4"	2	10 uni	A40AZ13.2	1,72
14	2	10 uni	A40AZ14	1,72
15	2	10 uni	A40AZ15	1,72
16	2	10 uni	A40AZ16	1,72
3/8"	2	10 uni	A40AZ16.7	1,72
18	2	10 uni	A40AZ18	1,72
19	3	10 uni	A40AZ19	1,99
20	3	10 uni	A40AZ20	1,99
1/2"	3	10 uni	A40AZ21.3	1,99
22	3	10 uni	A40AZ22	1,99
25	3	10 uni	A40AZ25	1,99
3/4"	4	10 uni	A40AZ26.7	2,24
28	4	10 uni	A40AZ28	2,24
30	4	10 uni	A40AZ30	2,24
32	5	10 uni	A40AZ32	2,93
1"	5	10 uni	A40AZ33.3	2,93
35	5	10 uni	A40AZ35	2,93
38	5	10 uni	A40AZ38	2,93
40	5	10 uni	A40AZ40	2,93
42	5	10 uni	A40AZ42	2,93
1 1/2"	6	10 uni	A40AZ48.3	4,08
50.8	6	10 uni	A40AZ50.8	4,08

Consultar plásticos en poliamida y aluminio // Plastique polyamide et aluminium, sur demande  
// Polyamide and aluminium plastics, on request // Plastica poliamide e alluminio, su richiesta

### Plásticos polipropileno



Plastique polypropylene  
Plastics polypropylene simple  
Plastica polipropilene

DN	GRUPO GROUP	REFERENCIA PART N°	€
6	1	A106C	0,72
8	1	A108C	0,72
10	1	A110C	0,72
12	1	A112C	0,72
1/4"	2	A213.2C	0,75
14	2	A214C	0,75
15	2	A215C	0,75
3/8"	2	A216.7C	0,75
16	2	A216C	0,75
18	2	A218C	0,75
19	3	A319C	0,97
20	3	A320C	0,97
1/2"	3	A321.3C	0,97
22	3	A322C	0,97
23	3	A323C	0,97
25	3	A325C	0,97
3/4"	4	A426.7C	1,17
28	4	A428C	1,17
30	4	A430C	1,17
1"	5	A533.3C	1,77
35	5	A535C	1,77
38	5	A538C	1,77
40	5	A540C	1,77
42	5	A542C	1,77
44.5	6	A644.5C	2,71
1 1/2"	6	A648.3C	2,71
50.8	6	A650.8C	2,71

### Chapas inferiores



Plaques inférieures à souder série légère

Lower plate simple  
Piastra inferiori

GRUPO GROUP	REFERENCIA PART N°	€
1	APIN1	0,80
2	APIN2	0,82
3	APIN3	0,85
4	APIN4	0,87
5	APIN5	0,90
6	APIN6	1,40

### Tornillos cabeza Allen



Vis tête six pans creux Allen

Simple Allen bolt  
Vite Allen

GRUPO GROUP	REFERENCIA PART N°	€
1	AVTC1	0,17
2	AVTC2	0,20
3	AVTC3	0,21
4	AVTC4	0,22
5	AVTC5	0,34
6	AVTC6	0,39

# Abrazaderas para tubo

Colliers de fixation  
Clamps for pipe  
Collari fissatubo

## Abrazadera reforzada completa



Collier de fixation simple série légère renforcé complet

Reinforced clamp

Collare fissatubo rin forzato completo

DN	GRUPO GROUP	PACK MIN	REFERENCIA PART N°	€
6	1	10 uni	A41AZ06	2,01
8	1	10 uni	A41AZ08	2,01
10	1	10 uni	A41AZ10	2,01
12	1	10 uni	A41AZ12	2,01
1/4"	2	10 uni	A41AZ13.2	2,14
14	2	10 uni	A41AZ14	2,14
15	2	10 uni	A41AZ15	2,14
16	2	10 uni	A41AZ16	2,14
3/8"	2	10 uni	A41AZ16.7	2,14
18	2	10 uni	A41AZ18	2,14
20	3	10 uni	A41AZ20	2,49
1/2"	3	10 uni	A41AZ21.3	2,49
22	3	10 uni	A41AZ22	2,49
25	3	10 uni	A41AZ25	2,49
3/4"	4	10 uni	A41AZ26.7	2,81
28	4	10 uni	A41AZ28	2,81
30	4	10 uni	A41AZ30	2,81
1"	5	10 uni	A41AZ33.3	3,58
35	5	10 uni	A41AZ35	3,58
38	5	10 uni	A41AZ38	3,58
40	5	10 uni	A41AZ40	3,58
42	5	10 uni	A41AZ42	3,58
44.5	6	10 uni	A41AZ44.5	4,87
1 1/2"	6	10 uni	A41AZ48.3	4,87
50.8	6	10 uni	A41AZ50.8	4,87

Consultar plásticos en poliamida y aluminio // Plastique polyamide et aluminium, sur demande  
// Polyamide and aluminium plastics, on request // Plastica poliamide e alluminio, su richiesta

## Chapas superiores



Plaques supérieures de protection série légère

Upper plate reinforced

Piastre inferiori

GRUPO GROUP	REFERENCIA PART N°	€
1	APS1	0,37
2	APS2	0,47
3	APS3	0,52
4	APS4	0,60
5	APS5	0,70
6	APS6	0,85

## Tornillos cabeza hexagonal



Vis hexagonale

Hexagonal bolt reinforced

Vite esagonale

GRUPO GROUP	REFERENCIA PART N°	€
1	AVTE1	0,15
2	AVTE2	0,17
3	AVTE3	0,20
4	AVTE4	0,22
5	AVTE5	0,28
6	AVTE6	0,34

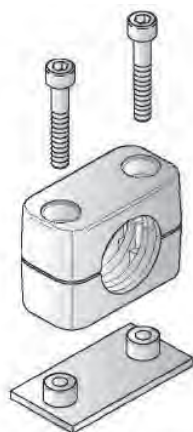

ABRAZADERA SIMPLE COMPLETA



ABRAZADERA REFORZADA COMPLETA

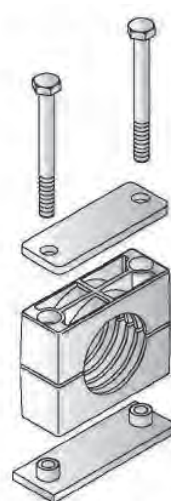

ABRAZADERA SERIE PESADA COMPLETA

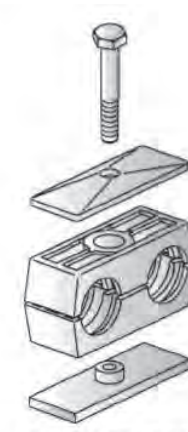

ABRAZADERA DOBLE COMPLETA

## Abrazaderas para tubo

Colliers de fixation  
Clamps for pipe  
Collari fissatubo

### Abrazaderas dobles completas



Colliers de fixation doubles complets  
Double clamp - parallel  
Collare fissatubo doppio completo

DN	GRUPO GROUP	PACK MIN	REFERENCIA PART N°	€
6	1	10 uni	AZCFS06	2,11
8	1	10 uni	AZCFS08	2,11
10	1	10 uni	AZCFS10	2,11
12	1	10 uni	AZCFS12	2,11
1/8"	2	10 uni	AZCFS13.2	2,64
14	2	10 uni	AZCFS14	2,64
15	2	10 uni	AZCFS15	2,64
16	2	10 uni	AZCFS16	2,64
3/8"	2	10 uni	AZCFS16.7	2,64
18	2	10 uni	AZCFS18	2,64
19	3	10 uni	AZCFS19	2,93
20	3	10 uni	AZCFS20	2,93
1/2"	3	10 uni	AZCFS21.3	2,93
22	3	10 uni	AZCFS22	2,93
25	3	10 uni	AZCFS25	2,93
26	4	10 uni	AZCFS26	3,38
3/4"	4	10 uni	AZCFS26.7	3,38
28	4	10 uni	AZCFS28	3,38
30	4	10 uni	AZCFS30	3,38
33	5	10 uni	AZCFS33	4,28
1"	5	10 uni	AZCFS33.3	4,28
38	5	10 uni	AZCFS38	4,28
40	5	10 uni	AZCFS40	4,28
42	5	10 uni	AZCFS42	4,28

Consultar plásticos en poliamida // Plastique polyamide, sur demande // Polyamide plastics, on request // Plastica poliamide, su richiesta

### Chapas inferiores



Plaques inférieures à souder doubles  
Lower plate double  
Piastre inferiori

GRUPO GROUP	REFERENCIA PART N°	€
1	ADPIN1	0,95
2	ADPIN2	1,17
3	ADPIN3	1,29
4	ADPIN4	1,51
5	ADPIN5	1,73

### Plásticos polipropileno



Plastiques polypropylene doubles  
Plastics polypropylene double  
Plastica polipropilene

DN	GRUPO GROUP	REFERENCIA PART N°	€
6	1	AD106C	0,80
8	1	AD108C	0,80
10	1	AD110C	0,80
12	1	AD112C	0,80
1/4"	2	AD213.2C	0,92
14	2	AD214C	0,92
15	2	AD215C	0,92
3/8"	2	AD216.7C	0,92
16	2	AD216C	0,92
18	2	AD218C	0,92
19	3	AD319C	1,12
20	3	AD320C	1,12
1/2"	3	AD321.3C	1,12
22	3	AD322C	1,12
25	3	AD325C	1,12
3/4"	4	AD426.7C	1,42
26	4	AD426C	1,42
28	4	AD428C	1,42
30	4	AD430C	1,42
1"	5	AD533.3C	2,19
33	5	AD533C	2,19
35	5	AD535C	2,19
35	5	AZCFS35	4,28
38	5	AD538C	2,19
40	5	AD540C	2,19
1"1/4	5	AD542.4C	2,19
42	5	AD542C	2,19

### Chapas superiores



Plaques supérieures de protection doubles  
Upper plate double  
Piastre superiori

GRUPO GROUP	REFERENCIA PART N°	€
1	ADPS1	0,39
2	ADPS2	0,50
3	ADPS3	0,53
4	ADPS4	0,56
5	ADPS5	0,69

### Tornillos cabeza hexagonal



Vis hexagonale  
Hexagonal bolt double  
Vite esagonale

GRUPO GROUP	REFERENCIA PART N°	€
1	ADVTE1	0,17
2	ADVTE2	0,22
3	ADVTE3	0,25
4	ADVTE4	0,29
5	ADVTE5	0,39

# Abrazaderas para tubo

Colliers de fixation  
Clamps for pipe  
Collari fissatubo

Pipe

DIN 2353 Pipe Fittings

Gas tube fittings

JIC 37° fittings

SAE Flanges

Clamps

Machines for processing rigid pipes

## Plásticos polipropileno



Plastique polypropylene  
Plastics polypropylene heavy  
Plastica polipropilene

DN	GRUPO GROUP	REFERENCIA PART N°	€
6	1	AMPP106C	2,19
8	1	AMPP108C	2,19
10	1	AMPP110C	2,19
12	1	AMPP112C	2,19
1/4"	1	AMPP113.2C	2,19
14	1	AMPP114C	2,19
15	1	AMPP115C	2,19
16	1	AMPP116C	2,19
18	1	AMPP118C	2,19
20	1	AMPP120C	2,19
20	2	AMPP220C	2,39
1/2"	2	AMPP221.3C	2,39
22	2	AMPP222C	2,39
25	2	AMPP225C	2,39
3/4"	2	AMPP226.7C	2,39
28	2	AMPP228C	2,39
30	2	AMPP230C	2,39
30	3	AMPP330C	3,38
32	3	AMPP332C	3,38
1"	3	AMPP333.3C	3,38
35	3	AMPP335C	3,38
38	3	AMPP338C	3,38
40	3	AMPP340C	3,38
1 1/4	3	AMPP342.4C	3,38
42	3	AMPP342C	3,38
45	3	AMPP345C	3,38
38	4	AMPP438C	9,60
40	4	AMPP440C	9,58
1 1/4	4	AMPP442.4C	9,58
42	4	AMPP442C	9,60
45	4	AMPP444.5C	9,58
1 1/4	4	AMPP448.4C	9,60
48	4	AMPP448C	9,58
50	4	AMPP450C	9,60
55	4	AMPP455C	9,60
2"	4	AMPP460.3C	9,60
60	4	AMPP460C	9,58
65	4	AMPP465C	9,60
70	4	AMPP470C	9,60

## Tornillos cabeza hexagonal



Vis hexagonale  
Hexagonal bolt heavy  
Vite esagonale

GRUPO GROUP	REFERENCIA PART N°	€
1	AVTEP1	0,56
2	AVTEP2	0,67
3	AVTEP3	0,78
4	AVTEP4	1,34

## Chapas inferiores



Plaques inférieures à souder série lourde  
Lower plate heavy  
Piastra inferiori

GRUPO GROUP	REFERENCIA PART N°	€
1	APINP1	3,46
2	APINP2	3,52
3	APINP3	3,86
4	APINP4	7,67

## Chapas superiores



Plaques supérieures de protection série lourde  
Upper plate heavy  
Piastra superiori

GRUPO GROUP	REFERENCIA PART N°	€
1	APSP1	1,08
2	APSP2	1,22
3	APSP3	1,42
4	APSP4	3,46

## Abrazaderas para tubo

Colliers de fixation  
Clamps for pipe  
Collari fissatubo

### Chapa agrupar abrazaderas simples



Plaque à joindre pour collier simple

Jointed plate for simple clamp

Piastra gruppo per collare fissatubo singolo

GRUPO GROUP	N° Abrazaderas Clamp qty.	REFERENCIA PART N°	€
1	10	APAG1	11,14
2	10	APAG2	11,49
3	10	APAG3	11,83

### Chapa agrupar abrazaderas dobles



Plaque à joindre pour collier double

Jointed plate for double clamp

Piastra gruppo per collare fissatubo doppio

GRUPO GROUP	N° Abrazaderas Clamp qty.	REFERENCIA PART N°	€
1	5	ADPAG1	5,67
2	5	ADPAG2	7,01
3	5	ADPAG3	7,31

### Tornillo apilar ligera



Vis pour empiler série légère

Light serie screw to pile up

Vite per piastre componibili. Serie leggera

GRUPO GROUP	REFERENCIA PART N°	€
1	AVTA1	1,32
2	AVTA2	1,57
3	AVTA3	1,62
4	AVTA4	1,72
5	AVTA5	1,84

### Chapa apilar ligera



Plaque pour empiler série légère

Light serie plate to pile up

Piastra componibili. Serie leggera

GRUPO GROUP	REFERENCIA PART N°	€
1	APA1	0,32
2	APA2	0,40
3	APA3	0,50
4	APA4	0,57
5	APA5	0,60

### Accesorios carril



Accessories pour lane

Accessories for lane

Accessori per lane

Descripción Description	REFERENCIA PART N°	€
Carril guía (Simples/Dobles)	TS14A	22,60

PVP: €/m

### Chapa atornillar Abr. Simples



Plaque à visser

Elongated weld plate

Piastra per fissaggio

GRUPO GROUP	REFERENCIA PART N°	€
1	APT1	0,87
2	APT2	0,90
3	APT3	0,92
4	APT4	0,95
5	APT5	1,12

### Tornillo apilar doble



Vis pour empiler série double

Double serie screw to pile up

Vite per piastre componibili. Serie doppia

GRUPO GROUP	REFERENCIA PART N°	€
2	ADVTA2	1,90
3	ADVTA3	2,07
4	ADVTA4	2,42
5	ADVTA5	*

Para Grupo 1: AVTA1 (ligera) / Pour le Groupe 1: AVTA1 (légère) / For Group 1: AVTA1 (Light) / Per il Gruppo 1: AVTA1 (leggera)

### Chapa apilar doble



Plaque pour empiler série double

Double serie plate to pile up

Vite per piastre componibili. Serie doppia

GRUPO GROUP	REFERENCIA PART N°	€
1	ADPA1	0,34
2/3/4/5	ADPA2	0,34

# Abrazaderas para tubo

Colliers de fixation | Clamps for pipe | Collari fissatubo

Pipe

DIN 2353 Pipe Fittings

Gas tube fittings

JIC 37° fittings

SAE Flanges

Clamps

Machines for processing rigid pipes

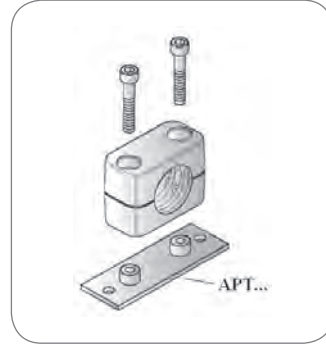
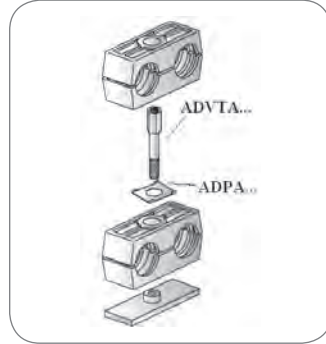
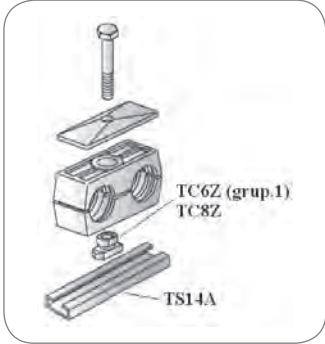
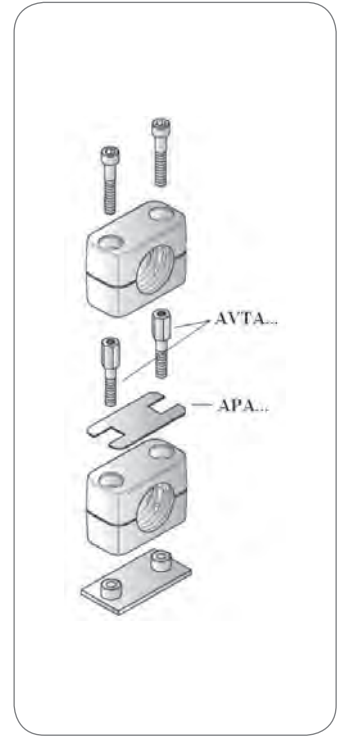
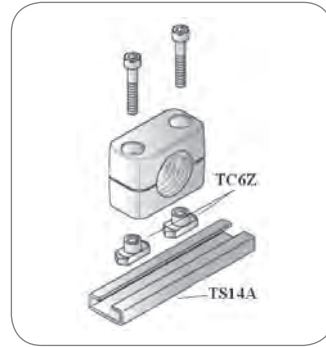
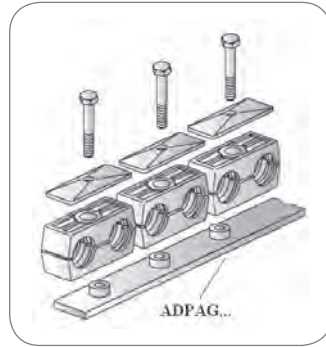
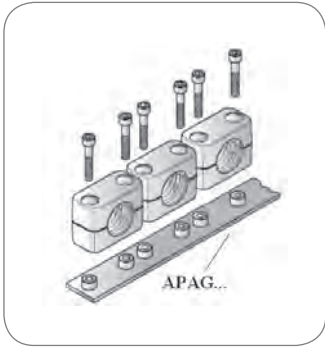

► **Artículos bajo consulta** | Articles à consulter | Items on request | Articoli su richiesta

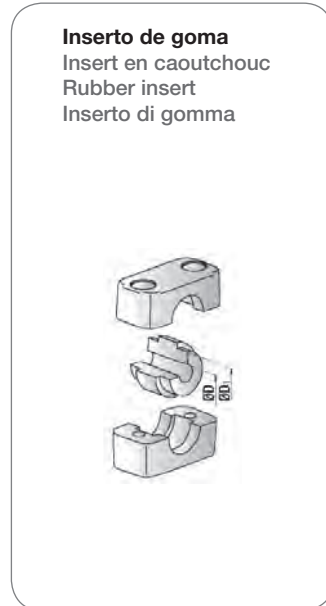
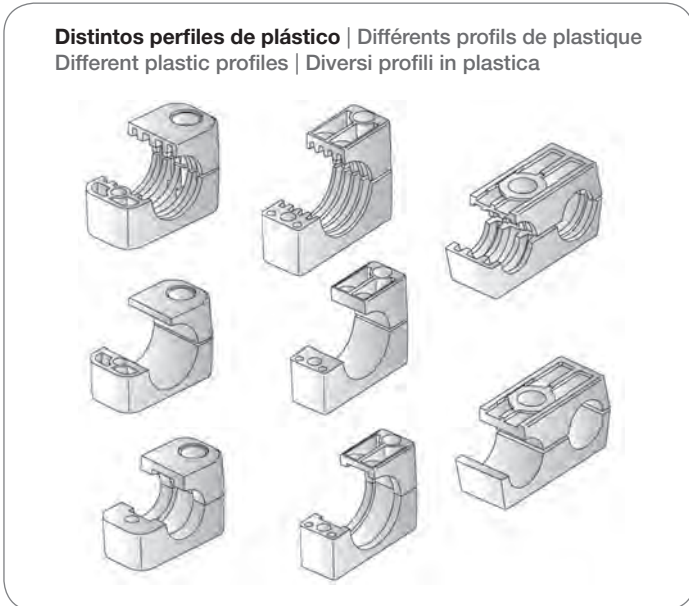



# Abrazaderas para tubo

Colliers de fixation | Clamps for pipe | Collari fissatubo

- ▶ **Bolsa de 10 unidades completas sin montar** | Sacs de 10 unités complètes non montés  
Bags of 10 complete units unassembled | Borse di 10 unità complete non montate



Pipe

DIN 2353 Pipe Fittings

Gas tube fittings

JIC 37° fittings

SAE Flanges

Clamps

Machines for processing rigid pipes



7

# Maquinaria para tubo rígido

Machines pour le tube rigide | Machines for rigid tube | Macchine per il tubo rigido

Pipe

## Dobladoras | Cintreuse | Bending machine | Curvatubi

**C-42**  
Dobladora accionamiento hidráulico | Hydraulic bending machine



Tubo   Pipe	6 → 42 x 4 mm
Potencia   Power	2"

**CMS-42**  
Dobladora accionamiento manual hidráulico | Manual bending machine with hydraulic operation



Tubo   Pipe	6 → 42 x 4 mm
-------------	---------------

**M18 6-18**  
Dobladora manual | Manual bending machine



Tubo   Pipe	6 → 18 mm
-------------	-----------

DIN 2353 Pipe Fittings

Gas tube fittings

## Radios de curvatura | Rayon de courbure | Bending radius | Raggi di curvatura

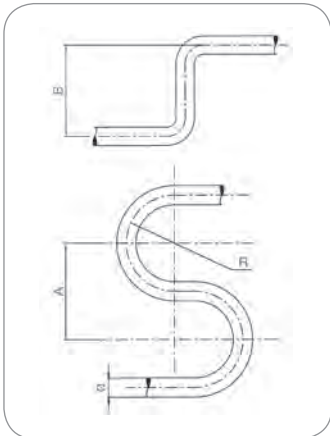

Tubo Ø Tube Ø	Radio de curvatura Bending radius (mm)	Máx. ángulo de curvatura Max. bending angle	A (mm)	B (mm)
6	15	170°	60	70
8	16.5	170°	60	70
10	27.5	170°	70	115
12	32.7	170°	80	120
14	46	170°	110	180
15	46	170°	110	180
16	48	170°	110	180
18	48	170°	110	190
20	66	160°	140	230
22	66	160°	140	240
25	81.5	160°	170	270
28	81	160°	180	300
30	98.5	150°	220	300
32	101	150°	220	300
35	125.5	120°	250	440
38	116	120°	250	440
42	126	120°	250	440
1/8"	27.5	170°	70	115
1/4"	46	170°	110	180
3/8"	48	170°	110	180
1/2"	66	160°	140	240
3/4"	81	160°	180	300
1"	125.5	120°	250	440
1 1/4"	126	120°	250	440

Matrices de doblado | Bending tools



JIC 37° fittings

SAE Flanges

Clamps

## Desbarbadora | Machine a ebavurer | Deburring machine | Sbavatore

**S01**



Desbarbado exterior External deburring	6 → 42 mm
Desbarbado interior Internal deburring	6 → 42 mm
Potencia motor Engine power	0,18 KW
R.P.M.   R.P.M.	75

Útiles desbarbado incluidos | Deburring tools included



**Otras máquinas: consultar** | Autres machines, sur demande | Other machines, on request | Altre macchine, sur richiesta



Machines for processing rigid pipes

## Maquinaria para tubo rígido

Machines pour le tube rigide | Machines for rigid tube | Macchine per il tubo rigido

### Montaje racores DIN 2353 y JIC 37° | Montage du raccord DIN 2353 et JIC 37° | DIN 2353 and JIC 37° pipe fittings assembly | Assemblaggio del raccordo ad anello DIN 2353 e JIC 37°

#### USFL/01 MAN Accionamiento manual hidráulico | Manual device with hydraulic operation



#### USFL/01 Accionamiento hidráulico | Hydraulic device



	US-FL/01	US-FL/01 MAN	
Premontaje DIN 2353 24°   Preassembling DIN 2353 24°	6 → 42 x 4 mm	6 → 42 x 4 mm	
Abocardado JIC 37°   37° JIC Flaring	6 → 42 x 4 mm	6 → 42 x 4 mm	Con BL

#### Matrices | Tools



#### Bloque BL JIC 37° | BL Block JIC 37°



#### Machos | Males



#### Portaherramientas opcional Tool handler optional

### Centro de trabajo | Unité multifonctionnelle | Multi-functional unit | Unità multifunzione

	Mini   Mini	Completo   Complete
Premontaje DIN 2353 24° Pre-assembling	6 → 42 x 4 mm	6 → 42 x 4 mm
Abocardado JIC 27° 37° Flaring	6 → 42 x 4 mm	6 → 42 x 4 mm
Curvatura Bending	6 → 42 x 4 mm	6 → 42 x 4 mm
Desbarbado Deburring	Máx. ø 42 x 4 mm	Máx. ø 42 x 4 mm

#### Machos | Males



#### Matrices | Tools

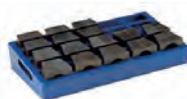

#### Completo | Complete



#### Mini | Mini



### Otras máquinas: consultar | Autres machines, sur demande | Other machines, on request | Altre macchine, sur richiesta



Tubo 6 → 15 mm  
Tube 6 → 15 mm



Gama de productos. Para más información soliciten nuestros catálogos generales o visiten nuestra página web  
 Gamme de produits. Pour plus d'information, nous vous prions de nous demander nos catalogues generaux ou visiter notre web-site  
 Products range. For any further information, please, ask for our general catalogues or visit our web-site  
 Gamma di Prodotti. Per ulteriori informacón di ricuidete il nostri cataloghi o visitate la Nostra pagina web

## INOX AISI 316L

**RACORES PARA TUBERÍA FLEXIBLE**  
*EMBOUTS POUR FLEXIBLES*  
 CRIMP FITTINGS FOR HOSES  
 RACCORDI PER TUBO FLESSIBILE



**INOX COARRUGADO**  
*INOX ONDULEUX*  
 CONVOLUTED STAINLESS STEEL  
 INOX CORRUGATO



**ACCESORIOS**  
*ACCESSOIRES*  
 ACCESSORIES  
 ACCESSORI



**RACORES TUBO RÍGIDO**  
*RACCORDS TUBE RIGIDE*  
 PIPE FITTINGS  
 RACCORDI PER TUBO RIGIDO



**RACORES INDUSTRIALES**  
*EMBOUTS INDUSTRIELS*  
 INDUSTRIAL FITTINGS  
 RACCORDI INDUSTRIALI



# Accesorios

Accessoires  
Accessories  
Accessori



## Adaptadores

Adapteurs  
Adaptors  
Adattatori

1

## Accesorios ORFS

Accessoires ORFS  
ORFS Accessories  
Accessori ORFS

2

## Enchufes rápidos

Coupleurs rapides  
Quick-release couplings  
Innesti rapidi

3

## Llaves paso, desviadores y racores giratorios

Robinets, diviseurs et raccords tournants  
Ball valves, diverters and swivel fittings  
Rubinetti, deviatori, raccordi girevoli

4

## Protecciones

Protections/ressorts  
Protections  
Protezioni

5



# Adaptadores

Adapteurs

Adaptors

Adattatori

# 1

Adaptadores BSP

Adaptateurs BSP | BSP Adaptors | Adattatori BSP

236

# Adaptadores BSP

Adapteurs BSP | BSP Adaptors | Adattatori BSP

Adaptors

ORFS

Quick-release couplings

Ball valves, diverters

Protections

## ► Uniones rectas macho | Adapteur droit mâle-mâle | Straight adaptors male | Adattatori diritti maschio

239

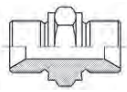

A1010

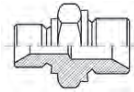

A1020

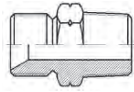

S1014

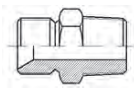

S1012

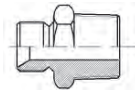

A1022

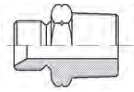

A1024

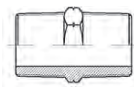

A1015

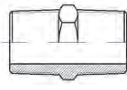

A1016

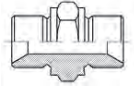

S1016

## ► Uniones rectas macho-hembra | Adapteur mâle-femelle | Adaptors male-female | Adattatori diritti maschio-femmina

240

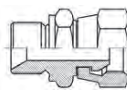

A1170



A1173

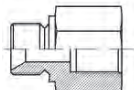

A1050

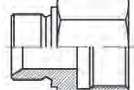

S1061

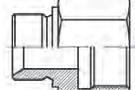

S106218

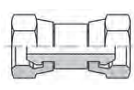

A1172

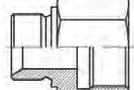

A1060

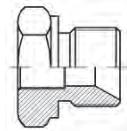

A1150

## ► Tapones | Bouchons adapteur | Plugs | Tappi

242



A1072

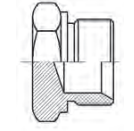

A1070



A1075



A1073

## ► Uniones hembra y pasatabiques | Unions femelle et passe cloison | Adaptors female and bulkheads | Adattatori femmina e passaparete

242

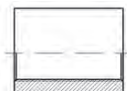

A1310



S103110

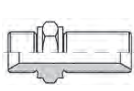

A1160

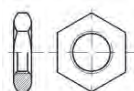

A1272

## ► Orientables | Adapteurs banjo | Banjos | Adattatori a occhio

243

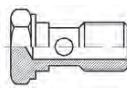

A1090

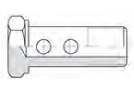

A1094

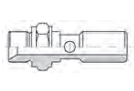

A1092

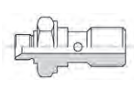

A1093

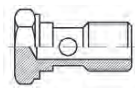

S1092

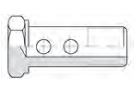

A1096

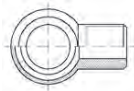

A1140

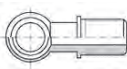

A1112

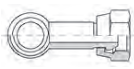

A1111

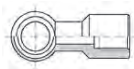

A1113

► **Soldables** | Adapteurs à souder | Weldable adaptors | Adattatori a saldare

245

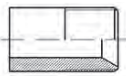

A1290

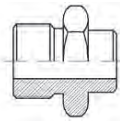

A1030

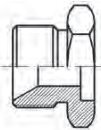

A1031

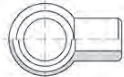

A1141

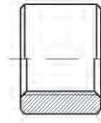

A1311

► **Codos accesoriales (tubo)** | Adapteurs coudes | Accessorial elbows | Adattatori a 90° tubolari

246



A1194

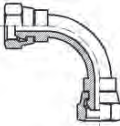

A1196



A1195

► **Codos en forja** | Adapteurs coudes en forge | Forging elbows | Adattatori a 90° forgiati

246

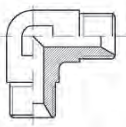

S1190

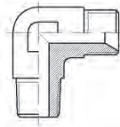

S1192

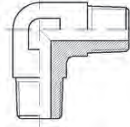

S1195

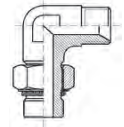

S1197



S1198

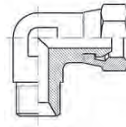

S1193

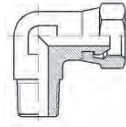

S1199

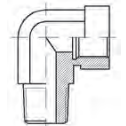

S1194

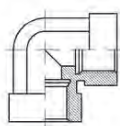

S1196



S1185

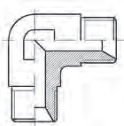

S860

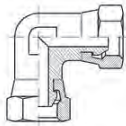

S1183

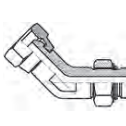

S1191

► **Te en forja** | Adapteurs Tés en forge | Forging Tees | Adattatori a T forgiati

248

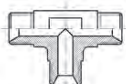

S1220

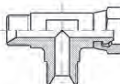

S1223

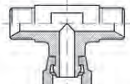

S1224

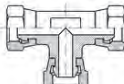

S1225

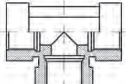

S1226



S1229

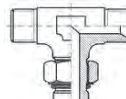

S1228

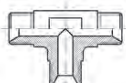

S865

► **Codos y Te en bloque (cuadrado)** | Adapteurs coudes et Tés en bloque | Square elbows and Tees | Adattatori a 90° e T da quadro senza saldatura

249

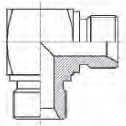

A1192

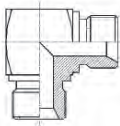

A2190

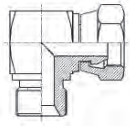

A2193

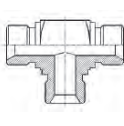

A2220

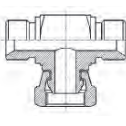

A2224

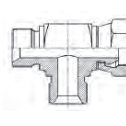

A2222

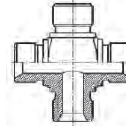

A2223

► **Juntas metal Buna y arandelas** | Bague BS | Bonded seals | Rondelle e rondelle Bonded

251

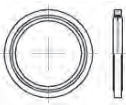

T210

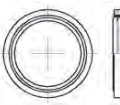

T320

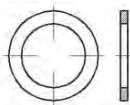

A1332

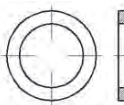

A1330



## Adaptadores BSP

Adapteurs BSP  
BSP Adaptors  
Adattatori BSP

### Adaptador macho-macho BSP (60°)

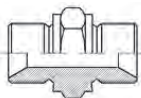

Adapteur mâle BSP x mâle BSP (60°)

Adaptor BSP male-BSP male (60°)

Niples di giunzione BSP (60°)

ROSCA THREAD		REFERENCIA PART N°	€
1/8" BSP	1/8" BSP	A101002	0,58
1/4" BSP	1/4" BSP	A101004	0,66
3/8" BSP	3/8" BSP	A101006	0,94
1/2" BSP	1/2" BSP	A101008	1,41
5/8" BSP	5/8" BSP	A101010	2,50
3/4" BSP	3/4" BSP	A101012	2,37
1" BSP	1" BSP	A101016	4,19
1"1/4 BSP	1"1/4 BSP	A101020	7,13
1"1/2 BSP	1"1/2 BSP	A101024	11,81
2" BSP	2" BSP	A101032	22,02

### Adaptador macho BSP (60°) - macho BSPT

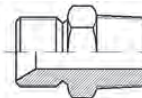

Adapteur mâle BSP (60°) x mâle gaz conique (BSPT)

Adaptor BSP male- BSPT male (60°)

Niples di congiunzione BSP (60°) - BSPT

ROSCA THREAD		REFERENCIA PART N°	€
1/8" BSP	1/8" BSPT	S101202	0,97
1/4" BSP	1/4" BSPT	S101204	1,08
3/8" BSP	3/8" BSPT	S101206	1,16
1/2" BSP	1/2" BSPT	S101208	1,55
3/4" BSP	3/4" BSPT	S101212	3,10
1" BSP	1" BSPT	S101216	6,87
1"1/4 BSP	1"1/4 BSPT	S101220	9,29
1"1/2 BSP	1"1/2 BSPT	S101224	12,59
2" BSP	2" BSPT	S101232	25,95

### Reductor macho-macho BSP (60°)

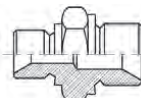

Reducteur mâle BSP x mâle BSP (60°)

Reducer adaptor BSP male-BSP male (60°)

Niples di riduzione BSP (60°)

ROSCA THREAD		REFERENCIA PART N°	€
1/8" BSP	1/4" BSP	A10200204	0,82
1/8" BSP	3/8" BSP	A10200206	1,11
1/4" BSP	3/8" BSP	A10200406	1,08
1/4" BSP	1/2" BSP	A10200408	1,48
3/8" BSP	1/2" BSP	A10200608	1,39
3/8" BSP	3/4" BSP	A10200612	2,39
1/2" BSP	3/4" BSP	A10200812	1,82
1/2" BSP	1" BSP	A10200816	4,26
5/8" BSP	1/2" BSP	A10201008	3,04
5/8" BSP	3/4" BSP	A10201012	3,71
3/4" BSP	1" BSP	A10201216	4,44
3/4" BSP	1"1/4 BSP	A10201220	7,34
1" BSP	1"1/4 BSP	A10201620	7,34
1" BSP	1"1/2 BSP	A10201624	13,87
1"1/4 BSP	1"1/2 BSP	A10202024	11,64
1"1/4 BSP	2" BSP	A10202032	20,06
1"1/2 BSP	2" BSP	A10202432	20,06

### Reductor macho BSP (60°) - macho BSPT



Reducteur mâle BSP (60°) x mâle gaz conique (BSPT)

Reducer adaptor BSP male (60°)-BSPT male

Niples di riduzione BSP (60°) - BSPT

ROSCA THREAD		REFERENCIA PART N°	€
1/4" BSP	3/8" BSPT	A10220406	2,21
3/8" BSP	1/2" BSPT	A10220608	2,94
3/8" BSP	3/4" BSPT	A10220612	3,87
1/2" BSP	1/4" BSPT	A10220804	3,16
1/2" BSP	3/4" BSPT	A10220812	5,02
3/4" BSP	1" BSPT	A10221216	7,07
1"1/4 BSP	1" BSPT	A10222016	15,21
1 1/2" BSP	1 1/4" BSPT	A10222420	65,46
1"1/2 BSP	2" BSPT	A10222432	47,77

### Adaptador macho BSP (60°) - macho NPT

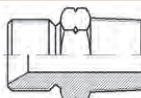

Adapteur mâle BSP (60°) x mâle briggs (NPT)

Adaptor BSP male (60°)-NPT male

Niples di congiunzione BSP (60°) - NPT

ROSCA THREAD		REFERENCIA PART N°	€
1/8" BSP	1/8" NPT	S101402	1,38
1/4" BSP	1/4" NPT	S101404	1,16
3/8" BSP	3/8" NPT	S101406	1,40
1/2" BSP	1/2" NPT	S101408	3,06
3/4" BSP	3/4" NPT	S101412	4,33
1" BSP	1" NPT	S101416	9,80
1"1/4 BSP	1"1/4 NPT	S101420	15,78
1"1/2 BSP	1"1/2 NPT	S101424	23,60
2" BSP	2" NPT	S101432	54,24

### Reductor macho BSP (60°) - macho NPT

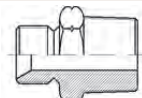

Reducteur mâle BSP (60°) x mâle briggs (NPT)

Reducer adaptor BSP male (60°)-NPT male

Niples di riduzione BSP (60°) - NPT

ROSCA THREAD		REFERENCIA PART N°	€
1/4" BSP	1/8" NPT	A10240402	2,22
1/4" BSP	3/8" NPT	A10240406	2,55
1/4" BSP	1/2" NPT	A10240408	3,70
3/8" BSP	1/2" NPT	A10240608	3,70
1/2" BSP	3/8" NPT	A10240806	4,03
1/2" BSP	3/4" NPT	A10240812	5,92
3/4" BSP	1/2" NPT	A10241208	6,85
3/4" BSP	1" NPT	A10241216	11,35

## Adaptadores BSP

Adapteurs BSP  
BSP Adaptors  
Adattatori BSP

### Adaptador macho-macho NPT

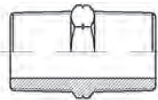

Adapteur mâle briggs (NPT) x mâle briggs (NPT)

Adaptor NPT male-NPT male

Niples di congiunzione NPT

ROSCA THREAD		REFERENCIA PART N°	€
1/4" NPT	1/4" NPT	A10150404	1,51
3/8" NPT	3/8" NPT	A10150606	2,18
1/2" NPT	1/2" NPT	A10150808	2,74
3/4" NPT	3/4" NPT	A10151212	4,93
1" NPT	1" NPT	A10151616	6,90

### Adaptador macho-macho Métrico (60°)

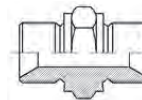

Adapteur mâle DIN x mâle DIN Métrique (60°)

Adaptor Metric male-male (60°)

Niples di giunzione Metrico (60°)

ROSCA THREAD		REFERENCIA PART N°	€
M12x1.5	M12x1.5	S101612	2,10
M14x1.5	M14x1.5	S101614	2,24
M16x1.5	M16x1.5	S101616	2,51
M18x1.5	M18x1.5	S101618	3,78
M22x1.5	M22x1.5	S101622	4,10
M26x1.5	M26x1.5	S101626	5,66

### Adaptador macho-macho BSPT

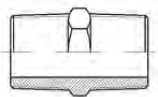

Adapteur mâle gaz conique (BSPT) x mâle gaz conique (BSPT)

Adaptor BSPT male-BSPT male

Niples di congiunzione BSPT

ROSCA THREAD		REFERENCIA PART N°	€
1/4" BSPT	1/4" BSPT	A10160404	1,70
3/8" BSPT	3/8" BSPT	A10160606	2,46
1/2" BSPT	1/2" BSPT	A10160808	3,08
3/4" BSPT	3/4" BSPT	A10161212	4,35
1" BSPT	1" BSPT	A10161616	7,47

### Adap. macho - hembra giratoria BSP (60°)



Adapteur mâle BSP x femelle tournante BSP (60°)

Adaptor BSP male-BSP swivel female (60°)

Niples di riduzione maschio-femmina girevole BSP (60°)

ROSCA THREAD		REFERENCIA PART N°	€
1/4" BSP	1/4" BSP	A117004	1,84
3/8" BSP	3/8" BSP	A117006	1,94
1/2" BSP	1/2" BSP	A117008	2,71
3/4" BSP	3/4" BSP	A117012	4,19
1" BSP	1" BSP	A117016	8,20
1"1/4 BSP	1"1/4 BSP	A117020	17,62
1"1/2 BSP	1"1/2 BSP	A117024	21,64

### Reductor macho - hembra giratoria BSP (60°)

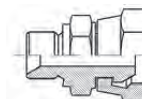

Reducteur mâle BSP x femelle tournante BSP (60°)

Reducer BSP male-BSP swivel female (60°)

Niples di riduzione maschio-femmina girevole BSP (60°)

ROSCA THREAD		REFERENCIA PART N°	€
M 1/8" BSP	H 1/4" BSP	A11730204	1,70
M 1/4" BSP	H 3/8" BSP	A11730406	2,34
M 3/8" BSP	H 1/2" BSP	A11730608	2,76
M 1/2" BSP	H 3/4" BSP	A11730812	4,42
M 3/4" BSP	H 1" BSP	A11731216	7,19
M 3/4" BSP	H 1"1/4 BSP	A11731220	32,01
M 1" BSP	H 1"1/4 BSP	A11731620	16,64
M 1"1/4 BSP	H 1"1/2 BSP	A11732024	31,25
M 1" 1/2 BSP	H 2" BSP	A11732432	50,12

## Adaptadores BSP

Adapteurs BSP  
BSP Adaptors  
Adattatori BSP

### Prolongador macho - hembra fija BSP (60°)

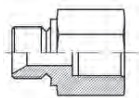

Prolongateur mâle BSP x femelle gaz fixe (60°)

Adaptor BSP male-BPS fixed female (60°)

Prolunga maschio-femmina BSP (60°)

ROSCA THREAD		REFERENCIA PART N°	€
1/8" BSP	1/8" BSP	A105002	1,04
1/4" BSP	1/4" BSP	A105004	1,03
3/8" BSP	3/8" BSP	A105006	1,52
1/2" BSP	1/2" BSP	A105008	2,00
3/4" BSP	3/4" BSP	A105012	2,84
1" BSP	1" BSP	A105016	4,40
1"1/4 BSP	1"1/4 BSP	A105020	9,52
1"1/2 BSP	1"1/2 BSP	A105024	16,79
2" BSP	2" BSP	A105032	24,40

### Reductor macho BSP (60°) - hembra fija Métrica

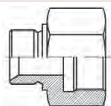

Reducteur mâle BSP (60°) x femelle fixe Métrique

Reducer adaptor BSP male (60°) - Metric fixed female

Niples di riduzione maschio BSP (60°)-femmina fissa Metrica

ROSCA THREAD		REFERENCIA PART N°	€
3/8" BSP	M14x1.5	S10610614	7,00
3/8" BSP	M18x1.5	S10610618	6,47
1/2" BSP	M18x1.5	S10610818	7,11
1/2" BSP	M20x1.5	S10610820	11,19
1/2" BSP	M22x1.5	S10610822	10,09

### Reductor macho Métrico (60°) - hembra fija BSP

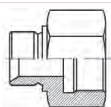

Reducteur mâle Métrique (60°) x femelle fixe gaz

Reducer adaptor Metric male (60°) - BSP fixed female

Niples di riduzione maschio Metrico (60°)-femmina fissa BSP

ROSCA THREAD		REFERENCIA PART N°	€
M18x1.5	1/4" BSP	S10621804	4,44
M18x1.5	3/8" BSP	S10621806	4,44
M18x1.5	1/2" BSP	S10621808	4,59

### Adap. hembra giratoria - hembra giratoria BSP (60°)

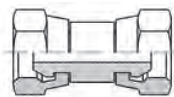

Adapteur femelle tournante BSP x femelle tournante BSP (60°)

Adaptor BSP swivel female - BSP swivel female (60°)

Niples femminas-femmina girevole BSP (60°)

ROSCA THREAD		REFERENCIA PART N°	€
1/4" BSP	1/4" BSP	A117204	2,51
3/8" BSP	3/8" BSP	A117206	3,26
1/2" BSP	1/2" BSP	A117208	4,93
3/4" BSP	3/4" BSP	A117212	6,51
1" BSP	1" BSP	A117216	10,60
1" 1/4 BSP	1" 1/4 BSP	A117220	29,98
1" 1/2 BSP	1" 1/2 BSP	A117224	43,86
2" BSP	2" BSP	A117232	108,65

### Reductor macho - hembra fija BSP (60°)

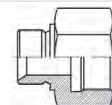

Prolongateur reducteur mâle BSP x femelle gaz fixe (60°)

Reducer adaptor BPS male- BSP fixed female (60°)

Prolunga di riduzione maschio-femmina BSP (60°)

ROSCA THREAD		REFERENCIA PART N°	€
M 1/8" BSP	H 1/4" BSP	A10600204	1,22
M 1/8" BSP	H 3/8" BSP	A10600206	1,30
M 1/4" BSP	H 1/8" BSP	A10600402	1,21
M 1/4" BSP	H 3/8" BSP	A10600406	1,59
M 1/4" BSP	H 1/2" BSP	A10600408	2,74
M 3/8" BSP	H 1/8" BSP	A10600602	2,25
M 3/8" BSP	H 1/4" BSP	A10600604	1,47
M 3/8" BSP	H 1/2" BSP	A10600608	2,09
M 3/8" BSP	H 3/4" BSP	A10600612	2,96
M 1/2" BSP	H 1/4" BSP	A10600804	2,74
M 1/2" BSP	H 3/8" BSP	A10600806	2,09
M 1/2" BSP	H 3/4" BSP	A10600812	2,16
M 1/2" BSP	H 1" BSP	A10600816	4,76
M 3/4" BSP	H 3/8" BSP	A10601206	3,03
M 3/4" BSP	H 1/2" BSP	A10601208	2,94
M 3/4" BSP	H 1" BSP	A10601216	4,51
M 3/4" BSP	H 1 1/4" BSP	A10601220	10,31
M 1" BSP	H 1/2" BSP	A10601608	4,76
M 1" BSP	H 3/4" BSP	A10601612	4,70
M 1" BSP	H 1"1/4 BSP	A10601620	10,31
M 1"1/4 BSP	H 1" BSP	A10602016	8,98
M 1 1/4" BSP	H 2" BSP	A10602032	58,76
M 1" 1/2 BSP	H 1" 1/4 BSP	A10602420	28,00
M 1"1/2 BSP	H 2" BSP	A10602432	58,76

### Tapón reductor macho - hembra fija BSP (60°)

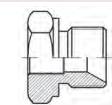

Bouchon reducteur mâle BSP x femelle gaz fixe (60°)

Reducer plug BSP male-BSP fixed female (60°)

Tappo di riduzione maschio-femmina BSP Tappo di riduzione maschio-femmina BSP (60°)

ROSCA THREAD		REFERENCIA PART N°	€
M 1/4" BSP	H 1/8" BSP	A11500402	0,81
M 3/8" BSP	H 1/8" BSP	A11500602	1,19
M 3/8" BSP	H 1/4" BSP	A11500604	1,14
M 1/2" BSP	H 1/4" BSP	A11500804	1,55
M 1/2" BSP	H 3/8" BSP	A11500806	1,62
M 3/4" BSP	H 3/8" BSP	A11501206	2,45
M 3/4" BSP	H 1/2" BSP	A11501208	2,30
M 1" BSP	H 1/2" BSP	A11501608	4,11
M 1" BSP	H 3/4" BSP	A11501612	3,94
M 1"1/4 BSP	H 3/4" BSP	A11502012	6,90
M 1"1/4 BSP	H 1" BSP	A11502016	6,90
M 1"1/2 BSP	H 1"1/4 BSP	A11502420	9,84
M 2" BSP	H 1" 1/4 BSP	A11503220	19,66
M 2" BSP	H 1"1/2 BSP	A11503224	21,37



## Adaptadores BSP

Adapteurs BSP  
BSP Adaptors  
Adattatori BSP

### Tapón hembra hexagonal rosca BSP

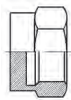

Bouchon femelle gaz  
BSP fixed female plug  
Tappo femmina fissa BSP

ROSCA THREAD	REFERENCIA PART N°	€
1/8" BSP	A107202	1,21
1/4" BSP	A107204	1,21
3/8" BSP	A107206	1,50
1/2" BSP	A107208	2,06
3/4" BSP	A107212	2,70
1" BSP	A107216	3,99
1"1/4 BSP	A107220	17,41
1"1/2 BSP	A107224	26,67
2" BSP	A107232	40,32

### Tapón hembra giratoria BSP (60°)

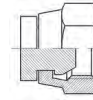

Bouchon femelle tournante BSP (60°)  
BSP swivel female plug (60°)  
Tappo femmina girevole BSP (60°)

ROSCA THREAD	REFERENCIA PART N°	€
1/4" BSP	A107504	1,05
3/8" BSP	A107506	1,42
1/2" BSP	A107508	1,95
3/4" BSP	A107512	2,94
1" BSP	A107516	4,74
1"1/4 BSP	A107520	10,99
1"1/2 BSP	A107524	16,01
2" BSP	A107532	26,49

### Tapón macho hexagonal rosca BSP (60°)

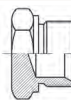

Bouchon mâle BSP (60°)  
BSP hexagonal male plug (60°)  
Tappo maschio esagonale BSP (60°)

ROSCA THREAD	REFERENCIA PART N°	€
1/8" BSP	A107002	0,67
1/4" BSP	A107004	0,67
3/8" BSP	A107006	0,88
1/2" BSP	A107008	1,23
3/4" BSP	A107012	2,06
1" BSP	A107016	3,42
1"1/4 BSP	A107020	6,97
1"1/2 BSP	A107024	9,35
2" BSP	A107032	18,84

### Tapón macho hexagonal rosca Métrica

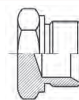

Bouchon mâle Métrique (60°)  
Metric hexagonal male plug  
Tappo maschio esagonale Metrico

ROSCA THREAD	REFERENCIA PART N°	€
M10x1	A10731001	2,48
M12x1.5	A10731215	2,52
M14x1.5	A10731415	2,99
M16x1.5	A10731615	3,24
M18x1.5	A10731815	3,52
M20x1.5	A10732015	4,19
M22x1.5	A10732215	5,15

### Manguito roscado hembra BSP redondo

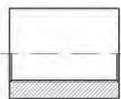

Manchon femelle gaz x femelle gaz ronde  
Adaptor BSP female fixed-BSP female fixed  
Manicoto femmina - femmina BSP

ROSCA THREAD	REFERENCIA PART N°	€
1/8" BSP	A131002	0,87
1/4" BSP	A131004	0,96
3/8" BSP	A131006	1,31
1/2" BSP	A131008	1,83
3/4" BSP	A131012	2,78
1" BSP	A131016	5,48
1" 1/4 BSP	A131020	6,35
1"1/2 BSP	A131024	9,31
2" BSP	A131032	13,05

### Manguito roscado hembra BSP hexagonal

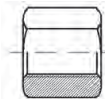

Manchon femelle gaz x femelle gaz hexagonal  
Hexagonal adaptor BSP fixed female-BSP fixed female  
Prolunga esagonale femmina-femmina BSP

ROSCA THREAD	REFERENCIA PART N°	€
1/4" BSP	S1031004	1,65
3/8" BSP	S1031006	2,26
1/2" BSP	S1031008	1,98
3/4" BSP	S1031012	3,39
1" BSP	S1031016	6,78
1" 1/4 BSP	S1031020	17,31
1" 1/2 BSP	S1031024	23,22

## Adaptadores BSP

Adaptateurs BSP  
BSP Adaptors  
Adattatori BSP

### Pasatabiques sin tuerca BSP cono 60°

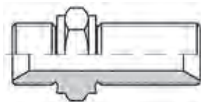

Passe-cloison mâle BSP x mâle BSP sans équiper (60°)  
Straight bulkhead adaptor without nuts (60°)  
Niples passaparete BSP

ROSCA THREAD		REFERENCIA PART N°	€
1/4" BSP	1/4" BSP	A116004	1,69
3/8" BSP	3/8" BSP	A116006	2,10
1/2" BSP	1/2" BSP	A116008	2,90
3/4" BSP	3/4" BSP	A116012	4,44
1" BSP	1" BSP	A116016	7,66
1" 1/4 BSP	1" 1/4 BSP	A116020	22,18
1" 1/2 BSP	1" 1/2 BSP	A116024	52,71

### Tuerca pasatabiques BSP

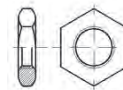

Contre-écrou passe-cloison gaz  
Conter nut for bulkhead screw-joints  
Controdado per passaparete BSP

ROSCA THREAD		REFERENCIA PART N°	€
1/4" BSP	1/4" BSP	A127204	0,42
3/8" BSP	3/8" BSP	A127206	0,59
1/2" BSP	1/2" BSP	A127208	0,87
3/4" BSP	3/4" BSP	A127212	1,25
1" BSP	1" BSP	A127216	3,62
1" 1/4 BSP	1" 1/4 BSP	A127220	5,48
1" 1/2 BSP	1" 1/2 BSP	A127224	8,15

### Tornillo orientable simple BSP

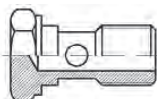

Vis creuse simple pour banjo filetage gaz  
BSP Bolt for banjo  
Bullone forato BSP

ROSCA THREAD	REFERENCIA PART N°	€
1/8" BSP	A109002	1,06
1/4" BSP	A109004	1,09
3/8" BSP	A109006	1,34
1/2" BSP	A109008	2,09
3/4" BSP	A109012	4,43
1" BSP	A109016	10,52
1" 1/4 BSP	A109020	30,17
1" 1/2 BSP	A109024	167,75

### Tornillo orientable prolongado BSP



Vis creuse simple prolongée pour banjo  
BSP Extended bolt for banjo  
Bullone forato prolungato BSP

ROSCA THREAD		REFERENCIA PART N°	€
1/4" BSP	1/4" BSP	A109204	2,56
3/8" BSP	3/8" BSP	A109206	3,26
1/2" BSP	1/2" BSP	A109208	4,44
3/4" BSP	3/4" BSP	A109212	6,35
1" BSP	1" BSP	A109216	12,60

### Tornillo orientable reductor BSP



Vis creuse simple reduite pour banjo x mâle BSP  
BSP Reducer bolt for banjo  
Bullone forato di riduzione BSP

ROSCA THREAD		REFERENCIA PART N°	€
1/4" BSP	3/8" BSP	A10930406	3,26
3/8" BSP	1/2" BSP	A10930608	4,44
1/2" BSP	3/4" BSP	A10930812	6,35
3/4" BSP	1" BSP	A10931216	12,60

### Tornillo orientable doble BSP



Vis creuse double pour banjo filetage gaz  
BSP Double bolt for banjo  
Bullone forato doppio BSP

ROSCA THREAD	REFERENCIA PART N°	€
1/4" BSP	A109404	2,24
3/8" BSP	A109406	4,65
1/2" BSP	A109408	5,54
3/4" BSP	A109412	7,47
1" BSP	A109416	15,55

## Adaptadores BSP

Adaptateurs BSP  
BSP Adaptors  
Adattatori BSP

### Tornillo orientable simple rosca Métrica

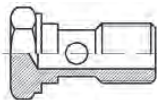

Vis creuse simple pour banjo filetage Métrique  
Metric bolt for banjo  
Bullone forato Metrico

ROSCA THREAD	REFERENCIA PART N°	€
M8x1	S109208	0,96
M10x1	S109210	1,53
M12x1.5	S109212	2,60
M14x1.5	S109214	2,23
M16x1.5	S109216	3,00
M18x1.5	S109218	4,17
M22x1.5	S109222	5,96
M26x1.5	S109226	10,15
M30x1.5	S109230	36,61

### Tornillo orientable doble rosca Métrica

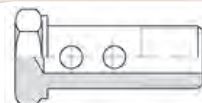

Vis creuse double pour banjo filetage Métrique  
Metric double bolt for banjo  
Bullone forato doppio Metrico

ROSCA THREAD	REFERENCIA PART N°	€
M8x1	A10960801	3,97
M10x1	A10961001	4,83
M12x1.5	A10961215	5,15
M14x1.5	A10961415	5,74
M18x1.5	A10961815	7,47

### Esférico BSP - macho BSP (60°)

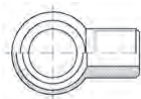

Banjo passage gaz x mâle BSP (60°)  
BSP Banjo-BSP male (60°)  
Adattatore ad occhio filettato BSP

ROSCA THREAD	Ø	REFERENCIA PART N°	€
1/8" BSP	1/8 "	A114002	4,59
1/4" BSP	1/4"	A114004	1,53
3/8" BSP	3/8"	A114006	2,76
1/2" BSP	1/2"	A114008	3,27
3/4" BSP	3/4"	A114012	12,68
1" BSP	1"	A114016	40,93

### Esférico BSP con alargadera-macho BSP (60°)

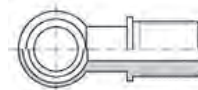

Banjo prolongé passage gaz x mâle BSP  
BSP Banjo with extension-BSP male 60°  
Adattatore ad occhio con prolunga maschio

ROSCA THREAD	Ø	REFERENCIA PART N°	€
3/8" BSP	3/8"	A111206	5,56
1/2" BSP	3/8"	A11120608	12,37
1/2" BSP	1/2"	A111208	10,63

### Esférico BSP con alargadera-hembra giratoria BSP

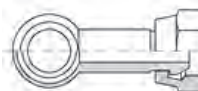

Banjo prolongé passage gaz femelle tournante  
BSP Banjo with extension-BSP swivel female  
Adattatore ad occhio con prolunga femmina girevole

ROSCA THREAD	Ø	REFERENCIA PART N°	€
1/2" BSP	1/2"	A111108	15,92

### Esférico BSP con alargadera-hembra fija BSP

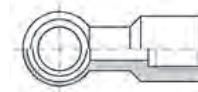

Banjo prolongé passage gaz x femelle fixe BSP  
BSP Banjo with extension-BSP fixed female  
Adattatore ad occhio con prolunga femmina fissa

ROSCA THREAD	Ø	REFERENCIA PART N°	€
3/8" BSP	3/8"	A111306	5,90
1/2" BSP	1/2"	A111308	14,58

## Adaptadores BSP

Adaptateurs BSP  
BSP Adaptors  
Adattatori BSP

### Empalme liso soldable rosca BSP (60°)

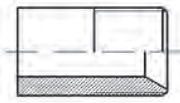

Embout mâle lisse à souder gaz cyl BSP (60°)

Welding union BSP male (60°)

Mezzo nipples tondo a saldare BSP

ROSCA THREAD	REFERENCIA PART N°	€
1/8" BSP	A129002	1,20
1/4" BSP	A129004	0,64
3/8" BSP	A129006	0,80
1/2" BSP	A129008	1,00
3/4" BSP	A129012	1,76
1" BSP	A129016	4,26
1"1/4 BSP	A129020	13,60
1"1/2 BSP	A129024	12,95
2" BSP	A129032	12,95

### Racor macho BSP (60°) soldable interior



Mamelon BSP hexagone à souder intérieur sw (60°)

Welding adaptor BSP male (60°) (internal welding)

Raccordo maschio BSP a saldare di tasca

ROSCA THREAD	REFERENCIA PART N°	€
1/8" BSP	A103102	1,72
1/4" BSP	A103104	0,89
3/8" BSP	A103106	1,05
1/2" BSP	A103108	1,86
3/4" BSP	A103112	4,36
1" BSP	A103116	5,48
1"1/4 BSP	A103120	12,34
1"1/2 BSP	A103124	16,62
2" BSP	A103132	21,69

### Racor macho BSP (60°) soldable exterior

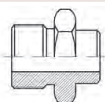

Mamelon BSP hexagone à souder extérieur bw (60°)

Welding adaptor BSP male (60°) (external welding)

Raccordo maschio BSP a saldare

ROSCA THREAD	REFERENCIA PART N°	€
1/8" BSP	A103002	2,01
1/4" BSP	A103004	0,94
3/8" BSP	A103006	1,22
1/2" BSP	A103008	1,60
3/4" BSP	A103012	2,64
1" BSP	A103016	3,95
1"1/4 BSP	A103020	9,22
1"1/2 BSP	A103024	11,48
2" BSP	A103032	17,59

### Esférico BSP soldable exterior

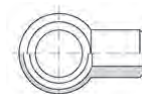

Banjo passage gaz à souder (bw)

BSP Banjo external welding

Raccordo a occhio BSP a saldare

ROSCA THREAD	Ø	REFERENCIA PART N°	€
1/8" BSP	1/8"	A114102	1,16
1/4" BSP	1/4"	A114104	1,80
3/8" BSP	3/8"	A114106	2,78
1/2" BSP	1/2"	A114108	4,64
3/4" BSP	3/4"	A114112	5,27
1" BSP	1"	A114116	31,49

### Soldables para cilindros



Raccords à souder pour verins

Welding nipples for cylinders

Borchia a saldare femmina-femmina

ROSCA THREAD	REFERENCIA PART N°	€
1/4" BSP	A1311040000	1,09
3/8" BSP	A1311060000	1,13
1/2" BSP	A1311080000	1,33
3/4" BSP	A1311120000	2,61

## Adaptadores BSP

Adapteurs BSP  
BSP Adaptors  
Adattatori BSP

Adaptors

ORFS

Quick-release couplings

Ball valves, diverters

Protections

### Codo tubo 90° macho-hembra giratoria BSP (60°)



Adapteur coude 90° tube mâle BSP x femelle tournante BSP (60°)  
90° Elbow tube BSP female-male  
Curva 90° maschio-femmina girevole BSP 60°

ROSCA THREAD		REFERENCIA PART N°	€
1/4" BSP	1/4" BSP	A119404	4,43
3/8" BSP	3/8" BSP	A119406	6,45
1/2" BSP	1/2" BSP	A119408	7,90
3/4" BSP	3/4" BSP	A119412	12,95
1" BSP	1" BSP	A119416	22,25
1"1/4 BSP	1"1/4 BSP	A119420	52,26
1"1/2 BSP	1"1/2 BSP	A119424	75,46
2" BSP	2" BSP	A119432	145,75

### Codo tubo 90° hembra giratoria-hembra giratoria BSP (60°)

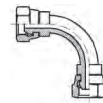

Adapteur coude 90° tube femelle tournante BSP x femelle tournante BSP (60°)  
90° Elbow tube BSP swivel female-BSP swivel female  
Curva 90° femmina-femmina girevole BSP 60°

ROSCA THREAD		REFERENCIA PART N°	€
1/4" BSP	1/4" BSP	A119604	5,95
3/8" BSP	3/8" BSP	A119606	6,82
1/2" BSP	1/2" BSP	A119608	8,57
3/4" BSP	3/4" BSP	A119612	13,32
1" BSP	1" BSP	A119616	23,41

### Codo tubo 45° macho-hembra giratoria BSP (60°)



Adapteur coude 45° tube mâle BSP x femelle tournante BSP (60°)  
45° Elbow tube BSP female-male  
Curva 45° maschio-femmina girevole BSP 60°

ROSCA THREAD		REFERENCIA PART N°	€
1/4" BSP	1/4" BSP	A119504	4,69
3/8" BSP	3/8" BSP	A119506	6,83
1/2" BSP	1/2" BSP	A119508	8,35
3/4" BSP	3/4" BSP	A119512	14,41
1" BSP	1" BSP	A119516	20,93

### Codo 90° macho-macho BSP (60°) forja

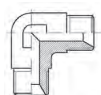

Adapteur coude 90° mâle BSP x mâle BSP (60°) forge  
90° Elbow BSP male (60°)-BSP male (60°) forge  
Adattatore a 90° maschio-maschio BSP (60°) forgiato

ROSCA THREAD		REFERENCIA PART N°	€
1/4" BSP	1/4" BSP	S119004	2,41
3/8" BSP	3/8" BSP	S119006	2,86
1/2" BSP	1/2" BSP	S119008	3,67
3/4" BSP	3/4" BSP	S119012	5,72
1" BSP	1" BSP	S119016	11,67
1"1/4 BSP	1"1/4 BSP	S119020	31,94

### Codo 90° macho BSP (60°) -macho BSPT forja



Adapteur coude 90° mâle BSP x mâle gaz conique (BSPT) (60°) forge  
90° Elbow BSP male (60°)-BSPT male forge  
Adattatore a 90° maschio BSP (60°) - maschio BSPT forgiato

ROSCA THREAD		REFERENCIA PART N°	€
1/8" BSP	1/8" BSPT	S119202	1,90
1/4" BSP	1/4" BSPT	S119204	2,28
3/8" BSP	3/8" BSPT	S119206	3,16
1/2" BSP	1/2" BSPT	S119208	4,06
3/4" BSP	3/4" BSPT	S119212	6,10
1" BSP	1" BSPT	S119216	14,68

### Codo 90° macho-macho BSPT forja

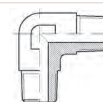

Adapteur coude 90° mâle gaz conique (BSPT) x mâle gaz conique (BSPT) forge  
90° Elbow BSPT male-BSPT male forge  
Adattatore a 90° maschio-maschio BSPT forgiato

ROSCA THREAD		REFERENCIA PART N°	€
1/4" BSPT	1/4" BSPT	S119504	5,98
3/8" BSPT	3/8" BSPT	S119506	7,44
1/2" BSPT	1/2" BSPT	S119508	11,64
3/4" BSPT	3/4" BSPT	S119512	13,96
1" BSPT	1" BSPT	S119516	26,69

## Adaptadores BSP

Adapteurs BSP  
BSP Adaptors  
Adattatori BSP

### Codo 90° macho BSP (60°) -macho BSP regulable forja



Adapteur coude 90° mâle BSP x mâle gaz cyl orientable or + bae en forge  
90° Elbow BSP male-BSP male adjustable forge  
Adattatore a 90° maschio BSP 60° - maschio BSP regolabile forgiato

ROSCA THREAD		REFERENCIA PART N°	€
M 1/4" BSP	MR 1/4" BSP	S11970404	3,46
M 3/8" BSP	MR 1/4" BSP	S11970604	5,11
M 3/8" BSP	MR 3/8" BSP	S11970606	4,59
M 1/2" BSP	MR 3/8" BSP	S11970806	5,28
M 1/2" BSP	MR 1/2" BSP	S11970808	6,15
M 3/4" BSP	MR 1/2" BSP	S11971208	10,73
M 3/4" BSP	MR 3/4" BSP	S11971212	11,15
M 1" BSP	MR 3/4" BSP	S11971612	18,26
M 1" BSP	MR 1" BSP	S11971616	14,38
M 1 1/4" BSP	MR 1 1/4" BSP	S11972020	28,39

### Codo 45° macho BSP (60°) -macho BSP regulable forja



Adapteur coude 45° mâle BSP x mâle gaz cyl orientable or + bae en forge  
45° Elbow BSP male-BSP male adjustable forge  
Adattatore a 45° maschio BSP 60° - maschio BSP regolabile forgiato

ROSCA THREAD		REFERENCIA PART N°	€
M 1/4" BSP	MR 1/4" BSP	S11980404	3,72
M 3/8" BSP	MR 3/8" BSP	S11980606	5,70
M 1/2" BSP	MR 1/2" BSP	S11980808	8,22
M 3/4" BSP	MR 3/4" BSP	S11981212	9,35
M 1" BSP	MR 1" BSP	S11981616	16,97

### Codo 90° macho-hembra giratoria BSP (60°) forja

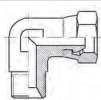

Adapteur coude 90° mâle BSP x femelle tournante BSP (60°) forge  
90° Elbow BSP male-BSP swivel female forge  
Adattatore a 90° maschio-femmina girevole BSP (60°) forgiato

ROSCA THREAD		REFERENCIA PART N°	€
1/4" BSP	1/4" BSP	S119304	3,46
3/8" BSP	3/8" BSP	S119306	4,74
1/2" BSP	1/2" BSP	S119308	5,95
3/4" BSP	3/4" BSP	S119312	8,49
1" BSP	1" BSP	S119316	13,77
1 1/4" BSP	1 1/4" BSP	S119320	22,16
1 1/2" BSP	1 1/2" BSP	S119324	46,22

### Codo 90° macho BSPT- hembra giratoria BSP (60°) forja

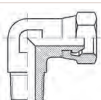

Adapteur coude 90° mâle gaz conique (BSPT) x femelle tournante BSP (60°) forge  
90° Elbow BSPT male-BSP swivel female (60°) forge  
Adattatore a 90° maschio BSPT - femmina girevole BSP 60° forgiato

ROSCA THREAD		REFERENCIA PART N°	€
M 1/4" BSPT	H 1/4" BSP	S119904	8,09
M 3/8" BSPT	H 3/8" BSP	S119906	10,18
M 1/2" BSPT	H 1/2" BSP	S119908	13,54
M 3/4" BSPT	H 3/4" BSP	S119912	19,91
M 1" BSPT	H 1" BSP	S119916	32,29

### Codo 90° macho BSPT- hembra fija BSP forja



Adapteur coude 90° mâle gaz conique (BSPT) x femelle gaz conique (BSP) forge  
90° Elbow BSPT male-BSP fixed female forge  
Adattatore a 90° maschio BSPT - femmina fissa BSP (60°) forgiato

ROSCA THREAD		REFERENCIA PART N°	€
M 1/8" BSPT	H 1/8" BSP	S119402	2,92
M 1/4" BSPT	H 1/4" BSP	S119404	4,00
M 3/8" BSPT	H 3/8" BSP	S119406	4,33
M 1/2" BSPT	H 1/2" BSP	S119408	5,28
M 3/4" BSPT	H 3/4" BSP	S119412	9,76
M 1" BSPT	H 1" BSP	S119416	13,55

### Codo 90° hembra fija- hembra fija BSP forja

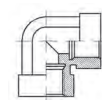

Adapteur coude 90° femelle fixe gaz cyl forge  
90° Elbow BSP fixed female-BSP fixed female forge  
Adattatore a 90° maschio BSPT - femmina fissa BSP forgiato

ROSCA THREAD		REFERENCIA PART N°	€
1/8" BSP	1/8" BSP	S119602	3,12
1/4" BSP	1/4" BSP	S119604	3,69
3/8" BSP	3/8" BSP	S119606	4,59
1/2" BSP	1/2" BSP	S119608	7,15
3/4" BSP	3/4" BSP	S119612	10,76
1" BSP	1" BSP	S119616	16,18
1 1/4" BSP	1 1/4" BSP	S119620	48,21

### Codo 45° macho-hembra giratoria forja BSP 60° forja

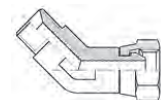

Adapteur coude 45° mâle-femelle tournante BSP forge  
45° Elbow BSP male-BSP swivel female forge  
Adattatore a 45° maschio-femmina girevole BSP forgiato

ROSCA THREAD		REFERENCIA PART N°	€
1/4" BSP	1/4" BSP	S118504	3,38
3/8" BSP	3/8" BSP	S118506	4,07
1/2" BSP	1/2" BSP	S118508	5,63
3/4" BSP	3/4" BSP	S118512	8,48
1" BSP	1" BSP	S118516	13,07
1 1/4" BSP	1 1/4" BSP	S118520	23,80

### Codo 90° macho-macho Métrico (60°) forja



Adapteur coude 90° mâle Métrique x mâle Métrique (60°) forge  
90° Elbow Metric adaptor male-male (60°)  
Adattatore a 90° maschio-maschio Metrico

ROSCA THREAD		REFERENCIA PART N°	€
M12x1.5	M12x1.5	S86012	5,43
M16x1.5	M16x1.5	S86016	6,69
M22x1.5	M22x1.5	S86022	13,48

## Adaptadores BSP

Adapteurs BSP  
BSP Adaptors  
Adattatori BSP

### Codo 90° hembra giratoria-hembra giratoria BSP (60°) forja



Adapteur coude 90° femelle tournante BSP x femelle tournante BSP (60°) forge  
90° Elbow BSP swivel female-BSP swivel female forge  
Adattatore a 90° femmina girevole BSP (60°)-femmina girevole BSP (60°) forgiato

ROSCA THREAD		REFERENCIA PART N°	€
1/4" BSP	1/4" BSP	S118304	8,11
3/8" BSP	3/8" BSP	S118306	11,33
1/2" BSP	1/2" BSP	S118308	12,29
3/4" BSP	3/4" BSP	S118312	14,70
1" BSP	1" BSP	S118316	22,53
1" 1/4 BSP	1" 1/4 BSP	S118320	40,81
1" 1/2 BSP	1" 1/2 BSP	S118324	46,58

### Codo 45° orientable macho-hembra giratoria BSP (60°) forja

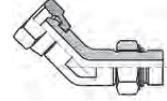

Adapteur coude 45° orientable mâle-femelle tournante (60°)  
45° Elbow male-swivel female - adjustable forge  
Adattatore a 45° orientabile maschio-femmina girevole BSP forgiato

ROSCA THREAD		REFERENCIA PART N°	€
1/4" BSP	1/4" BSP	S119104	10,66
3/8" BSP	3/8" BSP	S119106	14,30
1/2" BSP	1/2" BSP	S119108	14,87
3/4" BSP	3/4" BSP	S119112	20,72
1" BSP	1" BSP	S119116	30,64

### Te macho-macho-macho BSP forja

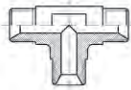

Adapteur Té mâle BSP x mâle BSP x mâle BSP (60°) forge  
Tee BSP Male (60°) forge  
Adattatore a T maschio BSP (60°) forgiato

ROSCA THREAD			REFERENCIA PART N°	€
1/4" BSP	1/4" BSP	1/4" BSP	S122004	3,01
3/8" BSP	3/8" BSP	3/8" BSP	S122006	3,85
1/2" BSP	1/2" BSP	1/2" BSP	S122008	5,65
3/4" BSP	3/4" BSP	3/4" BSP	S122012	7,30
1" BSP	1" BSP	1" BSP	S122016	13,40
1"1/4 BSP	1"1/4 BSP	1"1/4 BSP	S122020	39,99

### Te macho-hembra giratoria-macho BSP (60°) forja

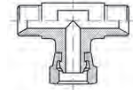

Adapteur Té mâle BSP x femelle tournante BSP x mâle BSP (60°) forge  
Tee BSP Male-swivel female-male (60°) forge  
Adattatore a T maschio-femmina girevole-maschio BSP forgiato

ROSCA THREAD			REFERENCIA PART N°	€
1/4" BSP	1/4" BSP	1/4" BSP	S122404	3,69
3/8" BSP	3/8" BSP	3/8" BSP	S122406	4,74
1/2" BSP	1/2" BSP	1/2" BSP	S122408	6,77
3/4" BSP	3/4" BSP	3/4" BSP	S122412	10,99
1" BSP	1" BSP	1" BSP	S122416	17,09
1"1/4 BSP	1"1/4 BSP	1"1/4 BSP	S122420	27,35

### Te hembras giratorias BSP (60°) forja

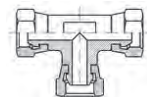

Adapteur Té femelle tournante BSP (60°) forge  
Tee BSP Swivel female (60°) forge  
Adattatore a T femmina girevole BSP forgiato

ROSCA THREAD			REFERENCIA PART N°	€
1/4" BSP	1/4" BSP	1/4" BSP	S122504	7,27
3/8" BSP	3/8" BSP	3/8" BSP	S122506	8,57
1/2" BSP	1/2" BSP	1/2" BSP	S122508	9,95
3/4" BSP	3/4" BSP	3/4" BSP	S122512	17,49
1" BSP	1" BSP	1" BSP	S122516	28,65

### Te macho-macho-hembra giratoria BSP (60°) forja

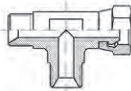

Adapteur Té mâle BSP x mâle BSP x femelle tournante BSP (60°) forge  
Tee BSP Male-male-swivel female (60°) forge  
Adattatore a T maschio-maschio-femmine girevole BSP forgiato

ROSCA THREAD			REFERENCIA PART N°	€
1/4" BSP	1/4" BSP	1/4" BSP	S122304	3,56
3/8" BSP	3/8" BSP	3/8" BSP	S122306	4,57
1/2" BSP	1/2" BSP	1/2" BSP	S122308	6,77
3/4" BSP	3/4" BSP	3/4" BSP	S122312	11,47
1" BSP	1" BSP	1" BSP	S122316	17,09
1"1/4 BSP	1"1/4 BSP	1"1/4 BSP	S122320	26,23

## Adaptadores BSP

Adapteurs BSP  
BSP Adaptors  
Adattatori BSP

### Te hembras fijas BSP forja

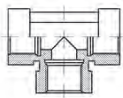

Adapteur Té femelle fixe gaz (BSP) forge

Tee BSP fixed female forge

Adattatore a T femmina fissa BSP

ROSCA THREAD			REFERENCIA PART N°	€
1/8" BSP	1/8" BSP	1/8" BSP	S122602	3,81
1/4" BSP	1/4" BSP	1/4" BSP	S122604	4,59
3/8" BSP	3/8" BSP	3/8" BSP	S122606	6,25
1/2" BSP	1/2" BSP	1/2" BSP	S122608	7,51
3/4" BSP	3/4" BSP	3/4" BSP	S122612	13,43
1" BSP	1" BSP	1" BSP	S122616	23,78
1"1/4 BSP	1"1/4 BSP	1"1/4 BSP	S122620	79,89

### Te macho-macho-macho regulable lateral BSP forja

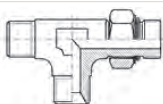

Adapteur Té égal orientable latéral mâle BSP (60°) x mâle BSP (60°) x mâle gaz cyl + o'ring forge

Tee BSP male-male-male lateral adjustable forge

Adattatore a T maschio-maschio-maschio orientabile laterale BSP

ROSCA THREAD			REFERENCIA PART N°	€
1/4" BSP	1/4" BSP	MR 1/4" BSP	S12290404	12,81
3/8" BSP	3/8" BSP	MR 3/8" BSP	S12290606	18,62
1/2" BSP	1/2" BSP	MR 3/8" BSP	S12290806	26,66
1/2" BSP	1/2" BSP	MR 1/2" BSP	S12290808	26,66
3/4" BSP	3/4" BSP	MR 1/2" BSP	S12291208	37,44
3/4" BSP	3/4" BSP	MR 3/4" BSP	S12291212	36,49
1" BSP	1" BSP	MR 3/4" BSP	S12291612	49,65
1" BSP	1" BSP	MR 1" BSP	S12291616	49,65
1"1/4 BSP	1"1/4 BSP	MR 1"1/4 BSP	S12292020	65,13

### Codo 90° reductor macho-macho cuadrado BSP (60°)



Adapteur coude 90° reducteur mâle BSP x mâle BSP (60°) en bloque

90° reducer elbow male-bsp male (60°) (square)

Adattatore a 90° maschio-maschio quadrato BSP (60°)

ROSCA THREAD		REFERENCIA PART N°	€
1/8" BSP	1/4" BSP	A11920204	5,07
1/4" BSP	3/8" BSP	A11920406	6,25
3/8" BSP	1/2" BSP	A11920608	9,18
1/2" BSP	3/4" BSP	A11920812	12,55
3/4" BSP	1" BSP	A11921216	29,40

### Te macho-macho regulable central-macho BSP forja

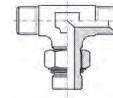

Adapteur Té égal orientable central mâle BSP (60°) x mâle gaz cyl + o'ring x mâle BSP (60°) forge

Tee BSP male-male central adjustable-BSP male forge

Adattatore a T maschio-maschio-maschio orientabile centrale BSP forgiato

ROSCA THREAD			REFERENCIA PART N°	€
1/4" BSP	MR 1/4" BSP	1/4" BSP	S12280404	12,81
3/8" BSP	MR 1/4" BSP	3/8" BSP	S12280604	28,74
3/8" BSP	MR 3/8" BSP	3/8" BSP	S12280606	18,62
1/2" BSP	MR 3/8" BSP	1/2" BSP	S12280806	33,86
1/2" BSP	MR 1/2" BSP	1/2" BSP	S12280808	26,66
3/4" BSP	MR 3/4" BSP	1/2" BSP	S12281208	43,33
3/4" BSP	MR 3/4" BSP	3/4" BSP	S12281212	37,18
1" BSP	MR 3/4" BSP	1" BSP	S12281612	57,83
1" BSP	MR 1" BSP	1" BSP	S12281616	49,65
1"1/4 BSP	MR 1" BSP	1"1/4 BSP	S12282016	65,13
1"1/4 BSP	MR 1"1/4 BSP	1"1/4 BSP	S12282020	76,62

### Te macho-macho-macho Métrica (60°)

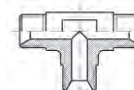

Adapteur Té égal mâle x mâle x mâle Métrique (60°)

Tee Metric male (60°)

Adattatore a T maschio-maschio-maschio Metrico

ROSCA THREAD			REFERENCIA PART N°	€
M16x1.5	M16x1.5	M16x1.5	S86516	10,75
M18x1.5	M18x1.5	M18x1.5	S86518	11,61
M20x1.5	M20x1.5	M20x1.5	S86520	14,04
M22x1.5	M22x1.5	M22x1.5	S86522	14,04
M26x1.5	M26x1.5	M26x1.5	S86526	22,94
M30x1.5	M30x1.5	M30x1.5	S86530	30,43

### Codo 90° macho BSP bloque

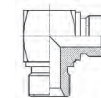

Adapteur Coude 90° mâle BSP

90° Elbow BSP male (square)

Adattatore a 90° maschio-maschio quadrato BSP (60°)

ROSCA THREAD		REFERENCIA PART N°	€
1/4" BSP	1/4" BSP	A21900400	3,09
3/8" BSP	3/8" BSP	A21900600	3,54
1/2" BSP	1/2" BSP	A21900800	5,12
3/4" BSP	3/4" BSP	A21901200	7,60
1" BSP	1" BSP	A21901600	14,72



## Adaptadores BSP

Adapteurs BSP  
BSP Adaptors  
Adattatori BSP

## Codo 90° macho-hembra giratoria bloque



Adapteur Coude 90° mâle BSP x femelle BSP

90° Elbow BSP male-BSP swivel female (square)

Adattatore a 90° maschio-femmina girevole quadrato BSP (60°)

ROSCA THREAD		REFERENCIA PART N°	€
1/4" BSP	1/4" BSP	A21930400	4,22
3/8" BSP	3/8" BSP	A21930600	4,46
1/2" BSP	1/2" BSP	A21930800	7,15
3/4" BSP	3/4" BSP	A21931200	8,66
1" BSP	1" BSP	A21931600	28,65

## Te macho-macho-macho bloque

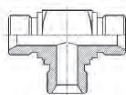

Adapteur Té mâle BSP x mâle BSP x mâle BSP

Tee BSP male (square)

Adattatore a T maschio quadrato BSP 60°

ROSCA THREAD			REFERENCIA PART N°	€
1/4" BSP	1/4" BSP	1/4" BSP	A22200400	4,16
3/8" BSP	3/8" BSP	3/8" BSP	A22200600	5,22
1/2" BSP	1/2" BSP	1/2" BSP	A22200800	7,23
3/4" BSP	3/4" BSP	3/4" BSP	A22201200	10,39
1" BSP	1" BSP	1" BSP	A22201600	22,85

## Te macho-tuerca loca-macho bloque

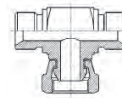

Adapteur Té mâle BSP x femelle tournante BSP x mâle BSP

Tee BSP male-swivel female-male (square)

Adattatore a T maschio-femmina girevole-maschio quadrato BSP (60°)

ROSCA THREAD			REFERENCIA PART N°	€
1/4" BSP	1/4" BSP	1/4" BSP	A22240400	4,33
3/8" BSP	3/8" BSP	3/8" BSP	A22240600	5,72
1/2" BSP	1/2" BSP	1/2" BSP	A22240800	8,05
3/4" BSP	3/4" BSP	3/4" BSP	A22241200	11,07
1" BSP	1" BSP	1" BSP	A22241600	21,21

## Te macho-macho-tuerca loca bloque

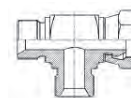

Adapteur Té mâle BSP x mâle BSP x femelle tournante BSP

Tee BSP male-male-swivel female (square)

Adattatore a T maschio-maschio-femmina girevole quadrato BSP

ROSCA THREAD			REFERENCIA PART N°	€
1/4" BSP	1/4" BSP	1/4" BSP	A22220400	4,14
3/8" BSP	3/8" BSP	3/8" BSP	A22220600	5,65
1/2" BSP	1/2" BSP	1/2" BSP	A22220800	7,90
3/4" BSP	3/4" BSP	3/4" BSP	A22221200	17,01
1" BSP	1" BSP	1" BSP	A22221600	21,21

## Cruz macho BSP bloque

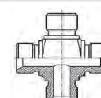

Adapteur Croix égale mâle BSP

Cross BSP male (square)

Croce maschio BSP 60°

ROSCA THREAD	REFERENCIA PART N°	€
1/4" BSP	A22230400	4,83
3/8" BSP	A22230600	4,45
1/2" BSP	A22230800	8,58
3/4" BSP	A22231200	15,43
1" BSP	A22231600	15,94

## Adaptadores BSP

Adaptateurs BSP  
BSP Adaptors  
Adattatori BSP

### Juntas Metal Buna GAS Autocentrantes

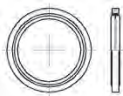

Bague BS Gaz  
BSP Bonded Seal  
Rondelle Bonded GAS

ROSCA THREAD	REFERENCIA PART N°	€
1/8" BSP	T21002	0,18
1/4" BSP	T21004	0,18
3/8" BSP	T21006	0,24
1/2" BSP	T21008	0,29
5/8" BSP	T21010	0,57
3/4" BSP	T21012	0,38
1" BSP	T21016	0,64
1"1/4 BSP	T21020	0,96
1"1/2 BSP	T21024	1,18
2" BSP	T21032	1,77

Se venden en bolsas, consultar cantidades // Vendu dans des sacs, demandez la quantité // Sold in bags, ask for quantity // Venduti in sacchetti, chiedere per la quantità

### Juntas Metal Buna Métricas Autocentrantes

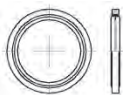

Bague BS Métrique  
Metric Bonded Seal  
Rondelle Bonded Metricha

ROSCA THREAD	REFERENCIA PART N°	€
M8x1	T32008	0,24
M10x1	T32010	0,24
M12x1.5	T32012	0,25
M14x1.5	T32014	0,27
M16x1.5	T32016	0,29
M18x1.5	T32018	0,32
M20x1.5	T32020	0,33
M22x1.5	T32022	0,35
M24x1.5	T32024	0,41
M26x1.5	T32026	0,59
M30x2	T32030	0,65
M32x2	T32032	0,94
M36x2	T32036	1,22
M42x2	T32042	2,51

Se venden en bolsas, consultar cantidades // Vendu dans des sacs, demandez la quantité // Sold in bags, ask for quantity // Venduti in sacchetti, chiedere per la quantità

### Arandelas Aluminio GAS



Rondelle Gaz Aluminium  
BSP Aluminium Collar Plate  
Rondella in Alluminio GAS

ROSCA THREAD	REFERENCIA PART N°	€
1/8"	A133202	0,13
1/4"	A133204	0,18
3/8"	A133206	0,23
1/2"	A133208	0,36
3/4"	A133212	0,55
1"	A133216	0,73
1"1/4	A133220	1,10
1"1/2	A133224	0,83

### Arandelas plana Cobre recocido GAS



Rondelle plane Gaz Cuivre recuit  
Annealed Copper flat Plate  
Rondella in Rame

ROSCA THREAD	REFERENCIA PART N°	€
1/8"	A133002	0,19
1/4"	A133004	0,30
3/8"	A133006	0,32
1/2"	A133008	0,48
3/4"	A133012	0,89
1"	A133016	1,02
1"1/4	A133020	2,10
1"1/2	A133024	2,55
2"	A133032	3,82

## Artículos bajo consulta

Articles à consulter | Items on request | Articoli su richiesta

Adaptors

### S1180

**Codo 45° macho-macho BSP (60°) forja** | Adapteur coude 45° mâle BSP (60°)x mâle BSP (60°) forge | 45° elbow male bsp-male bsp (60°) forge | Adattatore a 45° maschio-maschio BSP (60°) forgiato

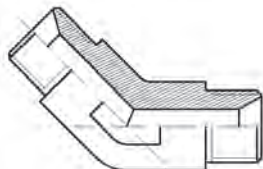

### S1182

**Codo 45° macho BSP (60°) -macho BSPT forja** | Adapteur coude 45° mâle BSP (60°)x mâle BSPT forge | 45° Elbow BSP male (60°)-BSPT male forge | Adattatore a 45° maschio BSP (60°) - maschio BSPT forgiato

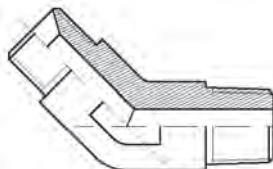

### S1183

**Codo 90° hembra giratoria-hembra giratoria BSP (60°) forja** | Adapteur coude 90° femelle tournante BSP (60°) forge | 90° Elbow BSP (60°) swivel female-BSP (60°) swivel female forge | Adattatore a 90° femmina girevole-femmina girevole BSP (60°) forgiato

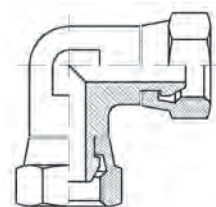

ORFS

### S1184

**Codo 90° macho BSPT-hembra giratoria BSP (60°) forja** | Adapteur coude 90° mâle BSPT x femelle tournante BSP (60°) forge | 90° Elbow BSPT male-BSP (60°) swivel female forge | Adattatore a 90° maschio BSPT-femmina girevole BSP (60°) forgiato

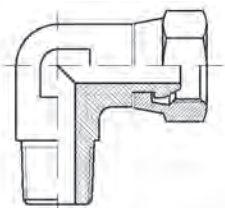

### S1186

**Codo 45° hembra fija-hembra fija BSP (60°) forja** | Adapteur coude 45° femelle fixe BSP (60°) forge | 45° Elbow BSP (60°) fixed female-BSP (60°) fixed female forge | Adattatore a 45° femmina fissa-femmina fissa BSP (60°) forgiato

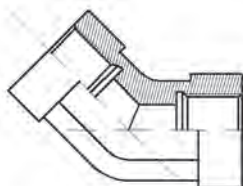

### S1281

**Te macho BSP (60°)-macho BSPT-macho BSP (60°) forja** | Adapteur Té mâle BSP (60°)x mâle BSPT x mâle BSP (60°) forge | Tee BSP (60°) male-BSPT male-BSP (60°) male forge | Adattatore a T maschio BSP (60°)-maschio BSPT-maschio BSP (60°) forgiato

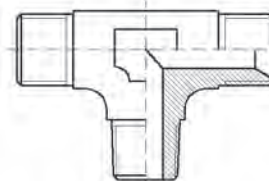

Ball valves, diverters

### S1282

**Te macho BSP (60°)-macho BSP (60°)-macho BSPT forja** | Adapteur Té mâle BSP (60°) x mâle BSP (60°) x mâle BSPT forge | Tee BSP male (60°)-BSP male (60°)-BSPT male forge | Adattatore a T maschio BSP (60°)-maschio BSP (60°)-maschio BSPT forgiato

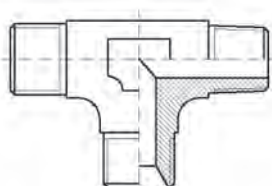

Protections

Quick-release couplings

Gama de productos. Para más información soliciten nuestros catálogos generales o visiten nuestra página web  
Gamme de produits. Pour plus d'information, nous vous prions de nous demander nos catalogues generaux ou visiter notre web-site  
Products range. For any further information, please, ask for our general catalogues or visit our web-site  
Gamma di Prodotti. Per ulteriori información di ricuidete il nostri cataloghi o visitate la Nostra pagina web

**PAVIMENTOS DE GOMA**  
PAVEMENTS  
FLOOR MATTINGS  
PAVIMENTI DI GOMMA

**PLANCHAS DE GOMA**  
PLANCHES DE GOMME  
RUBBER SHEETS  
LASTRE DI GOMMA



**SILICONAS**  
SILICONE  
SILICONE  
SILICONE

**ALFOMBRAS**  
TAPIS  
MATS  
TAPPETI

# Accesorios ORFS

Accessoires ORFS  
ORFS Accessories  
Accessori ORFS

# 2

Accesorios ORFS  
Accessoires ORFS | ORFS | ORFS

256

# Accesorios ORFS

Accessoires ORFS | ORFS | ORFS

Adaptors

ORFS

Quick-release couplings

Ball valves, diverters

Protections

## ▶ **ORFS Rectos** | ORFS Droits | Straight ORFS | Raccordi diritti ORFS

257

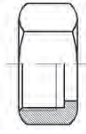

OR102



OR104

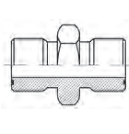

OR200

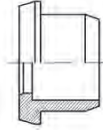

OR1273

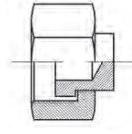

OR105



OR202



OR302

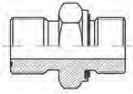

OR1017

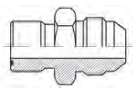

OR204

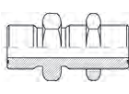

OR106

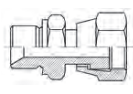

OR303

## ▶ **Codos 45° ORFS** | Coude 45° ORFS | ORFS 45° Elbows | Raccordi a 45° ORFS

259

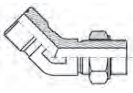

OR501

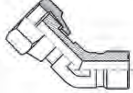

OR601

## ▶ **Codos 90° ORFS** | Coude 90° ORFS | ORFS 90° Elbows | Raccordi a 90° ORFS

259

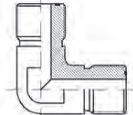

OR405



OR600

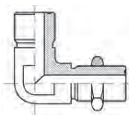

OR403

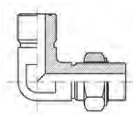

OR401

## ▶ **Te ORFS** | Tés ORFS | ORFS Tees | Raccordi a T ORFS

260

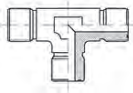

OR700



OR701

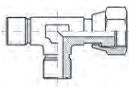

OR702

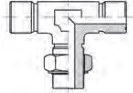

OR703

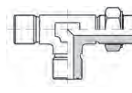

OR704

# Accesorios ORFS

Accessoires ORFS  
ORFS  
ORFS

## Tuerca ORFS

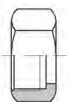

Ecrou ORFS  
ORFS Nut  
Dado ORFS

TUBO PIPE	ROSCA THREAD	REFERENCIA PART N°	€
6-8	ORFS 9/16"-18h	OR1020400	0,83
10	ORFS 11/16"-16h	OR1020600	1,03
12	ORFS 13/16"-16h	OR1020800	1,20
14-15-16	ORFS 1"-14h	OR1021000	1,62
18-20	ORFS 1"3/16-12h	OR1021200	4,41
22-25	ORFS 1"7/16-12h	OR1021600	4,83
28-30-32	ORFS 1"11/16-12h	OR1022000	8,96
35-38	ORFS 2"-12h	OR1022400	10,46

## Cono soldar

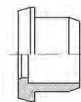

Collet à souder ORFS  
ORFS Welding cone  
Ogiva a saldare ORFS

TUBO PIPE	ROSCA THREAD	REFERENCIA PART N°	€
6	ORFS 9/16"-18h	OR12730406	1,38
10	ORFS 11/16"-16h	OR12730610	1,51
12	ORFS 13/16"-16h	OR12730812	1,61
14	ORFS 1"-14h	OR12731014	2,03
15	ORFS 1"-14h	OR12731015	2,03
16	ORFS 1"-14h	OR12731016	2,03
18	ORFS 1" 3/16-12h	OR12731218	2,24
20	ORFS 1" 3/16-12h	OR12731220	2,24
30	ORFS 1"11/16-12h	OR12732030	7,15
32	ORFS 1"11/16-12h	OR12732032	7,15
38	ORFS 2"-12h	OR12732438	8,09

## Tapón macho ORFS



Bouchon mâle ORFS  
ORFS Male plug  
Tappo maschio ORFS

ROSCA THREAD	REFERENCIA PART N°	€
ORFS 9/16"-18h	OR1040400	1,41
ORFS 11/16"-16h	OR1040600	1,53
ORFS 13/16"-16h	OR1040800	1,89
ORFS 1"-14h	OR1041000	2,40
ORFS 1"3/16-12h	OR1041200	3,49
ORFS 1"7/16-12h	OR1041600	5,98
ORFS 1"11/16-12h	OR1042000	8,31
ORFS 2"-12h	OR1042400	16,28

## Tapón hembra ORFS

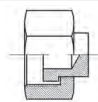

Bouchon femelle ORFS  
ORFS Female plug  
Tappo femmina ORFS

ROSCA THREAD	REFERENCIA PART N°	€
ORFS 9/16"-18h	OR1050400	1,50
ORFS 11/16"-16h	OR1050600	1,99
ORFS 13/16"-16h	OR1050800	2,62
ORFS 1"-14h	OR1051000	3,57
ORFS 1"3/16-12h	OR1051200	5,24
ORFS 1"7/16-12h	OR1051600	6,31
ORFS 1"11/16-12h	OR1052000	13,62
ORFS 2"-12h	OR1052400	16,40

## Adaptador macho ORFS

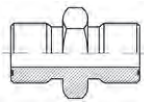

Mâle ORFS-ORFS  
ORFS-ORFS Male  
Adattatore maschio ORFS

ROSCA THREAD	ROSCA THREAD	REFERENCIA PART N°	€
ORFS 9/16"-18h	ORFS 9/16"-18h	OR2000404	2,33
ORFS 11/16"-16h	ORFS 9/16"-18h	OR2000604	2,38
ORFS 11/16"-16h	ORFS 11/16"-16h	OR2000606	2,91
ORFS 13/16"-16h	ORFS 11/16"-16h	OR2000806	3,57
ORFS 13/16"-16h	ORFS 13/16"-16h	OR2000808	3,57
ORFS 1"-14h	ORFS 13/16"-16h	OR2001008	4,48
ORFS 1"-14h	ORFS 1"-14h	OR2001010	4,48
ORFS 1" 3/16-12h	ORFS 1"-14h	OR2001210	5,23
ORFS 1"3/16-12h	ORFS 1"3/16-12h	OR2001212	10,66
ORFS 1"7/16-12h	ORFS 1"3/16-12h	OR2001612	24,30
ORFS 1"7/16-12h	ORFS 1"7/16-12h	OR2001616	12,79
ORFS 1"11/16-12h	ORFS 1"7/16-12h	OR2002016	22,35
ORFS 1"11/16-12h	ORFS 1"11/16-12h	OR2002020	22,01
ORFS 2"-12h	ORFS 2"-12h	OR2002424	25,67

## Adaptador macho ORFS-BSP

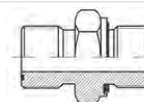

Mâle ORFS-BSP  
ORFS-BSP Male  
Adattatore maschio ORFS-BSP

ROSCA THREAD	ROSCA THREAD	REFERENCIA PART N°	€
ORFS 9/16"-18h	ORFS 9/16"	OR2020402	2,11
ORFS 9/16"-18h	BSP 1/4"	OR2020404	2,26
ORFS 11/16"-16h	BSP 1/4"	OR2020604	2,49
ORFS 11/16"-16h	BSP 3/8"	OR2020606	2,66
ORFS 13/16"-16h	BSP 3/8"	OR2020806	3,59
ORFS 13/16"-16h	BSP 1/2"	OR2020808	4,97
ORFS 1"-14h	BSP 1/2"	OR2021008	4,98
ORFS 1"3/16-12h	BSP 3/4"	OR2021212	5,23
ORFS 1"7/16-12h	BSP 1"	OR2021616	10,47
ORFS 1"11/16-12h	BSP 1" 1/4	OR2022020	27,01
ORFS 2"-12h	BSP 1" 1/2	OR2022424	34,11



## Accesorios ORFS

Accessoires ORFS  
ORFS  
ORFS

Adaptors

### Adaptador macho ORFS-hembra giratoria JIC

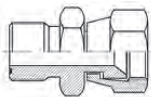

Mâle ORFS-femelle tournante JIC  
ORFS Male-JIC Swivel female  
Adattatore maschio ORFS-femmina girevole JIC

ROSCA THREAD		REFERENCIA PART N°	€
ORFS 9/16"-18h	JIC 7/16"	OR3020404	2,70
ORFS 11/16"-16h	JIC 9/16"	OR3020606	3,08
ORFS 13/16"-16h	JIC 3/4"	OR3020808	3,47
ORFS 1"-14h	JIC 7/8"	OR3021010	8,54
ORFS 1"3/16-12h	JIC 1" 1/16	OR3021212	4,68
ORFS 1"7/16-12h	JIC 1" 5/16	OR3021616	9,08
ORFS 1"11/16-12h	JIC 1" 5/8	OR3022020	16,83

### Pasatabiques ORFS

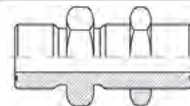

Passe-cloison ORFS  
ORFS Bulkhead  
Passaparete ORFS

ROSCA THREAD	REFERENCIA PART N°	€
ORFS 9/16"-18h	OR1060404	3,54
ORFS 11/16"-16h	OR1060606	5,85
ORFS 13/16"-16h	OR1060808	8,81
ORFS 1"-14h	OR1061010	9,17
ORFS 1"3/16-12h	OR1061212	15,53
ORFS 1"7/16-12h	OR1061616	16,89
ORFS 1"11/16-12h	OR1062020	82,39
ORFS 2"-12h	OR1062424	117,99

### Racor Recto M BSP - TL ORFS

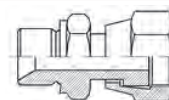

Mâle BSP-femelle tournante ORFS  
BSP male - ORFS swivel female  
Adattatore maschio BSP - femmina girevole ORFS

ROSCA THREAD		REFERENCIA PART N°	€
1/8" BSP	ORFS 9/16" 18h	OR3030402	12,26
1/4" BSP	ORFS 9/16" - 18h	OR3030404	10,37
1/4" BSP	ORFS 11/16" - 16h	OR3030604	11,18
3/8" BSP	ORFS 11/16" - 16h	OR3030606	11,56
3/8" BSP	ORFS 13/16" - 16h	OR3030806	12,42
1/2" BSP	ORFS 13/16" - 16h	OR3030808	15,88
1/2" BSP	ORFS 1" - 14h	OR3031008	15,17
3/4" BSP	ORFS 1"3/16 - 12h	OR3031212	20,03
1" BSP	ORFS 1"7/16 - 12h	OR3031616	32,78
1" 1/4 BSP	ORFS 1"11/16 - 12h	OR3032020	60,59
1" 1/2 BSP	ORFS 2" - 12h	OR3032424	81,65

### Macho ORFS-Métrico

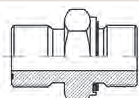

Mâle ORFS Métrique  
Metric ORFS Male  
Maschio ORFS Metrico

ROSCA THREAD		REFERENCIA PART N°	€
ORFS 9/16"-18h	M12x1.5	OR10170412	4,89
ORFS 11/16"-16h	M16x1.5	OR10170616	5,17
ORFS 13/16"-16h	M18x1.5	OR10170818	4,06
ORFS 1"-14h	M22x1.5	OR10171022	5,25
ORFS 1"7/16-12h	M33x2	OR10171633	10,87
ORFS 1"11/16-12h	M42x2	OR10172042	20,51
ORFS 2"-12h	M48x2	OR10172448	32,01

### Adaptador macho ORFS-JIC

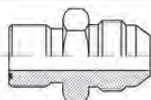

Mâle ORFS-JIC  
ORFS-JIC Male  
Adattatore maschio ORFS-JIC

ROSCA THREAD		REFERENCIA PART N°	€
ORFS 9/16"-18h	JIC 7/16"	OR2040404	2,08
ORFS 11/16"-16h	JIC 9/16"	OR2040606	2,24
ORFS 13/16"-16h	JIC 3/4"	OR2040808	2,74
ORFS 1"-14h	JIC 7/8"	OR2041010	3,99
ORFS 1"3/16-12h	JIC 1" 1/16	OR2041212	5,98
ORFS 1"7/16-12h	JIC 1" 5/16	OR2041616	9,14

Quick-release couplings

Ball valves, diverters

Protections

## Accesorios ORFS

Accessoires ORFS  
ORFS  
ORFS

### Codo 45° regulable ORFS-BSP

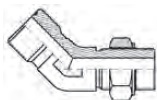

**Coude 45° mâle ORFS-mâle gaz cyl. +o'ring**  
**Adjustable 45° elbow ORFS male-BSP male**  
**Raccordo a 45° orientabile ORFS-BSP**

ROSCA THREAD		REFERENCIA PART N°	€
ORFS 9/16"-18h	BSP 1/8"	<b>OR5010402</b>	<b>5,15</b>
ORFS 9/16"-18h	BSP 1/4"	<b>OR5010404</b>	<b>5,40</b>
ORFS 11/16"-16h	BSP 1/4"	<b>OR5010604</b>	<b>6,15</b>
ORFS 11/16"-16h	BSP 3/8"	<b>OR5010606</b>	<b>6,90</b>
ORFS 11/16"-16h	BSP 1/2"	<b>OR5010608</b>	<b>8,22</b>
ORFS 13/16"-16h	BSP 3/8"	<b>OR5010806</b>	<b>9,30</b>
ORFS 1"-14h	BSP 1/2"	<b>OR5011008</b>	<b>11,38</b>
ORFS 1"-14h	BSP 3/4"	<b>OR5011012</b>	<b>14,54</b>
ORFS 1"3/16-12h	BSP 3/4"	<b>OR5011212</b>	<b>15,37</b>
ORFS 1"3/16-12h	BSP 1"	<b>OR5011216</b>	<b>22,26</b>
ORFS 1"7/16-12h	BSP 1"	<b>OR5011616</b>	<b>24,01</b>

### Codo 45° macho ORFS-hembra giratoria ORFS

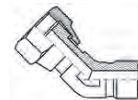

**Coude 45° mâle ORFS-femelle tournante ORFS**  
**45° elbow ORFS swivel female-ORFS male**  
**Raccordo a 45° maschio-femmina girevole ORFS**

ROSCA THREAD		REFERENCIA PART N°	€
ORFS 9/16"-18h	ORFS 9/16"-18h	<b>OR6010404</b>	<b>5,98</b>
ORFS 11/16"-16h	ORFS 11/16"-16h	<b>OR6010606</b>	<b>7,56</b>
ORFS 13/16"-16h	ORFS 13/16"-16h	<b>OR6010808</b>	<b>9,14</b>
ORFS 1"-14h	ORFS 1"-14h	<b>OR6011010</b>	<b>11,30</b>
ORFS 1"3/16-12h	ORFS 1"3/16-12h	<b>OR6011212</b>	<b>16,53</b>
ORFS 1"7/16-12h	ORFS 1"7/16-12h	<b>OR6011616</b>	<b>27,83</b>
ORFS 1" 11/16	ORFS 1" 11/16	<b>OR6012020</b>	<b>37,80</b>
ORFS 2"-12h	ORFS 2"-12h	<b>OR6012424</b>	<b>44,19</b>

### Codo 90° ORFS-ORFS



**Coude 90° mâle ORFS-mâle ORFS**  
**90° Elbow ORFS male-ORFS male**  
**Raccordo a 90° ORFS-ORFS**

ROSCA THREAD		REFERENCIA PART N°	€
ORFS 9/16"-18h	ORFS 9/16"-18h	<b>OR4050404</b>	<b>7,07</b>
ORFS 11/16"-16h	ORFS 11/16"-16h	<b>OR4050606</b>	<b>7,54</b>
ORFS 13/16"-16h	ORFS 13/16"-16h	<b>OR4050808</b>	<b>9,20</b>
ORFS 1"-14h	ORFS 1"-14h	<b>OR4051010</b>	<b>11,70</b>
ORFS 1"3/16-12h	ORFS 1"3/16-12h	<b>OR4051212</b>	<b>13,78</b>
ORFS 1"7/16-12h	ORFS 1"7/16-12h	<b>OR4051616</b>	<b>41,45</b>
ORFS 1"11/16-12h	ORFS 1"11/16-12h	<b>OR4052020</b>	<b>40,30</b>
ORFS 2"-12h	ORFS 2"-12h	<b>OR4052424</b>	<b>50,00</b>

### Codo 90° pasatabique ORFS

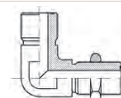

**Coude 90° passe-cloison ORFS**  
**90° Elbow ORFS Bulkhead**  
**Raccordo a 90° passaparete ORFS**

ROSCA THREAD		REFERENCIA PART N°	€
ORFS 9/16"-18h	ORFS 9/16"-18h	<b>OR4030404</b>	<b>13,21</b>
ORFS 11/16"-16h	ORFS 11/16"-16h	<b>OR4030606</b>	<b>18,15</b>
ORFS 1"-14h	ORFS 1"-14h	<b>OR4031010</b>	<b>23,45</b>
ORFS 1"3/16-12h	ORFS 1"3/16-12h	<b>OR4031212</b>	<b>28,97</b>
ORFS 1"7/16-12h	ORFS 1"7/16-12h	<b>OR4031616</b>	<b>50,62</b>
ORFS 1"11/16-12h	ORFS 1"11/16-12h	<b>OR4032020</b>	<b>58,50</b>
ORFS 2"-12h	ORFS 2"-12h	<b>OR4032424</b>	<b>79,04</b>

### Codo 90° regulable ORFS-BSP

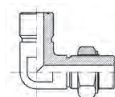

**Coude 90° mâle ORFS + mâle gaz cyl. +o'ring**  
**Adjustable 90° elbow ORFS male -BSP male**  
**Raccordo a 90° regolabile ORFS-BSP**

ROSCA THREAD		REFERENCIA PART N°	€
ORFS 9/16"-18h	BSP 1/8"	<b>OR4010402</b>	<b>9,52</b>
ORFS 9/16"-18h	BSP 1/4"	<b>OR4010404</b>	<b>9,39</b>
ORFS 9/16"-18h	BSP 3/8"	<b>OR4010406</b>	<b>16,38</b>
ORFS 11/16"-16h	BSP 1/4"	<b>OR4010604</b>	<b>8,79</b>
ORFS 11/16"-16h	BSP 3/8"	<b>OR4010606</b>	<b>9,80</b>
ORFS 13/16"-16h	BSP 1/4"	<b>OR4010804</b>	<b>9,93</b>
ORFS 13/16"-16h	BSP 1/2"	<b>OR4010808</b>	<b>12,43</b>
ORFS 1"-14h	BSP 3/8"	<b>OR4011006</b>	<b>13,26</b>
ORFS 1"-14h	BSP 1/2"	<b>OR4011008</b>	<b>12,95</b>
ORFS 1"3/16-12h	BSP 1/2"	<b>OR4011208</b>	<b>16,38</b>
ORFS 1"3/16-12h	BSP 3/4"	<b>OR4011212</b>	<b>17,24</b>
ORFS 1"3/16-12h	BSP 1"	<b>OR4011216</b>	<b>36,56</b>
ORFS 1"7/16-12h	BSP 1"	<b>OR4011616</b>	<b>29,49</b>
ORFS 1"7/16-12h	BSP 1" 1/4	<b>OR4011620</b>	<b>48,18</b>
ORFS 1"11/16-12h	BSP 1"	<b>OR4012016</b>	<b>41,65</b>
ORFS 1"11/16-12h	BSP 1" 1/4	<b>OR4012020</b>	<b>48,18</b>
ORFS 2"-12h	BSP 1" 1/2	<b>OR4012424</b>	<b>61,57</b>

### Codo 90° macho-hembra giratoria ORFS



**Coude 90° femelle tournante-mâle ORFS**  
**90° Elbow ORFS Swivel female-ORFS male**  
**Raccordo a 90° maschio-femmina girevole ORFS**

ROSCA THREAD		REFERENCIA PART N°	€
ORFS 9/16"-18h		<b>OR6000404</b>	<b>6,36</b>
ORFS 11/16"-16h		<b>OR6000606</b>	<b>7,85</b>
ORFS 13/16"-16h		<b>OR6000808</b>	<b>8,09</b>
ORFS 1"-14h		<b>OR6001010</b>	<b>11,39</b>
ORFS 1"3/16-12h		<b>OR6001212</b>	<b>21,31</b>
ORFS 1"7/16-12h		<b>OR6001616</b>	<b>33,16</b>
ORFS 1"11/16-12h		<b>OR6002020</b>	<b>61,33</b>

## Accesorios ORFS

Accessoires ORFS  
ORFS  
ORFS

Adaptors

### Te Macho ORFS

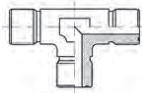

Té égal mâle ORFS

Tee ORFS male

Raccordo a T maschio ORFS

ROSCA THREAD	REFERENCIA PART N°	€
ORFS 9/16"-18h	<b>OR7000404</b>	<b>8,16</b>
ORFS 11/16"-16h	<b>OR7000606</b>	<b>10,66</b>
ORFS 13/16"-16h	<b>OR7000808</b>	<b>13,55</b>
ORFS 1"-14h	<b>OR7001010</b>	<b>15,13</b>
ORFS 1"3/16-12h	<b>OR7001212</b>	<b>16,59</b>
ORFS 1"7/16-12h	<b>OR7001616</b>	<b>39,68</b>
ORFS 1"11/16-12h	<b>OR7002020</b>	<b>41,55</b>
ORFS 2"-12h	<b>OR7002424</b>	<b>74,00</b>

### Te Regulable ORFS-BSP Central

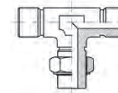

Té mâle ORFS-mâle ORFS-mâle gaz cyl+or+jo+bae central

Central Tee ORFS male-ORFS male adjustable-BSP male

Raccordo a T orientabile ORFS BSP centrale

ROSCA THREAD		REFERENCIA PART N°	€
ORFS 9/16"-18h	BSP 1/8"	<b>OR7030402</b>	<b>4,36</b>
ORFS 9/16"-18h	BSP 1/4"	<b>OR7030404</b>	<b>6,64</b>
ORFS 11/16"-16h	BSP 1/4"	<b>OR7030604</b>	<b>6,52</b>
ORFS 11/16"-16h	BSP 3/8"	<b>OR7030606</b>	<b>7,65</b>
ORFS 13/16"-16h	BSP 3/8"	<b>OR7030806</b>	<b>7,02</b>
ORFS 1"-14h	BSP 1/2"	<b>OR7031008</b>	<b>10,44</b>
ORFS 1"-14h	BSP 3/4"	<b>OR7031012</b>	<b>14,29</b>
ORFS 1"3/16-12h	BSP 3/4"	<b>OR7031212</b>	<b>15,31</b>
ORFS 1"7/16-12h	BSP 1"	<b>OR7031616</b>	<b>24,23</b>
ORFS 1"11/16-12h	BSP 1" 1/4"	<b>OR7032020</b>	<b>34,35</b>

### Te Regulable ORFS-BSP Lateral

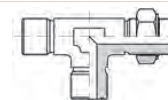

Té mâle ORFS-mâle gaz cyl or+jo+bae+mâleORFS lateral

Lateral Tee ORFS male-BSP male adjustable-ORFS male

Raccordo a T orientabile ORFS BSP laterale

ROSCA THREAD		REFERENCIA PART N°	€
ORFS 9/16"-18h	BSP 1/8"	<b>OR7040402</b>	<b>12,95</b>
ORFS 9/16"-18h	BSP 1/4"	<b>OR7040404</b>	<b>13,10</b>
ORFS 11/16"-16h	BSP 1/4"	<b>OR7040604</b>	<b>4,93</b>
ORFS 11/16"-16h	BSP 3/8"	<b>OR7040606</b>	<b>16,30</b>
ORFS 1"-14h	BSP 3/4"	<b>OR7041012</b>	<b>25,38</b>
ORFS 1"11/16-12h	BSP 1" 1/4"	<b>OR7042020</b>	<b>49,40</b>
ORFS 2"-12h	BSP 1" 1/2"	<b>OR7042424</b>	<b>56,50</b>

### Te macho-macho-hembra giratoria Central



Té mâle ORFS-mâle ORFS-femelle tournante ORFS

Tee ORFS male-ORFS male-ORFS swivel female

Raccordo a T maschio-maschio-femmina girevole centrale ORFS

ROSCA THREAD	REFERENCIA PART N°	€
ORFS 9/16"-18h	<b>OR7010404</b>	<b>13,73</b>
ORFS 11/16"-16h	<b>OR7010606</b>	<b>16,38</b>
ORFS 13/16"-16h	<b>OR7010808</b>	<b>17,89</b>
ORFS 1"-14h	<b>OR7011010</b>	<b>22,54</b>
ORFS 1"3/16-12h	<b>OR7011212</b>	<b>29,69</b>
ORFS 1"7/16-12h	<b>OR7011616</b>	<b>56,11</b>
ORFS 1"11/16-12h	<b>OR7012020</b>	<b>81,70</b>
ORFS 2"-12h	<b>OR7012424</b>	<b>109,41</b>

### Te macho-macho-hembra giratoria Lateral

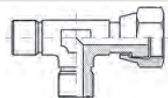

Té mâle ORFS-femelle tournante ORFS-mâle ORFS

Tee ORFS male-ORFS swivel female-ORFS male

Raccordo a T maschio-maschio-femmina girevole laterale ORFS

ROSCA THREAD	REFERENCIA PART N°	€
ORFS 9/16"-18h	<b>OR7020404</b>	<b>6,86</b>
ORFS 11/16"-16h	<b>OR7020606</b>	<b>8,40</b>
ORFS 13/16"-16h	<b>OR7020808</b>	<b>11,74</b>
ORFS 1"-14h	<b>OR7021010</b>	<b>14,27</b>
ORFS 1"3/16-12h	<b>OR7021212</b>	<b>19,52</b>
ORFS 1"7/16-12h	<b>OR7021616</b>	<b>31,90</b>
ORFS 1"11/16-12h	<b>OR7022020</b>	<b>53,24</b>

ORFS

Quick-release  
couplings

Ball valves, diverters

Protections

## Artículos bajo consulta

Articles à consulter | Items on request | Articoli su richiesta

### OR305

**Adaptador hembra giratoria ORFS-macho JIC 37°** | Femelle tournante ORFS-mâle JIC 37° | ORFS Swivel female-JIC 37° male | Adattatore femmina girevole ORFS-maschio JIC 37°

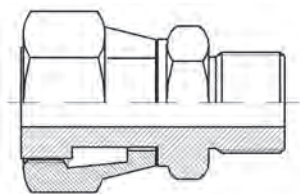

### OR416

**Codo 90° macho ORFS - macho BSPT** | Coude 90° mâle ORFS-mâle BSPT | 90° Elbow ORFS male-BSPT male | Raccordo a 90° maschio ORFS-maschio BSPT

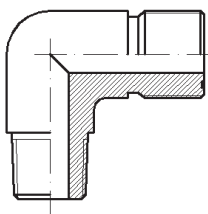

### OR505

**Codo 45° regulable ORFS-UNF** | Coude 45° mâle ORFS-mâle UNF or+jo+bae | Adjustable 45° elbow ORFS male-UNF male | Raccordo a 45° orientabile ORFS-UNF

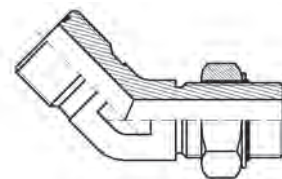

### OR705

**Te Regulable macho ORFS- macho UNF lateral** | Té mâle ORFS-mâle ORFS-mâle UNF+or+jo+bae | Tee ORFS male-ORFS male-lateral UNF adjustable male | Raccordo a T orientabile maschio ORFS-UNF laterale

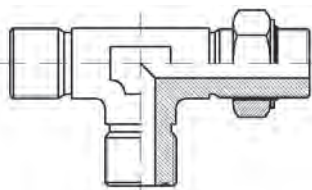

### OR706

**Te Regulable macho ORFS- macho UNF central** | Té mâle ORFS-mâle UNF+or+jo+bae-mâle ORFS | Tee ORFS male-central UNF adjustable male-ORFS male | Raccordo a T orientabile maschio ORFS-UNF centrale

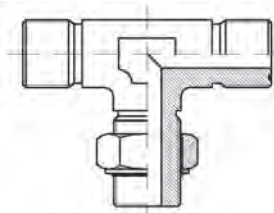

# Enchufes rápidos

Coupleurs rapides  
Quick-release couplings  
Innesti rapidi

# 3

Enchufes rápidos	264
Coupleurs rapides   Quick-release couplings   Innesti rapidi	
Enchufes rápidos y llaves de pasoTrΔle®	265
Coupleurs rapides et robinetsTrΔle®   TrAle quick-release couplings and ball valves   Innesti rapidi e rubinettiTrΔle®	
Multienchufe	266
Multi-coupleur   Multi-way coupling   Multinesti	

# Enchufes rápidos

Coupleurs rapides | Quick-release couplings | Innesti rapidi

Adaptors

## ▶ Enchufes válvula plana | Coupleurs rapides à clapet face plane | Flat face quick release couplings | Innesti a faccia piana 267



A9001/A9002

A9011/A9012

A900...M...P

A9021

A8701/A8702

ORFS

## ▶ Enchufes punzón | Coupleurs rapides à clapet | Quick release couplings | Innesti a valvola 268



A800/A802

A807/A844

A8101/A8102

A8311/A8312

A840

A80/A84

A8201/A8202

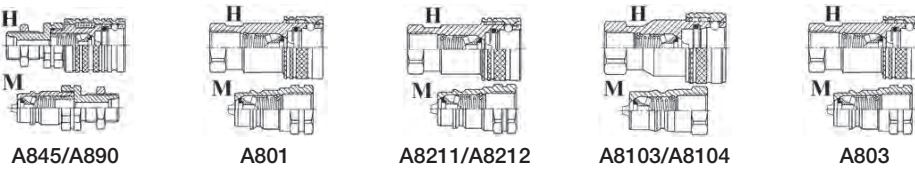

A845/A890

A801

A8211/A8212

A8103/A8104

A803

Quick-release couplings

## ▶ Enchufes autoroscantes | Coupleurs rapides à visser | Quick release screw couplings | Innesti a vite 270



A8008/A8009

Ball valves, diverters

## ▶ Enchufes de bola | Coupleurs rapides à bille | Quick release couplings ball type | Innesti a sfera 270

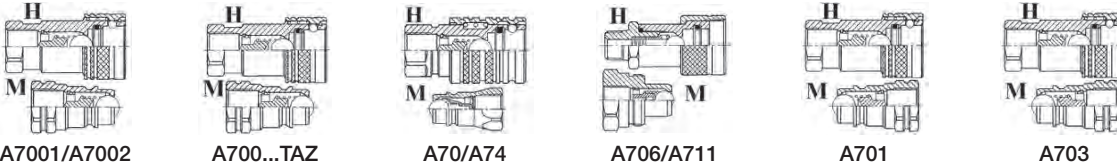

A7001/A7002

A700...TAZ

A70/A74

A706/A711

A701

A703

Protections

## ▶ Válvulas de frenado | Valves freinage | Brake valves | Valvole di frenaggio 271

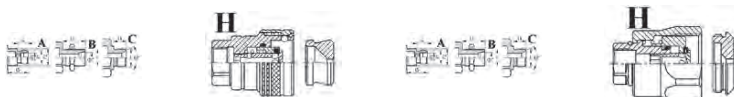

A910/A912

A9102

A9501/A9141

A9502

## ▶ Accesorios para enchufes | Accessoires pour coupleurs rapides | Accessories for couplings | Accessori per innesto rapido 272



A9901/A9902

A9911/A9912

A9931/A9932

NBRA

PTFEA

## ▶ Enchufes rápidos y llaves de paso TrΔle®

Coupleurs rapides et robinets TrΔle® | TrAle quick-release couplings and ball valves | Innesti rapidi e rubinetti TrΔle®

### ▶ Enchufes punzón | Coupleurs rapides à clapet | Quick release couplings | Innesti a valvola

273



B800/B802

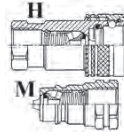

B8101/B8102

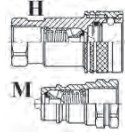

B8201/B8202

### ▶ Enchufes válvula plana y válvulas de frenado | Coupleurs rapides à clapet face plane et valves freinage | Flat face quick release couplings and brake valves | Innesti a faccia piana e valvole di frenaggio

273

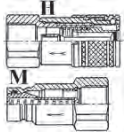

B9001/B9002



B910

### ▶ Llaves de paso | Robinets | Ball valves | Rubinetto a sfera

274



GB2V



GB3V



## Multienchufe

Multi-coupleur | Multi-way coupling | Multinesti

Adaptors

### ▶ Multienchufe 4 vías | Multi-coupleur 4 voies | Multi-way coupling 4 ways | Multinesti 4 vie

275



MEC4S



MEC4

ORFS

### ▶ Multienchufe 2 vías | Multi-coupleur 2 voies | Multi-way coupling 2 ways | Multinesti 2 vie

275



MEC2S



MEC2

Quick-release couplings

### ▶ Accesorios multienchufe | Accessoires Multi-coupleur | Multi-way coupling accessories | Accessori per multinesti

275



A930/A940



--



CEM

Ball valves, diverters

Protections

## Enchufes rápidos

Coupleurs rapides  
Quick-release couplings  
Innesti rapidi

### E.R. Válvula plana Ecológico (rosca BSP)



Coupleur rapide à clapet face plane "Ecologique" filetage BSP  
BSP Ecological flat face coupling  
Innesto rapido a faccia piana Ecologico BSP

DN	ROSCA THREAD	E. C.	REFERENCIA PART N°	€
6	1/4" BSP	M	A900104	16,58
13	3/8" BSP	M	A900106	20,01
13	1/2" BSP	M	A900108	20,01
20	3/4" BSP	M	A900112	31,92
20	1" BSP	M	A900116	65,58
30	1"1/4 BSP	M	A900120	115,53
39	1" 1/2 BSP	M	A900124	225,26
6	1/4" BSP	H	A900204	35,61
13	3/8" BSP	H	A900206	38,17
13	1/2" BSP	H	A900208	38,17
20	3/4" BSP	H	A900212	59,97
25	1" BSP	H	A900216	133,19
30	1"1/4 BSP	H	A900220	182,46
39	1" 1/2 BSP	H	A900224	387,68

### E.R. Válvula plana Ecológico (rosca NPT)



Coupleur rapide à clapet face plane "Ecologique" filetage NPT  
NPT Ecological flat face coupling  
Innesto rapido a faccia piana Ecologico NPT

DN	ROSCA THREAD	E. C.	REFERENCIA PART N°	€
6	1/4" NPT	M	A901104	16,58
13	3/8" NPT	M	A901106	20,01
13	1/2" NPT	M	A901108	20,01
20	3/4" NPT	M	A901112	31,92
25	1" NPT	M	A901116	65,58
30	1"1/4 NPT	M	A901120	115,53
6	1/4" NPT	H	A901204	35,61
13	3/8" NPT	H	A901206	38,17
13	1/2" NPT	H	A901208	38,17
20	3/4" NPT	H	A901212	59,97
20	1" NPT	H	A901216	133,19
30	1"1/4 NPT	H	A901220	182,46

### E.R. Válvula plana pasatabique (rosca Métrica)

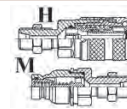

Coupleur rapide à clapet face plane passe cloison (filetage Métrique)  
Flat face coupling bulkhead (Metric thread)  
Innesto a faccia piana passaparete (Metrico)

DN	ROSCA THREAD	E. C.	REFERENCIA PART N°	€
6	M16x1.5	M	A9001M16P	22,09
13	M18x1.5	M	A9001M18P	26,46
20	M26x1.5	M	A9001M26P	45,07
13	M18x1.5	H	A9002M18P	52,32
20	M26x1.5	H	A9002M26P	78,30

### E.R. Válvula plana Ecológico acoplamiento en presión

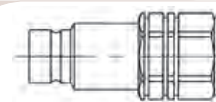

Coupleur rapide à clapet face plane "Ecologique" pression  
Flat face quick release coupling connectable u/pressure  
Innesto rapido a faccia piana Ecologico innestabile in pressione

DN	ROSCA THREAD	E. C.	REFERENCIA PART N°	€
13	1/2" BSP	M	A902108	77,96
20	3/4" BSP	M	A902112	90,38

Se montan con enchufe hembra A870... // À monter avec coupleur femelle A870... //  
To assemble with female coupling A870... // Per montare con innesto femmina A870...

### E.R. Válvula plana para martillos

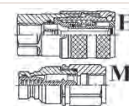

Coupleur rapide à clapet face plane (marteau)  
Flat face quick releale coupling inner threads  
Innesto rapido a faccia piana per martelli

DN	ROSCA THREAD	E. C.	REFERENCIA PART N°	€
6	1/4" BSP	M	A870104	16,82
13	3/8" BSP	M	A870106	22,42
13	1/2" BSP	M	A870108	22,42
20	3/4" BSP	M	A870112	33,97
25	1" BSP	M	A870116	56,08
30	1" 1/4 BSP	M	A870120	118,05
6	1/4" BSP	H	A870204	36,88
13	3/8" BSP	H	A870206	47,76
13	1/2" BSP	H	A870208	47,76
20	3/4" BSP	H	A870212	66,65
25	1" BSP	H	A870216	121,64
30	1" 1/4 BSP	H	A870220	206,62

## Enchufes rápidos

Coupleurs rapides  
Quick-release couplings  
Innesti rapidi

Adaptors

ORFS

Quick-release couplings

Ball valves, diverters

Protections

### E.R. Punzón ISO A (roscas BSP)



Coupleur rapide à clapet norme ISO A  
ISO A Quick release coupling  
Innesto rapido a valvola ISO A (BSP)

DN	ROSCA THREAD	E. C.	REFERENCIA PART N°	€
6	1/4" BSP	M	A800104	5,66
10	3/8" BSP	M	A800106	6,11
13	1/2" BSP	M	A800108	6,22
20	3/4" BSP	M	A800112	13,80
25	1" BSP	M	A800116	31,13
30	1" 1/4 BSP	M	A800120	71,53
39	1" 1/2 BSP	M	A800124	96,87
50	2" BSP	M	A800132	166,95
6	1/4" BSP	H	A800204	11,60
10	3/8" BSP	H	A800206	13,46
13	1/2" BSP	H	A800208	15,28
20	3/4" BSP	H	A800212	27,12
25	1" BSP	H	A800216	56,81
30	1" 1/4 BSP	H	A800220	156,20
39	1" 1/2 BSP	H	A800224	211,36
50	2" BSP	H	A800232	457,47
13	M22X1.5	M	A802122	6,26
13	M22X1.5	H	A802222	16,22

### E.R. ISO Paso total



Coupleur rapide à clapet ISO A pass.total  
ISO A Quick release coupling free flow  
Innesto rapido ISO A passaggio libero

DN	ROSCA THREAD	E. C.	REFERENCIA PART N°	€
6	1/4" BSP	M	A831104	3,98
10	3/8" BSP	M	A831106	4,71
13	1/2" BSP	M	A831108	4,87
20	3/4" BSP	M	A831112	10,93
25	1" BSP	M	A831116	28,59
6	1/4" BSP	H	A831204	10,71
10	3/8" BSP	H	A831206	11,60
13	1/2" BSP	H	A831208	15,76
20	3/4" BSP	H	A831212	26,19
25	1" BSP	H	A831216	54,28

### E.R. Punzón ISO A -acoplamiento a presión residual

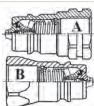

Coupleur rapide à clapet accouplable sous pression résiduelle  
ISO A Quick release coupling (coupling under residual pressure)  
Innesto rapido a valvole ISO a innestabili in pressione residua

DN	ROSCA THREAD	ENCHUFE COUPLING	REFERENCIA PART N°	€
13	1/2" BSP	M (Tipo B)	A807108	14,13
13	1/2" BSP	M (Tipo A)	A844108	14,14

### E.R. Punzón ISO B (roscas BSP)



Coupleur rapide à clapet norme ISO B  
ISO B Quick release coupling  
Innesto rapido a valvola ISO B

DN	ROSCA THREAD	E. C.	REFERENCIA PART N°	€
6	1/4" BSP	M	A810104	6,06
10	3/8" BSP	M	A810106	6,21
13	1/2" BSP	M	A810108	7,30
20	3/4" BSP	M	A810112	15,52
25	1" BSP	M	A810116	34,59
6	1/4" BSP	H	A810204	14,01
10	3/8" BSP	H	A810206	17,49
13	1/2" BSP	H	A810208	24,10
20	3/4" BSP	H	A810212	45,52
25	1" BSP	H	A810216	76,94

### E.R. Push-Pull Punzón hembra

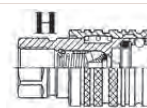

Coupleur rapide à clapet type push-pull femelle norme ISO A  
Female Push-Pull Quick release coupling  
Innesto rapido Push-Pull femmina valvola ISO A

DN	ROSCA THREAD	E. C.	REFERENCIA PART N°	€
13	1/2" BSP	H	A840208	17,28
13	1/2" NPT	H	A841208	17,28
13	M22X1.5	H	A842222	17,28
13	3/4" UNF	H	A843234	17,28

### E.R. Push-Pull Punzón macho

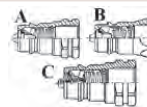

Coupleur rapide à clapet type push-pull mâle norme ISO A  
Male Push-Pull Quick release coupling  
Innesto rapido Push-Pull maschio valvola ISO A

DN	ROSCA THREAD	ENCHUFE COUPLING	REFERENCIA PART N°	€
13	1/2" NPT	M (Tipo A)	A804108	6,49
13	1/2" NPT	M (Tipo A)	A841108	6,49
13	M22X1.5	M (Tipo A)	A842122	6,26
13	1/2" BSP	M (Tipo B)	A840108	6,22
13	3/4" UNF	M (Tipo B)	A843134	6,21
13	1/2" BSP	M (Tipo C)	A805108	14,13
13	1/2" NPT	M (Tipo C)	A806108	14,13

## Enchufes rápidos

Coupleurs rapides  
Quick-release couplings  
Innesti rapidi

### E.R. Punzón Serie NV1 (rosca BSP)



Coupleur rapide à clapet serie NV 1  
Quick release coupling NV1 serie  
Innesto rapido valvola Serie NV1

DN	ROSCA THREAD	E. C.	REFERENCIA PART N°	€
6	1/4" BSP	M	A820104	5,93
10	3/8" BSP	M	A820106	6,35
20	3/4" BSP	M	A820112	15,28
20	1" BSP	M	A820116	33,90
30	1" 1/4 BSP	M	A820120	71,53
39	1" 1/2 BSP	M	A820124	96,64
50	2" BSP	M	A820132	308,23
6	1/4" BSP	H	A820204	12,75
10	3/8" BSP	H	A820206	14,75
20	3/4" BSP	H	A820212	35,23
25	1" BSP	H	A820216	60,68
30	1" 1/4 BSP	H	A820220	148,55
39	1" 1/2 BSP	H	A820224	197,45
50	2" BSP	H	A820232	523,76

### E.R. Punzón Serie NV1 (rosca NPT)



Coupleur rapide à clapet serie NV 1 NPT  
NPT Quick release couplings NV1 serie  
Innesto rapido a valvola serie NV 1 NPT

DN	ROSCA THREAD	E. C.	REFERENCIA PART N°	€
6	1/4" NPT	M	A821104	5,93
10	3/8" NPT	M	A821106	6,35
13	1/2" NPT	M	A821108	6,49
20	3/4" NPT	M	A821112	15,28
25	1" NPT	M	A821116	33,90
30	1" 1/4 NPT	M	A821120	71,53
39	1" 1/2 NPT	M	A821124	96,64
50	2" NPT	M	A821132	308,23
6	1/4" NPT	H	A821204	12,75
10	3/8" NPT	H	A821206	14,75
13	1/2" NPT	H	A821208	16,22
20	3/4" NPT	H	A821212	35,23
25	1" NPT	H	A821216	60,68
30	1" 1/4 NPT	H	A821220	148,55
39	1" 1/2 NPT	H	A821224	197,45
50	2" NPT	H	A821232	523,76

### E.R. John Deere

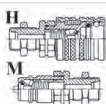

Coupleur rapide à clapet spécial John Deere  
John Deere Quick release coupling  
Innesto rapido Jhon Deere

DN	ROSCA THREAD	E. C.	REFERENCIA PART N°	€
13	3/4" SAE	M	A845112	13,83
13	3/4" SAE	H	A845212	32,44
13	M18X1.5-12L	M	A89011812	9,55
13	M18X1.5-12L	H	A89021812	19,72

### E.R. Punzón ISO A (rosca NPT)



Coupleur rapide à clapet norme ISO A filetage NPT  
ISO A NPT Quick release coupling  
Innesto rapido a valvola ISO A NPT

DN	ROSCA THREAD	E. C.	REFERENCIA PART N°	€
6	1/4" NPT	M	A801104	5,66
10	3/8" NPT	M	A801106	6,11
13	1/2" NPT	M	A801108	6,49
20	3/4" NPT	M	A801112	13,80
25	1" NPT	M	A801116	31,13
30	1" 1/4 NPT	M	A801120	71,53
39	1" 1/2 NPT	M	A801124	96,87
50	2" NPT	M	A801132	166,95
6	1/4" NPT	H	A801204	11,60
10	3/8" NPT	H	A801206	13,46
13	1/2" NPT	H	A801208	16,22
20	3/4" NPT	H	A801212	27,12
25	1" NPT	H	A801216	56,81
30	1" 1/4 NPT	H	A801220	156,20
39	1" 1/2 NPT	H	A801224	211,36
50	2" NPT	H	A801232	457,47

### E.R. Punzón ISO B (rosca NPT)



Coupleur rapide à clapet norme ISO B NPT  
ISO B NPT Quick release couplings  
Innesto rapido a valvola ISO B NPT

DN	ROSCA THREAD	E. C.	REFERENCIA PART N°	€
6	1/4" NPT	M	A810304	6,06
10	3/8" NPT	M	A810306	6,21
13	1/2" NPT	M	A810308	7,30
20	3/4" NPT	M	A810312	15,52
25	1" NPT	M	A810316	34,59
6	1/4" NPT	H	A810404	14,01
10	3/8" NPT	H	A810406	17,49
13	1/2" NPT	H	A810408	24,10
20	3/4" NPT	H	A810412	45,52
25	1" NPT	H	A810416	76,94

### E.R. Punzón ISO A (rosca UNF)

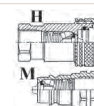

Coupleur rapide à clapet norme ISO A filetage UNF  
ISO A UNF Quick release coupling  
Innesto rapido a valvola ISO B UNF

DN	ROSCA THREAD	E. C.	REFERENCIA PART N°	€
13	3/4" UNF	M	A803112	6,22
13	3/4" UNF	H	A803212	16,22

## Enchufes rápidos

Coupleurs rapides  
Quick-release couplings  
Innesti rapidi

Adaptors

ORFS

Quick-release couplings

Ball valves, diverters

Protections

### E.R. Autoroscantes (rosca BSP)

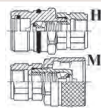

Coupleur rapide à visser taraudage norme DIN forme y filetage BSP  
BSP Quick release screw coupling  
Innesto rapido a vite (BSP)

DN	ROSCA THREAD	E. C.	REFERENCIA PART N°	€
10	1/4" BSP	M	A800804	18,50
10	3/8" BSP	M	A800806	18,50
13	1/2" BSP	M	A800808	17,61
20	3/4" BSP	M	A800812	43,84
25	1" BSP	M	A800816	57,29
10	1/4" BSP	H	A800904	18,50
10	3/8" BSP	H	A800906	18,50
13	1/2" BSP	H	A800908	17,01
20	3/4" BSP	H	A800912	43,84
25	1" BSP	H	A800916	57,29

### E.R. Bola Serie NV (rosca BSP)



Coupleur rapide à bille standard  
BSP Quick release coupling ball type NV Serie  
Innesto rapido a sfera BSP Serie NV

DN	ROSCA THREAD	E. C.	REFERENCIA PART N°	€
6	1/4" BSP	M	A700104	5,61
10	3/8" BSP	M	A700106	7,05
13	1/2" BSP	M	A700108	8,30
20	3/4" BSP	M	A700112	15,90
25	1" BSP	M	A700116	37,31
6	1/4" BSP	H	A700204	11,32
10	3/8" BSP	H	A700206	15,53
13	1/2" BSP	H	A700208	17,61
20	3/4" BSP	H	A700212	35,69
25	1" BSP	H	A700216	66,51

### E.R. Push-Pull bola

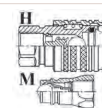

Coupleur rapide à bille Type Push-Pull  
Quick release coupling ball type Push-Pull  
Innesto rapido Push-Pull a sfera

DN	ROSCA THREAD	E. C.	REFERENCIA PART N°	€
13	1/2" BSP	M	A704108	9,07
13	1/2" NPT	M	A705108	9,07
13	1/2" BSP	H	A740208	18,49
13	1/2" NPT	H	A741208	18,49
13	3/4" UNF	H	A702212	18,49

### E.R. Bola Tipo Taz (gondolas y semirem.)

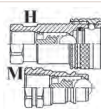

Coupleur rapide à bille Type Taz spécial carrocieres  
Quick release coupling ball type Type Taz (gondolas and semi-tows)  
Innesto rapido a sfera tipo Taz per semirimorchio

DN	ROSCA THREAD	E. C.	REFERENCIA PART N°	€
19	3/4" BSP	M	A700112TAZ	13,69
25	1" BSP	M	A700116TAZ	20,71
19	3/4" BSP	H	A700212TAZ	31,95
25	1" BSP	H	A700216TAZ	48,32

### E.R. Bola altísima presión 700 bar

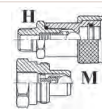

Coupleur rapide à verrouillage vissé haute pression-700 bar  
Quick release coupling ball type very high pressure (700 bar)  
Innesto rapido a sfera 700 bar

DN	ROSCA THREAD	E. C.	REFERENCIA PART N°	€
10	3/8" BSP	M	A706106	21,18
10	3/8" BSP	H	A706206	29,21
6	1/4" NPT	M	A711104	10,24
10	3/8" NPT	M	A711106	10,20
6	1/4" NPT	H	A711204	15,57
10	3/8" NPT	H	A711206	17,06

## Enchufes rápidos

Coupleurs rapides  
Quick-release couplings  
Innesti rapidi

### E.R. Bola Serie NV (rosca NPT)



Coupleur rapide à bille filetage NPT  
NPT Quick release coupling ball type NV Serie  
Innesto rapido a sfera NPT

DN	ROSCA THREAD	E. C.	REFERENCIA PART N°	€
6	1/4" NPT	M	A701104	5,61
10	3/8" NPT	M	A701106	7,05
13	3/8" NPT	M	A701108	8,30
20	3/4" NPT	M	A701112	15,90
25	1" NPT	M	A701116	37,31
6	1/4" NPT	H	A701204	11,32
10	3/8" NPT	H	A701206	15,53
13	1/2" NPT	H	A701208	17,98
20	3/4" NPT	H	A701212	35,69
25	1" NPT	H	A701216	66,51

### E.R. Bola Serie NV (rosca UNF)

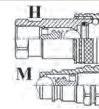

Coupleur rapide à bille filetage UNF  
UNF Quick release coupling ball type NV Serie  
Innesto rapido a sfera UNF

DN	ROSCA THREAD	E. C.	REFERENCIA PART N°	€
13	3/4" UNF	M	A703112	8,30
13	3/4" UNF	H	A703212	18,08

### Válvula de frenado macho



Valve freinage mâle  
Male brake valve  
Valvola di frenaggio maschio

DN	ROSCA THREAD	ENCHUFE COUPLING	REFERENCIA PART N°	€
13	1/2" BSP	M (Tipo C)	A910508	13,85
13	M18X1.5	M (Tipo B)	A912118	13,95
13	M20X1.5	M (Tipo B)	A912120	14,23
13	M22X1.5	M (Tipo B)	A912122	14,46
13	M16X1.5-M20X1.5	M (Tipo A)	A912316	18,27
13	M18X1.5-M20X1.5	M (Tipo AC)	A912318	18,27

### Válvula agrícola macho



Valve agricole à visser mâle  
Male agricultural valve  
Valvola agricola maschio

DN	ROSCA THREAD	ENCHUFE COUPLING	REFERENCIA PART N°	€
13	1/2" BSP	M (Tipo C)	A950108	16,41
13	M18X1.5	M (Tipo B)	A950118	16,41
13	M20X1.5	M (Tipo B)	A950120	16,71
13	M22X1.5	M (Tipo B)	A950122	17,28
13	M16X1,5-M20X1,5	M (Tipo A)	A9141620	17,28
13	M18X1,5 - M20X1,5	M (Tipo A)	A9141820	19,10

### Válvula agrícola hembra

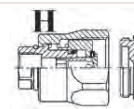

Valve agricole à visser femelle  
Female agricultural valve  
Valvola agricola femmina

DN	ROSCA THREAD	E. C.	REFERENCIA PART N°	€
13	3/8" BSP	H	A950206	22,90
13	M18X1.5	H	A950218	22,90

### Válvula de frenado hembra

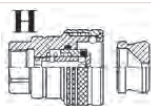

Valve freinage femelle  
Female brake valve  
Valvola di frenaggio femmina

DN	ROSCA THREAD	E. C.	REFERENCIA PART N°	€
13	3/8" BSP	H	A910206	25,86
13	1/2" BSP	H	A910208	25,86
13	M18X1.5	H	A910218	26,33

## Enchufes rápidos

Coupleurs rapides  
Quick-release couplings  
Innesti rapidi

Adaptors

ORFS

Quick-release couplings

Ball valves, diverters

Protections

### Tapones para enchufes rápidos ISO A



Bouchons et capuchons de plastique pour coupleurs norme ISO A  
Plugs for ISO A quick release couplings  
Tappi per ISO A

ROSCA THREAD	ENCHUFE COUPLING	REFERENCIA PART N°	€
1/4"	H	A990104	1,58
3/8"	H	A990106	1,58
1/2"	H	A990108	1,30
3/4"	H	A990112	3,63
1"	H	A990116	4,14
1/4"	M	A990204	1,58
3/8"	M	A990206	1,58
1/2"	M	A990208	1,30
3/4"	M	A990212	3,63
1"	M	A990216	4,62

### Tapones para enchufes de válvula plana



Bouchons et capuchons de plastique pour coupleurs face plane  
Plugs for flat face quick release couplings  
Tappi per innesti a faccia piana

DN	ROSCA THREAD	ENCHUFE COUPLING	REFERENCIA PART N°	€
6	1/4"	H	A993104	3,52
10	3/8"	H	A993106	2,81
13	1/2"	H	A993108	2,81
20	3/4"	H	A993112	3,57
6	1/4"	M	A993204	3,52
10	3/8"	M	A993206	2,81
13	1/2"	M	A993208	2,81
20	3/4"	M	A993212	3,57

### Juego de juntas de reparación e.r. ISO A



Jeu de joints pour coupleur ISO A  
Kit of seals to repair for ISO A quick release coupling  
Guarnizioni per innesto ISO A

ROSCA THREAD	REFERENCIA PART N°	€
1/4" BSP	NBRA04	0,43
3/8" BSP	NBRA06	0,55
1/2" BSP	NBRA08	0,67
3/4" BSP	NBRA12	0,80
1" BSP	NBRA16	0,86

### Tapones para enchufes ISO B



Bouchons et capuchons de plastique pour coupleurs ISO B  
Caps and plugs for ISO B quick release coupling  
Tappi per ISO B

DN	ROSCA THREAD	ENCHUFE COUPLING	REFERENCIA PART N°	€
DN 6	1/4"	H	A991104	4,14
DN 10	3/8"	H	A991106	4,14
DN 10	1/2"	H	A991108	4,14
DN 6	1/4"	M	A991204	4,14
DN 13	3/8"	M	A991206	4,14
DN 13	1/2"	M	A991208	4,14

### Arandelas PTFE



Rondelles PTFE  
PTFE seals  
Rondelle a PTFE

ROSCA THREAD	REFERENCIA PART N°	€
1/4" BSP	PTFEA04	0,74
3/8" BSP	PTFEA06	0,92
1/2" BSP	PTFEA08	0,98
3/4" BSP	PTFEA12	1,53
1" BSP	PTFEA16	1,59

## Enchufes rápidos y llaves de paso TrΔle®

Coupleurs rapides et robinets TrΔle®

TrAle quick-release couplings and ball valves

Innesti rapidi e rubinetti TrΔle®

### E.R. Punzón ISO A



Coupleur rapide à clapet norme ISO A

ISO A Quick release coupling

Innesto rapido a valvola ISO A (BSP)

DN	ROSCA THREAD	E. C.	REFERENCIA PART N°	€
6	1/4" BSP	M	B800104	4,17
10	3/8" BSP	M	B800106	4,76
13	1/2" BSP	M	B800108	5,53
20	3/4" BSP	M	B800112	9,10
25	1" BSP	M	B800116	15,47
6	1/4" BSP	H	B800204	8,93
10	3/8" BSP	H	B800206	10,41
13	1/2" BSP	H	B800208	12,85
20	3/4" BSP	H	B800212	21,30
25	1" BSP	H	B800216	36,66

### E.R. Punzón ISO B



Coupleur rapide à clapet norme ISO B

ISO B Quick release coupling

Innesto rapido a valvola ISO B

DN	ROSCA THREAD	E. C.	REFERENCIA PART N°	€
6	1/4" BSP	M	B810104	4,58
10	3/8" BSP	M	B810106	5,24
13	1/2" BSP	M	B810108	6,07
20	3/4" BSP	M	B810112	10,06
25	1" BSP	M	B810116	15,83
6	1/4" BSP	H	B810204	9,82
10	3/8" BSP	H	B810206	11,49
13	1/2" BSP	H	B810208	14,16
20	3/4" BSP	H	B810212	23,45
25	1" BSP	H	B810216	36,89

### E.R. Punzón Serie NV1

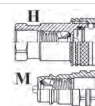

Coupleur rapide à clapet serie NV 1

Quick release coupling NV1 serie

Innesto rapido valvola Serie NV1

DN	ROSCA THREAD	E. C.	REFERENCIA PART N°	€
6	1/4" BSP	M	B820104	4,46
10	3/8" BSP	M	B820106	5,12
20	3/4" BSP	M	B820112	9,76
25	1" BSP	M	B820116	15,41
6	1/4" BSP	H	B820204	9,58
6	1/4" BSP	H	B820206	11,13
20	3/4" BSP	H	B820212	22,79
25	1" BSP	H	B820216	35,88

1/2" IDEM ISO A (B800108/B800208)

### E.R. Válvula plana Ecológico

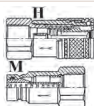

Coupleur rapide à clapet face plane "Ecologique"

Ecological flat face coupling

Innesto rapido a faccia piana Ecologico

DN	ROSCA THREAD	E. C.	REFERENCIA PART N°	€
6	1/4" BSP	M	B900104	9,58
13	3/8" BSP	M	B900106	14,28
20	1/2" BSP	M	B900108	19,86
25	3/4" BSP	M	B900112	26,18
25	1" BSP	M	B900116	35,04
6	1/4" BSP	H	B900204	24,94
13	3/8" BSP	H	B900206	33,32
20	1/2" BSP	H	B900208	44,03
25	3/4" BSP	H	B900212	56,56
25	1" BSP	H	B900216	81,79

### Válvulas de frenado



Valves freinage

Brake valves

Valvole di frenaggio

DN	ROSCA THREAD	ENCHUFE COUPLING	REFERENCIA PART N°	€
13	1/2" BSP	M (TIPO C)	B910508	9,64
13	1/2" BSP	H	B910208	21,42



## Enchufes rápidos y llaves de paso TrΔle®

Coupleurs rapides et robinets TrΔle®

TrAle quick-release couplings and ball valves

Innesti rapidi e rubinetti TrΔle®

Adaptors

ORFS

Quick-release couplings

Ball valves, diverters

Protections

### Llaves paso dos vías hembra BSP con agujeros



Robinet 2 voies boisseau sphérique BSP avec trous de fixation

2 way ball valves BSP female with fixing holes

Rubinetto a due vie con fori di fissaggio

DN	ROSCA THREAD	REFERENCIA PART N°	€
6	1/4" BSP	<b>GB2V 1/4</b>	<b>22,39</b>
10	3/8" BSP	<b>GB2V 3/8</b>	<b>23,64</b>
13	1/2" BSP	<b>GB2V 1/2</b>	<b>26,24</b>
20	3/4" BSP	<b>GB2V 3/4</b>	<b>46,41</b>
25	1" BSP	<b>GB2V 1</b>	<b>64,21</b>

### Llave paso tres vías



Robinets 3 voies

3 way ball valves

Rubinetto a tre vie

DN	ROSCA THREAD	REFERENCIA PART N°	€
10	3/8" BSP	<b>GB3V 3/8</b>	<b>43,86</b>
13	1/2" BSP	<b>GB3V 1/2</b>	<b>51,01</b>
20	3/4" BSP	<b>GB3V 3/4</b>	<b>66,31</b>

## Multienchufe

Multi-coupleur  
Multi-way coupling  
Multinesti

### Multienchufe 4 vías sin enchufes



Multi-coupleur 4 voies sans connecteur  
Multi-way coupling 4 ways without connector  
Piastra multi-innesti a 4 linee, senza innesti

Descripción Description	E. C.	Nº VIAS Nº WAYS	REFERENCIA PART N°	€
-	-	4	<b>MEC4S</b>	<b>232,63</b>
Eléctrico	-	4	<b>MEC4SE</b>	<b>265,20</b>

Los Multienchufes eléctricos se suministrarán sin conector//Les Multi-coupleurs électriques seront fournis sans connecteur//The Multi-way electric couplings are supplied without connector//Le piastra multi-innesti elettriche sono fornite senza connettori

### Multienchufe 4 vías con enchufes



Multi-coupleur 4 voies avec connecteur  
Multi-way coupling 4 ways with connector  
Piastra multi-innesti a 4 linee, con innesti

Descripción Description	ENCHUFE COUPLING	Nº VIAS Nº WAYS	REFERENCIA PART N°	€
-	2 x H 1/2" BSP	4	<b>MEC42H08</b>	<b>403,56</b>
-	2 x M 1/2" BSP	4	<b>MEC42M08</b>	<b>403,56</b>
-	4 x H 1/2" BSP	4	<b>MEC44H08</b>	<b>574,41</b>
-	4 x M 1/2" BSP	4	<b>MEC44M08</b>	<b>574,52</b>
Eléctrico	4 x M 1/2" BSP	4	<b>MEC44M08E</b>	<b>626,08</b>
Eléctrico	4 x H 1/2" BSP	4	<b>MEC44H08E</b>	<b>626,08</b>
Eléctrico	2 x M 1/2" BSP	4	<b>MEC42M08E</b>	<b>485,57</b>
Eléctrico	2 x H 1/2" BSP	4	<b>MEC42H08E</b>	<b>485,57</b>

Los Multienchufes eléctricos se suministrarán sin conector//Les Multi-coupleurs électriques seront fournis sans connecteur//The Multi-way electric couplings are supplied without connector//Le piastra multi-innesti elettriche sono fornite senza connettori

### Multienchufe 2 vías sin enchufes



Multi-coupleur 2 voies sans connecteur  
Multi-way coupling 2 ways without connector  
Piastra multi-innesti a 2 linee, senza innesti

Descripción Description	E. C.	Nº VIAS Nº WAYS	REFERENCIA PART N°	€
-	-	2	<b>MEC2S</b>	<b>178,53</b>
Eléctrico	-	2	<b>MEC2SE</b>	<b>214,20</b>

Los Multienchufes eléctricos se suministrarán sin conector//Les Multi-coupleurs électriques seront fournis sans connecteur//The Multi-way electric couplings are supplied without connector//Le piastra multi-innesti elettriche sono fornite senza connettori

### Multienchufe 2 vías con enchufes



Multi-coupleur 2 voies avec connecteur  
Multi-way coupling 2 ways with connector  
Piastra multi-innesti a 2 linee, con innesti

Descripción Description	ENCHUFE COUPLING	Nº VIAS Nº WAYS	REFERENCIA PART N°	€
-	2 x H 1/2" BSP	2	<b>MEC22H08</b>	<b>349,50</b>
-	2 x M 1/2" BSP	2	<b>MEC22M08</b>	<b>349,50</b>
Eléctrico	2 x H 1/2" BSP	2	<b>MEC22H08E</b>	<b>401,06</b>
Eléctrico	2 x M 1/2" BSP	2	<b>MEC22M08E</b>	<b>401,06</b>

Los Multienchufes eléctricos se suministrarán sin conector//Les Multi-coupleurs électriques seront fournis sans connecteur//The Multi-way electric couplings are supplied without connector//Le piastra multi-innesti elettriche sono fornite senza connettori

### Enchufes rápidos



Coupleurs rapides  
Quick-release couplings  
Innesti rapidii

ROSCA THREAD	ENCHUFE COUPLING	REFERENCIA PART N°	€
H 1/2" BSP	M	<b>A930108</b>	<b>42,76</b>
H 1/2" BSP	H	<b>A930208</b>	<b>42,76</b>
M 1/2" BSP	M	<b>A940108</b>	<b>42,76</b>
M 1/2" BSP	H	<b>A940208</b>	<b>42,76</b>

### Repuestos



Pièces de rechange  
Spare parts  
Pezzi di ricambio

Descripción Description	REFERENCIA PART N°	€
Conj. Tapa	<b>MEC4TP</b>	<b>81,15</b>
Conj. Tapa Electr.	<b>MEC4TPEL</b>	<b>97,38</b>
Chapa Sujeción	<b>MEC4CS</b>	<b>10,28</b>
Conjunto accionamiento	<b>MEC4ACC</b>	<b>45,99</b>
Conjunto cierre	<b>MEC4SG</b>	<b>9,92</b>

# Multienchufe

Multi-coupleurs | Multiway couplings | Multinnesti 4 vie

Adaptors

ORFS

Quick-release couplings

Ball valves, diverters

Protections

## Características | Caractéristiques | Characteristics | Caratteristiche

- “Fugas Cero” enchufes ecológicos de caras planas
- Se pueden acoplar y desacoplar en presión
- Cómoda apertura y cierre
- Fácil mantenimiento y limpieza
- Como opción se puede suministrar con acoplamiento eléctrico integrado
- Pas de fuites: coupleurs écologiques face plane
- Ils peuvent s'accoupler / des'accoupler en pression
- Ouverture / fermeture facile
- Entretien / maintenance facile
- En option peut être fourni avec accouplement électrique intégré
- “No leaks” flat face “Ecological” quick couplings
- They can be coupled and uncoupled within pressure
- Handy opening and closing
- Easy to maintain and to clean
- Option: they could be supplied with an electric coupling integrated
- “Zero perdita”, innesto rapido ecologico faccia piana
- Innestabile e disinnestabile in pressione
- Comoda apertura e chiusura
- Facile manutenzione e pulizia
- Opzione: Possibile fornitura con accoppiamento elettrico integrato



**Disponibles con roscas hembra BSP-1/2 o macho BSP-1/2. Se suministran con 2 ó 4 enchufes** | Disponibles avec filetages femelle BSP-1/2 ou mâle BSP-1/2. Ils sont livrés avec 2 ou 4 coupleurs | Available with thread female BSP 1/2 or male BSP 1/2. They are supplied with 2 or 4 couplings | Disponibili con filetti femina BSP 1/2 o maschio BSP 1/2, sono fornibili con 2 o 4 innesti.



## Accesorios | Accessoires | Accessories | Accessori

**Tapa de protección** | Couvercle de protection | Protection cap | Tappo di protezione



**Chapa de sujeción** | Plaque de fixation | Subjection plate | Piastra di sicurezza

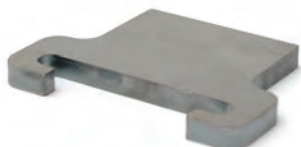

**Enchufes repuesto** | Coupleurs de réchange | Spare couplings | Innesti di ricambio



Referencia   Référence Part No.   Codice	Descripción   Description Description   Descrizione	Uds caja   Pcs. boîte Pcs./box   Uds. box	€
MEC44H08	Multienchufe 4 rosca hembra BSP   Multicoupleur 4 filetage femelle BSP Multi quick coupling 4 thread female BSP   Multinnesto 4 filetto femina BSP	1	475,71
MEC42H08	Multienchufe 2 rosca hembra BSP   Multicoupleur 2 filetage femelle BSP Multi quick coupling 2 thread female BSP   Multinnesto 2 filetto femina BSP	1	325,71
MEC44M08	Multienchufe 4 rosca macho BSP   Multicoupleur 4 filetage mâle BSP Multi quick coupling 4 thread male BSP   Multinnesto 4 filetto maschio BSP	1	492,86
MEC42M08	Multienchufe 2 rosca macho BSP   Multicoupleur 2 filetage mâle BSP Multi quick coupling 2 thread male BSP   Multinnesto 2 filetto maschio BSP	1	342,86

## Accesorios | Accessoires | Accessories | Accessori

Referencia   Référence Part No.   Codice	Descripción   Description Description   Descrizione	Uds caja   Pcs. boîte Pcs./box   Uds. box	€
MEC4TP	Tapa de protección multienchufes 4 vías   Couvercle de protection multi-coupleurs 4 voies 4 ways multi quick coupling protection cap   Tappo di protezione per multinnesti 4 vie	12	64,29
MEC4CS	Chapa de sujeción multienchufes   Tape de fixation multi-coupleurs Multi quick couplings subjection plate   Piastra di sicurezza per multinnesti 4 vie	15	8,14

## Repuestos | Pieces de réchange | Spare parts | Ricambi

Referencia   Référence Part No.   Codice	Descripción   Description Description   Descrizione	Uds caja   Pcs. boîte Pcs./box   Uds. box	€
A930108	Enchufe macho - rosca hembra 1/2   Coupleur mâle - filetage femelle 1/2 Male quick coupling - female thread 1/2   Innesto maschio - filetto femina 1/2	10	34,91
A930208	Enchufe hembra - rosca hembra 1/2   Coupleur femelle - filetage femelle 1/2 Female quick coupling - female thread 1/2   Innesto femina - filetto femina 1/2	10	34,91
A940108	Enchufe macho - rosca macho 1/2   Coupleur mâle - filetage mâle 1/2 Male quick coupling - male thread 1/2   Innesto maschio - filetto maschio 1/2	10	37,33
A940208	Enchufe hembra - rosca macho 1/2   Coupleur mâle - filetage femelle 1/2 Male quick coupling - female thread 1/2   Innesto femina - filetto maschio 1/2	10	37,33

# Multienchufe

Multi-coupleur  
Multi-way coupling  
Multinesti

## Componentes eléctricos



Composants électriques  
Electrical components  
Componenti elettrici

Descripción Description	REFERENCIA PART N°	€
Conector H	<b>CEM1-H</b>	<b>8,97</b>
Conector M	<b>CEM1-M</b>	<b>17,62</b>

▶ MEC4TP

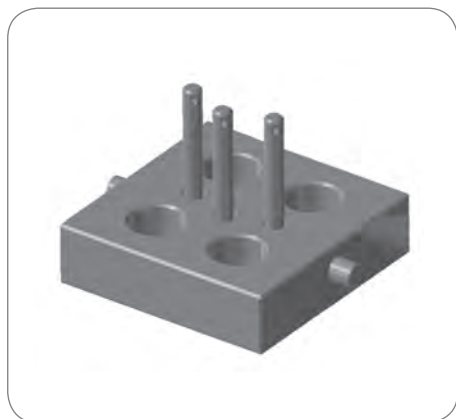

▶ MEC4ACC



▶ MEC4TPEL

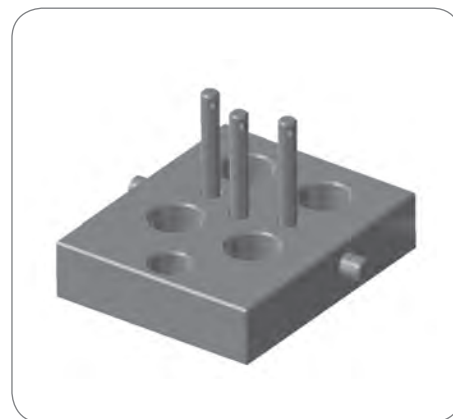

▶ MEC4SG



▶ MEC4GIR



▶ MEC4CS



Adaptors

ORFS

Quick-release couplings

Ball valves, diverters

Protections

# Llaves paso, desviadores y racores giratorios

Robinets, déviateurs et raccords tournants

Ball valves, diverters and swivel fittings

Rubinetti, deviatori, raccordi girevoli

# 4

Llaves de paso Robinets   Ball valves   Rubinetti a sfera	280
Desviadores Déviateurs   Diverters   Deviatori di flusso	281
Racores giratorios Raccords tournants   Swivel fittings   Raccordi girevoli	282

## Llaves de paso

Robinets | Ball valves | Rubinetti a sfera

Adaptors

### ▶ De 2 vías | Robinets haute pression 2 voies | 2 Ways ball valve | Rubinetti a sfera 2 vie

283



BKH G



BKH G DN



BKH G NPT



BKH L



BKH L DN



BKH S



BKH S DN

ORFS

### ▶ De 3 vías | Robinets haute pression 3 voies | 3 Ways ball valve | Rubinetti a sfera 3 vie

284



BK3 G



A6003



3KH G



A600

Quick-release couplings

### ▶ De 4 vías | Robinets haute pression 4 voies | 4 Ways ball valve | Rubinetti a sfera 4 vie

284



4KH G

Ball valves, diverters

### ▶ Llaves de baja presión | Robinets basse pression | Ball valves low pressure | Rubinetti a sfera bassa pressione

286



BP2V



BP2VA

Protections

# Desviadores

Déviateurs | Diverters | Deviatori di flusso

287

## Desviadores manuales | Déviateurs manuels | Manual diverters | Deviatori di flusso manuali



D3V



D4V



D6V



## Racores giratorios

Raccords tournants | Swivel fittings | Raccordi girevoli

Adaptors

ORFS

Quick-release  
couplings

Ball valves, diverters

Protections

### ▶ **Racores giratorios (50 rev/min)** | Raccords tournants (max. 50 tr/min) | Swivel fittings | Raccordi girevoli

288



GGL



GG90

## Llaves de paso

Robinets  
Ball valves  
Rubinetti a sfera

### Llave 2 vías rosca hembra BSP con agujeros



Robinet haute pression 2 voies boisseau sphérique BSP avec trous de fixation  
**2 Ways ball valve BSP female with holes**  
Rubinetto a sfera femmina-femmina BSP

DN	ROSCA THREAD	REFERENCIA PART N°	€
4	1/8" BSP	BKH G 1/8	35,82
6	1/4" BSP	BKH G 1/4	27,56
10	3/8" BSP	BKH G 3/8	24,80
13	1/2" BSP	BKH G 1/2	28,13
20	3/4" BSP	BKH G 3/4	60,73
25	1" BSP	BKH G 1	81,63
25	1" 1/4 BSP	BKH G 1 1/4 DN25	103,45
25	1" 1/2 BSP	BKH G 1 1/2 DN25	137,18

### Llave 2 vías tubo rígido Serie Ligera



Robinet haute pression 2 voies boisseau sphérique sortie pour tube rigide DIN Série Légère  
**2 Ways ball valve: tube connection Serie Light**  
Rubinetto a sfera maschio DIN 2353 Serie L

DN	TUBO PIPE	ROSCA THREAD	REFERENCIA PART N°	€
4	6L	M12x1.5	BKH 6 L	34,94
6	8L	M14x1.5	BKH 8 L	27,66
8	10L	M16x1.5	BKH 10 L	35,98
10	12L	M18x1.5	BKH 12 L	34,23
13	15L	M22x1.5	BKH 15 L	38,32
16	18L	M26x1.5	BKH 18 L	82,78
20	22L	M30x2	BKH 22 L	85,98
25	28L	M36x2	BKH 28 L	113,75

### Llave de paso BSP hembra ISO 228 paso total



Robinets haute pression 2 voies boisseau sphérique femelle ISO 228  
**Ball-valves BSP female ISO 228**  
Rubinetto a sfera femmina BSP ISO228

DN	ROSCA THREAD	REFERENCIA PART N°	€
32	1" 1/4 BSP	BKH G 1 1/4 DN32	292,92
40	1" 1/2 BSP	BKH G 1 1/2 DN40	338,45
50	2" BSP	BKH G 2 DN50	502,13

### Llave 2 vías tubo rígido L paso total



Robinets haute pression 2 voies boisseau sphérique femelle ISO 228  
**Ball-valves: tube connection L serie DIN 2353 full bore**  
Rubinetto a sfera maschio DIN 2353 -L-

DN	TUBO PIPE	ROSCA THREAD	REFERENCIA PART N°	€
32	35L	M45x2	BKH 35 L DN32	334,42
40	40L	M52x2	BKH 42 L DN40	443,55

### Llave 2 vías tubo rígido Serie Pesada



Robinet haute pression 2 voies boisseau sphérique sortie pour tube rigide din Série Lourde  
**2 Ways ball valve: tube connection Serie Heavy**  
Rubinetto a sfera maschio DIN Serie S

DN	TUBO PIPE	ROSCA THREAD	REFERENCIA PART N°	€
4	8S	M16x1.5	BKH 8 S	38,80
6	10S	M18x1.5	BKH 10 S	32,46
8	12S	M20x1.5	BKH 12 S	29,65
10	14S	M22x1.5	BKH 14 S	54,34
13	16S	M24x1.5	BKH 16 S	36,87
16	20S	M30x2	BKH 20 S	82,78
20	25S	M36x2	BKH 25 S	82,39
25	30S	M42x2	BKH 30 S	110,94

### Llave 2 vías rosca hembra NPT



Robinet haute pression 2 voies boisseau sphérique sortie femelle briggs (NPT)  
**2 Ways ball valve NPT female**  
Rubinetto a sfera 2 vie femmina NPT

DN	ROSCA THREAD	REFERENCIA PART N°	€
6	1/4" NPT	BKH G 1/4 NPT	51,75
10	3/8" NPT	BKH G 3/8 NPT	59,96
13	1/2" NPT	BKH G 1/2 NPT	70,16
20	3/4" NPT	BKH G 3/4 NPT	114,14
25	1" NPT	BKH G 1 NPT	147,48
32	1" 1/4 NPT	BKH G 1 1/4 NPT	196,86
40	1" 1/2 NPT	BKH G 1 1/2 NPT	208,93
50	2" NPT	BKH G 2 NPT	484,16

### Llave 2 vías tubo rígido S paso total



Robinets haute pression 2 voies boisseau sphérique métrique Série Lourde passage total  
**Ball-valves: tube connection S serie DIN 2353 full bore**  
Rubinetto a sfera maschio DIN 2353 -S-

DN	TUBO PIPE	ROSCA THREAD	REFERENCIA PART N°	€
32	38S	M52x2	BKH 38 S DN32	340,10

## Llaves de paso

Robinets  
Ball valves  
Rubinetti a sfera

Adaptors

ORFS

Quick-release couplings

Ball valves, diverters

Protections

### Llave 3 vías hembra-hembra-hembra BSP (Tipo L)



Robinet haute pression 3 voies série "L" boisseau sphérique femelle-femelle-femelle BSP

**3 Ways ball valve BSP female-female-female (Type L)**

**Rubinetto a sfera 3 vie femmina (Tipo L)**

DN	ROSCA THREAD	REFERENCIA PART N°	€
6	1/4" BSP	<b>BK3 G 1/4</b>	<b>89,12</b>
10	3/8" BSP	<b>BK3 G 3/8</b>	<b>80,09</b>
13	1/2" BSP	<b>BK3 G 1/2</b>	<b>89,67</b>
20	3/4" BSP	<b>BK3 G 3/4</b>	<b>206,51</b>
25	1" BSP	<b>BK3 G 1</b>	<b>254,07</b>

### Llave 3 vías hembra-macho-hembra BSP (Tipo L)



Robinet haute pression 3 voies série "L" boisseau sphérique femelle-mâle-femelle BSP

**3 Ways ball valve BSP female-male-female (Type L)**

**Rubinetto a sfera 3 vie femmina-maschio-femmina BSP (Tipo L)**

DN	ROSCA THREAD	REFERENCIA PART N°	€
6	1/4" BSP	<b>A600304</b>	<b>64,48</b>
10	3/8" BSP	<b>A600306</b>	<b>65,86</b>
13	1/2" BSP	<b>A600308</b>	<b>62,81</b>
20	3/4" BSP	<b>A600312</b>	<b>162,30</b>
25	1" BSP	<b>A600316</b>	<b>176,69</b>
25	1"1/4 BSP	<b>A600320</b>	<b>539,01</b>
25	1"1/2 BSP	<b>A600324</b>	<b>591,48</b>

Con agujeros de fijación // Avec des trous de montage // With mounting holes  
// Con fori di montaggio

### Llave 3 vías hembra multivía (Tipo L)



Robinet haute pression 3 voies série "L" boisseau sphérique femelle gaz

**Multi-way ball valves female 3 ways (Type L)**

**Rubinetto a sfera 3 vie femmina (Tipo L)**

DN	ROSCA THREAD	REFERENCIA PART N°	€
4	1/8" BSP	<b>3KH G 1/8</b>	<b>305,88</b>
6	1/4" BSP	<b>3KH G 1/4</b>	<b>246,02</b>
10	3/8" BSP	<b>3KH G 3/8</b>	<b>299,54</b>
13	1/2" BSP	<b>3KH G 1/2</b>	<b>421,23</b>
20	3/4" BSP	<b>3KH G 3/4</b>	<b>629,72</b>
25/32	1" 1/4 BSP	<b>3KH G 1 1/4</b>	<b>798,14</b>
25/40	1" 1/2 BSP	<b>3KH G 1 1/2</b>	<b>811,04</b>

### Llaves especiales 2 y 3 vías



Robinets spéciaux 2 et 3 voies

**Special 2 and 3 way valves**

**Rubinetti spaciali 2 e 3 vie**

ROSCA THREAD	Descripción Description	REFERENCIA PART N°	€
1/2" BSP	2 Vías	<b>A600208CC</b>	<b>236,12</b>
1/2" BSP	3 Vías	<b>A60030810</b>	<b>227,96</b>

### Llave 4 vías rosca hembra BSP (Tipo L)



Robinet haute pression 4 voies série "L" boisseau sphérique femelle gaz

**Multi-way ball valves female 4 ways (Type L)**

**Rubinetto 4 vie femmina BSP (Tipo L)**

DN	ROSCA THREAD	REFERENCIA PART N°	€
4	1/8" BSP	<b>4KH G 1/8</b>	<b>355,37</b>
6	1/4" BSP	<b>4KH G 1/4</b>	<b>275,62</b>
10	3/8" BSP	<b>4KH G 3/8</b>	<b>304,00</b>
13	1/2" BSP	<b>4KH G 1/2</b>	<b>423,49</b>
20	3/4" BSP	<b>4KH G 3/4</b>	<b>692,27</b>
25	1" BSP	<b>4KH G 1</b>	<b>823,16</b>
25/32	1" 1/4 BSP	<b>4KH G 1 1/4</b>	<b>909,74</b>
25/40	1" 1/2 BSP	<b>4KH G 1 1/2</b>	<b>922,14</b>



TIPO L



TIPO T



TIPO X

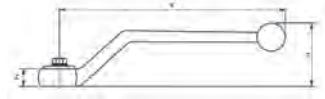

## Manetas | Leviers pour Robinets | Handles for Ball-Valves | Manopole

Para llaves de paso   Pour robinets For ball-valves   Per rubinetti a sfera	SW	Standard zinc   Standard zinc Standard zinc   Standard zinco		Acero   Acier Steel   Acciaio		INOX/SS316L	
		Referencia   Référence Part no.   Codice	€	Referencia   Référence Part no.   Codice	€	Referencia   Référence Part no.   Codice	€
Serie BSP 1/8 - 1/4 - 3/8 - 1/2 - 5/8	9	A60013155330	*	C600063	*	Z60013155330	*
Serie DIN 6 - 8 - 10 - 12 - 14 - 15 - 16 - 18							
Serie BSP 3/4 - 1 - 1 1/4	14	-	*	C708618	*	Z60013155331	*
Serie DIN 22 - 25 - 28 - 30 - 35 - 38							
Serie BSP 1 1/4 - 1 1/2 - 2	17	-	*	-	*	Z60013155332	*
Serie DIN 35 - 38 - 42							

## Solo se suministra en aluminio | Seulement disponible en aluminium | Only supplied in aluminium | Disponibile solo in alluminio

Para llaves de paso   Pour robinets For ball-valves   Per rubinetti a sfera	SW	Referencia   Référence Part no.   Codice	€
Serie BSP 5/8	12	L501741	*
Serie DIN 15 - 16 - 18			

## Manetas | Leviers pour Robinets | Handles for Ball-Valves | Manopole



Para llaves de paso   Pour robinets For ball-valves   Per rubinetti a sfera	SW	Zinc   Zinc Zinc   Zinco		Aluminio   Aluminium Aluminum   Alluminio	
		Referencia   Référence Part no.   Codice	€	Referencia   Référence Part no.   Codice	€
Serie BSP 1/8 - 1/4 - 3/8 - 1/2 - 5/8	9	AR603722	*	-	*
Serie DIN 6 - 8 - 10 - 12 - 14 - 15 - 16 - 18					
Serie BSP 3/4 - 1 - 1 1/4	14	A60013155331	*	LR606745	*
Serie DIN 22 - 25 - 28 - 30 - 35 - 38					
Serie BSP 1 1/4 - 1 1/2 - 2	17	-	*	LR801799	*
Serie DIN 35 - 38 - 42					

## Llaves de paso

Robinets  
Ball valves  
Rubinetti a sfera

Adaptors

ORFS

Quick-release  
couplings

Ball valves, diverters

Protections

### Llave de esfera paso total baja presión



Robinet basse pression 2 voies boisseau sphérique passage total pn 16/25  
2 Ways ball valve low pressure  
Rubinettio a sfera bassa pressione passaggio totale

DN	ROSCA THREAD	REFERENCIA PART N°	€
6	1/4" BSP	<b>BP2V14</b>	<b>6,63</b>
10	3/8" BSP	<b>BP2V38</b>	<b>6,63</b>
13	1/2" BSP	<b>BP2V12</b>	<b>6,55</b>
20	3/4" BSP	<b>BP2V34</b>	<b>10,38</b>
25	1" BSP	<b>BP2V1</b>	<b>15,92</b>
32	1"1/4 BSP	<b>BP2V114</b>	<b>25,07</b>
40	1"1/2 BSP	<b>BP2V112</b>	<b>35,84</b>
50	2" BSP	<b>BP2V2</b>	<b>56,59</b>
80	3" BSP	<b>BP2V3</b>	<b>171,64</b>
100	4" BSP	<b>BP2V4</b>	<b>269,50</b>

### Llave de esfera paso total baja presión anti-hielo



Robinet basse pression 2 voies boisseau sphérique passage total pn 25 anti-gel  
2 Ways ball valve low pressure no-frost  
Rubinettio a sfera, passaggio totale, anti-gelo

ROSCA THREAD	REFERENCIA PART N°	€
1/4" BSP	<b>BP2VA14</b>	<b>6,08</b>
3/8" BSP	<b>BP2VA38</b>	<b>6,08</b>
1/2" BSP	<b>BP2VA12</b>	<b>7,44</b>
3/4" BSP	<b>BP2VA34</b>	<b>11,08</b>
1" BSP	<b>BP2VA1</b>	<b>16,77</b>
1" 1/4 BSP	<b>BP2VA114</b>	<b>27,02</b>
1" 1/2 BSP	<b>BP2VA112</b>	<b>38,83</b>
2" BSP	<b>BP2VA2</b>	<b>63,03</b>
2" 1/2 BSP	<b>BP2VA212</b>	<b>119,17</b>
3" BSP	<b>BP2VA3</b>	<b>202,42</b>
4" BSP	<b>BP2VA4</b>	<b>286,50</b>

# Desviadores

Déviateurs  
Diverter  
Deviatori di flusso

## Desviador de 3 vías rosca hembra BSP



Déviateur manuel 3 voies femelle BSP  
3 Way diverter BSP female  
Deviatore di flusso 3 vie femmina

DN	ROSCA THREAD	REFERENCIA PART N°	€
10	3/8" BSP	D3V38	54,18
13	1/2" BSP	D3V12	61,73
20	3/4" BSP	D3V34	71,97
25	1" BSP	D3V10	89,56

## Desviador de 4 vías



Déviateur manuel 4 voies femelle BSP  
4 Way diverter BSP female  
Deviatore di flusso 4 vie femmina

ROSCA THREAD	REFERENCIA PART N°	€
1/2" BSP	D4V12	77,84
3/8" BSP	D4V38	68,76

## Desviador de 6 vías



Déviateur manuel 6 voies femelle BSP  
6 Way diverter BSP female  
Deviatore di flusso 6 vie femmina

DN	ROSCA THREAD	REFERENCIA PART N°	€
10	3/8" BSP	D6V38	123,94
13	1/2" BSP	D6V12	137,36

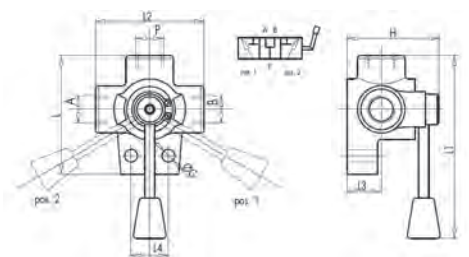

**Desviador de 3 vías. Presión máx. 250 bar** | Vanne agricole 3 voies. Pression max 250 bar | 3 ways flow divider. Max pressure 250 bar | Deviatori di flusso a 3 vie. Pressione max 250 bar

Referencia Part no.	A-B P Gas	L (mm)	L1 (mm)	L2 (mm)	L3 (mm)	L4 (mm)	ØG (mm)	H (mm)
D3V38	3/8	76	140	68	25	26	8,5	67
D3V12	1/2	87	145	80	28	32	8,5	70
D3V34	3/4	103	150	94	30	32	11	78
D3V10	1	105	152	98	30	32	11	82

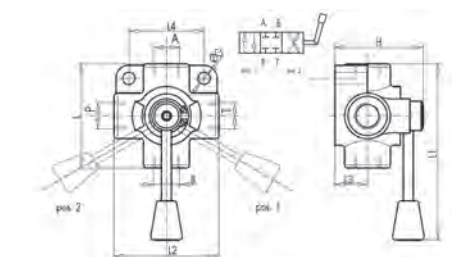

**Desviador de 4 vías. Presión máx. 250 bar** | Vanne agricole 4 voies. Pression max 250 bar | 4 ways flow divider. Max pressure 250 bar | Deviatori di flusso a 4 vie. Pressione max 250 bar

Referencia Part no.	A-B P-T Gas	L (mm)	L1 (mm)	L2 (mm)	L3 (mm)	L4 (mm)	ØG (mm)	H (mm)
D4V38	3/8	76	140	76	26	54	8,5	72
D4V12	1/2	88	145	88	30	65	8,5	82

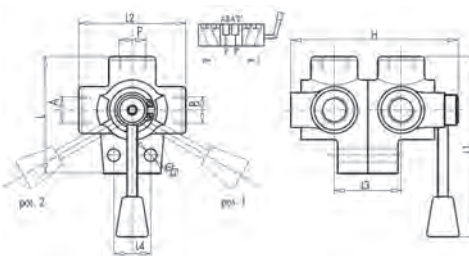

**Desviador de 6 vías. Presión máx. 250 bar** | Vanne agricole 6 voies. Pression max 250 bar | 6 ways flow divider. Max pressure 250 bar | Deviatori di flusso a 6 vie. Pressione max 250 bar

Referencia Part no.	A-B P Gas	L (mm)	L1 (mm)	L2 (mm)	L3 (mm)	L4 (mm)	ØG (mm)	H (mm)
D6V38	3/8	76	140	68	45	26	8,5	117
D6V12	1/2	87	145	80	51	32	8,5	125

## Racores giratorios

Raccords tournants  
Swivel fittings  
Raccordi girevoli

Adaptors

ORFS

Quick-release couplings

Ball valves, diverters

Protections

### Racor giratorio recto



Raccord tournant droit  
Straight swivel fittings  
Raccordo girevole

ROSCA THREAD	REFERENCIA PART N°	€
1/4" BSP	GGL 1/4	25,49
3/8" BSP	GGL 3/8	27,63
1/2" BSP	GGL 1/2	31,65
3/4" BSP	GGL 3/4	50,61
1" BSP	GGL 1	63,83
1" 1/4 BSP	GGL 1 1/4	110,85
1" 1/2 BSP	GGL 1 1/2	169,33
2" BSP	GGL 2	294,85

### Racor giratorio 90°



Raccord tournant coude 90°  
Elbow 90° swivel fitting  
Raccordo girevole a 90°

ROSCA THREAD	REFERENCIA PART N°	€
1/4" BSP	GG90 1/4	27,95
3/8" BSP	GG90 3/8	31,65
1/2" BSP	GG90 1/2	39,36
3/4" BSP	GG90 3/4	67,42
1" BSP	GG90 1	90,61
1" 1/4 BSP	GG90 1 1/4	169,75
1" 1/2 BSP	GG90 1 1/2	282,37
2" BSP	GG90 2	396,27

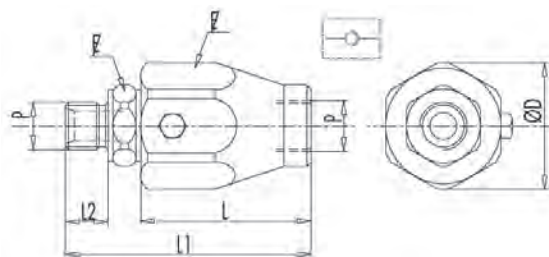

### Racor giratorio recto | Raccord tournant droit | In line rotating coupling | Giunti girevoli in linea

Referencia Part no.	P Gas	Caudal máx. Max flow (lt/min)	Velocidad rot. máx. Max rotate speed (turn/min)	Presión máx. en rot. Máx. rotation press (bar)	Presión máx. Máx pressure (bar)	L (mm)	L1 (mm)	L2 (mm)	E (mm)	E1 (mm)	Ø (mm)
GGL 1/4	1/4	25	212	200	400	42	61	11	19	30	33
GGL 3/8	3/8	35	173	200	400	44	66	14	24	34	37
GGL 1/2	1/2	60	160	150	300	47	71	15	27	36	40
GGL 3/4	3/4	100	120	150	300	50	80	19	34	45	49
GGL 1	1	180	100	100	300	57	90	21	41	50	54,5

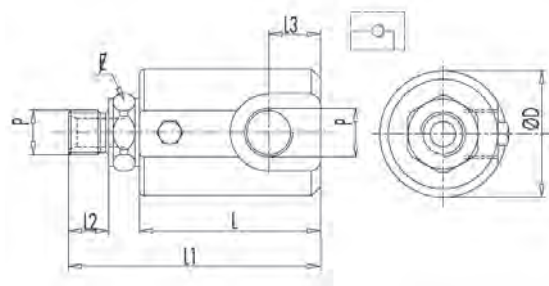

### Racor giratorio codo 90° | Raccord tournant coude 90° | 90° rotating coupling | Giunti girevoli a 90°

Referencia Part no.	P Gas	Caudal máx. Max flow (lt/min)	Velocidad rot. máx. Max rotate speed (turn/min)	Presión máx. en rot. Máx. rotation press (bar)	Presión máx. Máx pressure (bar)	L (mm)	L1 (mm)	L2 (mm)	L3 (mm)	E (mm)	ØD (mm)
GG90 1/4	1/4	25	212	200	400	50	69	11	11	19	34
GG90 3/8	3/8	35	173	200	400	54	76	14	13	24	38
GG90 1/2	1/2	60	160	150	300	63	87	15	14	27	40
GG90 3/4	3/4	100	120	150	300	70	100	19	18	34	55
GG90 1	1	180	100	100	300	80	113	21	25	41	60

Gama de productos. Para más información soliciten nuestros catálogos generales o visiten nuestra página web  
Gamme de produits. Pour plus d'information, nous vous prions de nous demander nos catalogues generaux ou visiter notre web-site  
Products range. For any further information, please, ask for our general catalogues or visit our web-site  
Gamma di Prodotti. Per ulteriori información di ricuidete il nostri cataloghi o visitate la Nostra pagina web

# mangueras

HOSES TUYAUX

# DICSA





# Protecciones

Protections/ressorts

Protections

Protezioni



## ▶ Tapones de plástico

Capuchons plastique | Plastic plugs | Tappi di plastica

Adaptors

- ▶ **Tapones hembra para roscas macho** | Capuchons plastique femelle pour filetage mâle | Female plugs for male thread | Tappi femmina per filettature maschio

297



TFG



TFM



TFU

ORFS

- ▶ **Tapones para bridas** | Capuchons plastique de brides SAE | Plugs for flanges | Tappi per flangia

297



TS 3000



TS 6000

Quick-release couplings

- ▶ **Tapones macho para roscas hembra** | Bouchons plastique mâle pour filetage femelle | Male plugs for female thread | Tappi maschio per filettature femmina

298



TMG



TMM



TMU

Ball valves, diverters

- ▶ **Cinta Teflón** | Ruban Teflon | PTFE Tape | Nastro di teflon

298



M29990

Protections

# Muelles

Ressorts | Springs | Molle

► **Muelles de plástico** | Ressorts plastique | Plastic springs | Molla di plastica

299



AMUELLE P



AMUELLE P



AMUELLE P

► **Muelles metálicos** | Ressorts métalliques | Metallic springs | Molla metallica

300



AMUELLE

## Protecciones textiles

Protection textile | Textile protection | Protezioni tessili

### ▶ Protección textil | Protection textile | Textile protection | Protezioni tessile

301



GT



ABRAZADERA

### ▶ Protección fibra de vidrio | Protection en fibre de verre | Fiberglass protection | Protezione in fibra di vetro

302



AVIDRIO



AVIDRIO S



AVIDRIO FA



ROVISIVE

### ▶ Protección fibra cerámica | Protection en fibre de céramique | Ceramic fiber protection | Protezione in fibra di ceramica

302



ACERAMICA

# Fijaciones de seguridad

Système de sécurité anti-fouet | Safety fixation | Fune di sicurezza

## ▶ Elementos de fijación de seguridad | Système de sécurité anti-fouet | Safety fixation elements | Componenti per fune di sicurezza 304

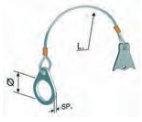

STOPFUDIN  
CONF



STOPFUSAE  
CONF



STOPFA



## Tapones de plástico

Capuchons plastique  
Plastic plugs  
Tappi di plastica

### Tapón hembra rosca BSP



Capuchons plastique femelle - gaz  
Female plug - BSP thread  
Tappo femmina BSP

DN	REFERENCIA PART N°	€
1/8"	TFG 1/8	0,09
1/4"	TFG 1/4	0,10
3/8"	TFG 3/8	0,10
1/2"	TFG 1/2	0,13
5/8"	TFG 5/8	0,14
3/4"	TFG 3/4	0,15
1"	TFG 1	0,23
1"1/4	TFG 1 1/4	0,29
1"1/2	TFG 1 1/2	0,33
2"	TFG 2	0,55

### Tapón hembra rosca Métrica



Capuchons plastique femelle - Métriques  
Female plug - Metric thread  
Tappo femmina Metrico

DN	REFERENCIA PART N°	€
12x1.5	TFM 12X1.5	0,10
14x1.5	TFM 14X1.5	0,11
16x1.5	TFM 16X1.5	0,11
18x1.5	TFM 18X1.5	0,13
20x1.5	TFM 20X1.5	0,13
22x1.5	TFM 22X1.5	0,14
24x1.5	TFM 24X1.5	0,15
26x1.5	TFM 26X1.5	0,15
30x2	TFM 30X2	0,20
36x2	TFM 36X2	0,25
42x2	TFM 42X2	0,29
52x2	TFM 52X2	0,47

### Tapón hembra rosca UNF/ JIC



Capuchons plastique femelle - JIC-UNF  
Female plug - UNF (JIC) thread  
Tappo femmina UNF/JIC

DN	REFERENCIA PART N°	€
7/16"	TFU 7/16	0,09
1/2"	TFU 1/2	0,10
9/16"	TFU 9/16	0,11
3/4"	TFU 3/4	0,13
7/8"	TFU 7/8	0,14
1"1/16	TFU 1 1/16	0,15
1"5/16	TFU 1 5/16	0,23
1"5/8	TFU 1 5/8	0,29
1"7/8	TFU 1 7/8	0,33

### Tapón para bridas 3000 PSI



Capuchons plastique de brides SAE 3000 PSI  
Plugs for 3000 PSI flanges  
Tappo per flangia 3000 PSI

DN	REFERENCIA PART N°	€
30,2	TS 3000 1/2	0,19
38,1	TS 3000 3/4	0,22
44,5	TS 3000 1	0,25
50,8	TS 3000 1 1/4	0,28
60,3	TS 3000 1 1/2	0,32
71,4	TS 3000 2	0,37

### Tapón para bridas 6000 PSI



Capuchons plastique de brides SAE 6000 PSI  
Plugs for 6000 PSI flanges  
Tappo per flangia 6000 PSI

DN	REFERENCIA PART N°	€
31,8	TS 6000 1/2	0,20
41,3	TS 6000 3/4	0,24
47,6	TS 6000 1	0,27
54	TS 6000 1 1/4	0,30
63,5	TS 6000 1 1/2	0,34
79,4	TS 6000 2	0,42



## Tapones de plástico

Capuchons plastique  
Plastic plugs  
Tappi di plastica

Adaptors

ORFS

Quick-release  
couplings

Ball valves, diverters

Protections

### Tapón macho rosca BSP



Bouchons plastique mâle - gaz  
Male plug for BSP thread  
Tappo maschio BSP

DN	REFERENCIA PART N°	€
1/8"	TMG 1/8	0,09
1/4"	TMG 1/4	0,10
3/8"	TMG 3/8	0,12
1/2"	TMG 1/2	0,16
5/8"	TMG 5/8	0,16
3/4"	TMG 3/4	0,19
1"	TMG 1	0,28
1"1/4	TMG 1 1/4	0,43
1"1/2	TMG 1 1/2	0,58
2"	TMG 2	0,63

### Tapón macho rosca Métrica



Bouchons plastique mâle - Métriques  
Male plug for Metric thread  
Tappo maschio Metrico

DN	REFERENCIA PART N°	€
12x1.5	TMM 12X1.5	0,10
14x1.5	TMM 14X1.5	0,11
16x1.5	TMM 16X1.5	0,12
18x1.5	TMM 18X1.5	0,14
20x1.5	TMM 20X1.5	0,15
22x1.5	TMM 22X1.5	0,16
24x1.5	TMM 24X1.5	0,18
26x1.5	TMM 26X1.5	0,19
30x2	TMM 30X2	0,23
36x2	TMM 36X2	0,33
42x2	TMM 42X2	0,43
45x2	TMM 45X2	0,51
52x2	TMM 52X2	0,63

### Tapón macho rosca UNF/ JIC



Bouchons plastique mâle - JIC-UNF  
Male plug for unf (JIC) thread  
Tappo maschio UNF/JIC

DN	REFERENCIA PART N°	€
7/16"	TMU 7/16	0,10
1/2"	TMU 1/2	0,10
9/16"	TMU 9/16	0,11
3/4"	TMU 3/4	0,14
7/8"	TMU 7/8	0,16
1"1/16	TMU 1 1/16	0,19
1"5/16	TMU 1 5/16	0,28
1"5/8	TMU 1 5/8	0,45
1"7/8	TMU 1 7/8	0,58

### Cinta Teflón



Ruban Teflon  
PTFE Tape  
Nastro di teflon

Descripción Description	REFERENCIA PART N°	€
Rollo suelto: 12 mm x 12 mt x 0,076 mm	M299900	0,97
Plástico de 10 rollos	M2999010	8,85
Caja de 200 rollos	M29990200	163,64

## Muelles

Ressorts  
Springs  
Molle

### Muelle de plástico perfil 8x1



Ressort plastique profil 8x1  
Plastic spring profile 8x1  
Molla di plastica 8x1

DN	LONGITUD (M) LENGTH (M)	REFERENCIA PART N°	€
12	50	AMUELLE P12	4,07

### Muelle de plástico perfil 16x1



Ressort plastique profil 16x1  
Plastic spring profile 16x1  
Molla di plastica 16x1

DN	LONGITUD (M) LENGTH (M)	REFERENCIA PART N°	€
15	50	AMUELLE P15	4,69
16	50	AMUELLE P16	4,75
17	50	AMUELLE P17	4,81
18	50	AMUELLE P18	4,89
20	50	AMUELLE P20	4,95
22	50	AMUELLE P22	4,46
25	50	AMUELLE P25	5,92
28	50	AMUELLE P28	6,65
30	50	AMUELLE P30	6,88

### Muelle de plástico perfil 16x2



Ressort plastique profil 16x2  
Plastic spring profile 16x2  
Molla di plastica 16x2

DN	LONGITUD (M) LENGTH (M)	REFERENCIA PART N°	€
33	20	AMUELLE P33	10,64
35	20	AMUELLE P35	10,83
40	20	AMUELLE P40	11,32
45	20	AMUELLE P45	12,83
50	20	AMUELLE P50	13,79
55	20	AMUELLE P55	16,29
60	20	AMUELLE P60	18,23
70	20	AMUELLE P70	22,18
80	20	AMUELLE P80	25,62

#### AMUELLE P15

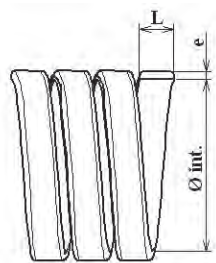

**Dimensiones de los muelles de plástico:**  
Dimensions des ressorts en plastique:  
Dimensions of the plastic springs:  
Dimensioni della molla di plastica:

**L = 16 mm**  
**e = 1 mm**  
**DN = 15 mm**

#### AMUELLE 16

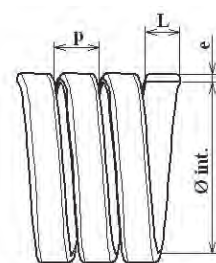

**Dimensiones de los muelles metálicos:**  
Dimensions des ressorts métalliques plats:  
Dimensions of the metallic flat springs:  
Dimensioni della molla metallica piatta:

**L = 5 mm**  
**e = 1 mm**  
**DN = 16 mm**  
**p = 8 mm**

# Muelles

Ressorts  
Springs  
Molle

Adaptors

ORFS

Quick-release  
couplings

Ball valves, diverters

Protections

## Muelle metálico plano perfil 5x1



R ressort métallique plat profil 5x1

Flat metallic spring 5x1

Molla metallica piatta 5x1

DN	REFERENCIA PART N°	€
16	AMUELLE16	9,23
18	AMUELLE18	9,28
20	AMUELLE20	9,44
22	AMUELLE22	10,04
24	AMUELLE24	10,60
26	AMUELLE26	11,10
28	AMUELLE28	12,72
30	AMUELLE30	13,02
32	AMUELLE32	13,22
34	AMUELLE34	13,88
38	AMUELLE38	14,73
40	AMUELLE40	15,24
42	AMUELLE42	16,35
47	AMUELLE47	17,61
52	AMUELLE52	18,32
60	AMUELLE60	20,69
68	AMUELLE68	25,38
72	AMUELLE72	26,59

► Podemos suministrar muelles metálicos redondos en acero galvanizado bajo plano. Consúltenos

Nous pouvons fournir des ressorts métalliques ronds en acier galvanisé sur plan. Consultez-nous.

We can supply rounded metallic springs in galvanized steel under drawing. Please, enquire us.

Possiamo fornire molle metalliche rotonde in acciaio galvanizzato su ordine. Richieda.

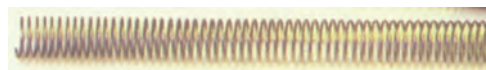
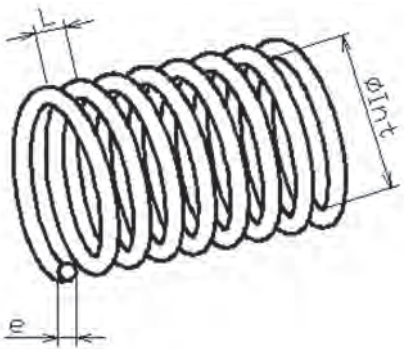

**Datos necesarios para consultar:** | Données nécessaires pour consulter: | Necessary data to enquire: | Dati necessari per l'ordine:

**L = espacio entre alambres** | place entre fils de fer | space between wires | spazio tra

**e = espesor alambre** | wire thickness | épaisseur | spessore

**ø = ø interior del muelle** | ø int. | ø int. wire | interno della molla

**Longitud del muelle** | Longueur du ressort | Spring length | Longhezza della molla

## Protecciones textiles

Protection textile  
Textile protection  
Protezioni tessili

### Tubo de protección textil



Gaine de protection textile  
Textile protection tube  
Tubo di protezioni tessile

Ø in	TAMAÑO SIZE	REFERENCIA PART N°	€
22	35	GT35	1,26
25	40	GT40	1,36
28	45	GT45	1,68
31	50	GT50	1,79
35	55	GT55	1,97
41	65	GT65	2,25
50	80	GT80	2,95
76	120	GT120	3,69
95	150	GT150	9,65



### Accesorios tubo de protección textil



Accessoires pour gaine de protection textile  
Textile protection tube accessories  
Accessori per la protezione dei tessili

Ø int max	Ø int min	REFERENCIA PART N°	€
18	15	ABRAZADERA 15-18	0,63
23	20	ABRAZADERA 20-23	0,83
25	22	ABRAZADERA 22-25	1,07
27	23	ABRAZADERA 23-27	1,20
28	25	ABRAZADERA 25-28	1,07
43	40	ABRAZADERA 40-43	2,50
46	43	ABRAZADERA 43-46	2,37

## Protecciones textiles

Protection textile  
Textile protection  
Protezioni tessili

Adaptors

ORFS

Quick-release couplings

Ball valves, diverters

Protections

### Tubo de fibra de vidrio



Gaine de fibre de verre  
Fiberglass tube  
Tubo di fibra di vetro

L (mm)	Ø int max	Ø int min	REFERENCIA PART N°	€
15	15	12	<b>AVIDRIO 15</b>	<b>3,09</b>
20	18	16	<b>AVIDRIO 20</b>	<b>4,12</b>
25	22	18	<b>AVIDRIO 25</b>	<b>5,15</b>
30	28	25	<b>AVIDRIO 30</b>	<b>6,19</b>
35	32	28	<b>AVIDRIO 35</b>	<b>7,56</b>
40	35	30	<b>AVIDRIO 40</b>	<b>8,25</b>
45	42	38	<b>AVIDRIO 45</b>	<b>9,62</b>
50	48	45	<b>AVIDRIO 50</b>	<b>10,31</b>
60	52	48	<b>AVIDRIO 60</b>	<b>15,12</b>
75	72	70	<b>AVIDRIO 75</b>	<b>19,24</b>

### Tubo de fibra de vidrio siliconado



Gaine de fibre de verre siliconée  
Silicone fiberglass tube  
Tubo di fibra di vetro siliconato

DN	REFERENCIA PART N°	€
12	<b>AVIDRIO S 12</b>	<b>19,39</b>
16	<b>AVIDRIO S 16</b>	<b>21,41</b>
19	<b>AVIDRIO S 19</b>	<b>24,61</b>
28	<b>AVIDRIO S 28</b>	<b>37,29</b>
32	<b>AVIDRIO S 32</b>	<b>39,98</b>
38	<b>AVIDRIO S 38</b>	<b>41,32</b>
51	<b>AVIDRIO S 51</b>	<b>62,73</b>
70	<b>AVIDRIO S 70</b>	<b>124,19</b>

### Tubo de fibra cerámica



Gaine de fibre de céramique  
Ceramic fibre tube  
Tubo in fibra di ceramica

DN	REFERENCIA PART N°	€
15	<b>ACERAMICA 15</b>	<b>7,27</b>
20	<b>ACERAMICA 20</b>	<b>9,13</b>
25	<b>ACERAMICA 25</b>	<b>10,47</b>
30	<b>ACERAMICA 30</b>	<b>14,32</b>
40	<b>ACERAMICA 40</b>	<b>18,98</b>
50	<b>ACERAMICA 50</b>	<b>23,67</b>
60	<b>ACERAMICA 60</b>	<b>28,44</b>
70	<b>ACERAMICA 70</b>	<b>35,52</b>

### Tubo de fibra de vidrio saturada



Gaine de fibre de verre saturée  
Saturated fiberglass tube  
Tubo in fibra di vetro saturato

Ø int max	Ø int min	REFERENCIA PART N°	€
3/4"	1/2"	<b>AVIDRIO FA 08</b>	<b>9,97</b>
1" 3/4	1"	<b>AVIDRIO FA 16</b>	<b>26,73</b>
2" 1/4	1" 1/2	<b>AVIDRIO FA 24</b>	<b>41,17</b>
4"	2" 1/2	<b>AVIDRIO FA 40</b>	<b>65,58</b>

### Revestimiento de fibra de vidrio con velcro



Revêtement de fibre de verre avec velcro  
Fiberglass with velcro shield  
Rivestimento di fibra di vetro con velcro

DN	REFERENCIA PART N°	€
1" 1/2	<b>ROVISIVE 24</b>	<b>107,82</b>
2"	<b>ROVISIVE 32</b>	<b>125,78</b>
2" 3/4	<b>ROVISIVE 44</b>	<b>152,10</b>

## AVIDRIO

Tubo de fibra de vidrio | Fibreglass tube

Fibra de alta calidad tipo E, no se quema y soporta exposiciones a temperaturas de 540 °C. Resiste la mayoría de ácidos y alcalinos y no le afecta la mayoría de disolventes ni lejías/blanqueantes.

High-quality fiber type E, no burns and supports exposure to temperatures of 540 °C. Resists most acids and alkalis and is unaffected by most solvents or bleach.



## AVIDRIO S

Tubo de fibra de vidrio siliconado | Silicone fibreglass tube

Diseñado para proteger mangueras, alambres, etc, de los peligros del calor elevado y de las llamas ocasionales. Protección continua a 260 °C, soporta picos de hasta 1200 °C. Es resistente a fluidos hidráulicos, aceites lubricantes y combustibles. La funda siliconada protege contra la pérdida de energía en tubo rígido y manguera.

Designed to protect hoses, wires and cables from the hazards of high heat on occasional flame. It protects continuously to 260 °C and will withstand a molten splash at 1200 °C. Resistant to hydraulic fluids, lubricating oils and fuels, it insulates against energy loss in piping and hosing.

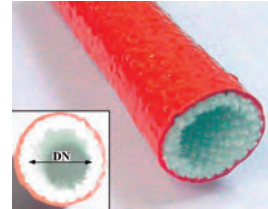

## AVIDRIO FA

Fibra de vidrio saturada | Saturated fibreglass tube

Proporciona protección continua hasta 540 °C. Es resistente a la mayoría de ácidos y alcalinos y no le afectan la mayoría de los disolventes ni lejías/blanqueantes. Es altamente flexible y adaptable, esto que permite que una misma protección pueda colocarse en varios diámetros de tubo, o incluso en montajes ya terminados (manguera/tubo + conexión/rácor). También es muy útil en longitudes largas de manguera o cable.

Provides continuous protection up to 540 °C. It is resistant to most acids and alkalis and is not affected by most of the solvents or bleach. It is highly flexible and adaptable, this allows to place the same protection on various diameters of pipe, or even on already finished assemblies (hose / pipe + connection / fitting). It is also useful in long lengths of hose or cable.

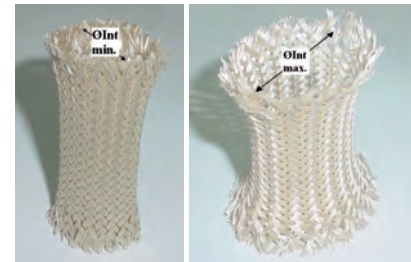

## ROVISIVE

Revestimiento de fibra de vidrio siliconada con velcro | Silicon fibreglass with velcro shield

Diseñado para proteger mangueras, alambres, etc, de los peligros del calor elevado y de las llamas ocasionales. Protección continua a 260 °C, soporta picos de hasta 1200 °C. Su sistema de cierre con velcro permite el montaje in situ sin necesidad de quitar y poner los racores y terminales

Designed to protect hoses, wires and cables from the hazards of high heat on occasional flame. It protects continuously to 260 °C and will withstand a molten splash at 1200 °C. Its Velcro closure system allows application in-situ without the need to dismantle and reconnect fittings and terminations.

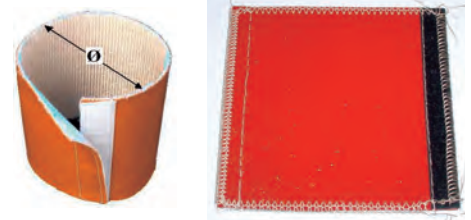

## ACERAMICA

Tubo de fibra cerámica | Ceramic fibre tube

La fibra cerámica está compuesta de silicato de aluminio. Es considerablemente resistente a altas temperaturas y tiene una estabilidad química excelente, resiste a los agentes más corrosivos, con la excepción del ácido fosfórico, ácido clorhídrico y bases fuertes. Tiene una excelente insonorización y aislamiento eléctrico, es de baja densidad y alta flexibilidad. No gotea en caso de incendio (no contiene agua). Sus características térmicas y físicas no se alteran por el agua, vapor o aceite.

Ceramic fibre is composed of aluminium silicate. Is considerably resistant to high temperatures and has excellent chemical stability, resists to most corrosive agents, with the exception of phosphoric acid, hydrochloric acid and strong alkalis. It has excellent sound-proofing and electric insulation, low density and high flexibility. Not dripping in case of fire (does not contain water). Its thermal and physical characteristics are not altered by water, steam or oil.



## Fijaciones de seguridad

Système de sécurité anti-fouet  
Safety fixation  
Fune di sicurezza

Adaptors

ORFS

Quick-release  
couplings

Ball valves, diverters

Protections

### Protección para DIN 2353



Platines de fixation pour DIN 2353  
Retaining system to DIN 2353  
Protezione per DIN 2353

Ø in	REFERENCIA PART N°	€
14.5 mm	STOPFUDIN 145 CONF	21,21
17 mm	STOPFUDIN 17 CONF	21,21
18.5 mm	STOPFUDIN 185 CONF	21,21
20.5 mm	STOPFUDIN 205 CONF	21,21
22.5 mm	STOPFUDIN 225 CONF	21,65
24.5 mm	STOPFUDIN 245 CONF	21,55
26.5 MM	STOPFUDIN 265 CONF	21,55
30.5 mm	STOPFUDIN 305 CONF	22,25
34 mm	STOPFUDIN 34 CONF	25,38
36.5 mm	STOPFUDIN 365 CONF	23,94
42.5 mm	STOPFUDIN 425 CONF	24,34
45.5 mm	STOPFUDIN 455 CONF	23,61
49 mm	STOPFUDIN 49 CONF	25,03
52.5 mm	STOPFUDIN 525 CONF	25,38
60 mm	STOPFUDIN 60 CONF	25,73

### Protección para bridas



Platines de fixation pour brides  
Retaining system for flanges  
Protezione per flangie

Ø in	REFERENCIA PART N°	€
8.5 mm	STOPFUSAE 085 CONF	24,34
10.5 mm	STOPFUSAE 105 CONF	25,03
12.5 mm	STOPFUSAE 125 CONF	25,73
14.5 mm	STOPFUSAE 145 CONF	25,73
16.5 mm	STOPFUSAE 165 CONF	27,81
20.5 mm	STOPFUSAE 205 CONF	26,07

### Abrazaderas



Colliers de fixation stopflex  
Fixation clamps  
Collari fissatubo

Ø in	REFERENCIA PART N°	€
11-11.5 mm	STOPFA11115	6,61
12-12.5 mm	STOPFA12125	6,61
13-13.5 mm	STOPFA13135	6,61
14-15 mm	STOPFA1415	6,56
16-17 mm	STOPFA1617	6,56
17-18 mm	STOPFA1718	6,61
18-19 mm	STOPFA1819	6,61
20-21 mm	STOPFA2021	6,61
21-22 mm	STOPFA2122	6,61
22-23 mm	STOPFA2223	6,61
24-25 mm	STOPFA2425	6,95
25-26 mm	STOPFA2526	6,95
26-27 mm	STOPFA2627	6,95
27-28 mm	STOPFA2728	7,30
28-29 mm	STOPFA2829	7,30
30-31 mm	STOPFA3031	7,30
32-33 mm	STOPFA3233	7,65
34-35 mm	STOPFA3435	8,00
36-37 mm	STOPFA3637	7,54
38-39 mm	STOPFA3839	7,65
39-40 mm	STOPFA3940	7,65
40-41 mm	STOPFA4041	8,00
42-43 mm	STOPFA4243	8,00
43-44 mm	STOPFA4344	7,87
44-45 mm	STOPFA4445	7,87
45-47 mm	STOPFA4547	9,18
48-50 mm	STOPFA4850	10,08
51-53 mm	STOPFA5153	10,08
53-54 mm	STOPFA5354	9,51
54-56 mm	STOPFA5456	9,73
57-59 mm	STOPFA5759	9,73
60-62 mm	STOPFA6062	10,08
63-64 mm	STOPFA6365	10,08
66-68 mm	STOPFA6668	10,43
69-71 mm	STOPFA6971	10,43
72-74 mm	STOPFA7274	10,43
75-77 mm	STOPFA7577	10,43
78-80 mm	STOPFA7880	10,78
81-83 mm	STOPFA8183	10,78
84-86 mm	STOPFA8486	10,78
87-89 mm	STOPFA8789	11,13
90-92 mm	STOPFA9092	11,13
93-95 mm	STOPFA9395	11,47

# Fijaciones de seguridad

Système de sécurité anti-fouet | Safety system | Fune di sicurezza

Referencia   Référence Part No.   Codice	Ø	SP	Recomendado para   Recommandé pour Recommended for   Consigliato per
STOPFUDIN 145 CONF	14,5	2,5	8L - 1/4"
STOPFUDIN 17 CONF	17	2,5	8S - 10L - 3/8"
STOPFUDIN 185 CONF	18,5	2,5	10S - 12L
STOPFUDIN 205 CONF	20,5	2,5	12S
STOPFUDIN 225 CONF	22,5	2,5	14S - 15L - 1/2"
STOPFUDIN 245 CONF	24,5	2,5	16S - 5/8"
STOPFUDIN 265 CONF	26,5	2,5	18L - 3/4"
STOPFUDIN 305 CONF	30,5	3	20S - 22L
STOPFUDIN 34 CONF	34	3	1"
STOPFUDIN 365 CONF	36,5	3	25S - 28L
STOPFUDIN 425 CONF	42,5	3	30S - 1" 1/4
STOPFUDIN 455 CONF	45,5	3	35L
STOPFUDIN 49 CONF	49	3	1" 1/2
STOPFUDIN 525 CONF	52,5	3	38S - 42L
STOPFUDIN 60 CONF	60	3	2"
STOPFUSAE 085 CONF	8,5	4	BRIDA SAE 1/2" 3000 y 6000 PSI
STOPFUSAE 105 CONF	10,5	4	BRIDA SAE 1/2"-1"-1"1/4 3000 PSI y 3/4" 6000 PSI
STOPFUSAE 125 CONF	12,5	4	BRIDA SAE 1"1/2-2" 3000 PSI y 1" 6000 PSI
STOPFUSAE 145 CONF	14,5	4	BRIDA SAE 1"1/4 6000 PSI
STOPFUSAE 165 CONF	16,5	4	BRIDA SAE 1"1/2 6000 PSI
STOPFUSAE 205 CONF	20,5	4	BRIDA SAE 2" 6000 PSI

Adaptors

ORFS

Quick-release  
couplings

Ball valves, diverters

Protections

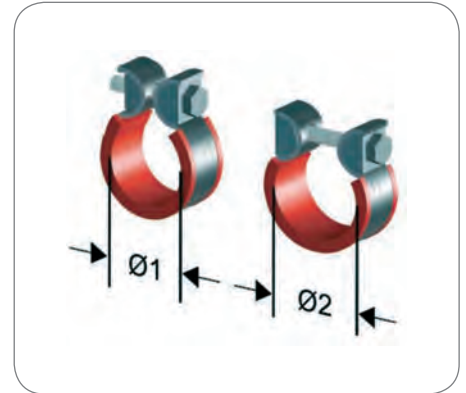



Producción | Production | Production | Fabricazione



Montaje de latiguillos y tubo rígido | Mounting flexibles and pipe |  
Montage de flexibles et tube rigide | Montaggio di tubi flessibili e tubo rigido



Calidad | Quality | Qualité | Qualità

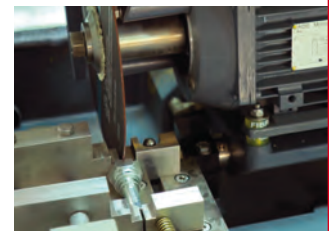



## Tuberías y espirales

Tubes et serpentines  
Pipe and springs  
Tubi e spirali

1

## Racores

Raccords pneumatiques  
Fittings  
Raccordi

2

## Enchufes rápidos neumáticos

Coupleurs pneumatiques  
Quick release couplings  
Innesti rapidi

3

## Elementos industriales - instalación

Éléments industriels - montage  
Industrial elements  
Elementi industriali

4

## Cilindros neumáticos

Vérins pneumatics  
Cylinders  
Cilindri

5

# Tuberías y espirales

Tubes et serpentins

Pipe and springs

Tubi e spirali

# 1

Espirales y tuberías de poliamida y poliuretano

312

Serpentins et tube de polyamide et polyuréthane | Polyamide and polyurethane springs and tube  
| Spirali e tubi in poliammide e poliuretano

## Espirales y tuberías de poliamida y poliuretano

Serpentins et tube de polyamide et polyuréthane | Polyamide and polyurethane springs and tube | Spirali e tubi in poliammide e poliuretano

Pipe

### ▶ Tuberías de poliamida y poliuretano | Tubes de polyamide et polyuréthane | Polyamide and polyurethane tubes | Tubi in poliammide e poliuretano 313



POL...NAT



POL...NE



POL...AZ



PUR...AZ

Fittings

### ▶ PTFE sin malla | PTFE sans tresse | PTFE without braid | PTFE senza maglia 313



M2950

Quick release couplings

### ▶ Espirales de poliamida y poliuretano | Serpentins polyamide y polyuréthane | Polyamide and Polyurethane springs | Spirali in poliammide e poliuretano 314



ESPIRPOL



SPUR



HPUR

Industrial elements

Cylinders

## Espirales y tuberías de poliamida y poliuretano

Serpentins et tube de polyamide et polyuréthane

Polyamide and polyurethane springs and tube

Spirali e tubi in poliammide e poliuretano

### Tuberías Poliamida natural



Tubes polyamide naturelle  
Natural polyamide pipe  
Tubis in Poliammide naturale

TUBO PIPE	LONGITUD (M) LENGTH (M)	REFERENCIA PART N°	€
4x6 mm	25	POL4X6NAT	22,33
6x8 mm	25	POL6X8NAT	32,11
8x10 mm	25	POL8X10NAT	40,43
10x12 mm	25	POL10X12NAT	48,82
4x6 mm	100	POL4X6NAT-100	89,32
6x8 mm	100	POL6X8NAT-100	128,44
8x10 mm	100	POL8X10NAT-100	161,78
10x12 mm	100	POL10X12NAT-100	195,27

### Tuberías Poliamida azul



Tubes polyamide bleu  
Blue polyamide pipe  
Tubis in Poliammide blu

TUBO PIPE	LONGITUD (M) LENGTH (M)	REFERENCIA PART N°	€
4x6 mm	25	POL4X6AZ	41,01
6x8 mm	25	POL6X8AZ	55,84
8x10 mm	25	POL8X10AZ	70,14
10x12 mm	25	POL10X12AZ	88,76

### Tuberías Poliamida negro



Tubes polyamide noir  
Black polyamide pipe  
Tubis in Poliammide nero

TUBO PIPE	LONGITUD (M) LENGTH (M)	REFERENCIA PART N°	€
4x6 mm	25	POL4X6NE	18,10
6x8 mm	25	POL6X8NE	22,33
8x10 mm	25	POL8X10NE	32,11
10x12 mm	25	POL10X12NE	37,65
4x6 mm	100	POL4X6NE-100	72,53
6x8 mm	100	POL6X8NE-100	89,24
8x10 mm	100	POL8X10NE-100	128,36
10x12 mm	100	POL10X12NE-100	150,69

### Tuberías Poliuretano azul



Tubes polyuréthane bleu  
Blue polyurethane pipe  
Tubis in Poliuretano blu

TUBO PIPE	LONGITUD (M) LENGTH (M)	REFERENCIA PART N°	€
2x4 mm	25	PUR2X4AZ	19,99
4x6 mm	25	PUR4X6AZ	28,89
6x8 mm	25	PUR6X8AZ	38,61
8x10 mm	25	PUR8X10AZ	48,18
9x12 mm	25	PUR9X12AZ	77,51
4x6 mm	100	PUR4X6AZ-100	65,78
6x8 mm	100	PUR6X8AZ-100	102,20
8x10 mm	100	PUR6.5X10AZ-100	191,90

### PTFE sin malla



PTFE sans tresse  
PTFE without braid  
PTFE senza maglia

TUBO PIPE	LONGITUD (M) LENGTH (M)	REFERENCIA PART N°	€
2x4	25	M2950204	77,51
4x6	25	M2950406	118,06
6x8	25	M2950608	172,91
2x4	100	M2950204-100	300,51
4x6	100	M2950406-100	462,69
6x8	100	M2950608-100	677,34

## Espirales y tuberías de poliamida y poliuretano

Serpentins et tube de polyamide et polyuréthane

Polyamide and polyurethane springs and tube

Spirali e tubi in poliammide e poliuretano

Pipe

### Espirales poliamida azul



Serpentins polyamide bleu

Blue polyamide springs

Spirali poliuretano blu

TUBO PIPE	L. L.	REFERENCIA PART N°	€
4x6MM	30	<b>ESPIRPOL4X6AZ</b>	<b>45,98</b>
6x8 MM	30	<b>ESPIRPOL6X8AZ</b>	<b>65,37</b>
8x10 MM	30	<b>ESPIRPOL8X10AZ</b>	<b>95,23</b>
10x12MM	30	<b>ESPIRPOL10X12AZ</b>	<b>120,48</b>

Fittings

### Espirales poliuretano con racores



Serpentins polyuréthane avec raccords

Polyurethane springs with fittings

Spirale poliuretano con raccordi

TUBO PIPE	LONGITUD (M) LENGTH (M)	REFERENCIA PART N°	€
4x6 mm	5	<b>HPUR4X6 5</b>	<b>37,36</b>
4x6 mm	7,5	<b>HPUR4X6 7.5</b>	<b>44,24</b>
4x6 mm	10	<b>HPUR4X6 10</b>	<b>47,00</b>
6,5x10 mm	5	<b>HPUR6.5X10 5</b>	<b>19,59</b>
6,5x10 mm	7,5	<b>HPUR6.5X10 7.5</b>	<b>28,11</b>
6,5x10 mm	10	<b>HPUR6.5X10 10</b>	<b>35,19</b>

### Espirales poliuretano sin racores



Serpentins polyuréthane sans raccords

Polyurethane springs without fittings

Spirale poliuretano senza raccordi

TUBO PIPE	LONGITUD (M) LENGTH (M)	REFERENCIA PART N°	€
4x6 MM	5M	<b>SPUR4X6 5</b>	<b>6,55</b>
4x6 MM	7,5M	<b>SPUR4X6 7.5</b>	<b>10,01</b>
4x6 MM	10M	<b>SPUR4X6 10</b>	<b>13,32</b>
6,5x10 MM	5M	<b>SPUR6.5X10 5</b>	<b>14,17</b>
6,5x10 MM	7,5M	<b>SPUR6.5X10 7.5</b>	<b>21,25</b>
6,5x10 MM	10M	<b>SPUR6.5X10 10</b>	<b>28,34</b>

Quick release couplings

Industrial elements

Cylinders



Gama de productos. Para más información soliciten nuestros catálogos generales o visiten nuestra página web  
Gamme de produits. Pour plus d'information, nous vous prions de nous demander nos catalogues généraux ou visiter notre web-site  
Products range. For any further information, please, ask for our general catalogues or visit our web-site  
Gamma di Prodotti. Per ulteriori informazioni di ricidete il nostri cataloghi o visitate la Nostra pagina web

2012



Catálogo de productos  
Catalogue de produits  
Products catalogue  
*Catalogo prodotti*

# DICSA

[www.dicsaes.com](http://www.dicsaes.com)

# Racores

Raccords pneumatiques

**Fittings**

Raccordi



Racordaje tecnopolímero	318
Raccords techno-polymère   Technopolymeric fittings   Raccordatura tecnopolimero	
Racordaje rápido	319
Raccords rapides   Tapared quick couplings   Raccordatura rapida	
Accesorios	320
Accessoires   Accessories   Accessori	

## Racordaje tecnopolímero

Raccords techno-polymère | Technopolymeric fittings | Raccordatura tecnopolimero

Pipe

Fittings

Quick release couplings

Industrial elements

Cylinders

### Racordaje tecnopolímero cónico | Raccords techno-polymères coniques | Technopolymeric tapered fittings | Raccordatura tecnopolimero conica

321



PC



PG/PUC



PCF



SCL



PMM



PL



PR



TAP



PLJ



PH



PLL



PUL



PZA



PUT



PT



PW/PY



PWJ/PYJ



PST



PWT



SCU



PKG



PKD

### Racordaje tecnopolímero cilíndrico | Raccords techno-polymères cylindriques | Technopolymeric BSP fittings | Raccordatura tecnopolimero cilindrica

324



PCCI



PHCI



PLCI



PSTCI



PTCI

### Racordaje tecnopolímero en latón niquelado | Raccords techno-polymères en laiton niquelé | Technopolymeric fittings in nickel-plated brass | Raccordatura tecnopolimero in ottone nichelato

325



50040



50050N



50115



50130



50215



50225



50230



50501



50310



50600

# Racordaje rápido

Raccords rapides | Tapered quick couplings | Raccordatura rapida

## Racordaje rápido cónico | Raccords rapides coniques | Tapered quick couplings | Raccordatura rapida conica

327



1000



1010



1025



1030



1035



1710



1700



1040



1050



1100



1110



1120



1130



1210



1220



1230



1300



51410/51420



1500



1510

## Racordaje rápido cilíndrico | Raccords rapides cylindriques | Cylindric quick couplings | Raccordatura rapida cilindrica

330



1020/1021



1027



1028



1115



1215

▶ **Adaptadores rectos** | Adapteurs droits | Adaptors | Adattatori diritti

332



2000



2020



2040



2080



2010



2030



2070



2050



2090



3000



3010



3060



6090

▶ **Tapones** | Bouchons | Plugs | Tappi

334



3015



3020



3025



3030

▶ **Terminales con espiga** | Embout avec douille | Ends with standpipe | Raccordi ad inserto

334



3040



3050



3055



3045

▶ **Racores en codo** | Raccords coudés | Fittings elbows | Raccordi a 90

335



5000



5010



5020

▶ **Racores en te** | Raccords en té | Fittings tee | Raccordi a T

336



4000



4010



4040



4050

▶ **Racores en cruz y racores en Y** | Raccords en croix et raccords en Y | Cross fittings and Y fittings | Raccordi a croce i raccordi a Y

336



6020



6030



6000

▶ **Tacos aluminio** | Blocs aluminium | Aluminium bock | Blocchi alluminio

337



6040



6047

## Raccordaje tecnopolímero

Raccords techno-polymère  
Technopolymeric fittings  
Raccordatura tecnopolimero

### Automático directo macho



Piquage droit mâle  
Straight male  
Automatico diritto maschio

TUBO PIPE	ROSCA THREAD	REFERENCIA PART N°	€
4 mm	1/8"	PC 0401	0,80
4 mm	1/4"	PC 0402	0,83
4 mm	M5	PC 04M5	0,80
6 mm	1/8"	PC 0601	0,82
6 mm	1/4"	PC 0602	0,91
6 mm	3/8"	PC 0603	1,29
8 mm	1/8"	PC 0801	0,89
8 mm	1/4"	PC 0802	0,92
8 mm	3/8"	PC 0803	1,32
10 mm	1/4"	PC 1002	1,35
10 mm	3/8"	PC 1003	1,35
10 mm	1/2"	PC 1004	2,17
12 mm	1/4"	PC 1202	1,89
12 mm	3/8"	PC 1203	1,89
12 mm	1/2"	PC 1204	2,17

### Microregulador para cilindro



Microrégulateur pour vérins  
Elbow speed controller  
Microregolatore per cilindro

TUBO PIPE	ROSCA THREAD	REFERENCIA PART N°	€
4 mm	1/8"	SCL 0401	3,75
4 mm	1/4"	SCL 0402	3,75
4 mm	M5	SCL 04M5	3,75
6 mm	1/8"	SCL 0601	3,75
6 mm	1/4"	SCL 0602	3,75
6 mm	3/8"	SCL 0603	5,36
6 mm	M5	SCL 06M5	3,75
8 mm	1/8"	SCL 0801	3,75
8 mm	1/4"	SCL 0802	3,75
8 mm	3/8"	SCL 0803	5,36
10 mm	1/4"	SCL 1002	4,53
10 mm	3/8"	SCL 1003	8,66
12 mm	1/4"	SCL 1202	8,14
12 mm	3/8"	SCL 1203	14,57
12 mm	1/2"	SCL 1204	19,47

### Automático intermedio



Union à piquage  
Straight union  
Automatico intermedio

TUBO PIPE	REFERENCIA PART N°	€
6 - 4 mm	PG 0604	0,83
8 - 6 mm	PG 0806	1,12
10 - 8 mm	PG 1008	1,24
12 - 10 mm	PG 1210	1,63
4 mm	PUC 04	0,72
6 mm	PUC 06	0,80
8 mm	PUC 08	0,87
10 mm	PUC 10	1,01
12 mm	PUC 12	1,17

### Automático intermedio pasatabique



Piquage passe-cloison  
Bulkhead union  
Automatico intermedio passaparete

TUBO PIPE	REFERENCIA PART N°	€
4 mm	PMM 04	3,12
6 mm	PMM 06	2,69
8 mm	PMM 08	2,62
10 mm	PMM 10	3,61
12 mm	PMM 12	8,21

### Automático codo giratorio macho



Equerre à piquage mâle tournant  
Male elbow  
Automatico maschio girevole

TUBO PIPE	ROSCA THREAD	REFERENCIA PART N°	€
4 mm	1/8"	PL 0401	0,96
4 mm	1/4"	PL 0402	0,96
4 mm	M5	PL 04M5	0,96
6 mm	1/8"	PL 0601	0,96
6 mm	1/4"	PL 0602	1,14
6 mm	3/8"	PL 0603	1,40
8 mm	1/8"	PL 0801	1,20
8 mm	1/4"	PL 0802	1,20
8 mm	3/8"	PL 0803	1,37
10 mm	1/4"	PL 1002	1,42
10 mm	3/8"	PL 1003	1,49
10 mm	1/2"	PL 1004	2,38
12 mm	3/8"	PL 1203	2,32
12 mm	1/2"	PL 1204	2,44

### Automático directo hembra



Piquage droit femelle  
Straight female  
Automatico diritto femmina

TUBO PIPE	ROSCA THREAD	REFERENCIA PART N°	€
4 mm	1/8"	PCF 0401	1,20
6 mm	1/8"	PCF 0601	1,20
6 mm	1/4"	PCF 0602	1,23
8 mm	1/8"	PCF 0801	1,20
8 mm	1/4"	PCF 0802	1,25
10 mm	1/4"	PCF 1002	1,47
12 mm	3/8"	PCF 1203	2,20

## Racordaje tecnopolímero

Raccords techno-polymère  
Technopolymeric fittings  
Raccordatura tecnopolimero

Pipe

Fittings

Quick release couplings

Industrial elements

Cylinders

### Automático de reducción insertable



Piquage de réduction  
Plug in reducer  
Automatico di riduzione

TUBO PIPE	REFERENCIA PART N°	€
6 - 4 mm	PR 0604	1,33
8 - 4 mm	PR 0804	1,44
8 - 6 mm	PR 0806	1,44
10 - 6 mm	PR 1006	1,59
10 - 8 mm	PR 1008	1,62
12 - 8 mm	PR 1208	1,91
12 - 10 mm	PR 1210	1,91

### Automático tapón



Piquage bouchon  
Plug  
Automatico tappo

TUBO PIPE	REFERENCIA PART N°	€
4 mm	TAP 04	0,65
6 mm	TAP 06	0,80
8 mm	TAP 08	0,60
10 mm	TAP 10	1,25
12 mm	TAP 12	1,20

### Automático codo insertable



Coude à piquage lisse  
Plug-in elbow  
Automatico estremita tubolare

TUBO PIPE	REFERENCIA PART N°	€
4 mm	PLJ 04	2,20
6 mm	PLJ 06	2,13
8 mm	PLJ 08	2,20
10 mm	PLJ 10	2,74
12 mm	PLJ 12	3,04

### Automático codo orientable



Banjo simple à piquage mâle  
Male banjo  
Automatico estremita tubolare a 90

TUBO PIPE	ROSCA THREAD	REFERENCIA PART N°	€
4 mm	1/8"	PH 0401	3,65
6 mm	1/8"	PH 0601	3,65
6 mm	1/4"	PH 0602	3,98
8 mm	1/8"	PH 0801	3,72
8 mm	1/4"	PH 0802	4,22
8 mm	3/8"	PH 0803	5,10
10 mm	1/4"	PH 1002	6,11
10 mm	3/8"	PH 1003	6,46

### Automático codo giratorio prolongado



Equerre prolongée à piquage mâle  
Extended male banjo  
Automatico a 90 prolunga maschio girevole

TUBO PIPE	ROSCA THREAD	REFERENCIA PART N°	€
4 mm	1/8"	PLL 0401	2,01
4 mm	1/4"	PLL 0402	2,07
6 mm	1/8"	PLL 0601	2,72
6 mm	1/4"	PLL 0602	3,05
8 mm	1/8"	PLL 0801	2,26
8 mm	1/4"	PLL 0802	2,82
8 mm	3/8"	PLL 0803	3,34
10 mm	1/4"	PLL 1002	3,98

### Automático codo intermedio



Coude d'union à piquage  
Union elbow  
Automatico intermedio a 90

TUBO PIPE	REFERENCIA PART N°	€
4 mm	PUL 04	0,72
6 mm	PUL 06	0,80
8 mm	PUL 08	0,87
10 mm	PUL 10	1,01
12 mm	PUL 12	1,17

### Automático en cruz intermedio



Croix à piquage  
Union cross  
Automatico intermedio a croce

TUBO PIPE	REFERENCIA PART N°	€
4 mm	PZA 04	1,77
6 mm	PZA 06	1,93
8 mm	PZA 08	2,05
10 mm	PZA 10	3,83
12 mm	PZA 12	4,23

### Automático T intermedio



Piquage en Té intermédiaire  
Union tee  
Automatico T intermedio

TUBO PIPE	REFERENCIA PART N°	€
4 mm	PUT 04	1,54
6 mm	PUT 06	0,89
8 mm	PUT 08	0,99
10 mm	PUT 10	1,47
12 mm	PUT 12	2,10



## Racordaje tecnopolímero

Raccords techno-polymère  
Technopolymeric fittings  
Raccordatura tecnopolimero

### Automático T central giratorio



Té à piquage mâle central tournant  
Male branch tee  
Automatico T maschio girevole centrale

TUBO PIPE	ROSCA THREAD	REFERENCIA PART N°	€
4 mm	1/8"	PT 0401	1,72
6 mm	1/8"	PT 0601	1,81
6 mm	1/4"	PT 0602	1,81
8 mm	1/8"	PT 0801	2,03
8 mm	1/4"	PT 0802	2,03
10 mm	1/4"	PT 1002	2,03
10 mm	3/8"	PT 1003	2,53
12 mm	3/8"	PT 1203	2,78
12 mm	1/2"	PT 1204	3,06

### Automático T lateral giratorio



Té à piquage mâle latéral tournant  
Male run tee  
Automatico T maschio girevole laterale

TUBO PIPE	ROSCA THREAD	REFERENCIA PART N°	€
4 mm	1/8"	PST 0401	2,12
6 mm	1/8"	PST 0601	1,69
6 mm	1/4"	PST 0602	1,69
8 mm	1/8"	PST 0801	1,91
8 mm	1/4"	PST 0802	3,60
10 mm	1/4"	PST 1002	4,74
10 mm	3/8"	PST 1003	5,13
12 mm	3/8"	PST 1203 **	2,59
12 mm	1/2"	PST 1204	2,86

\*\* Hasta fin de existencias // Jusqu'à la fin du stock // Until end of stock // Fino ad esaurimento scorta

### Automático Y intermedio



Piquage en Y  
Union Y  
Automatico intermedio a Y

TUBO PIPE	REFERENCIA PART N°	€
8 - 6 mm	PW 0806 **	4,61
12 - 10 mm	PW 1210	6,86
4 mm	PY 04	0,98
6 mm	PY 06	0,98
8 mm	PY 08	1,01
10 mm	PY 10	1,49
12 mm	PY 12	1,68

\*\* Hasta fin de existencias // Jusqu'à la fin du stock // Until end of stock // Fino ad esaurimento scorta

### Automático Y giratorio central



Piquage en Y simple mâle  
Male Y  
Automatico automatico a Y maschio girevole centrale

TUBO PIPE	ROSCA THREAD	REFERENCIA PART N°	€
4 mm	1/8"	PWT 0401	2,55
4 mm	1/4"	PWT 0402	2,68
4 mm	M5	PWT 04M5	1,98
6 mm	1/8"	PWT 0601	2,93
6 mm	1/4"	PWT 0602	3,44
8 mm	1/8"	PWT 0801	3,51
8 mm	1/4"	PWT 0802	3,56
10 mm	1/4"	PWT 1002	5,03
10 mm	3/8"	PWT 1003	5,22
12 mm	3/8"	PWT 1203	6,48
12 mm	1/2"	PWT 1204	8,02

### Automático Y insertable central



Piquage en Y simple lisse  
Plug-in reducer Y  
Automatico a Y estremita tubolare centrale

TUBO PIPE	REFERENCIA PART N°	€
6 - 4 mm	PWJ 0604	1,56
8 - 6 mm	PWJ 0806	2,37
10 - 8 mm	PWJ 1008	2,99
12 - 10 mm	PWJ 1210	3,79
4 mm	PYJ 04	1,86
6 mm	PYJ 06	2,25
8 mm	PYJ 08	2,53
10 mm	PYJ 10	2,89
12 mm	PYJ 12	3,11

### Regulador de caudal en línea



Régulateur de débit en ligne  
Union straight speed controller  
Regolatore di flusso in linea

TUBO PIPE	REFERENCIA PART N°	€
4 mm	SCU 04	4,70
6 mm	SCU 06	4,79
8 mm	SCU 08	5,11
10 mm	SCU 10	7,23

## Racordaje tecnopolímero

Raccords techno-polymère  
Technopolymeric fittings  
Raccordatura tecnopolimero

Pipe

Fittings

Quick release couplings

Industrial elements

Cylinders

### Automático salida múltiple intermedio



Piquage multiple

Reducer triple branch union

Automatico intermedio con uscite multiple

TUBO PIPE	REFERENCIA PART N°	€
6 - 4 mm	PKG 0604	5,07
8 - 4 mm	PKG 0804	5,38
8 - 6 mm	PKG 0806	5,70
10 - 6 mm	PKG 1006	6,05
10 - 8 mm	PKG 1008	6,07

### Automático salida múltiple



Piquage multiple mâle en bout

Male reducer triple branch

Automatico maschio con uscite multiple

TUBO PIPE	ROSCA THREAD	REFERENCIA PART N°	€
6 - 4 mm	1/8"	PKD 060401	3,56
8 - 4 mm	1/4"	PKD 080402	3,92
8 - 6 mm	1/4"	PKD 080602	5,37
10 - 8 mm	3/8"	PKD 100803	5,86

### Automático directo macho



Piquage droit mâle cylindrique

Male straight

Automatico diritto maschio

TUBO PIPE	ROSCA THREAD	REFERENCIA PART N°	€
4 mm	1/8"	PCCI 0401	0,92
4 mm	1/4"	PCCI 0402	0,99
4 mm	M5	PCCI 04M5	0,92
6 mm	1/8"	PCCI 0601	0,99
6 mm	1/4"	PCCI 0602	0,99
6 mm	3/8"	PCCI 0603	1,56
8 mm	1/8"	PCCI 0801	0,99
8 mm	1/4"	PCCI 0802	1,06
8 mm	3/8"	PCCI 0803	1,56
10 mm	1/4"	PCCI 1002	1,56
10 mm	3/8"	PCCI 1003	1,63
10 mm	1/2"	PCCI 1004	2,48
12 mm	1/4"	PCCI 1202	1,84
12 mm	3/8"	PCCI 1203	2,20
12 mm	1/2"	PCCI 1204	2,48

### Automático codo giratorio



Equerre à piquage mâle tournant

Male elbow

Automatico maschio a 90 girevole

TUBO PIPE	ROSCA THREAD	REFERENCIA PART N°	€
4 mm	1/8"	PLCI 0401	1,28
4 mm	1/4"	PLCI 0402	1,28
4 mm	M5	PLCI 04M5	1,28
6 mm	1/8"	PLCI 0601	1,28
6 mm	1/4"	PLCI 0602	1,49
6 mm	3/8"	PLCI 0603	1,63
6 mm	M5	PLCI 06M5	1,28
8 mm	1/8"	PLCI 0801	1,49
8 mm	1/4"	PLCI 0802	1,70
8 mm	3/8"	PLCI 0803	1,70
10 mm	1/4"	PLCI 1002	1,70
10 mm	3/8"	PLCI 1003	1,84
10 mm	1/2"	PLCI 1004	2,91
12 mm	1/4"	PLCI 1202	2,76
12 mm	3/8"	PLCI 1203	2,91
12 mm	1/2"	PLCI 1204	3,12

### Automático codo orientable



Banjo simple à piquage mâle

Male banjo

Automatico orientable a 90

TUBO PIPE	ROSCA THREAD	REFERENCIA PART N°	€
4 mm	1/8"	PHCI 0401	3,87
4 mm	M5	PHCI 04M5	4,71
6 mm	1/8"	PHCI 0601	3,93
6 mm	1/4"	PHCI 0602	4,30
8 mm	1/8"	PHCI 0801	4,01
8 mm	1/4"	PHCI 0802	4,35
8 mm	3/8"	PHCI 0803	6,97
10 mm	1/4"	PHCI 1002	4,47
10 mm	3/8"	PHCI 1003	7,04

### Automático T lateral giratorio



Té à piquage mâle tournant latéral

Male run tee

Automatico T girevole laterale

TUBO PIPE	ROSCA THREAD	REFERENCIA PART N°	€
4 mm	1/8"	PSTCI 0401	3,20
6 mm	1/8"	PSTCI 0601	3,95
6 mm	1/4"	PSTCI 0602	4,70
8 mm	1/8"	PSTCI 0801	4,91
8 mm	1/4"	PSTCI 0802	5,09
10 mm	1/4"	PSTCI 1002	6,70
10 mm	3/8"	PSTCI 1003	6,45
12 mm	3/8"	PSTCI 1203	8,35

## Racordaje tecnopolímero

Raccords techno-polymère  
Technopolymeric fittings  
Raccordatura tecnopolimero

### Automático T central giratorio



Té à piquage mâle tournant central

Male branch tee

Automatico T girevole centrale

TUBO PIPE	ROSCA THREAD	REFERENCIA PART N°	€
4 mm	1/8"	PTCI 0401	2,40
6 mm	1/8"	PTCI 0601	3,23
6 mm	1/4"	PTCI 0602	3,64
8 mm	1/8"	PTCI 0801	2,70
8 mm	1/4"	PTCI 0802	3,33
8 mm	3/8"	PTCI 0803	3,98
10 mm	1/4"	PTCI 1002	4,71
10 mm	3/8"	PTCI 1003	4,84
12 mm	3/8"	PTCI 1203	4,62

### Automático intermedio



Union simple à piquage

Straight union

Automatico intermedio

TUBO PIPE	REFERENCIA PART N°	€
4 mm	50040 4	2,32
6 mm	50040 6	2,52
8 mm	50040 8	3,39
10 mm	50040 10	4,68
12 mm	50040 12	6,50

### Automático codo macho cilíndrico giratorio



Equerre à piquage mâle cylindrique

BSP Male elbow

Automatico a 90 maschio girevole

TUBO PIPE	ROSCA THREAD	REFERENCIA PART N°	€
4 mm	1/8"	50115 4 1/8	3,92
4 mm	M5	50115 4 M5	3,97
6 mm	1/8"	50115 6 1/8	4,00
6 mm	1/4"	50115 6 1/4	4,30
6 mm	M5	50115 6 M5	3,97
8 mm	1/8"	50115 8 1/8	4,59
8 mm	1/4"	50115 8 1/4	4,78
8 mm	3/8"	50115 8 3/8	6,01
10 mm	1/4"	50115 10 1/4	6,04
10 mm	3/8"	50115 10 3/8	6,84
10 mm	1/2"	50115 10 1/2	7,53
12 mm	3/8"	50115 12 3/8	7,69
12 mm	1/2"	50115 12 1/2	8,67

### Automático intermedio pasatabique



Piquage passe-cloison

Bulkhead union

Automatico intermedio passaparete

TUBO PIPE	REFERENCIA PART N°	€
4 mm	50050N 4	5,45
6 mm	50050N 6	6,08
8 mm	50050N 8	6,84
10 mm	50050N 10	8,93
12 mm	50050N 12	10,79

### Automático codo intermedio



Coude d'union à piquage

Male elbow

Automatico a 90 intermedio

TUBO PIPE	REFERENCIA PART N°	€
4 mm	50130 4	3,97
6 mm	50130 6	4,03
8 mm	50130 8	4,70
10 mm	50130 10	5,83
12 mm	50130 12	7,63

## Racordaje tecnopolímero

Raccords techno-polymère  
Technopolymeric fittings  
Raccordatura tecnopolimero

Pipe

Fittings

Quick release  
couplings

Industrial elements

Cylinders

### Automático te central giratoria macho cilíndrico



Té à piquage mâle cylindrique central  
BSP Male branch  
Automatico a T maschio girevole centrale

TUBO PIPE	ROSCA THREAD	REFERENCIA PART N°	€
4 mm	1/8"	50215 4 1/8	5,54
4 mm	1/4"	50215 4 1/4	6,11
6 mm	1/8"	50215 6 1/8	5,56
6 mm	1/4"	50215 6 1/4	5,91
8 mm	1/8"	50215 8 1/8	6,78
8 mm	1/4"	50215 8 1/4	6,93
10 mm	1/4"	50215 10 1/4	8,98
10 mm	3/8"	50215 10 3/8	9,63
12 mm	3/8"	50215 12 3/8	10,40
12 mm	1/2"	50215 12 1/2	11,59

### Automático orientable



Banjo simple à piquage  
Male banjo  
Automatico orientable

TUBO PIPE	ROSCA THREAD	REFERENCIA PART N°	€
4 mm	1/8"	50501 4 1/8	3,22
4 mm	M5	50501 4 M5	3,11
6 mm	1/8"	50501 6 1/8	3,36
6 mm	1/4"	50501 6 1/4	3,63
6 mm	M5	50501 6 M5	3,22
8 mm	1/8"	50501 8 1/8	3,76
8 mm	1/4"	50501 8 1/4	3,92
8 mm	3/8"	50501 8 3/8	4,43
10 mm	1/4"	50501 10 1/4	4,46
10 mm	3/8"	50501 10 3/8	4,87
12 mm	3/8"	50501 12 3/8	6,18

### Automático te lateral giratoria macho cilíndrico



Té à piquage mâle cylindrique latéral  
BSP Male run  
Automatico a T maschio girevole laterale

TUBO PIPE	ROSCA THREAD	REFERENCIA PART N°	€
4 mm	1/8"	50225 4 1/8	5,71
6 mm	1/8"	50225 6 1/8	5,76
6 mm	1/4"	50225 6 1/4	6,11
8 mm	1/8"	50225 8 1/8	6,96
8 mm	1/4"	50225 8 1/4	7,07
10 mm	1/4"	50225 10 1/4	9,34
10 mm	3/8"	50225 10 3/8	9,63
12 mm	3/8"	50225 12 3/8	10,40

### Automático Y intermedio



Piquage en Y  
Union Y  
Automatico a Y intermedio

TUBO PIPE	REFERENCIA PART N°	€
4 mm	50310 4	7,56
6 mm	50310 6	7,95
8 mm	50310 8	9,01

### Automático T intermedia



Té à piquage  
Union tee  
Automatico a T intermedio

TUBO PIPE	REFERENCIA PART N°	€
4 mm	50230 4	5,43
6 mm	50230 6	5,77
8 mm	50230 8	6,66
10 mm	50230 10	8,67
12 mm	50230 12	10,75

### Adaptador macho cilíndrico



Adapteur mâle cylindrique  
Nipple  
Adattatore maschio cilindrico

TUBO PIPE	ROSCA THREAD	REFERENCIA PART N°	€
4 mm	1/8"	50600 4 1/8	1,13
6 mm	1/8"	50600 6 1/8	1,13
6 mm	1/4"	50600 6 1/4	1,40
8 mm	1/8"	50600 8 1/8	1,13
8 mm	1/4"	50600 8 1/4	1,40
8 mm	3/8"	50600 8 3/8	1,97
10 mm	1/4"	50600 10 1/4	1,48
10 mm	3/8"	50600 10 3/8	2,03
12 mm	1/4"	50600 12 1/4	1,77
12 mm	3/8"	50600 12 3/8	2,08

## Racordaje rápido

Raccords rapides  
Tapered quick couplings  
Raccordatura rapida

### Recto cónico macho



Raccord droit mâle conique  
Straight male adaptor tapered  
Raccordo maschio conico

TUBO PIPE	ROSCA THREAD	REFERENCIA PART N°	€
4/2,7 mm	1/8"	1000 4/2.7 1/8	1,51
6/4 mm	1/8"	1000 6/4 1/8	1,34
6/4 mm	1/4"	1000 6/4 1/4	1,59
6/4 mm	3/8"	1000 6/4 3/8	2,05
8/6 mm	1/8"	1000 8/6 1/8	1,56
8/6 mm	1/4"	1000 8/6 1/4	1,69
8/6 mm	3/8"	1000 8/6 3/8	2,23
8/6 mm	1/2"	1000 8/6 1/2	3,04
10/8 mm	1/4"	1000 10/8 1/4	1,95
10/8 mm	3/8"	1000 10/8 3/8	2,41
10/8 mm	1/2"	1000 10/8 1/2	3,39
12/10 mm	3/8"	1000 12/10 3/8	2,79
12/10 mm	1/2"	1000 12/10 1/2	3,74

### Recto hembra



Raccord droit femelle  
Straight female adaptor  
Raccordo femmina

TUBO PIPE	ROSCA THREAD	REFERENCIA PART N°	€
6/4 mm	1/8"	1030 6/4 1/8	1,56
6/4 mm	1/4"	1030 6/4 1/4	1,98
6/4 mm	3/8"	1030 6/4 3/8	3,04
8/6 mm	1/8"	1030 8/6 1/8	1,66
8/6 mm	1/4"	1030 8/6 1/4	2,12
8/6 mm	3/8"	1030 8/6 3/8	2,98
8/6 mm	1/2"	1030 8/6 1/2	3,39
10/8 mm	1/4"	1030 10/8 1/4	2,40
10/8 mm	3/8"	1030 10/8 3/8	3,30
10/8 mm	1/2"	1030 10/8 1/2	4,17
12/10 mm	3/8"	1030 12/10 3/8	4,70

### Recto giratorio cónico macho



Raccord droit mâle tournant conique  
Orienting straight male adaptor tapered  
Raccordo maschio conico girevole

TUBO PIPE	ROSCA THREAD	REFERENCIA PART N°	€
6/4 mm	1/8"	1010 6/4 1/8	3,07
6/4 mm	1/4"	1010 6/4 1/4	3,33
8/6 mm	1/8"	1010 8/6 1/8	3,25
8/6 mm	1/4"	1010 8/6 1/4	3,57
10/8 mm	1/4"	1010 10/8 1/4	4,03
12/8 mm	3/8"	1010 12/8 3/8	5,54
12/10 mm	3/8"	1010 12/10 3/8	5,54

### Recto cónico macho con muelle



Raccord droit mâle conique avec ressort  
Straight male adaptor tapered + nut and spring  
Raccordo maschio conico+molla

TUBO PIPE	ROSCA THREAD	REFERENCIA PART N°	€
6/4 mm	1/8"	1025 6/4 1/8	2,75
6/4 mm	1/4"	1025 6/4 1/4	2,93
8/6 mm	1/8"	1025 8/6 1/8	2,87
8/6 mm	1/4"	1025 8/6 1/4	2,96
8/6 mm	3/8"	1025 8/6 3/8	3,43
8/6 mm	1/2"	1025 8/6 1/2	4,49
10/8 mm	1/8"	1025 10/8 1/8	3,36
10/8 mm	1/4"	1025 10/8 1/4	3,39
10/8 mm	3/8"	1025 10/8 3/8	3,92
10/8 mm	1/2"	1025 10/8 1/2	4,95
12/10 mm	3/8"	1025 12/10 3/8	4,63
12/10 mm	1/2"	1025 12/10 1/2	5,54

### Recto hembra con muelle



Raccord droit femelle avec ressort  
Straight female adaptor tapered+ nut and spring  
Raccordo femmina+molla

TUBO PIPE	ROSCA THREAD	REFERENCIA PART N°	€
6/4 mm	1/8"	1035 6/4 1/8	2,90
6/4 mm	1/4"	1035 6/4 1/4	3,28
6/4 mm	3/8"	1035 6/4 3/8	4,11
8/6 mm	1/8"	1035 8/6 1/8	3,04
8/6 mm	1/4"	1035 8/6 1/4	3,54
8/6 mm	3/8"	1035 8/6 3/8	4,49
8/6 mm	1/2"	1035 8/6 1/2	5,05
10/8 mm	1/4"	1035 10/8 1/4	4,00
10/8 mm	3/8"	1035 10/8 3/8	4,67
10/8 mm	1/2"	1035 10/8 1/2	5,31
12/10 mm	3/8"	1035 12/10 3/8	5,69

### Tuerca de fijación con muelle



Vis de fixation avec ressort  
Locking nut with spring  
Dado di fissaggio con molla

TUBO PIPE	REFERENCIA PART N°	€
6/4 mm	1710 6/4	1,83
8/6 mm	1710 8/6	2,08
10/8 mm	1710 10/8	2,23
12/10 mm	1710 12/10	3,11

## Racordaje rápido

Raccords rapides  
Tapered quick couplings  
Raccordatura rapida

Pipe

### Tuerca de fijación



Vis de fixation  
Locking nut  
Dado di fissaggio

TUBO PIPE	REFERENCIA PART N°	€
4/2,7 mm	1700 4/2.7	0,43
6/4 mm	1700 6/4	0,46
8/6 mm	1700 8/6	0,57
10/8 mm	1700 10/8	0,75
12/10 mm	1700 12/10	0,99

Fittings

### Codo cónico macho



Raccord coudé mâle conique  
Elbow male adaptor tapered  
Raccordo a 90 maschio conico

TUBO PIPE	ROSCA THREAD	REFERENCIA PART N°	€
4/2,7 mm	1/8"	1100 4/2.7 1/8	2,75
6/4 mm	1/8"	1100 6/4 1/8	2,02
6/4 mm	1/4"	1100 6/4 1/4	2,15
6/4 mm	3/8"	1100 6/4 3/8	2,87
8/6 mm	1/8"	1100 8/6 1/8	2,18
8/6 mm	1/4"	1100 8/6 1/4	2,40
8/6 mm	3/8"	1100 8/6 3/8	2,72
8/6 mm	1/2"	1100 8/6 1/2	5,16
10/8 mm	1/4"	1100 10/8 1/4	2,90
10/8 mm	3/8"	1100 10/8 3/8	3,30
10/8 mm	1/2"	1100 10/8 1/2	5,05
12/10 mm	3/8"	1100 12/10 3/8	4,09
10/12 mm	1/2"	1100 12/10 1/2	5,54

### Intermedio



Raccord intermédiaire  
Straight connector  
Raccordo intermedio

TUBO PIPE	REFERENCIA PART N°	€
4/2,7 mm	1040 4/2.7	2,58
6/4 mm	1040 6/4	2,40
8/6 mm - 6/4 mm	1040 8/6 6/4	2,61
8/6 mm	1040 8/6	2,66
10/8 mm - 6/4 mm	1040 10/8 6/4	3,54
10/8 mm - 8/6 mm	1040 10/8 8/6	3,74
10/8 mm	1040 10/8	3,50
12/10 mm	1040 12/10	5,66

Quick release couplings

Industrial elements

### Codo giratorio cónico macho



Raccord coudé tournant mâle conique  
Orienting elbow male adaptor tapered  
Raccordo a 90 maschio conico girevole

TUBO PIPE	ROSCA THREAD	REFERENCIA PART N°	€
4/2,7 mm	1/8"	1110 4/2.7 1/8	3,42
6/4 mm	1/8"	1110 6/4 1/8	3,42
6/4 mm	1/4"	1110 6/4 1/4	3,95
8/6 mm	1/8"	1110 8/6 1/8	3,65
8/6 mm	1/4"	1110 8/6 1/4	4,09
10/8 mm	1/4"	1110 10/8 1/4	4,70

Cylinders

### Pasatabiques



Raccord passe-cloison  
Bulkhead connector  
Raccordo passaparete

TUBO PIPE	REFERENCIA PART N°	€
4/2,7 mm	1050 4/2.7	3,97
6/4 mm	1050 6/4	4,11
8/6 mm - 6/4 mm	1050 8/6X6/4	4,73
8/6 mm	1050 8/6	4,73
10/8 mm - 6/4 mm	1050 10/8X6/4	5,65
10/8 mm - 8/6 mm	1050 10/8X8/6	5,65
10/8 mm	1050 10/8	5,37
12/10 mm	1050 12/10	6,23

### Codo hembra



Raccord coudé femelle  
Elbow female adaptor  
Raccordo a 90 femmina fissa

TUBO PIPE	ROSCA THREAD	REFERENCIA PART N°	€
6/4 mm	1/8"	1120 6/4 1/8	2,31
6/4 mm	1/4"	1120 6/4 1/4	2,82
8/6 mm	1/8"	1120 8/6 1/8	2,52
8/6 mm	1/4"	1120 8/6 1/4	3,04
10/8 mm	1/4"	1120 10/8 1/4	3,42
10/8 mm	3/8"	1120 10/8 3/8	5,91

## Racordaje rápido

Raccords rapides  
Tapered quick couplings  
Raccordatura rapida

### Codo intermedio



Raccord coudé intermédiaire  
Elbow connector  
Raccordo a 90 intermedio

TUBO PIPE	REFERENCIA PART N°	€
4/2,7 mm	1130 4/2.7	3,71
6/4 mm	1130 6/4	2,75
8/6 mm - 6/4 mm	1130 8/6 6/4	2,98
8/6 mm	1130 8/6	3,04
10/8 mm	1130 10/8	3,86
12/10 mm	1130 12/10	5,21

### Cruz intermedia



Raccord en croix intermédiaire  
Equal cross connector  
Raccordo a croce intermedio

TUBO PIPE	REFERENCIA PART N°	€
6/4 mm	1300 6/4	5,80
8/6 mm	1300 8/6	6,66
10/8 mm	1300 10/8	8,35
12/10 mm	1300 12/10	11,92

### Te macho central giratorio cónico



Raccord en té avec tournant mâle central  
Orienting tee male adaptor tapered-centre leg  
Raccordo a Tmaschio conico girevole centrale

TUBO PIPE	ROSCA THREAD	REFERENCIA PART N°	€
6/4 mm	1/8"	1210 6/4 1/8	4,70
6/4 mm	1/4"	1210 6/4 1/4	4,87
8/6 mm	1/8"	1210 8/6 1/8	4,70
8/6 mm	1/4"	1210 8/6 1/4	5,13
10/8 mm	1/4"	1210 10/8 1/4	6,37

### Tornillo orientable simple y doble



Vis pour banjo simple et double  
Banjo stem single and double  
Bullone forato semplice e doppio

ROSCA THREAD	REFERENCIA PART N°	€
1/8"	51410 1/8	1,53
1/4"	51410 1/4	1,95
3/8"	51410 3/8	2,85
1/2"	51410 1/2	4,92
1/8"	51420 1/8	2,15
1/4"	51420 1/4	3,08
3/8"	51420 3/8	4,64
1/2"	51420 1/2	7,89

Hasta fin de existencias // Jusqu'à la fin du stock // Until end of stock // Fino ad esaurimento scorta

### Te lateral cónica macho



Raccord en té avec mâle conique latéral  
Tee male adaptor tapered-off-set-leg  
Raccordo a Y laterale conico maschio

TUBO PIPE	ROSCA THREAD	REFERENCIA PART N°	€
6/4 mm	1/8"	1220 6/4 1/8	2,96
6/4 mm	1/4"	1220 6/4 1/4	3,11
8/6 mm	1/8"	1220 8/6 1/8	3,33
8/6 mm	1/4"	1220 8/6 1/4	3,50
10/8 mm	1/4"	1220 10/8 1/4	4,43
10/8 mm	3/8"	1220 10/8 3/8	5,21
12/10 mm	3/8"	1220 12/10 3/8	6,40

### Orientable simple



Banjo simple  
Single banjo body  
Occhio orientabile semplice

TUBO PIPE	ROSCA THREAD	REFERENCIA PART N°	€
4/2,7 mm	1/8"	1500 4/2.7 1/8	2,41
6/4 mm	1/8"	1500 6/4 1/8	2,66
6/4 mm	1/4"	1500 6/4 1/4	2,72
6/4 mm	3/8"	1500 6/4 3/8	3,43
6/4 mm	M6	1500 6/4 M6	2,18
8/6 mm	1/8"	1500 8/6 1/8	2,72
8/6 mm	1/4"	1500 8/6 1/4	2,85
8/6 mm	3/8"	1500 8/6 3/8	3,65
8/6 mm	1/2"	1500 8/6 1/2	4,27
10/8 mm	1/8"	1500 10/8 1/8	2,87
10/8 mm	1/4"	1500 10/8 1/4	3,08
10/8 mm	3/8"	1500 10/8 3/8	3,89
10/8 mm	1/2"	1500 10/8 1/2	4,46
12/10 mm	3/8"	1500 12/10 3/8	4,59
12/10 mm	1/2"	1500 12/10 1/2	5,69

### Te intermedia



Raccord en té intermédiaire  
Tee connector  
Raccordo a T intermedio

TUBO PIPE	REFERENCIA PART N°	€
4/2,7 mm	1230 4/2.7	4,14
6/4 mm	1230 6/4	3,54
8/6 mm	1230 8/6	3,95
10/8 mm	1230 10/8	5,16
12/10 mm	1230 12/10	7,17

## Racordaje rápido

Raccords rapides  
Tapered quick couplings  
Raccordatura rapida

Pipe

### Orientable doble



Banjo double

Double banjo body

Occhio orientabile doppio

TUBO PIPE	ROSCA THREAD	REFERENCIA PART N°	€
4/2,7 mm	1/8"	1510 4/2.7 1/8	4,41
6/4 mm	1/8"	1510 6/4 1/8	4,21
6/4 mm	1/4"	1510 6/4 1/4	4,76
6/4 mm	3/8"	1510 6/4 3/8	5,54
8/6 mm	1/8"	1510 8/6 1/8	4,67
8/6 mm	1/4"	1510 8/6 1/4	4,67
8/6 mm	3/8"	1510 8/6 3/8	5,54
8/6 mm	1/2"	1510 8/6 1/2	6,37
10/8 mm	1/8"	1510 10/8 1/8	5,10
10/8 mm	1/4"	1510 10/8 1/4	5,16
10/8 mm	3/8"	1510 10/8 3/8	5,88
10/8 mm	1/2"	1510 10/8 1/2	7,04
12/10 mm	3/8"	1510 12/10 3/8	6,79
12/10 mm	1/2"	1510 12/10 1/2	7,53

Fittings

Quick release  
couplings

Industrial elements

### Recto cilíndrico macho con tórica



Raccord droit mâle cylindrique

Straight male adaptor parallel

Raccordo maschio cilindrico con o-ring

TUBO PIPE	ROSCA THREAD	REFERENCIA PART N°	€
4/2,7 mm	1/8"	1020 4/2.7 1/8	1,51
6/4 mm	1/8"	1020 6/4 1/8	1,51
6/4 mm	1/4"	1020 6/4 1/4	2,02
6/4 mm	3/8"	1020 6/4 3/8	2,55
6/4 mm	1/2"	1020 6/4 1/2	4,17
8/6 mm	1/8"	1020 8/6 1/8	1,73
8/6 mm	1/4"	1020 8/6 1/4	1,98
8/6 mm	3/8"	1020 8/6 3/8	2,52
8/6 mm	1/2"	1020 8/6 1/2	4,09
10/8 mm	1/4"	1020 10/8 1/4	2,37
10/8 mm	3/8"	1020 10/8 3/8	2,85
10/8 mm	1/2"	1020 10/8 1/2	4,49
12/10 mm	3/8"	1020 12/10 3/8	3,19
12/10 mm	1/2"	1020 12/10 1/2	4,88
6/4 mm	M5	1021 6/4 M5	1,40
6/4 mm	M6	1021 6/4 M6	1,40

Cylinders

### Giratorio cilind. macho con muelle



Raccord droit tournant mâle cylindrique avec ressort

Orienting straight male adaptor parallel + nut and spring

Raccordo maschio cilindrico girevole con molla

TUBO PIPE	ROSCA THREAD	REFERENCIA PART N°	€
6/4 mm	1/8"	1027 6/4 1/8	4,17
6/4 mm	1/4"	1027 6/4 1/4	4,52
8/6 mm	1/8"	1027 8/6 1/8	4,24
8/6 mm	1/4"	1027 8/6 1/4	4,64
10/8 mm	1/4"	1027 10/8 1/4	5,21
12/10 mm	3/8"	1027 12/10 3/8	6,78

### Recto cilíndrico macho con muelle



Raccord droit mâle cylindrique avec ressort

Straight male adaptor parallel + nut and spring

Raccordo maschio +molla

TUBO PIPE	ROSCA THREAD	REFERENCIA PART N°	€
6/4 mm	1/8"	1028 6/4 1/8	2,85
6/4 mm	1/4"	1028 6/4 1/4	3,25
6/4 mm	3/8"	1028 6/4 3/8	3,57
6/4 mm	1/2"	1028 6/4 1/2	4,73
8/6 mm	1/8"	1028 8/6 1/8	2,93
8/6 mm	1/4"	1028 8/6 1/4	3,25
8/6 mm	3/8"	1028 8/6 3/8	3,65
8/6 mm	1/2"	1028 8/6 1/2	4,64
10/8 mm	1/4"	1028 10/8 1/4	3,71
10/8 mm	3/8"	1028 10/8 3/8	4,03
10/8 mm	1/2"	1028 10/8 1/2	5,05
12/10 mm	3/8"	1028 12/10 3/8	5,16
12/10 mm	1/2"	1028 12/10 1/2	6,34



## Racordaje rápido

Raccords rapides  
Tapered quick couplings  
Raccordatura rapida

### Codo giratorio cilíndrico macho



Raccord coudé tournant mâle cylindrique  
Orienting elbow male adaptor parallel  
Raccordo a 90 maschio girevole

TUBO PIPE	ROSCA THREAD	REFERENCIA PART N°	€
4/2,7 mm	1/8"	1115 4/2.7 1/8	3,42
6/4 mm	1/8"	1115 6/4 1/8	3,42
6/4 mm	1/4"	1115 6/4 1/4	3,95
8/6 mm	1/8"	1115 8/6 1/8	3,65
8/6 mm	1/4"	1115 8/6 1/4	4,09
10/8 mm	1/4"	1115 10/8 1/4	4,70

### Te central giratoria cilíndrico macho



Raccord en té avec tournant mâle central  
Orienting tee male adaptor parallel-centre leg  
Raccordo a Tmaschio girevole centrale

TUBO PIPE	ROSCA THREAD	REFERENCIA PART N°	€
6/4 mm	1/8"	1215 6/4 1/8	4,92
6/4 mm	1/4"	1215 6/4 1/4	5,10
8/6 mm	1/8"	1215 8/6 1/8	4,92
8/6 mm	1/4"	1215 8/6 1/4	5,40
10/8 mm	1/4"	1215 10/8 1/4	6,69

## Accesorios

Accessoires  
Accessories  
Accessori

Pipe

### Machón cónico



Adapteur mâle-mâle conique  
Nipple tapered  
Maschio conico

ROSCA THREAD	REFERENCIA PART N°	€
1/8"	2000 1/8	0,70
1/4"	2000 1/4	1,05
3/8"	2000 3/8	1,44
1/2"	2000 1/2	2,41
3/4"	2000 3/4	5,19
1"	2000 1	6,44

### Tapón reductor cónico



Bouchon réducteur conique  
Reducer tapered  
Tappo di riduzione conico

ROSCA THREAD	REFERENCIA PART N°	€
1/4"-1/8"	2080 1/4 1/8	0,71
3/8"-1/8"	2080 3/8 1/8	1,19
3/4"-3/8"	2080 3/8 1/4	1,11
1/2"-1/8"	2080 1/2 1/8	1,91
1/2"-1/4"	2080 1/2 1/4	2,82
1/2"-3/8"	2080 1/2 3/8	1,70
3/4"-3/8"	2080 3/4 3/8	4,68
3/4"-1/2"	2080 3/4 1/2	3,61

### Machón cónico de reducción



Réducteur mâle-mâle conique  
Reducing nipple tapered  
Maschio conico di riduzione

ROSCA THREAD	REFERENCIA PART N°	€
1/8"-1/4"	2020 1/8-1/4	1,31
1/8"-3/8"	2020 1/8 3/8	1,37
1/8"-1/2"	2020 1/8 1/2	2,76
1/4"-1/2"	2020 1/4 1/2	2,91
1/4"-3/8"	2020 1/4-3/8	1,39
3/8"-1/2"	2020 3/8-1/2	2,89
1/2"-3/4"	2020 1/2 3/4	4,25

### Machón cilíndrico



Adapteur mâle-mâle cylindrique  
Nipple parallel  
cilindrico

ROSCA THREAD	REFERENCIA PART N°	€
1/8"	2010 1/8	0,78
1/4"	2010 1/4	1,28
3/8"	2010 3/8	1,71
1/2"	2010 1/2	3,15
3/4"	2010 3/4	4,25
1"	2010 1	6,38

### Prolongación cónica



Prolongateur conique  
Reducer tapered  
Prolunga conica

ROSCA THREAD	REFERENCIA PART N°	€
1/8"-1/8"	2040 1/8 1/8	0,90
1/8"-1/4"	2040 1/8 1/4	1,49
1/8"-3/8"	2040 1/8 3/8	2,13
1/4"-1/4"	2040 1/4 1/4	1,84
1/4"-3/8"	2040 1/4 3/8	2,12
1/4"-1/2"	2040 1/4 1/2	2,98
3/8"-3/8"	2040 3/8 3/8	2,62
3/8"-1/2"	2040 3/8 1/2	3,22
1/2"-1/2"	2040 1/2 1/2	3,83
1/2"-3/4"	2040 1/2 3/4	5,69

### Machón cilíndrico de reducción



Réducteur mâle-mâle cylindrique  
Reducing nipple parallel  
Maschio cilindrico di riduzione

ROSCA THREAD	REFERENCIA PART N°	€
M5-1/8"	2030 M5 1/8	0,92
1/8"-1/4"	2030 1/8 1/4	1,42
1/8"-3/8"	2030 1/8 3/8	1,63
1/4"-3/8"	2030 1/4 3/8	1,77
1/4"-1/2"	2030 1/4 1/2	2,69
3/8"-1/2"	2030 3/8 1/2	3,12
1/2"-3/4"	2030 1/2 3/4	4,53

Fittings

Quick release  
couplings

Industrial elements

Cylinders

## Accesorios

Accessoires  
Accessories  
Accessori

### Prolongación cilíndrica



Prolongateur cylindrique  
Reducer parallel  
Prolunga cilindrica

ROSCA THREAD	REFERENCIA PART N°	€
M5-1/8"	2050 M5 1/8	0,90
1/8"-1/8"	2050 1/8 1/8	0,85
1/8"-1/4"	2050 1/8 1/4	1,49
1/4"-1/4"	2050 1/4 1/4	1,33
1/4"-3/8"	2050 1/4 3/8	1,91
3/8"-3/8"	2050 3/8 3/8	2,21
3/8"-1/2"	2050 3/8 1/2	3,88
1/2"-1/2"	2050 1/2 1/2	4,89

### Manguito hembra



Manchon femelle  
Sleeve  
Prolunga femmina

ROSCA THREAD	REFERENCIA PART N°	€
1/8"	3000 1/8	0,78
1/4"	3000 1/4	1,49
3/8"	3000 3/8	2,69
1/2"	3000 1/2	4,46
3/4"	3000 3/4	6,66

### Prolongación cilíndrica



Prolongateur cylindrique  
Extension parallel  
Prolunga cilindrica

ROSCA THREAD	REFERENCIA PART N°	€
1/8"-1/8"	2070 1/8 1/8 22	1,16
1/8"-1/8"	2070 1/8 1/8 42	2,21
1/4"-1/4"	2070 1/4 1/4 35	2,09
1/4"-1/4"	2070 1/4 1/4 51	3,10

### Manguito hembra de reducción



Manchon femelle de réduction  
Reducing sleeve  
Prolunga femmina di riduzione

ROSCA THREAD	REFERENCIA PART N°	€
1/8"-1/4"	3010 1/8 1/4	1,63
1/8"-3/8"	3010 1/8 3/8	1,70
1/4"-3/8"	3010 1/4 3/8	2,34
1/4"-1/2"	3010 1/4 1/2	1,70
3/8"-1/2"	3010 3/8 1/2	3,40
1/2"-3/4"	3010 1/2 3/4	5,46

### Pasatabique



Passe-cloison  
Bulkhead connector  
Passaparete

ROSCA THREAD	REFERENCIA PART N°	€
1/8"	3060 1/8	2,83
1/4"	3060 1/4	3,90
3/8"	3060 3/8	6,73
1/2"	3060 1/2	8,22
M5	3060 M5	1,20

### Tapón reductor cilíndrico



Bouchon réducteur cylindrique  
Reducer parallel  
Tappo di riduzione cilindrico

ROSCA THREAD	REFERENCIA PART N°	€
1/8"-M5	2090 1/8 M5	0,79
1/4"-1/8"	2090 1/4 1/8	0,85
3/8"-1/8"	2090 3/8 1/8	1,31
3/8"-1/4"	2090 3/8 1/4	0,99
1/2"-1/4"	2090 1/2 1/4	2,62
1/2"-3/8"	2090 1/2 3/8	1,64
3/4"-1/2"	2090 3/4 1/2	3,15

### Orientable hembra



Banjo femelle  
Female single banjo body  
Occhio filettato femmina

ROSCA THREAD	REFERENCIA PART N°	€
1/8"	6090 1/8	2,14
1/4"	6090 1/4	2,72
3/8"	6090 3/8	3,76

## Accesorios

Accessoires  
Accessories  
Accessori

Pipe

Fittings

Quick release  
couplings

Industrial elements

Cylinders

### Tapón macho cilíndrico Allen



Bouchon mâle cylindrique allen  
Male plug parallel with hexagon embedded  
Tappo maschio cilindrico Allen

ROSCA THREAD	REFERENCIA PART N°	€
1/8"	3015 1/8	0,78
1/4"	3015 1/4	1,36
3/8"	3015 3/8	1,77
1/2"	3015 1/2	3,26

### Tapón macho cónico Allen interior



Bouchon mâle conique allen intérieur  
Male plug tapered  
Tappo maschio conico Allen

ROSCA THREAD	REFERENCIA PART N°	€
1/8"	3025 1/8	0,50
1/4"	3025 1/4	0,71
3/8"	3025 3/8	0,96
1/2"	3025 1/2	1,91

### Tapón macho cilíndrico



Bouchon mâle cylindrique  
Male plug parallel  
Tappo maschio cilindrico

ROSCA THREAD	REFERENCIA PART N°	€
1/8"	3020 1/8	0,70
1/4"	3020 1/4	0,96
3/8"	3020 3/8	1,27
1/2"	3020 1/2	2,14
3/4"	3020 3/4	3,48

### Tapón hembra



Bouchon femelle  
Female plug  
Tappo femmina

ROSCA THREAD	REFERENCIA PART N°	€
1/8"	3030 1/8	0,66
1/4"	3030 1/4	1,13
3/8"	3030 3/8	1,66
1/2"	3030 1/2	2,63

### Espiga macho cónico



Douille mâle conique  
Male hose adapter tapered  
Inserto maschio conico

TUBO PIPE	ROSCA THREAD	REFERENCIA PART N°	€
6 mm	1/8"	3040 6 1/8	0,78
6 mm	1/4"	3040 6 1/4	1,20
7 mm	1/8"	3040 7 1/8	1,35
7 mm	1/4"	3040 7 1/4	1,20
8 mm	1/8"	3040 8 1/8	0,85
8 mm	1/4"	3040 8 1/4	1,70
9 mm	1/8"	3040 9 1/8	1,45
9 mm	1/4"	3040 9 1/4	1,28
9 mm	3/8"	3040 9 3/8	1,77
9 mm	1/2"	3040 9 1/2	3,15
10 mm	1/4"	3040 10 1/4	1,58
10 mm	3/8"	3040 10 3/8	1,77
10 mm	1/2"	3040 10 1/2	2,76
12 mm	1/4"	3040 12 1/4	1,31
12 mm	3/8"	3040 12 3/8	1,77
12 mm	1/2"	3040 12 1/2	2,76
14 mm	3/8"	3040 14 3/8	1,84
14 mm	1/2"	3040 14 1/2	2,91
16 mm	3/8"	3040 16 3/8	2,02
16 mm	1/2"	3040 16 1/2	3,19

### Espiga hembra



Douille femelle  
Female hose adapter  
Inserto femmina

TUBO PIPE	ROSCA THREAD	REFERENCIA PART N°	€
6 mm	1/8"	3050 6 1/8	0,99
7 mm	1/8"	3050 7 1/8	0,99
7 mm	1/4"	3050 7 1/4	1,63
8 mm	1/4"	3050 8 1/4	1,49
9 mm	1/4"	3050 9 1/4	1,63
9 mm	3/8"	3050 9 3/8	2,05
10 mm	3/8"	3050 10 3/8	2,05
12 mm	3/8"	3050 12 3/8	2,20
12 mm	1/2"	3050 12 1/2	3,33

### Espiga doble



Douille double jonction  
Double hose adapter  
Inserto doppio

TUBO PIPE	REFERENCIA PART N°	€
6 mm	3055 6	0,43
8 mm	3055 8	0,57
10 mm	3055 10	0,71

## Accesorios

Accessoires  
Accessories  
Accessori

335

### Espiga macho cilíndrico



Douille mâle cylindrique  
Male hose adapter parallel  
Inserto maschio cilindrico

TUBO PIPE	ROSCA THREAD	REFERENCIA PART N°	€
7 mm	1/8"	3045 7 1/8	0,92
7 mm	1/4"	3045 7 1/4	1,35
8 mm	1/8"	3045 8 1/8	0,92
9 mm	1/8"	3045 9 1/8	1,13
9 mm	1/4"	3045 9 1/4	1,49
9 mm	3/8"	3045 9 3/8	2,05
12 mm	1/4"	3045 12 1/4	1,84
12 mm	3/8"	3045 12 3/8	2,20
12 mm	1/2"	3045 12 1/2	3,54

### Codo macho



Raccord coudé mâle-mâle  
Male elbow  
Adattore a 90 maschio conico

ROSCA THREAD	REFERENCIA PART N°	€
1/8"	5000 1/8	1,20
1/4"	5000 1/4	1,98
3/8"	5000 3/8	2,48
1/2"	5000 1/2	4,39
3/4"	5000 3/4	7,23

### Codo macho-hembra



Raccord coudé mâle-femelle  
Male-female elbow  
Adattore maschio conico-femmina

ROSCA THREAD	REFERENCIA PART N°	€
1/8"	5020 1/8	1,56
1/4"	5020 1/4	2,34
3/8"	5020 3/8	3,75
3/4"	5020 3/4	8,78
1/2"	5020 1/2	5,11

### Codo hembra



Raccord coudé femelle-femelle  
Female elbow  
Adattore a 90 femmina

ROSCA THREAD	REFERENCIA PART N°	€
1/8"	5010 1/8	1,84
1/4"	5010 1/4	2,55
3/8"	5010 3/8	3,83
1/2"	5010 1/2	6,64
3/4"	5010 3/4	10,06

## Accesorios

Accessoires  
Accessories  
Accessori

Pipe

Fittings

### Te hembra



Raccord en té femelle  
Female tee  
Adattatore a T femmina

ROSCA THREAD	REFERENCIA PART N°	€
1/8"	4000 1/8	1,98
1/4"	4000 1/4	4,25
3/8"	4000 3/8	4,85
1/2"	4000 1/2	7,95
3/4"	4000 3/4	13,81

### Te macho central



Raccord en té mâle central  
Centre leg male tee  
Adattatore a T maschio conico centrale

ROSCA THREAD	REFERENCIA PART N°	€
1/8"	4040 1/8	2,05
1/4"	4040 1/4	4,68
3/8"	4040 3/8	5,38
1/2"	4040 1/2	10,41
3/4"	4040 3/4	12,40

### Te macho



Raccord en té mâle  
Male tee  
Adattatore a T maschio conico

ROSCA THREAD	REFERENCIA PART N°	€
1/8"	4010 1/8	2,37
1/4"	4010 1/4	3,37
3/8"	4010 3/8	4,64
1/2"	4010 1/2	7,95
3/4"	4010 3/4	10,88

### Te lateral macho



Raccord en té mâle latéral  
Off-set male tee  
Adattatore a T maschio conico laterale

ROSCA THREAD	REFERENCIA PART N°	€
1/8"	4050 1/8	1,77
1/4"	4050 1/4	4,25
3/8"	4050 3/8	7,01
1/2"	4050 1/2	9,07
3/4"	4050 3/4	12,54

### Cruz hembra



Raccord en croix femelle  
Female equal cross  
Croce femmina

ROSCA THREAD	REFERENCIA PART N°	€
1/8"	6020 1/8	4,25
1/4"	6020 1/4	5,31
3/8"	6020 3/8	7,79
1/2"	6020 1/2	13,32

### Derivación en Y 90° macho



Raccord en Y mâle  
90° Male Y  
Adattatore a Y maschio

ROSCA THREAD	REFERENCIA PART N°	€
1/8"	6000 1/8	2,13
1/4"	6000 1/4	2,69
3/8"	6000 3/8	3,75
1/2"	6000 1/2	9,19

### Cruz macho



Raccord en croix mâle  
Male equal cross  
Croce maschio

ROSCA THREAD	REFERENCIA PART N°	€
1/8"	6030 1/8	1,70
1/4"	6030 1/4	3,19
3/8"	6030 3/8	5,10
1/2"	6030 1/2	7,01

Quick release  
couplings

Industrial elements

Cylinders

## Accesorios

Accessoires  
Accessories  
Accessori

337

Pipe

Fittings

Quick release  
couplings

Industrial elements

Cylinders

### Cruz en taco aluminio



Nourrices de distribution en croix taraudée

Aluminium cross

Croce in blocco

ROSCA THREAD	REFERENCIA PART N°	€
1/8"	6040 1/8	4,24
1/4"	6040 1/4	6,59
3/8"	6040 3/8	10,24
1/2"	6040 1/2	12,38

### Regleta en taco lateral simple



Nourrices de distribution taraudée

Aluminium distribution manifold

Blocco a multiscite

ROSCA THREAD	N° DE SALIDAS N. EXITS	REFERENCIA PART N°	€
(1) 1/8" - (2) 1/4"	2	6047 1/4 1/8 2	12,00
(1) 1/8" - (2) 1/4"	3	6047 1/4 1/8 3	16,33
(1) 1/8" - (2) 1/4"	4	6047 1/4 1/8 4	21,20
(1) 1/8" - (2) 1/4"	5	6047 1/4 1/8 5	27,14
(1) 1/8" - (2) 1/4"	6	6047 1/4 1/8 6	31,81
(1) 1/4" - (2) 3/8"	2	6047 3/8 1/4 2	14,27
(1) 1/4" - (2) 3/8"	3	6047 3/8 1/4 3	17,13
(1) 1/4" - (2) 3/8"	4	6047 3/8 1/4 4	22,62
(1) 1/4" - (2) 3/8"	5	6047 3/8 1/4 5	28,13
(1) 1/4" - (2) 3/8"	6	6047 3/8 1/4 6	33,87
(1) 3/8" - (2) 1/2"	2	6047 1/2 3/8 2	17,69
(1) 3/8" - (2) 1/2"	3	6047 1/2 3/8 3	21,17
(1) 3/8" - (2) 1/2"	4	6047 1/2 3/8 4	26,59
(1) 3/8" - (2) 1/2"	5	6047 1/2 3/8 5	31,14
(1) 3/8" - (2) 1/2"	6	6047 1/2 3/8 6	36,44

# Enchufes rápidos neumáticos

Coupleurs pneumatiques

Quick release couplings

Innesti rapidi



# 3

Enchufes rápidos Esto	340
Coupleurs rapides type Esto   Quick release couplings "Esto"   Innesti rapidi tipo ESTO	
Enchufes rápidos mini industriales	341
Coupleurs rapides mini-industriels   Automatic quick release couplings industrial   Innesti rapido mini industriali	

## Enchufes rápidos Esto

Coupleurs rapides type Esto | Quick release couplings "Esto" | Innessi rapidi tipo ESTO

Pipe

### ▶ Enchufes 1/4 | Coupleurs 1/4 | Quick couplings 1/4 | Innessi 1/4

343



ESTO 1

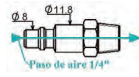

ESTO 1

Fittings

### ▶ Enchufes 3/8 | Coupleurs 3/8 | Quick couplings 3/8 | Innessi 3/8

343



ESTO 3

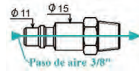

ESTO 3

Quick release couplings

### ▶ Enchufes 1/2 | Coupleurs 1/2 | Quick couplings 1/2 | Innessi 1/2

343



ESTO 2

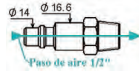

ESTO 2

Industrial elements

Cylinders

# ▶ Enchufes rápidos mini industriales

Coupleurs rapides mini-industriels | Automatic quick release couplings industrial | Innesti rapido mini industriali

## ▶ Enchufes mini - serie mignon | Coupleurs mini - série mignon | Mini serie mignon | Innesti mini- serie mignon

344



## ▶ Enchufes mini - serie uni ISO 6150 B-12 | Coupleurs mini - série uni ISO 6150 B-12 | Mini-serie uni ISO 6150 B-12 | Innesti mini -serie uni ISO 6150 B-12

345



## ▶ Enchufes mini - serie multipresa | Coupleurs mini - série multiprise | Mini-serie multipress | Innesti mini -serie multipress

346



Pipe

Fittings

Quick release couplings

Industrial elements

Cylinders



## Enchufes rápidos Esto

Coupleurs rapides type Esto  
Quick release couplings "Esto"  
Innesti rapidi tipo ESTO

### Enchufe hembra 1/4



Coupleur femelle 1/4

Female quick couplings 1/4

Innesto hembra 1/4

ROSCA THREAD	Ø ESPIGA Ø NIPPLE	REFERENCIA PART N°	€
M 1/4" BSPT	-	<b>ESTO 110</b>	<b>19,95</b>
M 3/8" BSPT	-	<b>ESTO 140</b>	<b>20,24</b>
M 1/2" BSPT	-	<b>ESTO 142</b>	<b>20,60</b>
H 1/4" BSP	-	<b>ESTO 120</b>	<b>19,95</b>
H 3/8" BSP	-	<b>ESTO 150</b>	<b>20,45</b>
-	8 mm	<b>ESTO 130</b>	<b>20,24</b>
-	10 mm	<b>ESTO 131</b>	<b>20,24</b>

### Boquilla macho 1/4

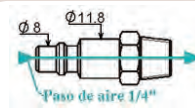

Coupleur embout mâle 1/4

Male 1/4 fitting

Innesto maschio 1/4

ROSCA THREAD	Ø ESPIGA Ø NIPPLE	REFERENCIA PART N°	€
M 1/4" BSPT	-	<b>ESTO 160</b>	<b>4,71</b>
M 3/8" BSPT	-	<b>ESTO 163</b>	<b>5,85</b>
M 1/2" BSPT	-	<b>ESTO 162</b>	<b>8,92</b>
H 1/4" BSP	-	<b>ESTO 170</b>	<b>4,71</b>
H 3/8" BSP	-	<b>ESTO 173</b>	<b>5,85</b>
-	6 mm	<b>ESTO 181</b>	<b>4,71</b>
-	8 mm	<b>ESTO 180</b>	<b>4,71</b>
-	10 mm	<b>ESTO 182</b>	<b>4,71</b>

### Enchufes hembra 3/8



Coupleur femelle 3/8

Female quick coupling 3/8

Innesto femmina 3/8

ROSCA THREAD	Ø ESPIGA Ø NIPPLE	REFERENCIA PART N°	€
M 3/8" BSPT	-	<b>ESTO 310</b>	<b>34,05</b>
H 3/8" BSP	-	<b>ESTO 320</b>	<b>34,05</b>
-	12 mm	<b>ESTO 330</b>	<b>35,73</b>

### Boquillas macho 3/8

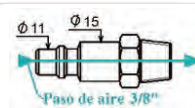

Coupleur embout mâle 3/8

Male 3/8 fitting

Innesto maschio 3/8

ROSCA THREAD	Ø ESPIGA Ø NIPPLE	REFERENCIA PART N°	€
M 3/8" BSPT	-	<b>ESTO 360</b>	<b>7,39</b>
H 3/8" BSP	-	<b>ESTO 370</b>	<b>7,39</b>
-	12 mm	<b>ESTO 380</b>	<b>8,10</b>

### Enchufes hembra 1/2



Coupleur femelle 1/2

Female quick coupling 1/2

Innesto femmina 1/2

ROSCA THREAD	Ø ESPIGA Ø NIPPLE	REFERENCIA PART N°	€
M 1/2" BSPT	-	<b>ESTO 210</b>	<b>47,22</b>
H 1/2" BSP	-	<b>ESTO 220</b>	<b>47,22</b>

### Boquillas macho 1/2

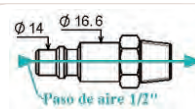

Coupleur embout mâle 1/2

Male 1/2 fitting

Innesto maschio 1/2

ROSCA THREAD	Ø ESPIGA Ø NIPPLE	REFERENCIA PART N°	€
M 1/2" BSPT	-	<b>ESTO 260</b>	<b>9,35</b>
H 1/2" BSP	-	<b>ESTO 270</b>	<b>9,99</b>

## Enchufes rápidos mini industriales

Coupleurs rapides mini-industriels  
Automatic quick release couplings industrial  
Innesti rapido mini industriali

Pipe

Fittings

Quick release couplings

Industrial elements

Cylinders

### Enchufe hembra a rosca macho-serie mignon



Coupleur femelle à mâle- série mignon

Male socket-serie mignon

Innesto femmina a filetto mascho-serie mignon

ROSCA THREAD	REFERENCIA PART N°	€
M 1/8" BSP	111 1/8	3,61
M 1/4" BSP	111 1/4	5,70
M 3/8" BSP	111 3/8	3,19

### Enchufe macho a rosca macho-serie mignon



Coupleur mâle à mâle- série mignon

Male plug-serie mignon

Innesto mascho a filetto mascho-serie mignon

ROSCA THREAD	REFERENCIA PART N°	€
M 1/8" BSP	211 1/8	1,17
M 1/4" BSP	211 1/4	1,47
M 3/8" BSP	211 3/8	1,51

### Enchufe hembra a rosca hembra-serie mignon



Coupleur femelle à femelle- série mignon

Female socket-serie mignon

Innesto femmina a filetto femmina-serie mignon

ROSCA THREAD	REFERENCIA PART N°	€
H 1/8" BSP	112 1/8	3,68
H 1/4" BSP	112 1/4	3,68
H 3/8" BSP	112 3/8	3,68

### Enchufe macho a rosca hembra-serie mignon



Coupleur mâle à femelle- série mignon

Female plug-serie mignon

Innesto mascho a filetto femmina-serie mignon

ROSCA THREAD	REFERENCIA PART N°	€
H 1/8" BSP	212 1/8	1,07
H 1/4" BSP	212 1/4	1,44
H 3/8" BSP	212 3/8	1,47

### Enchufe hembra a tubo muelle-serie mignon



Coupleur femelle à tube ressort- série mignon

Compression socket with spring-serie mignon

Innesto femmina a tubo molla-serie mignon

TUBO PIPE	REFERENCIA PART N°	€
6/4 mm	113 6/4	9,75
8/6 mm	113 8/6	9,75

### Enchufe macho a tubo muelle-serie mignon



Coupleur mâle à tube ressort- série mignon

Compression plug with spring-serie mignon

Innesto mascho a tubo molla-serie mignon

TUBO PIPE	REFERENCIA PART N°	€
6/4 mm	213 6/4	3,36
8/6 mm	213 8/6	3,53

### Enchufe hembra a tubo-serie mignon



Coupleur femelle à tube- série mignon

Compression socket-serie mignon

Innesto femmina a tubo-serie mignon

TUBO PIPE	REFERENCIA PART N°	€
6/4 mm	114 6/4	8,35
8/6 mm	114 8/6	8,35

### Enchufe macho a tubo-serie mignon



Coupleur mâle à tube- série mignon

Compression plug-serie mignon

Innesto mascho a tubo-serie mignon

TUBO PIPE	REFERENCIA PART N°	€
6/4 mm	214 6/4	2,18
8/6 mm	214 8/6	2,29

### Enchufe hembra a espiga-serie mignon



Coupleur femelle à douille- série mignon

Socket with rest for rubber hose-serie mignon

Innesto femmina ad inserto-serie mignon

Ø ESPIGA Ø NIPPLE	REFERENCIA PART N°	€
4 mm	115 4	7,88
6mm	115 6	7,88
8 mm	115 8	7,88

### Enchufe macho a espiga-serie mignon



Coupleur mâle à douille- série mignon

Plug with rest for rubber hose-serie mignon

Innesto mascho ad inserto-serie mignon

Ø ESPIGA Ø NIPPLE	REFERENCIA PART N°	€
6 mm	215 6	1,44
4 mm	215 4	1,44
8 mm	215 8	1,69

## Enchufes rápidos mini industriales

Coupleurs rapides mini-industriels  
Automatic quick release couplings industrial  
Innesti rapido mini industriali

### Enchufe hembra a rosca macho - serie uni ISO 6150 B-12



Coupleur femelle à mâle- série uni ISO 6150 B-12

Male socket-serie uni ISO 6150 B-12

Innesto femmina a filetto maschio-serie uni ISO 6150 B-12

ROSCA THREAD	REFERENCIA PART N°	€
M 1/4" BSP	121 1/4	7,36
M 3/8" BSP	121 3/8	7,36
M 1/2" BSP	121 1/2	8,83

### Enchufe macho a rosca macho - serie uni ISO 6150 B-12



Coupleur mâle à mâle- série uni ISO 6150 B-12

Male plug-serie uni ISO 6150 B-12

Innesto maschio a filetto maschio-serie uni ISO 6150 B-12

ROSCA THREAD	REFERENCIA PART N°	€
M 1/4" BSP	221 1/4	1,78
M 3/8" BSP	221 3/8	2,21
M 1/2" BSP	221 1/2	2,94

### Enchufe hembra a rosca hembra - serie uni ISO 6150 B-12



Coupleur femelle à femelle- série uni ISO 6150 B-12

Female socket-serie uni ISO 6150 B-12

Innesto femmina a filetto femmina-serie uni ISO 6150 B-12

ROSCA THREAD	REFERENCIA PART N°	€
H 1/4" BSP	122 1/4	7,91
H 3/8" BSP	122 3/8	7,97
H 1/2" BSP	122 1/2	8,77

### Enchufe macho a tubo muelle - serie uni ISO 6150 B-12



Coupleur mâle à tube ressort- série uni ISO 6150 B-12

Compression plug with spring-serie uni ISO 6150 B-12

Innesto maschio a tubo molla-serie uni ISO 6150 B-12

TUBO PIPE	REFERENCIA PART N°	€
6/4 mm	223 6/4	3,74
8/6 mm	223 8/6	3,97
10/8 mm	223 10/8	4,38
12/10 mm	223 12/10	4,92

### Enchufe hembra a espiga - serie uni ISO 6150 B-12



Coupleur femelle à douille- série uni ISO 6150 B-12

Socket with rest for rubber hose-serie uni ISO 6150 B-12

Innesto femmina ad inserto-serie uni ISO 6150 B-12

Ø ESPIGA Ø NIPPLE	REFERENCIA PART N°	€
6 mm	125 6	7,23
8 mm	125 8	7,54
10 mm	125 10	7,54
12 mm	125 12	7,54

### Enchufe macho a espiga - serie uni ISO 6150 B-12



Coupleur mâle à douille- série uni ISO 6150 B-12

Plug with rest for rubber hose-serie uni ISO 6150 B-12

Innesto maschio ad inserto-serie uni ISO 6150 B-12

Ø ESPIGA Ø NIPPLE	REFERENCIA PART N°	€
6 mm	225 6	1,10
8 mm	225 8	1,17
10 mm	225 10	1,23
12 mm	225 12	1,78

## Enchufes rápidos mini industriales

Coupleurs rapides mini-industriels  
Automatic quick release couplings industrial  
Innesti rapido mini industriali

Pipe

Fittings

Quick release couplings

Industrial elements

Cylinders

### Enchufe hembra a rosca macho- serie multipresa



Coupleur femelle à mâle- série multiprise

Male socket-multipress serie

Innesto femmina a filetto maschio-serie multipress

ROSCA THREAD	REFERENCIA PART N°	€
M 1/4" BSP	191 1/4	10,18
M 3/8" BSP	191 3/8	10,18
M 1/2" BSP	191 1/2	10,96

### Enchufe hembra a tubo-serie multipresa



Coupleur femelle à tube- série multiprise

Compression socket with spring-multipress serie

Innesto femmina a tubo-serie multipress

TUBO PIPE	REFERENCIA PART N°	€
6/4 mm	194 6/4	11,04
8/6 mm	194 8/6	11,28
10/8 mm	194 10/8	11,28

### Enchufe hembra a espiga-serie multipresa



Coupleur femelle à douille- série multiprise

Compression socket-multipress serie

Innesto femmina ad inserto-serie multipress

Ø ESPIGA Ø NIPPLE	REFERENCIA PART N°	€
6 mm	195 6	10,85
8 mm	195 8	10,85
10 mm	195 10	10,85
12 mm	195 12	10,85

### Enchufe hembra a rosca hembra- serie multipresa



Coupleur femelle à femelle- série multiprise

Female socket-multipress serie

Innesto femmina a filetto femmina-serie multipress

ROSCA THREAD	REFERENCIA PART N°	€
H 1/4" BSP	192 1/4	10,85
H 3/8" BSP	192 3/8	10,85
H 1/2" BSP	192 1/2	11,66

### Enchufe hembra con muelle- serie multipresa



Coupleur femelle avec ressort- série multiprise

Compression socket-multipress serie

Innesto femmina con molla-serie multipress

TUBO PIPE	REFERENCIA PART N°	€
6/4 mm	193 6/4	12,44
8/6 mm	193 8/6	12,84
10/8 mm	193 10/8	12,84



Gama de productos. Para más información soliciten nuestros catálogos generales o visiten nuestra página web  
Gamme de produits. Pour plus d'information, nous vous prions de nous demander nos catalogues généraux ou visiter notre web-site  
Products range. For any further information, please, ask for our general catalogues or visit our web-site  
Gamma di Prodotti. Per ulteriori informazioni di ricidete il nostri cataloghi o visitate la Nostra pagina web

2011



Racores en Acero Inoxidable  
Stainless Steel Fittings  
Raccords en Acier Inoxydable  
*Raccordi in Acciaio Inossidabile*

**AISI 316L**

# DICSA

[www.dicsaes.com](http://www.dicsaes.com)

# Elementos industriales - instalación

Éléments industriels - montage

Industrial elements

Elementi industriali

# 4

Accesorios neumáticos	350
Accessoires pneumatiques   Pneumatic accessories   Accessori pneumatici	
Válvulas neumáticas	352
Vannes pneumatiques   Pneumatic valves   Valvole pneumatiche	

## Accesorios neumáticos

Accessoires pneumatiques | Pneumatic accessories | Accessori pneumatici

Pipe

Fittings

Quick release couplings

Industrial elements

Cylinders

### ▶ Grupo filtración | Groupe de filtration | Frl groups | Gruppo di filtrazione

355



FIL



FR



FR+L



FRL



LUB



REG



MP



SF

### ▶ Grupo filtración mini | Groupe de filtration mini | Micro series | Gruppo di filtrazione mini

356



XF



XFR



XFRUL



XFRL



XL



XR



XSG



XRG

### ▶ Válvula de bola | Robinets | Ball valve | Valvola a sfera

358



6300



6310



6065

### ▶ Reguladores de flujo | Régulateurs de débit | Flow regulator | Regolatori di flusso

358



8850



8953



8860



8965

### ▶ Válvulas de seguridad | Vannes de sécurité | Relief valves | Valvole di sicurezza

359



VSN



VS

### ▶ Antiretorno | Antiretours | Non- return valves | Valvole antiritorno

359



6062



6034

▶ **Válvula de escape** | Vannes d'échappement | Exhaust valves | Valvole di scarico

360



6050



6060

▶ **Grifo purga** | Robinet de purge | Drain cock | Rubinetto di sfiato

360



16A

▶ **Silenciadores** | Silencieux | Silencer | Silenziatori

360



SE



SCQ



SFE



SVE

▶ **Accesorios** | Accessoires | Accessories | Accessori

361



--



ESTO 6

Pipe

Fittings

Quick release couplings

Industrial elements

Cylinders

# Válvulas neumáticas

Vannes pneumatiques | Pneumatic valves | Valvole pneumatiche

Pipe

Fittings

Quick release couplings

Industrial elements

Cylinders

362

▶ **Válvulas neumáticas** | Vannes pneumatiques | Pneumatic valves | Valvole pneumatiche

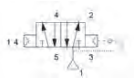

NEU100

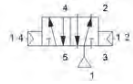

NEU100

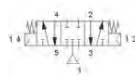

NEU100

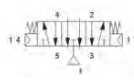

NEU100



NEU100

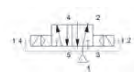

NEU100



NEU100

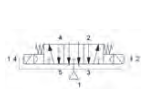

NEU100

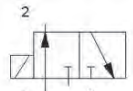

NEU100

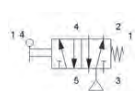

NEU100

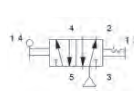

NEU100



NEU100



NEU100

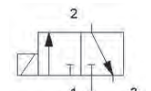

NEU100

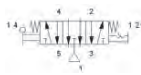

NEU100

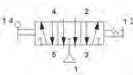

NEU100



NEU100



NEU100

▶ **Válvulas pulsador** | Vannes à poussoir | Push button | Valvole a pulsante

364



NEU100



NEU100



NEU100

▶ **Válvulas a leva** | Vannes à léva | Lever 3/2 ways | Valvole a leva

365



NEU1002

▶ **Válvulas selectoras palanca giratoria** | Vannes sélectrices à levier tournant | Lever 2/2 - 3/2 - 5/2 - 5/3 | Valvole selettice a leva girevole

365



NEU100

▶ **Válvulas de rodillo** | Vannes à rouleau | Roller lever | Valvole a rotella

365



NEU100



NEU100

▶ **Válvulas tetón** | Vanne fin de course | Pin valve | Valvole di fine corsa

366



NEU100

▶ **Microválvulas** | Micro-valves | Micro valves | Microvalvole

366



NEU100



NEU100



NEU100



NEU100



NEU100

▶ **Pedales** | Pédales | Foot pedal | Pedali

367



PC/PS



PML

▶ **Nebulizador** | Nébulisateur | Nebulizer | Nebulizzatore

367



NEU1005

▶ **Válvulas corte aire aceite baja presión** | Vanne à clapet basse pression | Air/Oil valves low pressure | Valvole aria-olio n.a. bassa pressione

368



VCBP...NA



VCBP...NC



C

▶ **Válvula cabina** | Valve de cabine | Cabin valve | Valvole cabina

368



A6103

Pipe

Fittings

Quick release couplings

Industrial elements

Cylinders





## Accesorios neumáticos

Accessoires pneumatiques  
Pneumatic accessories  
Accessori pneumatici

355

### Filtro Metálico



Filtre  
Filter  
Filtro metallico

ROSCA THREAD	REFERENCIA PART N°	€
1/4" BSP	<b>FIL 1/4 M</b>	<b>16,77</b>
1/2" BSP	<b>FIL 1/2 M</b>	<b>35,36</b>
1" BSP	<b>FIL 1 M</b>	<b>52,63</b>

### Lubricador Metálico



Lubrificateur  
Atomised lubricant  
Lubrificatore metallico

ROSCA THREAD	REFERENCIA PART N°	€
1/4" BSP	<b>LUB 1/4 M</b>	<b>16,77</b>
1/2" BSP	<b>LUB 1/2 M</b>	<b>35,36</b>
1" BSP	<b>LUB 1 M</b>	<b>55,73</b>

### Filtro-regulador estandar Metálico



Filtre-régulateur standard  
Filter-pressure reducer  
Filtro-regolatore si pressione standard

ROSCA THREAD	REFERENCIA PART N°	€
1/4" BSP	<b>FR 1/4 M</b>	<b>40,34</b>
1/2" BSP	<b>FR 1/2 M</b>	<b>81,63</b>
1" BSP	<b>FR 1 M</b>	<b>113,34</b>

### Regulador



Régulateur  
Pressure reducer  
Regolatore

ROSCA THREAD	REFERENCIA PART N°	€
1/4" BSP	<b>REG 1/4</b>	<b>28,12</b>
1/2" BSP	<b>REG 1/2</b>	<b>58,05</b>
1" BSP	<b>REG 1</b>	<b>72,50</b>

### Filtro-regulador + lubricador compacto Metálico



Filtre-régulateur + lubrificateur compact  
Filter-pressure reducer + lubricant  
Filtro-regolatore di pressione+lubrificatore compatto

ROSCA THREAD	REFERENCIA PART N°	€
1/4" BSP	<b>FR+L 1/4 M</b>	<b>61,26</b>
1/2" BSP	<b>FR+L 1/2 M</b>	<b>123,81</b>
1" BSP	<b>FR+L 1 M</b>	<b>387,54</b>

### Manómetro



Manomètre  
Gauge  
Manometro

Ø ext	Descripción Description	ESCALA (bar) SCALE (bar)	REFERENCIA PART N°	€
43 mm	Dorsal	0 - 12	<b>MP4318012</b>	<b>9,28</b>
53 mm	Dorsal	0 - 12	<b>MP5318012</b>	<b>9,28</b>
53 mm	Vertical	0 - 12	<b>MR5318012</b>	<b>9,73</b>

### Filtro + regulador + lubricador (3 cuerpos) Metálico



Filtre + régulateur + lubrificateur (3 corps)  
Pressure reducer + lubricant + filter  
Filtro+regolatore+lubrificatore (3corpi)

ROSCA THREAD	REFERENCIA PART N°	€
1/4" BSP	<b>FRL 1/4 M</b>	<b>67,58</b>
1/2" BSP	<b>FRL 1/2 M</b>	<b>140,13</b>
1" BSP	<b>FRL 1 M</b>	<b>193,15</b>

### Soporte



Support  
Support bracket  
Supporto

ROSCA THREAD	REFERENCIA PART N°	€
Para regulador 1/2"	<b>SF 12</b>	<b>7,65</b>
Para regulador 1/4"	<b>SF 14</b>	<b>5,69</b>

## Accesorios neumáticos

Accessoires pneumatiques  
Pneumatic accessories  
Accessori pneumatici

Pipe

### Filtro serie Mini



Filtre  
Filter  
Filtro serie Mini

ROSCA THREAD	REFERENCIA PART N°	€
1/8" BSP	XF8	36,09
1/4" BSP	XF4	36,09

Fittings

### Lubricador serie Mini



Lubrificateur  
Atomised lubricant  
Lubrificatore serie Mini

ROSCA THREAD	REFERENCIA PART N°	€
1/8" BSP	XL8	43,96
1/4" BSP	XL4	43,96

Quick release  
couplings

### Filtro-regulador estandar serie Mini



Filtre-régulateur standard  
Filter-presure reducer  
Filtro-regolatore standard serie Mini

ROSCA THREAD	REFERENCIA PART N°	€
1/8" BSP	XFR8	56,64
1/4" BSP	XFR4	56,64

### Regulador serie Mini



Régulateur  
Presure reducer  
Regolatore serie Mini

ROSCA THREAD	REFERENCIA PART N°	€
1/8" BSP	XR8	32,37
1/4" BSP	XR4	32,37

Industrial elements

### Filtro-regulador + lubricador compacto serie Mini



Filtre-régulateur + lubrificateur compact  
Filter-presure reducer + lubricant  
Filtro-regolatore+lubrificatore-compacto serie Mini

ROSCA THREAD	REFERENCIA PART N°	€
1/8" BSP	XFRL8	102,79
1/4" BSP	XFRL4	102,79

Cylinders

### Soporte serie Mini



Support  
Support bracket  
Supporto serie Mini

Descripción Description	REFERENCIA PART N°	€
Para Regulador Mini	XSG	4,37

### Filtro + regulador + lubricador (3 cuerpos) serie Mini



Filtre + régulateur + lubrificateur (3 corps)  
Presure reducer + lubricant + filter  
Filtro+regolatore+lubrificatore (3 corpi) serie Mini

ROSCA THREAD	REFERENCIA PART N°	€
1/8" BSP	XFRL8	115,04
1/4" BSP	XFRL4	115,04

### Tuerca sujeción



Vis de soutien  
Ring unit  
Dado di fissaggio

Descripción Description	REFERENCIA PART N°	€
Para regulador	XRG	2,62

► Grupo filtración mini

Groupe de filtration mini | Micro serie | Gruppo di filtrazione mini

► **Filtro (XF...)** | Filtre  
Filter | Filtro

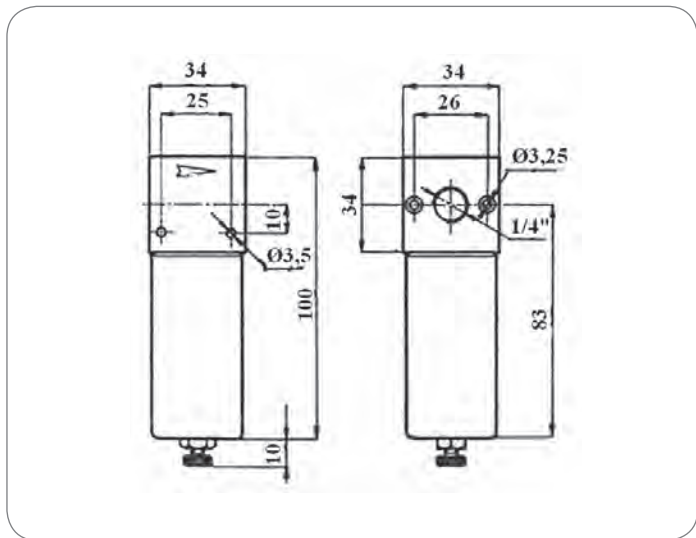

► **Filtro-regulador (XFR...)** | Filtre régulateur  
Filter-pressure reducer | Filtro-regolatore

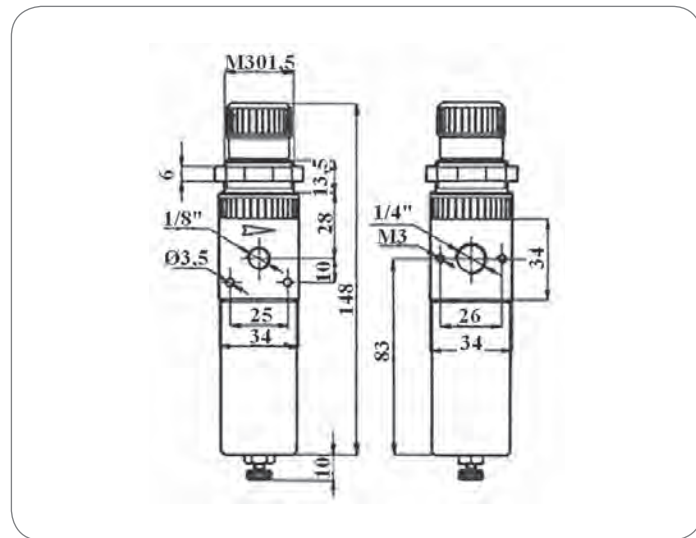

► **Filtro-regulador + lubricador compacto (XFRUL...)**  
Filtre-régulateur + lubrificateur compact  
Compact filter-pressure reducer + lubricant  
Filtro-regolatore + lubrificatore compatto

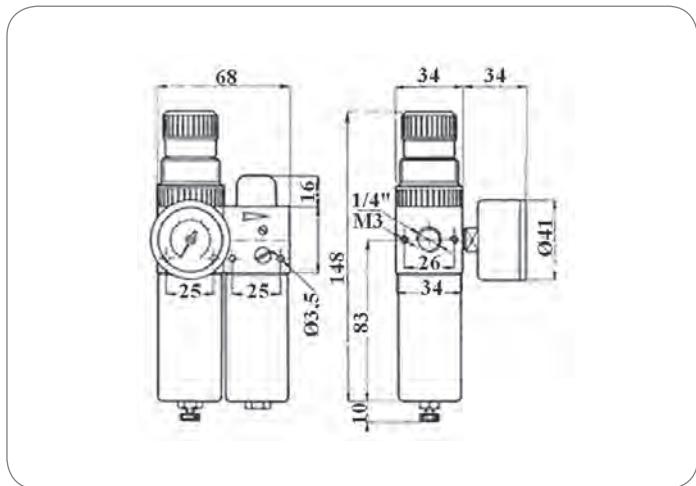

► **Filtro + regulador + lubricador (3 cuerpos) (XFRUL...)**  
Filtre + régulateur + lubrificateur (3 corps)  
Filter + pressure reducer + lubricant (3 parts)  
Filtro + regolatore + lubrificatore (3 corpi)

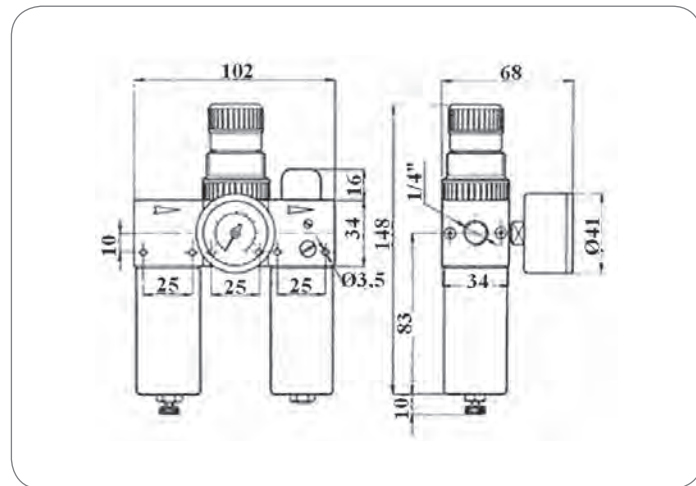

► **Lubricador compacto (XL...)** | Régulateur  
Atomised lubricant | Lubrificatore

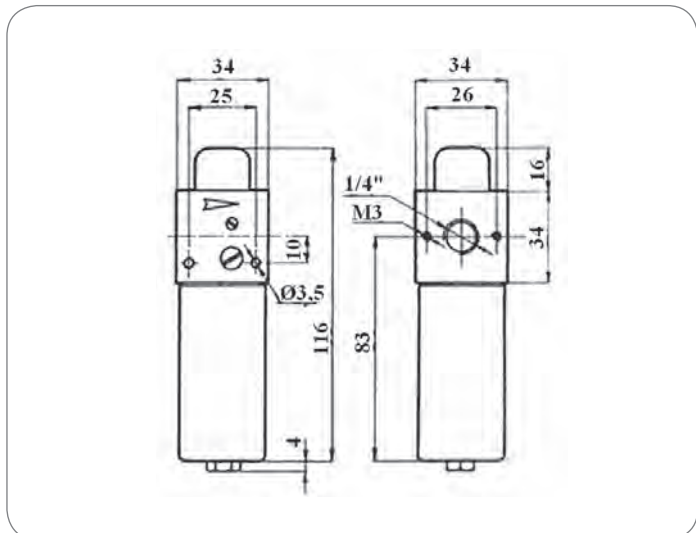

► **Regulador (XR...)** | Régulateur  
Pressure reducer | Regolatore

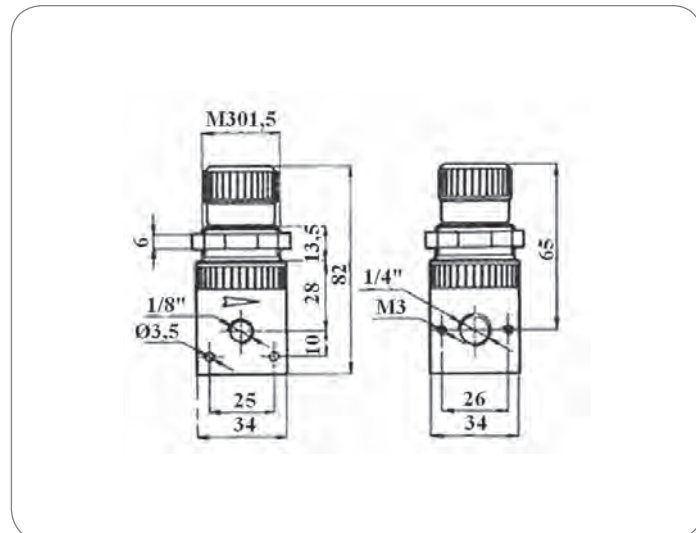

## Accesorios neumáticos

Accessoires pneumatiques  
Pneumatic accessories  
Accessori pneumatici

Pipe

### Válvula bola mini H-H



Robinet mini femelle-femelle  
Ball valve female - female  
Valvola a sfera mini F-F

ROSCA THREAD	REFERENCIA PART N°	€
1/8"	6300 1/8	8,99
1/4"	6300 1/4	9,36
3/8"	6300 3/8	9,80
1/2"	6300 1/2	13,45

Fittings

### Válvula bola mini hexagonal H-H



Robinet mini hexagonal femelle-femelle  
Mini ball valve female - female  
Valvola a sfera mini esagonale F-F

ROSCA THREAD	REFERENCIA PART N°	€
1/8"	6065 1/8	7,64
1/4"	6065 1/4	7,64
3/8"	6065 3/8	7,33
1/2"	6065 1/2	9,24

Quick release couplings

### Válvula bola mini M-H



Robinet mini mâle-femelle  
Ball valve male - female  
Valvola a sfera mini M-F

ROSCA THREAD	REFERENCIA PART N°	€
1/8"	6310 1/8	8,99
1/4"	6310 1/4	8,81
3/8"	6310 3/8	9,70
1/2"	6310 1/2	13,36

Industrial elements

### Regulador flujo unidireccional



Régulateurs de débit unidirectionnels  
Uni-directional flow regulator  
Regolatore di flusso unidirezionale

ROSCA THREAD	REFERENCIA PART N°	€
1/8"	8850 1/8	14,68
1/4"	8850 1/4	19,58
3/8"	8850 3/8	39,62
1/2"	8850 1/2	43,38

Cylinders

### Regulador flujo bidireccional



Régulateurs de débit bidirectionnels  
Bi-directional flow regulator  
Regolatore di flusso bidirezionale

ROSCA THREAD	REFERENCIA PART N°	€
1/8"	8860 1/8	14,68
1/4"	8860 1/4	19,58
3/8"	8860 3/8	39,62
1/2"	8860 1/2	43,38

### Regulador flujo cilíndrico



Régulateurs de débit cylindriques  
Flow regulator for cylinder  
Regolatore di flusso per cilindro

TUBO PIPE	ROSCA THREAD	REFERENCIA PART N°	€
6 mm	1/8"	8953 6 1/8	17,91
6 mm	1/4"	8953 6 1/4	19,38
8 mm	1/8"	8953 8 1/8	17,91
8 mm	1/4"	8953 8 1/4	19,38
8 mm	3/8"	8953 8 3/8	28,85
10 mm	1/4"	8953 10 1/4	19,98
10 mm	3/8"	8953 10 3/8	29,44
12 mm	3/8"	8953 12 3/8	29,44
12 mm	1/2"	8953 12 1/2	37,71

### Regulador flujo cilíndrico rápido



Régulateurs de débit rapides cylindriques  
Quick flow regulator for cylinder  
Regolatore di flusso rapido per cilindro

TUBO PIPE	ROSCA THREAD	REFERENCIA PART N°	€
6/4 mm	1/8"	8965 6/4 1/8	15,73
6/4 mm	1/4"	8965 6/4 1/4	17,69
8/6 mm	1/8"	8965 8/6 1/8	15,73
8/6 mm	1/4"	8965 8/6 1/4	17,69
8/6 mm	3/8"	8965 8/6 3/8	25,77
10/8 mm	1/4"	8965 10/8 1/4	18,21
10/8 mm	3/8"	8965 10/8 3/8	25,92
12/10 mm	3/8"	8965 12/10 3/8	26,63
12/10 mm	1/2"	8965 12/10 1/2	33,51

## Accesorios neumáticos

Accessoires pneumatiques  
Pneumatic accessories  
Accessori pneumatici

### Válvula seguridad taraje fijo



Vannes de sécurité - tarage fixe

Relief valve

Valvola di sicurezza a taratura fissa

ROSCA THREAD	TARAJE (BAR) PRESSURE (Bar)	REFERENCIA PART N°	€
1/8"	8	VSN 1/8 8	6,02
1/8"	10	VSN 1/8 10	6,02
1/8"	12	VSN 1/8 12	6,59
1/8"	15	VSN 1/8 15	6,59
1/4"	8	VSN 1/4 8	6,59
1/4"	10	VSN 1/4 10	6,59
1/4"	12	VSN 1/4 12	7,30
1/4"	15	VSN 1/4 15	7,30
3/8"	8	VSN 3/8 8	12,96
3/8"	10	VSN 3/8 10	12,96
3/8"	12	VSN 3/8 12	14,31
3/8"	15	VSN 3/8 15	14,31
1/2"	8	VSN 1/2 8	16,36
1/2"	10	VSN 1/2 10	16,36
1/2"	12	VSN 1/2 12	17,99
1/2"	15	VSN 1/2 15	17,99
3/4"	8	VSN 3/4 8	35,77
3/4"	10	VSN 3/4 10	35,77
3/4"	12	VSN 3/4 12	39,39
3/4"	15	VSN 3/4 15	39,39
1"	8	VSN 1 8	60,92
1"	10	VSN 1 10	60,92
1"	12	VSN 1 12	67,02
1"	15	VSN 1 15	67,02

### Válvula seguridad regulable



Vannes de sécurité réglable

Adjustable relief valve

Valvola di sicurezza a taratura regolabile

ROSCA THREAD	TARAJE (BAR) PRESSURE (Bar)	REFERENCIA PART N°	€
1/8"	8 - 12	VS 1/8 8-12	7,44
1/8"	13 - 16	VS 1/8 13-16	7,44
1/4"	8 - 12	VS 1/4 8-12	8,08
1/4"	13 - 16	VS 1/4 13-16	8,08
3/8"	8 - 12	VS 3/8 8-12	8,08
3/8"	13 - 16	VS 3/8 13-16	8,93
1/2"	8 - 12	VS 1/2 8-12	15,94
1/2"	13 - 16	VS 1/2 13-16	15,94
3/4"	8 - 12	VS 3/4 8-12	17,50
3/4"	13 - 16	VS 3/4 13-16	17,50
1"	8 - 12	VS 1 8-12	20,19
1"	13 - 16	VS 1 13-16	20,19

### Antiretorno H-H



Antiretour femelle-femelle

Non-return valve female-female

Valvola Antiritorno F-F

ROSCA THREAD	REFERENCIA PART N°	€
1/8"	6062 1/8	9,24
1/4"	6062 1/4	11,42
3/8"	6062 3/8	24,89
1/2"	6062 1/2	25,58

### Válvula retención con membrana



Vanne de retention avec membrane

Retention valve with membrane

Valvola di ritegno con membrana

ROSCA THREAD	REFERENCIA PART N°	€
3/8"	6034 3/8	10,01
1/2"	6034 1/2	10,06
3/4"	6034 3/4	14,19
1"	6034 1	18,42

## Accesorios neumáticos

Accessoires pneumatiques  
Pneumatic accessories  
Accessori pneumatici

Pipe

### Válvula de escape rápido



Vannes d'échappement rapide  
Quick exhaust valves  
Valvola di scarico rapido

ROSCA THREAD	REFERENCIA PART N°	€
1/8"	6050 1/8	10,90
1/4"	6050 1/4	13,38
3/8"	6050 3/8	15,78
1/2"	6050 1/2	22,61

### Válvula de paso corredera 3 vías



Vannes de passage tiroir 3 voies  
Sleeve valves  
Valvola di passaggio 3 vie

ROSCA THREAD	REFERENCIA PART N°	€
1/8"	6060 1/8	16,49
1/4"	6060 1/4	20,50
3/8"	6060 3/8	25,09
1/2"	6060 1/2	31,59

Fittings

### Grifo purga



Robinet de purge  
Drain cock  
Rubinetto di sfiato

ROSCA THREAD	REFERENCIA PART N°	€
1/2"	16A 1/2	3,76
1/4"	16A 1/4	2,94
1/8"	16A 1/8	2,63
3/8"	16A 3/8	3,07

Quick release couplings

Industrial elements

### Silenciador bronce largo



Silencieux en bronze long  
Nickel-plated brass silencer (long)  
Silenziatore lungo in bronzo

ROSCA THREAD	REFERENCIA PART N°	€
1/8"	SE 1/8	0,52
1/4"	SE 1/4	3,42
3/8"	SE 3/8	6,08
1/2"	SE 1/2	7,95

### Silenciador acero



Silencieux acier  
Steel silencer  
Silenziatore in acciaio

ROSCA THREAD	REFERENCIA PART N°	€
1/8"	SFE 1/8	1,76
1/4"	SFE 1/4	2,00
3/8"	SFE 3/8	0,89
1/2"	SFE 1/2	1,33

Cylinders

### Silenciador bronce corto



Silencieux en bronze court  
Nickel-plated brass silencer (short)  
Silenziatore corto in bronzo

ROSCA THREAD	REFERENCIA PART N°	€
1/8"	SCQ 1/8	2,00
1/4"	SCQ 1/4	2,92
3/8"	SCQ 3/8	5,30
1/2"	SCQ 1/2	7,80

### Silenciador regulable



Silencieux  
Regulator silencer  
Silenziatore regolabile

ROSCA THREAD	REFERENCIA PART N°	€
1/8"	SVE 1/8	4,77
1/4"	SVE 1/4	5,11
3/8"	SVE 3/8	8,77
1/2"	SVE 1/2	9,15

## Accesorios neumáticos

Accessoires pneumatiques  
Pneumatic accessories  
Accessori pneumatici

### Accesorios para montaje



Accessoires pour montage  
Accessories for assembly  
Accessori per l'assemblaggio

Descripción Description	REFERENCIA PART N°	€
Llave de desmontaje	50990	2,08
Cortatubos poliamida	TOTBMW	15,14

### Pistolas



Pistolets  
Guns  
Pistola

Descripción Description	REFERENCIA PART N°	€
Botón	ESTO 600B	42,83
Gatillo	ESTO 610G	48,18
Alargadera Pistola sopladora	ESTO 630	12,14
Alargadera Pistola Aspiradora	ESTO E640	20,45

## Válvulas neumáticas

Vannes pneumatiques  
Pneumatic valves  
Valvole pneumatiche

Pipe

### Válvulas con acc. neumático - 5/2 monoestable



Vannes avec actionnement pneum. mono-stable

Pneumatically actuated - pilot spring

Valvole con azionamento pneumatico -5/2 monoestabile

ROSCA THREAD	REFERENCIA PART N°	€
1/8"	NEU100000	68,30
1/4"	NEU100005	68,30
3/8"	NEU100010	95,57
1/2"	NEU100015	235,54

Fittings

### Válvulas con acc. eléctrico - 5/2 monoestable

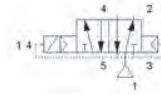

Vannes avec actionnement électrique mono-stable

Solenoid operated - pilot spring

Valvole con azionamento elettrico - 5/2 monoestabile

ROSCA THREAD	REFERENCIA PART N°	€
1/8"	NEU100070	15,12
1/4"	NEU100075	19,94
3/8"	NEU100080	19,94
1/2"	NEU100085	46,36

Sin Bobinas y sin Conectores // Sans Bobines et sans Connecteurs // Without Coils and without Connectors // Senza bobine e senza Connettori

Quick release couplings

### Válvulas con acc. neumático - 5/2 biestable

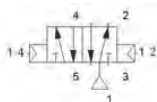

Vannes avec actionnement pneum. bi-stable

Pneumatically actuated - double pilot

Valvole con azionamento pneumatico-5/2 bistabile

ROSCA THREAD	REFERENCIA PART N°	€
1/8"	NEU100020	67,47
1/4"	NEU100025	67,47
3/8"	NEU100030	93,60
1/2"	NEU100035	233,57

Industrial elements

### Válvulas con acc. eléctrico - 5/2 biestable



Vannes avec actionnement électrique bi-stable

Solenoid operated - double pilot

Valvole con azionamento elettrico -5/2 bistabile

ROSCA THREAD	REFERENCIA PART N°	€
1/8"	NEU100090	27,59
1/4"	NEU100095	27,59
3/8"	NEU100100	33,96
1/2"	NEU100105	58,33

Sin Bobinas y sin Conectores // Sans Bobines et sans Connecteurs // Without Coils and without Connectors // Senza bobine e senza Connettori

Cylinders

### Válvulas con acc. neumático - 5/3 centro cerrado

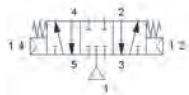

Vannes avec actionnement pneum. centre fermé

Pneumatically actuated - centered closed

Valvole con azionamento pneumatico-5/3centro chiuso

ROSCA THREAD	REFERENCIA PART N°	€
1/8"	NEU100040	103,01
1/4"	NEU100045	130,35
1/2"	NEU100050	316,46

### Válvulas con acc. eléctrico - centro 5/3 cerrado

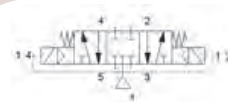

Vannes avec actionnement électrique centre fermé

Solenoid operated - centered closed

Valvole con azionamento elettrico - 5/3 centro chiuso

ROSCA THREAD	REFERENCIA PART N°	€
1/8"	NEU100110	59,11
1/4"	NEU100115	78,45
1/2"	NEU100120	101,68

Sin Bobinas y sin Conectores // Sans Bobines et sans Connecteurs // Without Coils and without Connectors // Senza bobine e senza Connettori

### Válvulas con acc. neumático - 5/3 centro abierto



Vannes avec actionnement pneum. centre ouvert

Pneumatically actuated - centered exhausted

Valvole con azionamento pneumatico -5/3 centro aperto

ROSCA THREAD	REFERENCIA PART N°	€
1/8"	NEU100055	103,01
1/4"	NEU100060	130,35
1/2"	NEU100065	316,46

### Válvulas con acc. eléctrico - 5/3 centro abierto

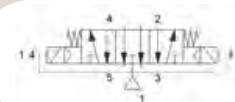

Vannes avec actionnement électrique centre ouvert

Solenoid operated - centered exhausted

Valvole con azionamento elettrico - 5/3 centro aperto

ROSCA THREAD	REFERENCIA PART N°	€
1/8"	NEU100125	62,09
1/4"	NEU100130	62,09
1/2"	NEU100135	101,68

Sin Bobinas y sin Conectores // Sans Bobines et sans Connecteurs // Without Coils and without Connectors // Senza bobine e senza Connettori



## Válvulas neumáticas

Vannes pneumatiques  
Pneumatic valves  
Valvole pneumatiche

### Válvulas con acc. eléctrico 3/2 - n.a.

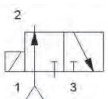

Vannes avec actionnement électrique - n.o.  
Solenoid operated 3/2 normally open  
Valvole con azionamento elettrico 3/2 n.a

ROSCA THREAD	REFERENCIA PART N°	€
1/8"	NEU100620	18,94
1/4"	NEU100625	15,97
1/2"	NEU100630	46,29
3/4"	NEU100635	534,94

### Válvulas con acc. palanca - 5/3 c.c. biestable

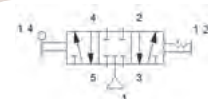

Vannes avec actionnement levier - 5/3 c.f. bi-stables  
Lever - 3 stable positions 5/3 c.c.  
Valvole con azionamento a leva- 5/3 centro chiuso bistabile

ROSCA THREAD	Descripción Description	REFERENCIA PART N°	€
1/4"	Talla B	NEU100546	139,09
1/8"	Talla B	NEU100565	38,40
1/4"	Talla A	NEU100570	38,47
3/8"	-	NEU100575	43,99

### Válvulas con acc. palanca - 5/2 monoestable

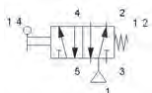

Vannes avec actionnement levier - 5/2 mono-stables  
Lever - pilot-spring 5/2 ways  
Valvole con azionamento a leva-5/2 monostabile

ROSCA THREAD	REFERENCIA PART N°	€
1/8"	NEU100505	29,47
1/4"	NEU100510	43,14
3/8"	NEU100515	43,14

### Válvulas con acc. eléctrico 3/2 - n.c.

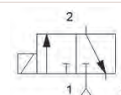

Vannes avec actionnement électrique - n.f.  
Solenoid operate 3/2 normally closed  
Valvole con azionamento elettrico 3/2 n.c

ROSCA THREAD	REFERENCIA PART N°	€
1/8"	NEU100600	19,16
1/4"	NEU100605	19,16
1/2"	NEU100610	30,77
3/4"	NEU100615	534,94

### Válvulas con acc. palanca - 5/2 biestable

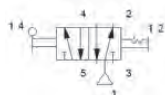

Vannes avec actionnement levier - 5/2 bi-stables  
Lever - double-pilot 5/2 ways  
Valvole con azionamento a leva bistabile

ROSCA THREAD	REFERENCIA PART N°	€
1/8"	NEU100520	25,64
1/4"	NEU100525	22,10
3/8"	NEU100530	25,29

### Válvulas con acc. palanca - 5/3 c.a. monoestable

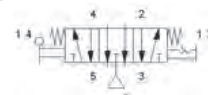

Vannes avec actionnement levier - 5/3 c.o. mono-stables  
Lever - pilot-spring 5/3 c.o.  
Valvole con azionamento a leva- 5/3 centro aperto monostabile

ROSCA THREAD	REFERENCIA PART N°	€
1/8"	NEU100550	34,78
1/4"	NEU100555	43,00
3/8"	NEU100560	43,00

### Válvulas con acc. palanca - 5/3 c.c. monoestable

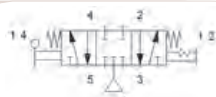

Vannes avec actionnement levier - 5/3 c.f. mono-stables  
Lever pilot-spring 5/3 c.c.  
Valvole con azionamento a leva- 5/3 centro chiuso monostabile

ROSCA THREAD	REFERENCIA PART N°	€
1/8"	NEU100535	34,78
1/4"	NEU100540	43,00
3/8"	NEU100545	43,00

### Válvulas con acc. palanca - 5/3 c.a. biestable

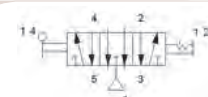

Vannes avec actionnement levier - 5/3 c.o. bi-stables  
Lever - 3 stable positions 5/3 c.o.  
Valvole con azionamento a leva-5/3 centro aperto bistabile

ROSCA THREAD	REFERENCIA PART N°	€
1/8"	NEU100580	34,78
1/4"	NEU100585	43,00
3/8"	NEU100590	43,00

## Válvulas neumáticas

Vannes pneumatiques  
Pneumatic valves  
Valvole pneumatiche

Pipe

Fittings

Quick release couplings

Industrial elements

Cylinders

### Colectores



Collecteurs  
In line manifolds  
Collettore

ROSCA THREAD	Nº DE SALIDAS N. EXITS	REFERENCIA PART N°	€
1/8"	2	NEU100140	45,27
1/8"	3	NEU100145	52,71
1/8"	4	NEU100150	60,36
1/8"	5	NEU100155	68,02
1/8"	6	NEU100160	77,57
1/4"	2	NEU100165	48,99
1/4"	3	NEU100170	56,64
1/4"	4	NEU100175	64,30
1/4"	5	NEU100180	72,17
1/4"	6	NEU100185	79,83
3/8"	2	NEU100190	52,71
3/8"	3	NEU100195	60,36
3/8"	4	NEU100200	68,02
3/8"	5	NEU100205	75,89
3/8"	6	NEU100210	83,54

### Bobinas y conectores



Bobines et connecteurs  
Coil and connector  
Bobine e connettori

Descripción Description	REFERENCIA PART N°	€
Conector Estandar	NEU100215	2,62
Bobina a 12VDC	NEU100220	8,53
Bobina a 24 VDC	NEU100225	8,53
Bobina a 24/50 V	NEU100230	8,53
Bobina a 110/50 V	NEU100235	8,53
Bobina a 220/50 V	NEU100240	8,53

### Válvulas pulsador raso



Vannes à poussoir court  
Shrouded push button  
Valvole a pulsante raso

ROSCA THREAD	Descripción Description	REFERENCIA PART N°	€
1/8"	2/2 N.C.	NEU100260	82,45
1/8"	2/2 N.C.	NEU100265	82,45
1/8"	2/2 N.A.	NEU100270	90,98
1/8"	2/2 N.A.	NEU100275	90,98
1/8"	3/2 N.C.	NEU100280	82,45
1/8"	3/2 N.C.	NEU100285	82,45
1/8"	3/2 N.A.	NEU100290	90,98
1/8"	3/2 N.A.	NEU100295	90,98

Esquemas págs 369-370 // Diagrammes p. 369-370 // Diagrams p. 369-370 // Diagrammi p. 369-370

### Válvulas pulsador normal



Vannes à poussoir normal  
Push button  
Valvole a pulsante normale

ROSCA THREAD	Descripción Description	REFERENCIA PART N°	€
1/8"	2/2 N.C.	NEU100300	82,45
1/8"	2/2 N.A.	NEU100305	90,98
1/8"	3/2 N.C.	NEU100310	82,45
1/8"	3/2 N.A.	NEU100315	90,98

Esquemas págs 369-370 // Diagrammes p. 369-370 // Diagrams p. 369-370 // Diagrammi p. 369-370

### Válvulas pulsador emergencia



Vannes à poussoir d'urgence  
Head push button  
Valvole a pulsante di emergenza

ROSCA THREAD	Descripción Description	REFERENCIA PART N°	€
1/8"	2/2 N.C.	NEU100320	14,17
1/8"	3/2 N.C.	NEU100330	19,69

Esquemas págs 369-370 // Diagrammes p. 369-370 // Diagrams p. 369-370 // Diagrammi p. 369-370

## Válvulas neumáticas

Vannes pneumatiques  
Pneumatic valves  
Valvole pneumatiche

### Válvulas a leva - 3/2 biestable



Vannes à léva  
Lever 3/2 ways  
Valvole a leva bistabile

ROSCA THREAD	REFERENCIA PART N°	€
1/8"	NEU100245	90,98
1/2"	NEU100255	8,53

### Válvulas selectoras palanca giratoria



Vannes sélectrices à levier tournant  
Selector valves rotating lever  
Valvole seletttrice a leva girevole

ROSCA THREAD	Descripción Description	REFERENCIA PART N°	€
1/8"	2/2 Biestable	NEU100340	14,17
1/8"	3/2 Biestable	NEU100345	25,57
1/8"	5/2 Biestable	NEU100350	20,54

Esquemas págs 369-370 // Diagrammes p. 369-370 // Diagrams p. 369-370 // Diagrammi p. 369-370

### Válvulas de rodillo unidireccional



Vannes à rouleau unidirectionnel  
One way roller lever  
Valvola a rotella unidirezionale

ROSCA THREAD	Descripción Description	REFERENCIA PART N°	€
1/8"	2/2 Monoestable	NEU100360	55,99
1/8"	3/2 Monoestable	NEU100365	79,17

Esquemas págs 369-370 // Diagrammes p. 369-370 // Diagrams p. 369-370 // Diagrammi p. 369-370

### Válvulas de rodillo bidireccional



Vannes à rouleau bidirectionnel  
Fixed roller  
Valvola a rotella bidirezionale

ROSCA THREAD	Descripción Description	REFERENCIA PART N°	€
1/8"	2/2 Monoestable	NEU100370	14,17
1/8"	3/2 Monoestable N.C.	NEU100375	19,76
1/4"	3/2 Monoestable N.C.	NEU100380	19,76
1/8"	3/2 Monoestable N.A.	NEU100385	52,71
1/8"	5/2 Monoestable	NEU100390	21,96
1/4"	5/2 Monoestable	NEU100395	21,96

Esquemas págs 369-370 // Diagrammes p. 369-370 // Diagrams p. 369-370 // Diagrammi p. 369-370

## Válvulas neumáticas

Vannes pneumatiques  
Pneumatic valves  
Valvole pneumatiche

### Válvulas tetón



Vanne fin de course

Pin valve

Valvole di fine corsa

ROSCA THREAD	Descripción Description	REFERENCIA PART N°	€
1/8"	2/2 Monoestable	NEU100400	37,40
1/8"	3/2 Monoestable N.C.	NEU100405	37,40
1/4"	3/2 Monoestable N.C.	NEU100410	53,58
1/2"	3/2 Monoestable N.C.	NEU100415	92,07
1/8"	3/2 Monoestable N.A.	NEU100420	44,40
1/4"	3/2 Monoestable N.A.	NEU100425	44,40
1/2"	3/2 Monoestable N.A.	NEU100430	98,85
1/8"	5/2 Biestable	NEU100435	78,95
1/4"	5/2 Biestable	NEU100440	109,57

Esquemas págs 369-370 // Diagrammes p. 369-370 // Diagrams p. 369-370 // Diagrammi p. 369-370

### Microválvulas pulsador



Micro-valves à bouton

Push button microvalves

Microvalvole a pulsante

Descripción Description	REFERENCIA PART N°	€
3/2 Monoestable (Raso)	NEU100445	47,02
3/2 Monoestable (Emergencia)	NEU100450	62,33
3/2 Biestable (Emergencia)	NEU100455	75,23

Esquemas págs 369-370 // Diagrammes p. 369-370 // Diagrams p. 369-370 // Diagrammi p. 369-370

### Microválvulas a llave



Micro-valves à clé

Key microvalves

Microvalvole a chiave

Descripción Description	REFERENCIA PART N°	€
3/2 Biestable	NEU100470	83,76
5/3 C.A.	NEU100475	113,07

Esquemas págs 369-370 // Diagrammes p. 369-370 // Diagrams p. 369-370 // Diagrammi p. 369-370

### Microválvulas tetón



Micro-valves fin de course

Pin microvalves

Microvalvole di fine corsa

Descripción Description	REFERENCIA PART N°	€
3/2 Monoestable	NEU100485	29,31

Esquemas págs 369-370 // Diagrammes p. 369-370 // Diagrams p. 369-370 // Diagrammi p. 369-370

### Microválvulas selectora



Micro-valves sélectrices

Lever microvalves

Microvalvole seletttrici

Descripción Description	REFERENCIA PART N°	€
3/2 Biestable	NEU100460	61,24
5/3 C.A.	NEU100465	90,32

Esquemas págs 369-370 // Diagrammes p. 369-370 // Diagrams p. 369-370 // Diagrammi p. 369-370

### Microválvulas de rodillo



Micro-valves à rouleau

Roller microvalves

Microvalvole a rotella

Descripción Description	REFERENCIA PART N°	€
3/2 Monoestable (Bidireccional)	NEU100490	35,43
3/2 Monoestable (Unidireccional)	NEU100495	40,02

Esquemas págs 369-370 // Diagrammes p. 369-370 // Diagrams p. 369-370 // Diagrammi p. 369-370

## Válvulas neumáticas

Vannes pneumatiques  
Pneumatic valves  
Valvole pneumatiche

### Pedales neumáticos



Pédales pneumatiques  
Pneumatic foot pedal  
Pedali pneumatici

Descripción Description	REFERENCIA PART N°	€
5/2 Biestable con protección	<b>PC 1/4 B</b>	<b>51,50</b>
5/2 Monoestable con protección	<b>PC 1/4 M</b>	<b>47,75</b>
5/2 Monoestable sin protección	<b>PS 1/4</b>	<b>37,26</b>

Esquemas págs 369-370 // Diagrammes p. 369-370 // Diagrams p. 369-370 // Diagrammi p. 369-370

### Pedales eléctricos



Pédales électriques  
Electric foot pedal  
Pedali elettrici

Descripción Description	REFERENCIA PART N°	€
Sin protección	<b>PML</b>	<b>32,05</b>

Esquemas págs 369-370 // Diagrammes p. 369-370 // Diagrams p. 369-370 // Diagrammi p. 369-370

### Nebulizador



Nébulisateur  
Nebulizer  
Nebulizzatore

Descripción Description	REFERENCIA PART N°	€
-	<b>NEU100500</b>	<b>133,63</b>

## Válvulas neumáticas

Vannes pneumatiques  
Pneumatic valves  
Valvole pneumatiche

Pipe

### Válvula corte baja presión n.a.(sin bob)



Vanne à clapet basse pression n.o. (sans bobine)

Low pressure valve usually opened (without coil and connector)  
Valvole bassa pressione normalmente aperta (senza bobina e senza connettore)

ROSCA THREAD	Pr Min (bar)	Pr Máx (bar) Pr Max (bar)	REFERENCIA PART N°	€
1/4"	0,15	16 (VAC) / 10 (VDC)	<b>VCBP14NA</b>	<b>85,19</b>
3/8"	0,15	16 (VAC) / 10 (VDC)	<b>VCBP38NA</b>	<b>100,31</b>
1/2"	0,15	16 (VAC) / 10 (VDC)	<b>VCBP12NA</b>	<b>101,77</b>
3/4"	0,15	12 (VAC) / 10 (VDC)	<b>VCBP34NA</b>	<b>123,08</b>
1"	0,15	12 (VAC) / 18 (VDC)	<b>VCBP1NA</b>	<b>171,00</b>
1" 1/4	0,15	10 (VAC) / 10 (VDC)	<b>VCBP114NA</b>	<b>253,35</b>
1" 1/2	0,15	10 (VAC) / 10 (VDC)	<b>VCBP112NA</b>	<b>364,55</b>
2"	0,15	10 (VAC) / 10 (VDC)	<b>VCBP2NA</b>	<b>502,47</b>

Fittings

### Válvula corte baja presión n.c.(sin bob)



Vanne à clapet basse pression n.f. (sans bobine)

Low pressure valve usually closed (without coil and connector)  
Valvole bassa pressione normalmente chiusa (senza bobina e senza connettore)

ROSCA THREAD	Pr Min (bar)	Pr Máx (bar) Pr Max (bar)	REFERENCIA PART N°	€
1/4"	0,15	18 (VAC) / 16 (VDC)	<b>VCBP14NC</b>	<b>54,62</b>
3/8"	0,15	18 (VAC) / 16 (VDC)	<b>VCBP38NC</b>	<b>75,38</b>
1/2"	0,15	18 (VAC) / 16 (VDC)	<b>VCBP12NC</b>	<b>77,04</b>
3/4"	0,15	16 (VAC) / 13 (VDC)	<b>VCBP34NC</b>	<b>102,38</b>
1"	0,15	12 (VAC) / 10 (VDC)	<b>VCBP1NC</b>	<b>160,88</b>
1" 1/4	0,15	10 (VAC) / 10 (VDC)	<b>VCBP114NC</b>	<b>430,25</b>
1" 1/2	0,15	10 (VAC) / 10 (VDC)	<b>VCBP112NC</b>	<b>364,55</b>
2"	0,15	10 (VAC) / 10 (VDC)	<b>VCBP2NC</b>	<b>550,08</b>

Quick release  
couplings

Industrial elements

Cylinders

### Válvula cabina



Valve de cabine  
Cabin valve  
Valvole cabina

Descripción Description	REFERENCIA PART N°	€
2 Vias	<b>A6103000000</b>	<b>55,62</b>

### Bobinas y conectores válvula corte



Bobines et connecteurs

Coils and connector  
Bobina e connettori

Descripción Description	REFERENCIA PART N°	€
Bobina Pequeña 12 VDC	<b>C1-12CC</b>	<b>22,95</b>
Bobina Pequeña 24/50 V	<b>C1-24CA</b>	<b>22,95</b>
Bobina Pequeña 24 VDC	<b>C1-24CC</b>	<b>22,95</b>
Bobina Pequeña 48/50 V	<b>C1-48CA</b>	<b>22,95</b>
Bobina Pequeña 110/50 V	<b>C1-110CA</b>	<b>22,95</b>
Bobina Pequeña 220/50 V	<b>C1-220CA</b>	<b>15,63</b>
Bobina Grande 12 VDC	<b>C3-12CC</b>	<b>20,94</b>
Bobina Grande 24/50 V	<b>C3-24CA</b>	<b>20,94</b>
Bobina Grande 24 VDC	<b>C3-24CC</b>	<b>20,93</b>
Bobina Grande 48/50 V	<b>C3-48CA</b>	<b>31,55</b>
Bobina Grande 110/50 V	<b>C3-110CA</b>	<b>31,55</b>
Bobina Grande 220/50 V	<b>C3-220CA</b>	<b>20,94</b>
Conector CC/CA para bobina mini	<b>CONC1</b>	<b>1,76</b>
Conector CC/CA para bobina grande	<b>CONC3</b>	<b>2,24</b>

Bobina pequeña desde 3/8" hasta 1". Bobina grande 1/4" y a partir de 1"1/4 / Petite bobine jusqu'à 1".  
Grande bobine 1/4" et à partir de 1"1/4 / Small coil up to 1". Big coil 1/4" and all from 1"1/4 / Falta italiano

# Válvulas neumáticas

Vannes pneumatiques | Pneumatic valves | Valvole pneumatiche

## ▶ Válvulas Pulsador Raso | Valves à pousoir court | Shrouded push button | Valvole a pulsante

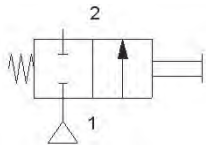

NEU100260 - NEU100265

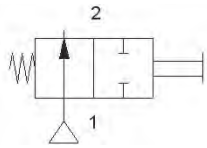

NEU100270 - NEU100275

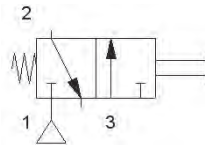

NEU100280 - NEU100285

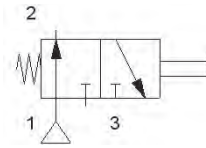

NEU100290 - NEU100295

## ▶ Válvulas Pulsador Normal | Valves à pousoir normal | Push button | Valvole a pulsante

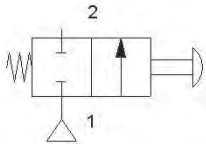

NEU100300

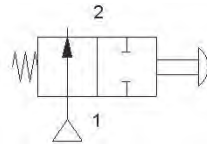

NEU100305

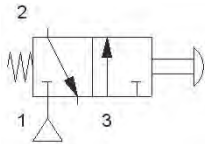

NEU100310

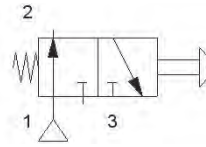

NEU100315

## ▶ Válvulas Pulsador Emergencia | Valves à pousoir d'urgence | Head push button | Valvole a pulsante di emergenza

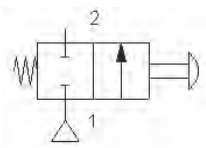

NEU100320

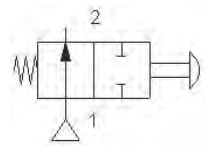

NEU100325

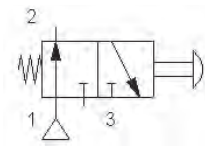

NEU100330

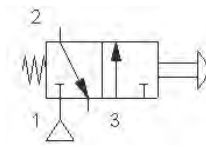

NEU100335

## ▶ Válvulas Selectoras Palanca Giratoria | Valves sélectrice à levier tournant | Selector valves rotating lever | Valvole seletttrice a leva girevole

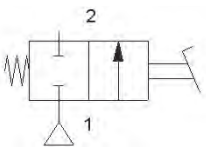

NEU100340

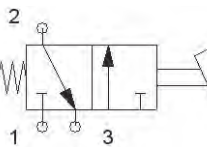

NEU100345

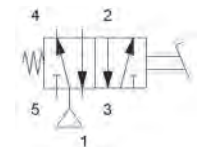

NEU100350

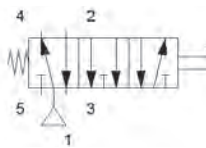

NEU100355

## ▶ Válvulas de Rodillo Unidireccional | Valves à rouleau unidirectionnel | One way roller lever | Valvola a rotella unidirezionale

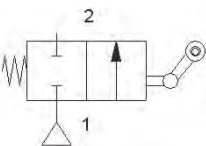

NEU100360

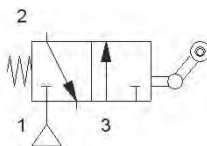

NEU100365

## ▶ Válvulas de Rodillo Bidireccional | Valves à rouleau bidirectionnel | Fixer roller | Valvola a rotella bidirezionale

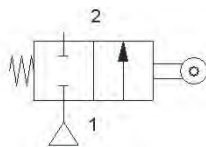

NEU100370

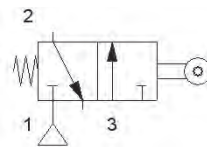

NEU100375 - NEU100380

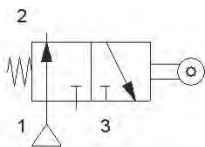

NEU100385

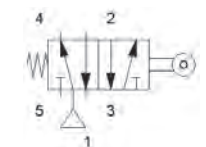

NEU100390 - NEU100395

## ▶ Válvulas de Tetón | Valve fin de course | Pin valve | Valvole di fine corsa

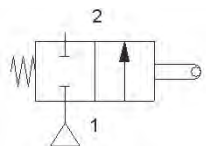

NEU100400

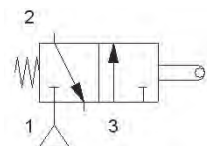

NEU100405 - NEU100410 - NEU100415

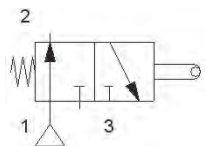

NEU100420 - NEU100425 - NEU100430

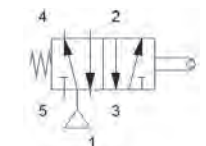

NEU100435 - NEU100440

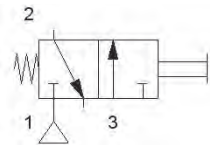
▶ **Microválvulas Pulsador** | Micro-valves à bouton | Push button microvalves | Microvalvole a pulsante

NEU100445

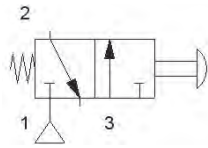

NEU100450

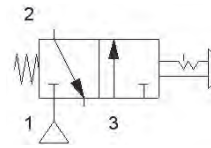

NEU100455

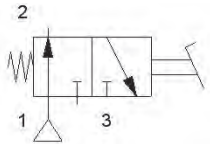
▶ **Microválvulas Selectora** | Micro-valves sélectrice | Lever microvalves | Microvalvole selettici

NEU100460

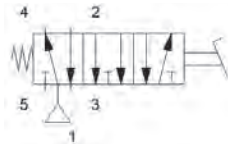

NEU100465

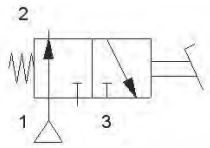
▶ **Microválvulas a Llave** | Micro-valves à clé | Key microvalves | Microvalvole a chiave

NEU100470

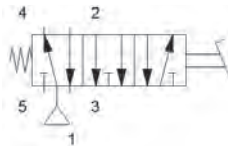

NEU100475

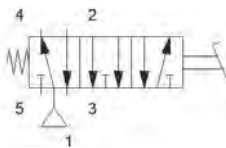
▶ **Microválvulas Manual** | Micro-valves manuelles | Joystick microvalves | Microvalvole manuale

NEU100480

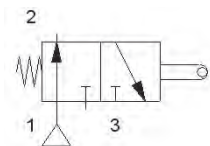
▶ **Microválvulas Tetón** | Micro-valves fin de course | Pin microvalves | Microvalvole di fine corsa

NEU100485

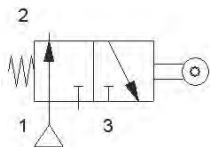
▶ **Microválvulas de Rodillo** | Micro-valves à rouleau | Roller microvalves | Microvalvole a rotella

NEU100490

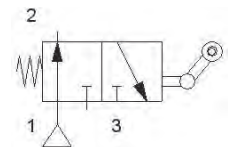

NEU100495

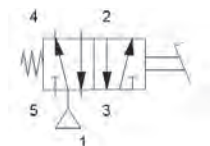
▶ **Pedales** | Pédales | Foot pedal | Pedali

PC 1/4 B

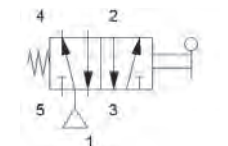

PC 1/4 M

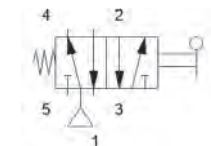

PS 1/4



**Depósitos y Filtros**  
Tanks and Filters



**Electroválvulas**  
Directional Valves



**Bombas**  
Pumps



**Empuñaduras y Selectoras**  
Joysticks and Directional Valves



**Minicentrales**  
Mini-stations



**Acumuladores y Presostatos**  
Pressure and Vacuum Switches



**Válvulas**  
Valves



**Motores Hidráulicos Lentos**  
Hydraulic Motors

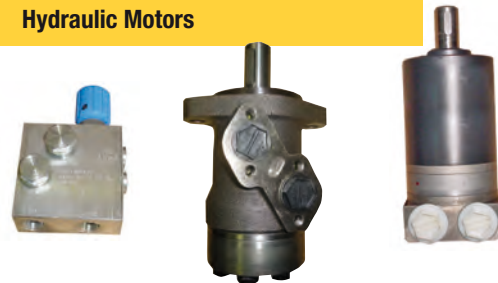

**Distribuidores**  
Directional Control Valves



**Cilindros**  
Cylinders



**Servicio Hidráulico / Hydraulic Service**

# Cilindros neumáticos

Vérins pneumatiques

Cylinders

Cilindri

# 5

Cilindros neumáticos y accesorios ISO 6431	383
Vérins pneumatiques et accessoires ISO 6431   Pneumatic cylinders and accessories ISO 6431   Cilindri pneumatici e accessori ISO 6431	
Microcilindros neumáticos y accesorios ISO 6432	384
Micro-vérins pneumatiques et accessoires ISO 6432   Pneumatic micro-cylinders and accessories ISO 6432   Microcilindri pneumatici e accessori ISO 6431	

**Medidas de los cilindros ISO 6431 | Dimensions des vérins ISO 6431 | Cylinders ISO 6431 dimensions | Quote dei cilindri ISO 6431**

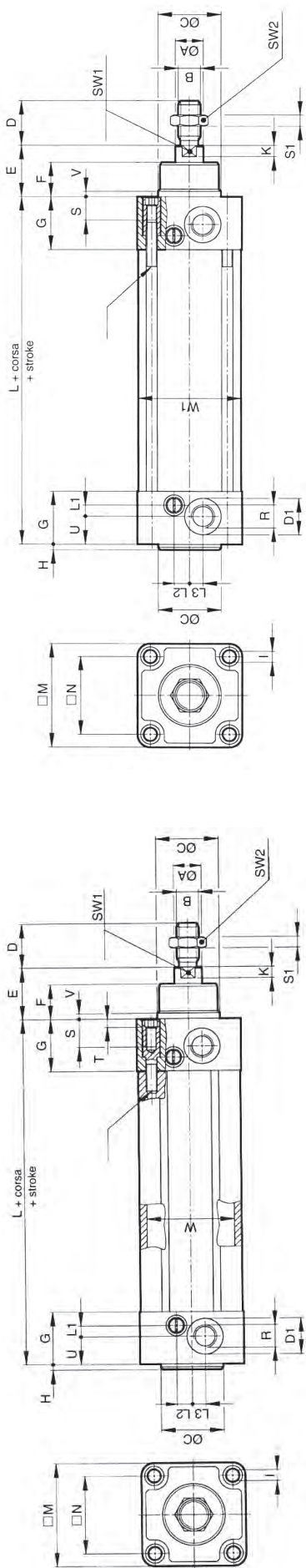

**Hasta Ø int. 125 mm | Jusqu'à Ø int. 125 mm**  
 Until Ø int. 125 mm | Fino Ø int. 125 mm

**A partir de Ø int. 160 mm | A partir du Ø int. 160 mm**  
 From Ø int. 160 mm | A partire da Ø int 160 mm

REF.	Ø Int	A f7	B e11	C	D	E	F	G	H	I	K	L	M	N	P	R	S	T	U	V	W	W1	D1	L1	L2	L3	SW1	SW2	S1
CNM032...	32	12	M 10 x 1,25	30	22	26	16	33	4	M 6	6	94±0,4	47	32,5±0,5	M 6	G 1/8	16	5	14	4	36	38	15	11	4,5	5	10	17	5
CNM040...	40	16	M 12 x 1,25	35	24	30	20	33,5	4	M 6	6,5	105±0,7	52	38±0,5	M 6	G 1/4	16	5	15	4	45	45	19	10	7	6	13	19	6
CNM050...	50	20	M 16 x 1,5	40	32	37	25	34	4	M 8	8	106±0,7	65	46,5±0,6	M 8	G 1/4	16	6	15	4	55	55	19	10	7	6	16	24	8
CNM063...	63	20	M 16 x 1,5	45	32	37	25	38	4	M 8	8	121±0,8	75	56,5±0,7	M 8	G 3/8	16	6	20	4	68	68	26	8	12,5	9,5	16	24	8
CNM080...	80	25	M 20 x 1,5	45	40	46	30	41,5	4	M 10	10	128±0,8	95	72±0,7	M 10	G 3/8	16	6	20	4	86	86	26	8	13,5	9,5	21	30	10
CNM100...	100	25	M 20 x 1,5	55	40	51	35	41,5	4	M 10	10	138±1	115	89±0,7	M 10	G 1/2	16	6	25	4	106	107	30	6	17	12	21	30	10
CNM125...	125	32	M 27 x 2	60	54	65	40	45	5	M 12	13	160±1	140	110±1,1	M 12	G 1/2	20	8	30	5	132	132	30	3	17	12	27	41	13,5
CNM160...	160	40	M 36 x 2	65	72	80	50	47,5	8	M 16	16	180±1,1	180	140±1,1	M 16	G 3/4	21	-	27,5	50	170	170	38	4,5	20	15	36	55	18
CNM200...	200	40	M 36 x 2	75	72	95	65	47,5	8	M 16	16	180±1,6	220	175±1,1	M 16	G 3/4	21	-	27,5	25	210	210	38	4,5	20	15	36	55	18
CNM250...	250	50	M 42x 2	90	84	105	75	55	8	M 20	20	200±1,6	270	220±1,5	M 20	G 1	30	-	31	25	262	262	40	-	37	-	46	65	21
CNM320...	320	63	M 48 x 2	110	96	120	90	57	10	M 24	24	220±1,6	345	270±1,5	M 24	G 1	30	-	31	17	336	336	40	-	37	-	55	75	24

# Microcilindros doble efecto magnéticos ISO 6432

Micro-vérins D.E. magnétiques ISO 6432 | Micro-cylinders double acting ISO 6432 | Microcilindri penumatici ISO 6432

## Medidas de los microcilindros ISO 6432 | Dimensions des Micro-Vérins ISO 6432 | Mycro-Cylinders Dimensions Quote dei microcilindri ISO 6434

Referencia Référence Part No. Codice	Ø int.	A Ø	B	C	D	E	F	G	H Ø	L	M	N	P	Q	R	S	T	CH 1	CH 2
MCDM12...	12	6	M6	16	22	75	9	12	6	17	M16x1,5	20	27,5	35,5	M5	87	8	5	24
MCDM16...	16	6	M6	16	22	82	9	12	6	17	M16x1,5	20	28	42	M5	93,5	8	5	24
MCDM20...	20	8	M8	20	24	95	12	16	8	19	M22x1,5	30	31	49	Gas 1/8"	108	10	7	32
MCDM25...	25	10	M10x1,25	22	28	104	12	16	8	22	M22x1,5	30	35	54	Gas 1/8"	120	10	9	32

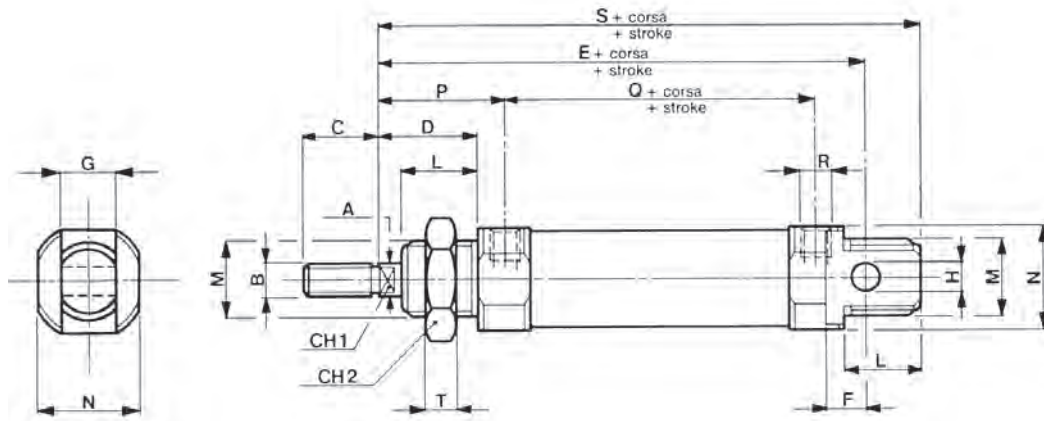

## Accesorios para cilindros ISO 6431 y microcilindros ISO 6432

Accessoires pour vérin ISO 6431 et micro-vérin ISO 6432 | Accessories for ISO 6431 cylinders and ISO 6432 microcylinders  
 Accessori per cilindri ISO 6431 e microcilindri ISO 6432

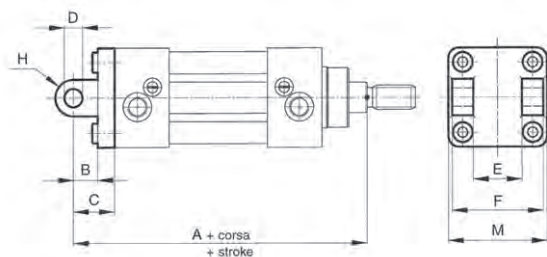

### Charnela Hembra para Cilindro ISO 6431 | Articulation Femelle pour Vérin ISO 6431 | Female Pivot in Steel Cerniera femmina per cilindro ISO 6431

Ref.	A	B	C	D	E	F	H	M	Tornillo
CHCN032	142	13	22	10	26	45	10	45	M6x18
CHCN040	160	16	25	12	28	52	12	52	M6x18
CHCN050	170	16	27	12	32	60	12	65	M8x20
CHCN063	190	21	32	16	40	70	16	75	M8x20
CHCN080	210	22	36	16	50	90	16	95	M10x20
CHCN100	230	27	41	20	60	110	20	115	M10x20
CHCN125	275	30	50	25	70	130	25	140	M12x30
CHCN160	315	35	55	30	90	170	30	180	M16x30
CHCN200	335	35	60	30	90	170	30	220	M16x30
CHCN250	375	45	70	40	110	200	40	270	M20x30
CHCN320	420	50	80	45	120	220	45	350	M24x40

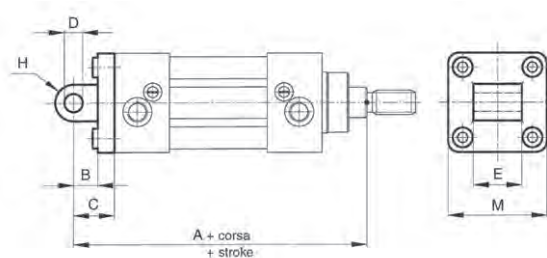

### Charnela Macho para Cilindro ISO 6431 | Articulation Mâle pour Vérin ISO 6431 | Male Pivot in Steel Cerniera maschio per cilindro ISO 6431

Ref.	A	B	C	D	E	H	M	Tornillo
CMCN032	142	13	22	10	26	10	45	M6x18
CMCN040	160	16	25	12	28	12	52	M6x18
CMCN050	170	16	27	12	32	-0,2	65	M8x20
CMCN063	190	21	32	16	40	-0,6	75	M8x20
CMCN080	210	22	36	16	50	16	95	M10x20
CMCN100	230	27	41	20	60	20	115	M10x20
CMCN125	275	30	50	25	70	25	140	M12x30
CMCN160	315	35	55	30	90	-0,5	180	M16x30
CMCN200	335	35	60	30	90	-1,2	220	M16x30
CMCN250	375	45	70	40	110	40	270	M20x30
CMCN320	420	50	80	45	120	45	350	M24x40

## Accesorios para cilindros ISO 6431 y microcilindros ISO 6432

Accessoires pour vérin ISO 6431 et micro-vérin ISO 6432 | Accessories for ISO 6431 cylinders and ISO 6432 microcylinders  
Accessori per cilindri ISO 6431 e microcilindri ISO 6432

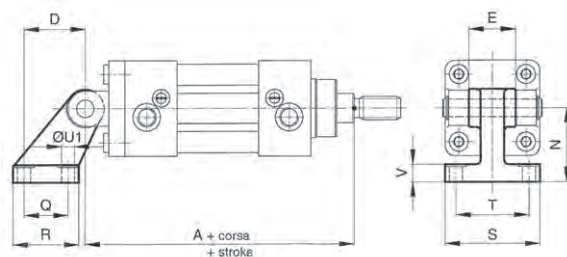

### Contra Charnela para Cilindro ISO 6431 | Contre-Chape pour Vérin ISO 6431 | Right Angles Joint in Steel Contro cerniera per cilindro ISO 6431

Ref.	A	E	N	P	Q	R	S	T	U1	V
CCCN032	142	26	32	21	18	31	51	38	6,5	8
CCCN040	160	28	36	24	22	35	54	41	6,5	10
CCCN050	170	32	45	33	30	45	65	50	9	12
CCCN063	190	40	50	37	35	50	67	52	9	12
CCCN080	210	50	63	47	40	60	86	66	11	14
CCCN100	230	60	71	55	50	70	96	76	11	15
CCCN125	275	70	90	70	60	90	124	94	14	20
CCCN160	315	90	115	97	88	126	156	118	14	25
CCCN200	335	90	135	105	90	130	162	122	18	30
CCCN250	375	110	165	128	110	160	200	150	22	35
CCCN320	420	120	200	150	122	186	234	170	26	40

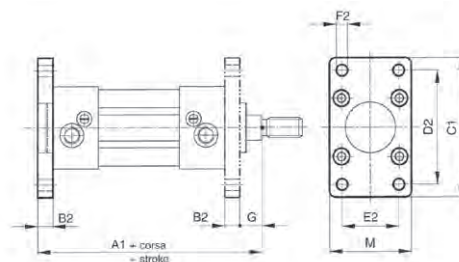

### Brida para Cilindro ISO 6431 | Flasque pour Vérin ISO 6431 | Front or Rear Flange in Zinc-Plated Steel | Flangia per cilindro ISO 6431

Ref.	A1	B2	C1	D2	E2	F2	G	M	Tornillo
BCN032	130	10	80	64	32	7	16	45	M6x18
BCN040	145	10	90	72	36	9	20	52	M6x18
BCN050	155	12	110	90	45	9	25	65	M8x20
BCN063	170	12	120	100	50	9	25	75	M8x20
BCN080	190	16	150	126	63	12	30	95	M10x20
BCN100	205	16	170	150	75	14	35	115	M10x20
BCN125	245	20	205	180	90	16	45	140	M12x30
BCN160	280	20	260	230	115	18	60	180	M16x30
BCN200	300	25	310	270	135	22	70	220	M16x30
BCN250	330	25	390	330	165	26	80	270	M20x30
BCN320	370	30	460	400	200	33	90	350	M24x40

## Accesorios para cilindros ISO 6431 y microcilindros ISO 6432

Accessoires pour vérin ISO 6431 et micro-vérin ISO 6432 | Accessories for ISO 6431 cylinders and ISO 6432 microcylinders  
 Accessori per cilindri ISO 6431 e microcilindri ISO 6432

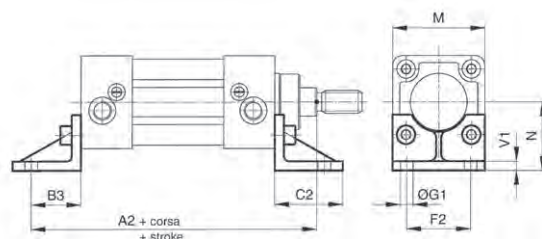

### Pata para Cilindro ISO 6431 | Pied pour Vérin ISO 6431 | Foot Mounting in Zinc-Plated Steel | Piede per cilindro ISO 6431

Ref.	A2	B3	C2	E2	G1	M	N	V1	Tornillo
PCN032	144	24	35	32	7	45	32	3,5	M6x18
PCN040	163	28	36	36	9	52	36	3,5	M6x18
PCN050	175	32	45	45	9	65	45	3,5	M8x20
PCN063	190	32	45	50	9	75	50	4,5	M8x20
PCN080	215	41	55	63	12	95	63	5	M10x25
PCN100	230	41	56	75	14	115	71	5	M10x25
PCN125	270	45	68	90	16	140	90	9	M12x35
PCN160	320	60	80	115	18	180	115	12	M16x30
PCN200	345	70	85	135	22	220	135	12	M16x30
PCN250	380	75	100	165	26	270	165	20	M20x40
PCN320	425	85	120	200	35	350	200	23	M24x45

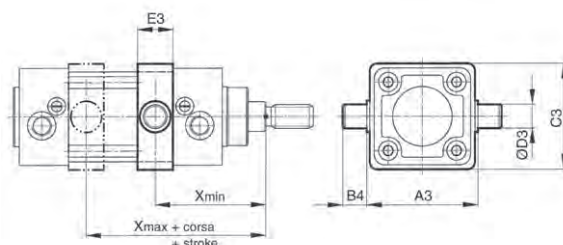

### Charnela intermedia para Cilindro ISO 6431 | Tournillon Central pour Vérin ISO 6431 | Intermediate Pivot Cerniera intermedia per cilindro ISO 6431

Ref.	A3	B4	C3	D3	E3	X mín.	X máx.
CICN032	50	12	57	12	15	67	79
CICN040	63	16	59	16	20	74	91
CICN050	75	16	71	16	20	81	99
CICN063	90	20	86	20	25	88	107
CICN080	110	20	106	20	25	100	120
CICN100	132	25	128	25	30	108	132
CICN125	160	25	155	25	32	126	164
CICN160	200	32	190	32	40	148	193
CICN200	250	32	240	32	40	208	163
CICN250	320	40	300	40	50	185	225
CICN320	400	50	380	50	60	207	253



## Accesorios para cilindros ISO 6431 y microcilindros ISO 6432

Accessoires pour vérin ISO 6431 et micro-vérin ISO 6432 | Accessories for ISO 6431 cylinders and ISO 6432 microcylinders  
Accessori per cilindri ISO 6431 e microcilindri ISO 6432

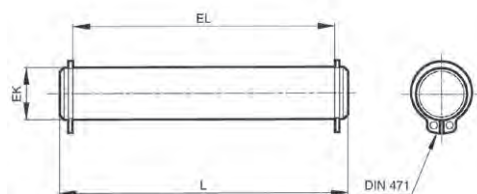

### Bulón Charnela para Cilindro ISO 6431 | Bulon d'articulation pour Vérin ISO 6431 | Pin for Pivot | Perno per cilindro ISO 6431

Ref.	EK	EL	L
BUCN032	10	46	52
BUCN040	12	53	59
BUCN050	12	61	67
BUCN063	16	71	77
BUCN080	16	91	97
BUCN100	20	111	118
BUCN125	25	132	138
BUCN160	30	172	180
BUCN200	30	172	180
BUCN250	40	202	210
BUCN320	45	223	235

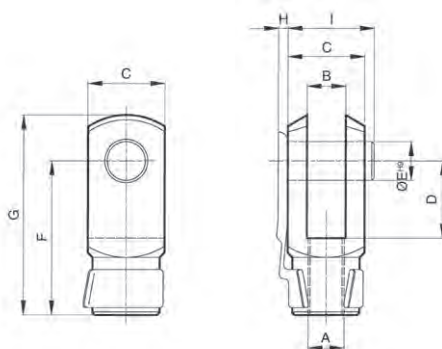

### Horquilla para Cilindro ISO 6431 | Chape de Tige pour Vérin ISO 6431 | Female Rod Clevis | Forcella per cilindro ISO 6431

Ref.	A	B	C	D	E	F	H	H	I
HCN032	M10x1,25	10	20	20	10	40	52	3	23
HCN040	M12x1,25	12	24	24	12	48	62	4	28
HCN050	M16x1,5	16	32	32	16	64	83	4	36
HCN063	M16x1,5	16	32	32	16	64	83	4	36
HCN080	M20x1,5	20	40	40	20	80	105	4	44
HCN100	M20x1,5	20	40	40	20	80	105	4	44
HCN125	M27x2	30	55	54	30	110	148	-	65
HCN160	M36x2	35	70	72	35	144	188	-	84
HCN200	M36x2	35	70	72	35	144	188	-	84
HCN250	M42x2	40	85	84	40	168	232	-	96
HCN320	M48x2	50	90	96	50	192	265	-	102

## Accesorios para cilindros ISO 6431 y microcilindros ISO 6432

Accessoires pour vérin ISO 6431 et micro-vérin ISO 6432 | Accessories for ISO 6431 cylinders and ISO 6432 microcylinders  
 Accessori per cilindri ISO 6431 e microcilindri ISO 6432

Pipe

Fittings

Quick release  
couplings

Industrial elements

Cylinders

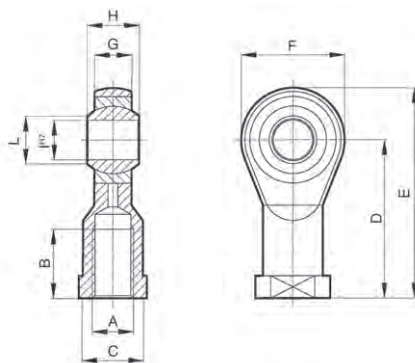

### Rótula para Cilindro ISO 6431 | Rotule pour Vérin ISO 6431 | Oscillating Eye | Snodo per cilindro ISO 6431

Ref.	A	B	C	D	E	F	G	H	I	L
RCN032	M10x1,25	20	17	43	57	28	10,5	14	10	12,9
RCN040	M12x1,25	22	19	50	66	32	12	16	12	15,4
RCN050	M16x1,5	28	22	64	85	42	15	21	16	19,3
RCN063	M16x1,5	28	22	64	85	42	15	21	16	19,3
RCN080	M20x1,5	33	30	77	102	50	18	25	20	24,3
RCN100	M20x1,5	33	30	77	102	50	18	25	20	24,3
RCN125	M27x2	51	41	110	145	70	25	37	30	34,8
RCN160	M36x2	56	50	125	165	80	28	43	35	37,7
RCN200	M36x2	56	50	125	165	80	28	43	35	37,7
RCN250	M42x2	60	55	142	187	90	33	49	40	45,2
RCN320	M48x2	65	65	160	218	116	45	60	50	58

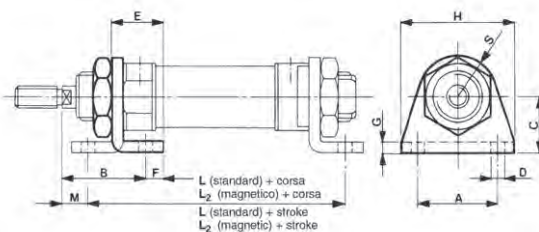

### Pata para Microcilindro ISO 6432 | Pied pour Micro-Vérin ISO 6432 | Foot Mounting | Piede per microcilindro ISO 6432

Ref.	A	B	C	Ø D	E	F	G	H	L	M	S
PMCN12	32	32	20	5,5	19	7	2	46	72	10	13
PMCN16	32	32	20	5,5	19	7	2	46	78,5	10	13
PMCN20	40	36	25	6,6	21,5	7	2,5	54	94	9,5	18
PMCN25	40	40	25	6,6	21,5	7	2,5	54	99	13,5	18

## Accesorios para cilindros ISO 6431 y microcilindros ISO 6432

Accessoires pour vérin ISO 6431 et micro-vérin ISO 6432 | Accessories for ISO 6431 cylinders and ISO 6432 microcylinders  
Accessori per cilindri ISO 6431 e microcilindri ISO 6432

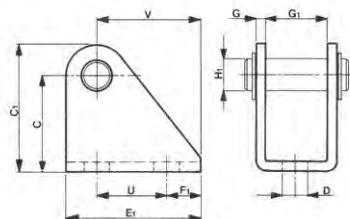

### Charnelas para Microcilindro ISO 6432 | Articulation pour Micro-Vérin ISO 6432 | Rear Pivot Mounting

Cerniera per microcilindro ISO 6432

Ref.	C	C1	Ø D	E1	F1	G	G1	Ø H1	U	V
CMCN12	20	27	5,5	33	7,5	2	12	6	15	26
CMCN16	20	27	5,5	33	7,5	2	12	6	15	26
CMCN20	25	33	6,6	38	9	2,5	16	8	18	30
CMCN25	25	33	6,6	38	9	2,5	16	8	18	30

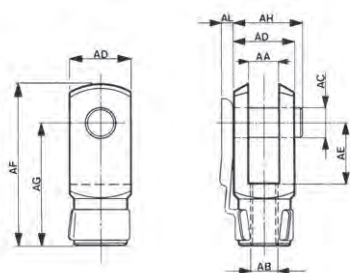

### Horquilla para Microcilindro ISO 6432 | Chape de Tige pour Micro-Vérin ISO 6432 | Rod Clevis | Forcella per microcilindro ISO 6432

Ref.	AA	AB	Ø AC	AD	AE	AF	AG	AH	AL
HMCN12	6	M6	6	12	12	31	24	14	2
HMCN16	6	M6	6	12	12	31	24	14	2
HMCN20	8	M8	8	16	16	42	32	19	3
HMCN25	10	M10	10	20	20	52	40	23	3

## Accesorios para cilindros ISO 6431 y microcilindros ISO 6432

Accessoires pour vérin ISO 6431 et micro-vérin ISO 6432 | Accessories for ISO 6431 cylinders and ISO 6432 microcylinders  
 Accessori per cilindri ISO 6431 e microcilindri ISO 6432

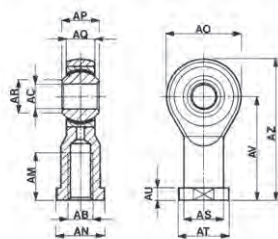

### Rótula para Microcilindro ISO 6432 | Rotule pour Micro-Vérin ISO 6432 | Oscillating Eye | Snodo per microcilindro ISO 6432

Ref.	AB	Ø AC	AM	AN	O	AP	AQ	Ø AR	AS	Ø AT	AU	AV	AZ
RMCN12	M6	6	12	11	20	9	6,8	9	10	13	5	30	40
RMCN16	M6	6	12	11	20	9	6,8	9	10	13	5	30	40
RMCN20	M8	8	16	14	24	12	9	10,5	12,5	16	5	36	48
RMCN25	M10	10	20	17	28	14	10,5	13	15	19	6,5	43	57

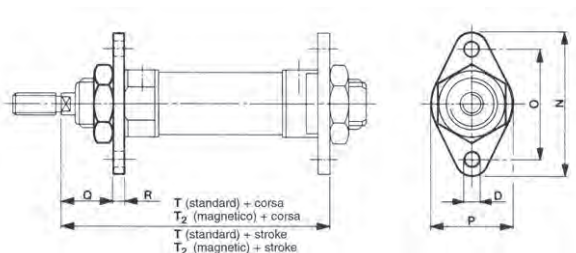

### Brida para Microcilindro ISO 6432 | Flaque pour Micro-Vérin ISO 6432 | Flange Mounting | Flangia per microcilindro ISO 6432

Ref.	Ø D	N	O	P	Q	R	T
BMCN12	5,5	54	40	26	18	4	74
BMCN16	5,5	54	40	26	18	4	80,5
BMCN20	6,6	64	50	36	19	5	94
BMCN25	6,6	64	50	36	23	5	103

## Cilindros neumáticos y accesorios ISO 6431

Vérins pneumatiques et accessoires ISO 6431 | Pneumatic cylinders and accessories ISO 6431 | Cilindri pneumatici e accessori ISO 6431

### Cilindros d.e. magnéticos ISO 6431 | Vérins pneumatiques d.e. magnétiques-ISO 6431 | Pneumatic cylinders ISO 6431 | Cilindro D.E. magnetico ISO 6431

385



CNM0320



CNM0400



CNM0500



CNM0630



CNM0800



CNM1000



CNM1250



CNM1600



CNM2000

### Accesorios para cilindro neumático | Accessoires pour vérins ISO 6431 | Pneumatic accessories ISO 6431 | Accessori per cilindro ISO 6431

387



CHCN



CMCN



CCCN



BCN



PCN



CIGN



BUCN



HCN



RCN

## Microcilindros neumáticos y accesorios ISO 6432

Micro-vérins pneumatiques et accessoires ISO 6432 | Pneumatic micro-cylinders and accessories ISO 6432 | Microcilindri pneumatici e accessori ISO 6431

Pipe

### ▶ **Microcilindros d.e. magnéticos ISO 6432** | Micro-vérins d.e. magnétiques ISO 6432 | Micro-cylinders double acting ISO 6432 | Microcilindri d.e.magnetico ISO 6432 389



MCDM12



MCDM16



MCDM20



MCDM25

Fittings

### ▶ **Microcilindros s.e. magnéticos ISO 6432** | Micro-vérins s.e. magnétiques ISO 6432 | Micro-cylinders single acting ISO 6432 | Microcilindri s.e magnetico ISO 6432 389



MCSM

Quick release couplings

### ▶ **Accesorios para microcilindro** | Accessoires pour micro-vérins | Micro-cylinders accessories | Accessori per microcilindri 390



PMCN



CMCN



HMCN



RMCN



BMCN

Industrial elements

Cylinders

## Cilindros neumáticos y accesorios ISO 6431

Vérins pneumatiques et accessoires ISO 6431  
Pneumatic cylinders and accessories ISO 6431  
Cilindri pneumatici e accessori ISO 6431

### Cilindros d.e. magnéticos ISO 6431 Ø32



Vérins pneumatiques d.e. magnétiques-ISO 6431 Ø32  
Pneumatic cylinders ISO 6431 Ø32  
Cilindri d.e. magnetico ISO 6431 Ø32

CARRERA (mm) STROKE (mm)	REFERENCIA PART N°	€
25	CNM0320025	114,63
50	CNM0320050	117,73
75	CNM0320075	62,69
80	CNM0320080	121,38
100	CNM0320100	62,69
125	CNM0320125	127,64
150	CNM0320150	69,99
160	CNM0320160	132,10
200	CNM0320200	77,22
250	CNM0320250	84,51
300	CNM0320300	91,81
320	CNM0320320	151,35
350	CNM0320350	155,35
400	CNM0320400	162,00
450	CNM0320450	168,65
500	CNM0320500	175,27

### Cilindros d.e. magnéticos ISO 6431 Ø50



Vérins pneumatiques d.e. magnétiques-ISO 6431 Ø50  
Pneumatic cylinders ISO 6431 Ø50  
Cilindri d.e. magnetico ISO 6431 Ø50

CARRERA (mm) STROKE (mm)	REFERENCIA PART N°	€
25	CNM0500025	155,56
50	CNM0500050	160,61
75	CNM0500075	99,25
80	CNM0500080	166,66
100	CNM0500100	99,25
125	CNM0500125	175,75
150	CNM0500150	110,79
160	CNM0500160	182,78
200	CNM0500200	122,41
250	CNM0500250	136,44
300	CNM0500300	148,27
320	CNM0500320	212,18
350	CNM0500350	218,16
400	CNM0500400	228,01
450	CNM0500450	280,37
500	CNM0500500	291,53

### Cilindros d.e. magnéticos ISO 6431 Ø40



Vérins pneumatiques d.e. magnétiques-ISO 6431 Ø40  
Pneumatic cylinders ISO 6431 Ø40  
Cilindri d.e. magnetico ISO 6431 Ø40

CARRERA (mm) STROKE (mm)	REFERENCIA PART N°	€
25	CNM0400025	130,59
50	CNM0400050	134,42
75	CNM0400075	72,33
80	CNM0400080	139,01
100	CNM0400100	72,33
125	CNM0400125	145,98
150	CNM0400150	81,68
160	CNM0400160	151,28
200	CNM0400200	91,03
250	CNM0400250	100,38
300	CNM0400300	109,73
320	CNM0400320	175,92
350	CNM0400350	180,39
400	CNM0400400	188,10
450	CNM0400450	195,80
500	CNM0400500	203,54

### Cilindros d.e. magnéticos ISO 6431 Ø63



Vérins pneumatiques d.e. magnétiques-ISO 6431 Ø63  
Pneumatic cylinders ISO 6431 Ø63  
Cilindri d.e. magnetico ISO 6431 Ø63

CARRERA (mm) STROKE (mm)	REFERENCIA PART N°	€
25	CNM0630025	185,05
50	CNM0630050	190,37
75	CNM0630075	123,26
80	CNM0630080	196,77
100	CNM0630100	123,26
125	CNM0630125	206,31
150	CNM0630150	139,20
160	CNM0630160	213,77
200	CNM0630200	155,14
250	CNM0630250	171,08
300	CNM0630300	187,02
320	CNM0630320	246,35
350	CNM0630350	252,97
400	CNM0630400	263,61
450	CNM0630450	274,28
500	CNM0630500	284,90

## Cilindros neumáticos y accesorios ISO 6431

Vérins pneumatiques et accessoires ISO 6431  
Pneumatic cylinders and accessories ISO 6431  
Cilindri pneumatici e accessori ISO 6431

Pipe

### Cilindros d.e. magnéticos ISO 6431 Ø80



Vérins pneumatiques d.e. magnétiques-ISO 6431 Ø80  
Pneumatic cylinders ISO 6431 Ø80  
Cilindri d.e. magnetico ISO 6431 Ø83

CARRERA (mm) STROKE (mm)	REFERENCIA PART N°	€
25	CNM0800025	237,32
50	CNM0800050	244,75
75	CNM0800075	165,41
80	CNM0800080	253,67
100	CNM0800100	165,41
125	CNM0800125	268,55
150	CNM0800150	186,81
160	CNM0800160	278,92
200	CNM0800200	208,13
250	CNM0800250	229,52
300	CNM0800300	250,99
320	CNM0800320	326,61
350	CNM0800350	335,97
400	CNM0800400	350,96
450	CNM0800450	366,01
500	CNM0800500	381,04

Fittings

Quick release  
couplings

Industrial elements

Cylinders

### Cilindros d.e. magnéticos ISO 6431 Ø125



Vérins pneumatiques d.e. magnétiques-ISO 6431 Ø125  
Pneumatic cylinders ISO 6431 Ø125  
Cilindri d.e. magnetico ISO 6431 Ø125

CARRERA (mm) STROKE (mm)	REFERENCIA PART N°	€
25	CNM1250025	452,03
50	CNM1250050	463,04
75	CNM1250075	474,08
80	CNM1250080	476,18
100	CNM1250100	485,39
125	CNM1250125	496,42
150	CNM1250150	507,45
160	CNM1250160	512,10
200	CNM1250200	530,72
250	CNM1250250	554,38
300	CNM1250300	578,07
320	CNM1250320	587,77
350	CNM1250350	601,72
400	CNM1250400	625,37
450	CNM1250450	649,01
500	CNM1250500	672,71

### Cilindros d.e. magnéticos ISO 6431 Ø100



Vérins pneumatiques d.e. magnétiques-ISO 6431 Ø100  
Pneumatic cylinders ISO 6431 Ø100  
Cilindri d.e. magnetico ISO 6431 Ø100

CARRERA (mm) STROKE (mm)	REFERENCIA PART N°	€
25	CNM1000025	284,51
50	CNM1000050	293,40
75	CNM1000075	387,54
80	CNM1000080	391,25
100	CNM1000100	396,50
125	CNM1000125	405,47
150	CNM1000150	414,66
160	CNM1000160	418,37
200	CNM1000200	433,03
250	CNM1000250	450,96
300	CNM1000300	469,33
320	CNM1000320	476,55
350	CNM1000350	487,48
400	CNM1000400	505,42
450	CNM1000450	523,57
500	CNM1000500	541,72

### Cilindros d.e. magnéticos ISO 6431 Ø160



Vérins pneumatiques d.e. magnétiques-ISO 6431 Ø160  
Pneumatic cylinders ISO 6431 Ø160  
Cilindri d.e. magnetico ISO 643 1Ø160

CARRERA (mm) STROKE (mm)	REFERENCIA PART N°	€
25	CNM1600025	930,98
50	CNM1600050	983,92
75	CNM1600075	1.077,97
80	CNM1600080	1.002,82
100	CNM1600100	1.028,98
125	CNM1600125	1.060,98
150	CNM1600150	1.122,59
160	CNM1600160	1.091,03
200	CNM1600200	1.166,11
250	CNM1600250	1.200,88
300	CNM1600300	1.235,66
320	CNM1600320	1.249,65
350	CNM1600350	1.270,43
400	CNM1600400	1.305,20
450	CNM1600450	1.339,98
500	CNM1600500	1.374,75



## Cilindros neumáticos y accesorios ISO 6431

Vérins pneumatiques et accessoires ISO 6431  
Pneumatic cylinders and accessories ISO 6431  
Cilindri pneumatici e accessori ISO 6431

### Cilindros d.e. magnéticos ISO 6431 Ø200



Vérins pneumatiques d.e. magnétiques-ISO 6431 Ø200  
Pneumatic cylinders ISO 6431 Ø200  
Cilindri d.e. magnetico ISO 6431 Ø200

CARRERA (mm) STROKE (mm)	REFERENCIA PART N°	€
25	CNM2000025	1.175,98
50	CNM2000050	1.216,82
75	CNM2000075	1.335,82
80	CNM2000080	1.260,89
100	CNM2000100	1.290,30
125	CNM2000125	1.331,14
150	CNM2000150	1.405,80
160	CNM2000160	1.371,96
200	CNM2000200	1.451,51
250	CNM2000250	1.497,44
300	CNM2000300	1.543,15
320	CNM2000320	1.564,80
350	CNM2000350	1.589,07
400	CNM2000400	1.635,00
450	CNM2000450	1.680,49
500	CNM2000500	1.726,42

### Charnela hembra para cilindro ISO 6431



Articulation femelle pour vérin ISO 6431  
Female pivot in steel  
Cerniera femmina per cilindro ISO 6431

Descripción Description	REFERENCIA PART N°	€
Para cilindro 32mm	CHCN032	7,36
Para cilindro 40mm	CHCN040	8,15
Para cilindro 50 mm	CHCN050	11,76
Para cilindro 63mm	CHCN063	14,10
Para cilindro 80mm	CHCN080	19,91
Para cilindro 100mm	CHCN100	67,14
Para cilindro 125mm	CHCN125	118,74

### Contra charnela para cilindro ISO 6431



Contre-chape pour vérins ISO 6431  
Right angles joint in steel  
Contro cerniera per cilindro ISO 6431

Descripción Description	REFERENCIA PART N°	€
Para cilindro 32mm	CCCN032	10,20
Para cilindro 40mm	CCCN040	12,89
Para cilindro 50mm	CCCN050	17,71
Para cilindro 63mm	CCCN063	22,53
Para cilindro 80mm	CCCN080	33,22
Para cilindro 100mm	CCCN100	96,23
Para cilindro 125mm	CCCN125	129,03
Para cilindro 160mm	CCCN160	663,97
Para cilindro 200mm	CCCN200	756,70

### Charnela macho para cilindro ISO 6431



Articulation mâle pour vérins ISO 6431  
Male pivot in steel  
Cerniera maschio per cilindro ISO 6431

Descripción Description	REFERENCIA PART N°	€
Para cilindro 32mm	CMCN032	21,54
Para cilindro 40mm	CMCN040	25,98
Para cilindro 50mm	CMCN050	26,39
Para cilindro 63mm	CMCN063	32,66
Para cilindro 80mm	CMCN080	41,10
Para cilindro 100mm	CMCN100	58,16
Para cilindro 125mm	CMCN125	103,29

### Brida para cilindro ISO 6431



Flasque pour vérins ISO 6431  
Front or rear flange in zinc-plated steel  
Flangia per cilindro 6431

Descripción Description	REFERENCIA PART N°	€
Para cilindro 32mm	BCN032	12,26
Para cilindro 40mm	BCN040	13,46
Para cilindro 50mm	BCN050	19,62
Para cilindro 63mm	BCN063	23,31
Para cilindro 80mm	BCN080	36,77
Para cilindro 100mm	BCN100	93,82
Para cilindro 125mm	BCN125	229,64
Para cilindro 160mm	BCN160	329,14
Para cilindro 200mm	BCN200	373,10

## Cilindros neumáticos y accesorios ISO 6431

Vérins pneumatiques et accessoires ISO 6431  
Pneumatic cylinders and accessories ISO 6431  
Cilindri pneumatici e accessori ISO 6431

Pipe

### Pata para cilindro ISO 6431



Pied pour vérins ISO 6431

Foot mounting in zinc-plated steel

Piede per cilindro ISO 6431

Descripción Description	REFERENCIA PART N°	€
Para cilindro 32mm	PCN032	4,96
Para cilindro 40mm	PCN040	7,37
Para cilindro 50mm	PCN050	9,78
Para cilindro 63mm	PCN063	14,17
Para cilindro 80mm	PCN080	16,44
Para cilindro 100mm	PCN100	26,06
Para cilindro 125mm	PCN125	122,71
Para cilindro 160mm	PCN160	192,46
Para cilindro 200mm	PCN200	235,98

Fittings

Quick release couplings

### Charnela intermedia para cilindro ISO 6431



Tournillon central pour vérins ISO 6431

Intermediate pivot

Cerniera intermedia per cilindro ISO 6431

Descripción Description	REFERENCIA PART N°	€
Para cilindro 32mm	CICN032	90,54
Para cilindro 40mm	CICN040	98,85
Para cilindro 50mm	CICN050	115,47
Para cilindro 63mm	CICN063	153,75
Para cilindro 80mm	CICN080	175,62
Para cilindro 100mm	CICN100	236,20
Para cilindro 125mm	CICN125	411,16
Para cilindro 160mm	CICN160	509,35
Para cilindro 200mm	CICN200	879,17

Industrial elements

Cylinders

### Bulón charnela para cilindro ISO 6431



Boulon d'articulation pour vérin ISO 6431

Pin for pivot

Permo per cilindro ISO 6431

Descripción Description	REFERENCIA PART N°	€
Para cilindro 32mm	BUCN032	4,81
Para cilindro 40mm	BUCN040	6,56
Para cilindro 50mm	BUCN050	6,56
Para cilindro 63mm	BUCN063	9,19
Para cilindro 80mm	BUCN080	9,84
Para cilindro 100mm	BUCN100	10,94
Para cilindro 125mm	BUCN125	14,22
Para cilindro 160mm	BUCN160	31,71
Para cilindro 200mm	BUCN200	31,71

### Horquilla para cilindro ISO 6431



Chape de tige pour vérins ISO 6431

Female rod clevis

Forcella per cilindro ISO 6431

Descripción Description	REFERENCIA PART N°	€
Para cilindro 32mm	HCN032	6,66
Para cilindro 40mm	HCN040	9,14
Para cilindro 50mm	HCN050	14,95
Para cilindro 63mm	HCN063	14,95
Para cilindro 80mm	HCN080	26,14
Para cilindro 100mm	HCN100	40,02
Para cilindro 125mm	HCN125	108,04

### Rótula para cilindro ISO 6431



Rotule pour vérin ISO 6431

Oscillating eye

Snodo per cilindro ISO 6431

Descripción Description	REFERENCIA PART N°	€
Para cilindro 32mm	RCN032	4,96
Para cilindro 40mm	RCN040	7,37
Para cilindro 50mm	RCN050	9,78
Para cilindro 63mm	RCN063	14,73
Para cilindro 80mm	RCN080	17,14
Para cilindro 100mm	RCN100	122,25
Para cilindro 160mm	RCN160	402,41
Para cilindro 200mm	RCN200	402,41

## Microcilindros neumáticos y accesorios ISO 6432

Micro-vérins pneumatiques et accessoires ISO 6432  
Pneumatic micro-cylinders and accessories ISO 6432  
Microcilindri pneumatici e accessori ISO 6431

### Microcilindros d.e. magnéticos ISO 6432 Ø12



Micro-vérins d.e. magnétiques ISO 6432 Ø12  
Micro-cylinders double acting ISO 6432 Ø12  
Microcilindri D.E. magnetico ISO 6432

CARRERA (mm) STROKE (mm)	REFERENCIA PART N°	€
10	MCDM12010	53,88
20	MCDM12020	58,07
25	MCDM12025	54,78
50	MCDM12050	57,27
75	MCDM12075	65,83
100	MCDM12100	60,56
125	MCDM12125	62,18

### Microcilindros d.e. magnéticos ISO 6432 Ø20



Micro-vérins d.e. magnétiques ISO 6432 Ø20  
Micro-cylinders double acting ISO 6432 Ø20  
Microcilindri D.E. magnetico ISO 6432

CARRERA (mm) STROKE (mm)	REFERENCIA PART N°	€
10	MCDM20010	58,79
25	MCDM20025	60,28
50	MCDM20050	62,60
75	MCDM20075	79,61
100	MCDM20100	68,62
125	MCDM20125	69,59

### Microcilindros d.e. magnéticos ISO 6432 Ø16



Micro-vérins d.e. magnétiques ISO 6432 Ø16  
Micro-cylinders double acting ISO 6432 Ø16  
Microcilindri D.E. magnetico ISO 6432

CARRERA (mm) STROKE (mm)	REFERENCIA PART N°	€
10	MCDM16010	56,60
25	MCDM16025	57,95
50	MCDM16050	60,28
75	MCDM16075	68,23
100	MCDM16100	63,56
125	MCDM16125	64,66

### Microcilindros d.e. magnéticos ISO 6432 Ø25



Micro-vérins d.e. magnétiques ISO 6432 Ø25  
Micro-cylinders double acting ISO 6432 Ø25  
Microcilindri D.E. magnetico ISO 6432

CARRERA (mm) STROKE (mm)	REFERENCIA PART N°	€
10	MCDM25010	65,88
25	MCDM25025	67,14
50	MCDM25050	69,32
75	MCDM25075	87,04
100	MCDM25100	72,90
125	MCDM25125	76,60

### Microcilindros s.e. magnéticos ISO 6432



Micro-vérins s.e. magnétiques ISO 6432  
Micro-cylinders single acting ISO 6432  
Microcilindri s.e. ISO 6432

Ø in	CARRERA (mm) STROKE (mm)	REFERENCIA PART N°	€
12	10	MCSM12010	53,55
12	25	MCSM12025	55,34
12	50	MCSM12050	56,97
16	10	MCSM16010	56,33
16	25	MCSM16025	57,69
16	50	MCSM16050	60,01
20	10	MCSM20010	58,48
20	25	MCSM20025	60,01
20	50	MCSM20050	62,34
25	10	MCSM25010	65,65
25	25	MCSM25025	66,85
25	50	MCSM25050	69,06

## Microcilindros neumáticos y accesorios ISO 6432

Micro-vérins pneumatiques et accessoires ISO 6432  
Pneumatic micro-cylinders and accessories ISO 6432  
Microcilindri pneumatici e accessori ISO 6431

Pipe

Fittings

Quick release couplings

Industrial elements

Cylinders

### Patatas para microcilindro



Pied pour micro-vérins  
Foot mounting  
Piede per microcilindro

Descripción Description	REFERENCIA PART N°	€
Para microcilindro 12mm	<b>PMCN12</b>	<b>4,72</b>
Para microcilindro 16mm	<b>PMCN16</b>	<b>5,25</b>
Para microcilindro 20mm	<b>PMCN20</b>	<b>4,91</b>
Para microcilindro 25mm	<b>PMCN25</b>	<b>6,56</b>

### Rótulas para microcilindro



Rotules pour micro-vérins  
Oscillating clevis  
Snodo per microcilindro

Descripción Description	REFERENCIA PART N°	€
Para microcilindro 12mm	<b>RMCN12</b>	<b>18,59</b>
Para microcilindro 16mm	<b>RMCN16</b>	<b>25,59</b>
Para microcilindro 20mm	<b>RMCN20</b>	<b>19,58</b>
Para microcilindro 25mm	<b>RMCN25</b>	<b>22,02</b>

### Bridas para microcilindro



Flasque pour micro-vérins  
Flange mounting  
Flange per microcilindro

Descripción Description	REFERENCIA PART N°	€
Para microcilindro 12mm	<b>BMCN12</b>	<b>5,03</b>
Para microcilindro 16mm	<b>BMCN16</b>	<b>5,03</b>
Para microcilindro 20mm	<b>BMCN20</b>	<b>8,53</b>
Para microcilindro 25mm	<b>BMCN25</b>	<b>8,53</b>

### Charnelas para microcilindro



Articulation pour micro-vérins  
Rear pivot mounting  
Cerniere per microcilindro

Descripción Description	REFERENCIA PART N°	€
Para microcilindro 12mm	<b>CMCN12</b>	<b>7,17</b>
Para microcilindro 16mm	<b>CMCN16</b>	<b>7,95</b>
Para microcilindro 20mm	<b>CMCN20</b>	<b>7,36</b>
Para microcilindro 25mm	<b>CMCN25</b>	<b>9,84</b>

### Horquillas para microcilindro



Chape de tige pour micro-vérins  
Rod clevis  
Forcella per microcilindro

Descripción Description	REFERENCIA PART N°	€
Para microcilindro 12mm	<b>HMCN12</b>	<b>3,96</b>
Para microcilindro 16mm	<b>HMCN16</b>	<b>4,16</b>
Para microcilindro 20mm	<b>HMCN20</b>	<b>4,15</b>
Para microcilindro 25mm	<b>HMCN25</b>	<b>5,09</b>

## GENERALIDADES

Estas condiciones así como las eventuales condiciones especiales acordadas en el contrato rigen para todas las entregas y todas las prestaciones. Las condiciones de compra del cliente que sean distintas a las aquí establecidas no llegarán a formar parte del contrato al aceptar el pedido. Los contratos se celebran, salvo en el caso de que se haya acordado lo contrario, mediante confirmación escrita del proveedor. En ningún caso, las Condiciones Generales y/o Específicas de Compra del Comprador, anularán o sustituirán estas Condiciones Generales de Venta.

La aceptación de nuestras ofertas implica tácitamente la de todas las condiciones aquí detalladas, salvo las especiales acordadas por escrito, particularmente en la misma Oferta o detalladas en nuestro acuse de recepción de pedido, únicos documentos que nos obligan ante el Cliente.

DICSA se reserva el derecho de propiedad y el derecho de propiedad intelectual de muestras, presupuestos, planos e información en forma material o inmaterial así como en forma electrónica; el acceso de terceros a éstos ha de impedirse.

## OFERTAS Y PEDIDOS

Los precios se entienden, caso de no expresar lo contrario para mercadería situada en nuestro almacén, incluyendo el cargado de ésta, pero sin incluir el embalaje ni el transporte al lugar de recepción, ni impuestos –que serán siempre a cargo del comprador-, así como tampoco la puesta en marcha en el emplazamiento. Todas las operaciones de transporte, seguro, manutención y entrega son a cuenta y riesgo del Comprador.

Las ofertas incluyen solamente los materiales y artículos en ellas especificados disponibles en stock salvo agotamiento y por el plazo de validez determinado en las mismas.

Los estudios u ofertas de material están basados en los precios vigentes en la fecha de su realización, y si, debido a alteraciones en el coste de los materiales, modificación de aranceles o a cualquier otra causa, el nivel de precios fuese revisado, los precios que se aplicarían serían aquellos que rijan en la fecha del suministro, a menos que la oferta sea aceptada dentro del plazo de validez que en la misma se fije.

Los precios no incluyen, excepto notificación expresa, el montaje y la puesta en marcha de los materiales suministrados, los fluidos recomendados por los servicios técnicos de los fabricantes, los contenedores tanto rígidos como elásticos de los materiales, así como el estudio de implantación de los distintos materiales.

DICSA podrá variar el precio, como consecuencia de cualquier ley que afecte a materiales, salarios o a las horas de trabajo y también a posibles cambios en la paridad de la moneda, en elementos de importación.

Los pedidos no serán tomados en consideración a menos que vengan acompañados de la cantidad a cuenta prevista en nuestra Oferta, si así se ha establecido.

La aceptación de la Oferta supondrá igualmente la aceptación sin reservas de estas Condiciones Generales de Venta.

## ESTUDIOS, PLANOS Y DISEÑOS

La información relacionada con la oferta, tal como planos, diseños, dibujos catálogos y/u otra documentación técnica, es solamente informativa y tienen como objeto dar una imagen general de los materiales en ellos descritos, no formando parte del contrato a menos que haya habido algún acuerdo por escrito. DICSA no aceptará ningún tipo de responsabilidad por la inexactitud u omisión de dicha documentación.

El Cliente deberá hacer siempre un estudio previo de compatibilidad y de montaje de los elementos en su instalación y será el único responsable de la puesta en conformidad de dicha instalación con las distintas reglamentaciones vigentes.

En presupuestos, planos, esquemas y otras informaciones técnicas, mantendremos reservado el derecho de propiedad y de realización, no permitiendo que estos sean facilitados a terceros sin nuestro previo consentimiento escrito.

## TRABAJOS IN SITU

Los presupuestos de los trabajos realizados en el lugar de la obra del cliente son considerados orientativos, debido a las características particulares y especiales que pueden representar, no pudiendo dar lugar, excepto acuerdo definitivo entre las partes, en precios definitivos.

## REPARACIÓN

Los trabajos de reparación no se empezarán hasta la aceptación escrita, por parte del Cliente, del presupuesto y de las condiciones que se establezcan.

En el supuesto de que el presupuesto no sea aceptado por el Cliente en el plazo de un mes, los gastos derivados del desmontaje, almacenaje, peritaje y portes correrán a cargo del Cliente. Si el Cliente solicita la reparación antes de aceptar el presupuesto, los trabajos se llevarán a cabo lo antes posible y, por su parte, el Cliente deberá aceptar el coste final de la reparación.

## GENERAL TERMS

These conditions, together with the eventual specific conditions accorded in the contract, apply to all deliveries and all services. The purchase conditions of the customer, if different from those herein established, will not be part of the contract on having accepted the order.

The contracts are concluded, unless otherwise agreed upon by the Parties in writing, by means of written confirmation of the supplier. The General Conditions and / or Specific Conditions of Purchase of the Buyer, cannot, in no case, cancel or replace these General Conditions of Sale.

The acceptance of our offers implies tacitly the acceptance of all the conditions detailed herein, except the special ones that have the agreement in writing, particularly in the same offer or detailed in our accuse of receipt of order, the only documents that oblige us before the Customer. DICSA has the right of property and the right of intellectual property of samples, budgets, technical documentation and information in material or immaterial form as well as in electronic form; the access of third parties to these documents must be forbidden.

## OFFERS AND ORDERS

Except in case of having expressed the opposite, the prices include the merchandise placed in our store, including its loading, but without including the packing nor the transport to the place of receipt, nor taxes, nor the getting started - these will always be at the expense of the customer. All the operations of transport, insurance, handling and delivery are on the account and risk of the Customer.

The offers include only the materials and products expressed in them, available in stock until end of stock, with the term of validity expressed in the same offers.

The studies or offers of material are based on the prices on the date the offer was made, and if, due to changes in the cost of the materials, modification of duties or to any other reason, the level of prices was checked, the prices that would be applied would be those that apply in the date of the delivery, unless the offer is accepted in the term of validity expressed in it.

The prices do not include, unless specific notification, the assembly and the getting started of the supplied materials, the fluids recommended by the technical services of the suppliers, the containers of the materials, as well as the study of the setting up of the different materials. DICSA may change the price, as a consequence of any law that concerns materials, wages, or the working hours, but also as a consequence of probable changes in the parity of the currency since it concerns the elements of import.

The orders will not be taken in consideration unless they are provided with the specific amount in our account, foreseen in our Offer, if this condition has been pre-established. The acceptance of the Offer will suppose equally the acceptance without reserve of these General Conditions of Sale.

## STUDIES, TECHNICAL DOCUMENTATION

The information related to the offer, as technical documentation, designs, drawings, catalogues and / or any another technical documentation, is only informative and they have as object to give a general image of the materials described in them, they do not form a part of the contract unless written agreement. DICSA will not accept any type of responsibility for inaccuracy or omission of the above mentioned documentation.

The Customer will always have to do a previous study of compatibility and of assembly of the elements in his installation and will be the only responsible for the putting in conformity of the above mentioned installation with the current regulations. In offers, drawings, schemes and other technical information, we reserve ourselves the right of property and of design, not allowing that these should be facilitated to third parties without our previous written assent.

DICSA retains the property of the supplied merchandise until full payment of the agreed price. DICSA also retains the property of the Product's project, which in no circumstances shall be disclosed or sold to third parties.

## THE ASSEMBLIES AT THE LOCATION (PLANT) OF THE CUSTOMER

The offers of the assemblies done for the customer, in his elected location of work, are considered as an estimate (approximate calculation), due to the particular and special characteristics that they can represent, not being able to give place, except final agreement between the parts, to final prices.

## REPAIRMENT

The works of repair will not be begun until written acceptance, on the part of the Customer, of the offer and of the conditions established in it. Supposing that the offer is not accepted by the Customer within one month, the expenses derived from the disassembly, storage, survey and freightage will be chargeable to the Customer. If the Customer requests the repair before accepting the offer, the assemblies will be carried out as soon as possible and, for his part, the Customer will have to accept the final cost of the repair.

In case of delivery of new products in exchange for the repair, if this one was out of guarantee, the Customer will have to accept the payment corresponding

En caso de entregarse productos nuevos a cambio de la reparación, si esta estuviera fuera de garantía el Cliente deberá aceptar el cargo correspondiente a la misma.

Los presupuestos de reparación siempre son orientativos y en ningún caso deben tomarse como precios finales.

#### PLAZOS DE ENTREGA

DICSA se reserva la facultad de rechazar un pedido en función de la disponibilidad de los productos. En este supuesto, lo comunicará al comprador con la mayor brevedad posible.

El plazo de entrega será acordado por las partes contractuales. Los plazos de entrega se calcularán desde la fecha de recepción de la confirmación del pedido, pudiendo DICSA proceder sin interrupción alguna. DICSA no será responsable de las demoras en el suministro de toda o parte de la mercancía en el caso de fuerza mayor, tal como catástrofes naturales, limitaciones legales, huelgas, etc., o cualquier otra causa fuera de nuestro control. En el caso de darse alguna de las razones anteriormente citadas, el periodo de entrega se hará extensible al mismo período de tiempo que dure la causa que haya motivado el retraso. Sin embargo, si el período excediera de seis meses, DICSA podrá cancelar la parte no enviada notificando previamente por escrito al comprador.

Procuramos con el mayor interés, cumplir los plazos de entrega que se indican en nuestras ofertas o en nuestras confirmaciones de pedido, si bien es materialmente imposible responder plenamente de dicho cumplimiento, por depender de otros proveedores y de inesperadas circunstancias totalmente ajenas a nuestro posible control. De ahí que no se aceptarán sanciones por demora en la entrega prevista.

#### DERECHO DE PROPIEDAD

DICSA mantiene la propiedad de la mercancía hasta que el comprador realice el pago por completo de la misma.

Será responsabilidad del comprador tomar las medidas necesarias para conservar en buen estado la mercancía hasta que haya sido pagada, debiendo asegurarse a DICSA el cobro de la misma en caso de haber sido vendida a terceras personas por el comprador.

#### RECLAMACIONES. GARANTÍA

No se responderá de ninguna reclamación que no sea efectuada dentro de los 12 meses siguientes a la entrega de la mercancía, ni se aceptarán devoluciones sin autorización previa o pasados 15 días desde la entrega de la mercancía. En cualquier caso, toda devolución deberá ir acompañada de copia de nuestra autorización y, siempre que no sea por causas imputables a DICSA, conllevará un recargo mínimo del 20% sobre el coste del material devuelto, corriendo todos los gastos a cargo del cliente.

En relación con los defectos que aparezcan en los productos suministrados, DICSA aceptará como única responsabilidad u obligación, abonar la pieza o piezas defectuosas siempre que la mercancía haya sido tratada adecuadamente y que los defectos surgidos sean debidos a defectos de material o fabricación.

La garantía comprende la reposición o reparación de los elementos defectuosos a realizar en nuestros talleres.

La garantía se entiende siempre con el material presumiblemente defectuoso depositado en nuestras instalaciones, con los gastos de transporte y riesgo a cargo del comprador.

Los consejos y asesoramiento dados antes y post cierre del contrato, se realizan con la mejor intención y según nuestros máximos conocimientos, no obstante DICSA no asume ninguna clase de responsabilidades a este respecto, ni responderá de los eventuales daños directos o indirectos que indistintamente, por quién, dónde y por qué puedan producirse.

DICSA garantiza exclusivamente sus materiales excluyendo cualquier responsabilidad por los efectos o perjuicios que estos puedan provocar en instalaciones, maquinarias o circuitos. En ningún caso se responsabilizará de los accidentes personales o materiales y pérdidas de producción.

Se excluye de la garantía las averías producidas por mal uso o deficiente instalación, averías provocadas por sometimiento de los equipos a esfuerzos anormales con fines experimentales, de ajuste o prueba. La total responsabilidad de DICSA por los daños causados, independientemente del tipo de acción o teoría de la responsabilidad, no excederá del importe de la obra, instalación o materiales que haya sido objeto de pedido a DICSA. Cualquier importe que supere dicha cantidad y que DICSA se vea obligada a soportar ya sea por decisión judicial, arbitral o similar, será repetida a la compradora hasta lograr indemnidad.

Se encuentran excluidos de esta garantía:

- El uso de instalaciones o servicios, que se aparten de los manuales de instrucción o especificaciones de DICSA
- El uso inadecuado de instalaciones o negligencia del Comprador, sus Ayudantes o Agentes.
- Las partes suministradas por el Comprador.

#### PORTES

La mercancía se entiende siempre depositada en el domicilio de DICSA, incluso en operaciones condicionadas a la entrega en destino y la mercancía siempre viajará por cuenta y riesgo del comprador, siendo a su cargo inclusive

to it. The budgets of repair are always as estimation and should not be considered as final prices.

#### DELIVERY TERMS

DICSA saves itself the right to reject an order depending on the availability of the products. In this supposition, DICSA will communicate it to the Customer as promptly as possible.

The delivery time has to be approved by the contractual parts. The delivery time will be calculated from the date of receipt of the confirmation of the order, when DICSA will be able to proceed without any interruption. DICSA will not be responsible for the delays in the supply of all or in part of the goods in case of major force, such as natural catastrophes, legal limitations, strikes, etc., or any other reason beyond our control. In case of any of the reasons previously mentioned, the period of delivery will be extensible to the same period of time that lasts the reason that has motivated the delay. Nevertheless, if the period exceeds six months, DICSA may cancel the part that couldn't be sent, by previously notifying the Customer in writing.

We do our best to respect the delivery times that are indicated in our offers or in our order confirmations, though it is materially impossible to answer completely for the above mentioned fulfillment, since we depend on other suppliers and on unexpected circumstances totally foreign to our possible control. Won't be accepted any sanctions for the delay in the foreseen delivery.

#### RIGHT OF PROPERTY

DICSA maintains the property of the materials (products) until the Customer makes the payment in full of the merchandise.

The Customer is responsible for taking the necessary actions to preserve in good condition the merchandise until it has been paid, must insure DICSA of the payment of the same one in case of having being sold to third persons by the Customer.

#### CLAIMS. WARRANTY

We won't attend any claim done after the 12 months following the delivery of the merchandise. Returned material will not be allowed without previous authorization or when the time between the purchase and the request for return exceeds 15 days.

In any case, all returned merchandise will have to be accompanied by a copy of our authorization and, providing that it is not for reasons attributable to DICSA, will carry a minimal surcharge of 20 % on the cost of the returned material, all the expenses will be charged to the customer. Concerning the faults that appear in the supplied products, DICSA will only accept as unique responsibility or obligation, the paying of the product or defective products providing that the products (merchandise) have been treated adequately and that the arisen faults are due to faults of material or manufacture.

The warranty includes the replacement or repair of the defective elements in our workshops. The warranty is understood always in relation with the presumably defective material deposited in our warehouse, but the costs of transport and the risk being at the expense of the Customer. The advices given before and post closing of the contract, are made with the best intention and according to our know-how, nevertheless DICSA does not assume any category of responsibilities in this regard, nor will answer of the eventual direct or indirect damages that could take place indistinctly, no matter who, where and why they may take place.

DICSA will not be responsible for any consequence or indirect damages occurred to the Customer, and / or third Parties including but not limited to loss of opportunities, business and incomes.

DICSA guarantees exclusively its own materials, excluding any responsibility for the effects or damages that these could provoke in facilities, equipments or conductions. In no case will take responsibility for accidents related to individuals or materials or for losses in fabrication.

The warranty excludes the breakdowns produced by badly use or deficient installation, breakdowns provoked by overloading of the equipments for experimental purposes, either for adjustment or testing. DICSA's total responsibility for the caused damages, independently of the type of action or theory of the responsibility, will not exceed the amount of the work done, installation or materials that have been object of the order to DICSA.

Any amount that exceeds the above mentioned quantity, and any amount that DICSA will have to support either for judicial, arbitral or similar decision, will be transmitted to the Customer until obtaining indemnity.

Will be excluded from this warranty:

- The use of facilities or services, which are different of those included in the manuals of instruction or in DICSA's specifications
- The inadequate use of facilities or negligence of the Customer, his Assistants or Agents.
- The parts supplied by the Customer

#### FREIGHTAGES

By merchandise we always mean the one deposited in DICSA's warehouse, even in operations conditioned by the delivery at destination and the merchandise will always travel at the account and risk of the Customer, being at his charge, including the additional insurances that could be established and

los seguros adicionales que pudieran establecerse y los permisos especiales a que hubiera lugar.

Según se establece en el artículo 18 del Real Decreto 782/1998 para los envases y embalajes acogidos a la Disposición adicional 1ª de la Ley 11/1997, el responsable de la entrega de los residuos de los embalajes y envases usados, para su correcta gestión ambiental, será el usuario final.

#### ENVÍOS DE EMERGENCIA

Sea cual fuere el medio de transporte utilizado, avión, courier, régimen de equipajes, agencias especiales, mensajeros etc. Independientemente del importe de dicho servicio, el comprador correrá con todos los gastos extra, los de acarreo, de desplazamientos, y de comunicaciones que el servicio haya ocasionado, sin que en ningún caso este valor pueda ser inferior a 60 Euros.

#### PEDIDOS ESPECIALES

Todo pedido de material especial, conllevará el pago anticipado del 50% del importe del pedido, como condición indispensable para su aceptación. Dicho importe quedará siempre a favor de DICSА como indemnización en cualquier caso de anulación por parte del comprador, sin perjuicio de las reclamaciones que por Ley se puedan tener derecho.

#### VENTA MÍNIMA

La facturación mínima será de 50 euros sea cual sea el importe del pedido.

#### PAGOS

Los pagos se realizarán como máximo y salvo acuerdo expreso entre las partes, a 60 días desde la fecha de la factura y previa recepción de los informes positivos de crédito. Si el comprador no efectuare el pago de cualquiera de los suministros a su vencimiento, DICSА está autorizado a suspender los envíos posteriores hasta que se realice dicho pago. Cualquier cargo bancario asociado con el pago de la mercancía, así como los gastos de devolución de efectos en caso de impago, serán por cuenta del comprador.

En caso de demora en el pago y sin perjuicio de otros derechos atribuidos al comprador por la legislación en vigor, el comprador abonará a DICSА un interés de demora del 2% mensual desde la fecha de vencimiento de la factura.

#### COBRO DE LETRAS O RECIBOS DEVUELTOS O APLAZADOS

Serán a cargo del librado:

- Gastos de devolución
- Intereses del 1% mensual desde el día del vencimiento fallido hasta la fecha de cobro definitivo.
- Posible valor del timbre de nuevos documentos.
- Prima de seguro de crédito

#### PAGOS COINCIDENTES EN VACACIONES

Si el cliente no pudiese atender los pagos que coincidiesen con periodos vacacionales, éstos se trasladarán al mismo día del mes anterior. En caso de existir días fijos de pago, el vencimiento se trasladará al día hábil de pago inmediatamente anterior.

#### USO DE SOFTWARE

En la medida en que el volumen de entrega incluye la puesta a disposición de software, el cliente tiene el derecho no exclusivo a usarla incluyendo la documentación adjunta. Se le cede el software para el uso en el objeto de entrega al cual va destinado. No se admite el uso de este software en otro sistema. La modificación, traducción o adaptación de código de objeto a código de origen así como la reproducción de software solamente se admite en la medida legalmente establecida. El cliente se compromete a no retirar las indicaciones del fabricante, especialmente indicaciones del Copyright sin el consentimiento previo de DICSА. Todos los demás derechos sobre el software y la documentación incluyendo las copias, corresponden a DICSА o al proveedor del software. No se admite la concesión de sublicencias.

#### DERECHO APLICABLE Y JURISDICCION

Las relaciones jurídicas entre DICSА y el comprador están sujetas al derecho Español. El tribunal competente será el del domicilio de DICSА. Sin embargo, DICSА podrá optar por interponer las acciones legales correspondientes en el domicilio del comprador.

the special permissions it may need. According to what it is established in the article 18 of the Royal decree 782/1998 concerning wrapping and packaging mentioned in the 1<sup>st</sup> additional Disposition (Regulation) of the Law 11/1997, the person responsible for the delivery of the residues of the packaging and worn packages, for the correct environmental management, will be the final user.

#### EMERGENCY DELIVERIES

No matter the type of the transportation used: by plane, courier, as baggage (luggage), special agencies, messengers etc; independently of the amount of the above mentioned service, the Customer will pay all the extra expenses, those of transportations, of shipping, and of communications that the service has caused; this value may not, under no circumstance, be lower than 60 Euros.

#### SPECIAL ORDERS

Any order (request) of special material, will carry the anticipated payment of 50 % of the amount of the order (request), as an indispensable condition for its acceptance. The above mentioned amount will always be in favor of DICSА as compensation in case of cancellation on the part of the Customer, without prejudice of the claims at which they may have right by Law.

#### MINIMAL SALE

The minimal invoice will be of 50 euros, no matter the amount of the order.

#### PAYMENTS

The payments have to be done, except express written agreement between the parts, in maximum 60 days from the date of the invoice and previous receipt of the positive reports of credit. If the Customer doesn't make the payment in time, for a part of the merchandise supplied, DICSА is authorized to suspend the posterior deliveries until the Customer executes the due payments. Any bank charges associated with the payment of the merchandise, as well as the expenses of return of it in case of non-payment, will be at the expense of the Customer. In case of delay in the payment and without prejudice of other rights attributed to the buyer for the legislation in effect, the Customer will pay to DICSА an interest of monthly delay of 2 % starting from the date when the invoice comes to its term.

#### UNPAID OR POST-PONED INVOICES

Will be at the expense of the Customer:

- The return expenses
- Monthly interests of 1%, from the day when the payment has come to its term and wasn't made, until the date of full payment
- Possible amount (value) of the stamp of the new documents.
- The credit insurance

#### COINCIDENTAL PAYMENTS IN VACATIONS

If the client could not attend to the payments that were coinciding with vacation periods, these will move to the same day of the previous month. In case there are fixed days of payment, the term of the invoice will move to the immediately previous working day of payment.

#### THE SOFTWARE USE

If the delivery includes the putting at the disposal of the Customer software, the Customer has the exclusive right to use it, including the attached documentation. The software is sent for the use in the object of delivery to which it is destined. It is forbidden the use of this software into any other system. The modification, translation or adjustment of the code of object to code of origin as well as the reproduction of software is only admitted into the legally established limits. The Customer promises not to withdraw the indications of the manufacturer, especially the indications of the Copyright, without DICSА's previous assent. All the other rights on the software and the documentation including the copies, they belong to DICSА or to the supplier of the software. The concession of sublicenses is not admitted.

#### GOVERNING LAW AND JURISDICTION

These General Conditions and any agreement between DICSА and the Customer shall be exclusively governed by Spanish laws. The exclusive jurisdiction on any dispute between the DICSА and the Customer shall be the courts of DICSА's domicile. Nevertheless, DICSА has also the right to bring legal action against the Customer before the courts of the place of business and/or residence of the Customer.

Gama de productos. Para más información soliciten nuestros catálogos generales o visiten nuestra página web  
 Gamme de produits. Pour plus d'information, nous vous prions de nous demander nos catalogues généraux ou visiter notre web-site  
 Products range. For any further information, please, ask for our general catalogues or visit our web-site  
 Gamma di Prodotti. Per ulteriori informazioni di ricicidete il nostri cataloghi o visitate la Nostra pagina web

Tarifa General  
 General Price List  
 Tarif Générale  
 2012



**NUEVO**

**DICSA**  
 Conducciones  
 hidráulicas y neumáticas

Connectique hydraulique et pneumatique  
 Hydraulic and pneumatic conducts  
 Conduiture idrauliche e pneumatiche

Tarifa General  
 General Price List  
 Tarif Générale  
 2012



**NUEVO**

**DICSA**  
 Componentes

Components Composants

**AISI 316 L**



Racores inoxidable  
 Raccords en Acier Inox  
 Stainless Steel Fittings  
 Raccordi in Acciao Inossidabile

**DICSA**

Lista de precios 2011  
 Tarif / Price List / Listino Prezzi

[www.dicsaes.com](http://www.dicsaes.com)

**NUEVO**



Planchas, Pavimentos y Alfombras  
 2012

**DICSA**

[www.dicsaes.com](http://www.dicsaes.com)





► **Presidencia |  
Presidency**

Tel. 976 464 100  
Fax 976 464 104  
dicsa@dicsaes.com

► **Dirección |  
Management**

Tel. 976 479 544  
Fax 876 762 027  
management@dicsaes.com

**Atención al cliente | Customer service**

Departamento comercial | Commercial department

Gestión de pedidos | Orders management

► **Nacional | National**

Tel. 976 464 108  
Fax 976 464 113  
comercial@dicsaes.com

► **Internacional |  
International**

Tel. +34 976 464 106  
Fax +34 876 762 032  
export@dicsaes.com

► **Nacional | National**

Tel. 976 464 100  
976 464 101  
976 464 102  
Fax 976 464 105  
pedidos@dicsaes.com

► **Internacional |  
International**

Tel. +34 976 464 100  
+34 976 464 101  
Fax +34 976 464 104  
orders@dicsaes.com

**Otros servicios | Other services**

► **Dpto. Calidad |  
Quality Dpt.**

Tel. 976 479 545  
Fax 876 762 030  
calidad@dicsaes.com

► **Dpto. Informática |  
Computer Dpt.**

Tel. 976 479 555  
Fax 876 762 030  
informatica@dicsaes.com

► **Dpto. Producción |  
Production Dpt.**

Tel. 976 479 543  
Fax 876 762 036  
produccion@dicsaes.com

► **Dpto. Finanzas |  
Accounting Dpt.**

Tel. 976 479 542  
Fax 876 762 029  
finanzas@dicsaes.com

► **Dpto. Compras |  
Purchasing Dpt.**

Tel. 976 464 107  
Fax 876 762 031  
compras@dicsaes.com

► **Oficina de almacén |  
Warehouse Dpt.**

Tel. 976 464 101  
Fax 976 464 105  
almacen@dicsaes.com

# DICSA

DISTRIBUIDORA INTERNACIONAL CARMEN, S.A.  
Polígono Industrial Alcalde Caballero  
C/ Virgen del Buen Acuerdo, s/n.º. 50014 Zaragoza (Spain)

Tel.: + 34 976 464 100  
Fax: + 34 976 464 104

[info@dicsaes.com](mailto:info@dicsaes.com)  
[www.dicsaes.com](http://www.dicsaes.com)

Sucursal / Filiale / Branch Office / Filiale  
**DICSA SRL**  
Via Emilia Ovest, 1179/c  
41123 Modena (ITALIA)

Tel.: +39 059 820 179  
Fax: +39 059 336 52 59

[italia@dicsaes.com](mailto:italia@dicsaes.com)

